

**NOTICE!!**

**These documents have been scanned!**

**Do not place un-scanned documents beneath this notice!**

**Do not remove this notice from this file!**

GPO Jacket No. 560-102  
Print Order 61540  
Rise Business Services, LLC  
Job=AZ15 5/8/2019



Box Number= AZ15026



Claim Begin-End: AMC432120-AMC432235

1 Initial Receipt



AZ15026-5

AMC431791-AMC432478

AMC#	DATE CLOSED	REMARKS
432120		
432121		
432122		
432123		
432124		
432125		
432126		
432127		
432128		
432129		
432130		
432131		
432132		
432133		
432134		
432135		
432136		
432137		
432138		
432139		



AMC#	DATE CLOSED	REMARKS
432140		
432141		
432142		
432143		
432144		
432145		
432146		
432147		
432148		
432149		
432150		
432151		
432152		
432153		
432154		
432155		
432156		
432157		
432158		
432159		

AMC#	DATE CLOSED	REMARKS
432 160		
432 161		
432 162		
432 163		
432 164		
432 165		
432 166		
432 167		
432 168		
432 169		
432 170		
432 171		
432 172		
432 173		
432 174		
432 175		
432 176		
432 177		
432 178		
432 179		



AMC#	DATE CLOSED	REMARKS
432180		
432181		
432182		
432183		
432184		
432185		
432186		
432187		
432188		
432189		
432190		
432191		
432192		
432193		
432194		
432195		
432196		
432197		
432198		
432199		

AMC#	DATE CLOSED	REMARKS
432 200		
432 201		
432 202		
432 203		
432 204		
432 205		
432 206		
432 207		
432 208		
432 209		
432 210		
432 211		
432 212		
432 213		
432 214		
432 215		
432 216		
432 217		
432 218		
432 219		

AMC#	DATE CLOSED	REMARKS
432 220		
432 221		
432 222		
432 223		
432 224		
432 225		
432 226		
432 227		
432 228		
432 229		
432 230		
432 231		
432 232		
432 233		
432 234		
432 235		



**United States Department of the Interior**  
**Bureau of Land Management**  
 LANDS/RECREATION & PLANNING  
 ONE N CENTRAL AVE  
 PHOENIX, AZ 85004 -2203  
 Phone: 602-417-9200

Receipt

No: 3289892

<b>Transaction #:</b> 3386548	
<b>Date of Transaction:</b> 05/06/2015	
CUSTOMER:	
	FREEPORT MINERALS CORP PO BOX 1019 SAFFORD, AZ 85548-1019 US

ENTERED  
MAY 15 2015  
 BY: Rutan

LINE #	QTY	DESCRIPTION	REMARKS	UNIT PRICE	TOTAL
1	116.00	LOCATABLE MINERALS / MINING CLAIMS- NEW, UNADJUD, ONE OR MORE AUTH NOS / NEW MINING CLAIMS LOCATION FEE <b>CASES:</b> AMC432120/\$37.00, AMC432121/\$37.00, AMC432122/\$37.00, AMC432123/\$37.00, AMC432124/\$37.00, AMC432125/\$37.00, AMC432126/\$37.00, AMC432127/\$37.00, AMC432128/\$37.00, AMC432129/\$37.00, AMC432130/\$37.00, AMC432131/\$37.00, AMC432132/\$37.00, AMC432133/\$37.00, AMC432134/\$37.00, AMC432135/\$37.00, AMC432136/\$37.00, AMC432137/\$37.00, AMC432138/\$37.00, AMC432139/\$37.00, AMC432140/\$37.00, AMC432141/\$37.00, AMC432142/\$37.00, AMC432143/\$37.00, AMC432144/\$37.00, AMC432145/\$37.00, AMC432146/\$37.00, AMC432147/\$37.00, AMC432148/\$37.00, AMC432149/\$37.00, AMC432150/\$37.00, AMC432151/\$37.00, AMC432152/\$37.00, AMC432153/\$37.00, AMC432154/\$37.00, AMC432155/\$37.00, AMC432156/\$37.00, AMC432157/\$37.00, AMC432158/\$37.00, AMC432159/\$37.00, AMC432160/\$37.00, AMC432161/\$37.00, AMC432162/\$37.00, AMC432163/\$37.00, AMC432164/\$37.00, AMC432165/\$37.00, AMC432166/\$37.00, AMC432167/\$37.00, AMC432168/\$37.00, AMC432169/\$37.00, AMC432170/\$37.00, AMC432171/\$37.00, AMC432172/\$37.00, AMC432173/\$37.00, AMC432174/\$37.00, AMC432175/\$37.00,		- n/a -	4292.00

	<p>AMC432176/\$37.00, AMC432177/\$37.00,  AMC432178/\$37.00, AMC432179/\$37.00,  AMC432180/\$37.00, AMC432181/\$37.00,  AMC432182/\$37.00, AMC432183/\$37.00,  AMC432184/\$37.00, AMC432185/\$37.00,  AMC432186/\$37.00, AMC432187/\$37.00,  AMC432188/\$37.00, AMC432189/\$37.00,  AMC432190/\$37.00, AMC432191/\$37.00,  AMC432192/\$37.00, AMC432193/\$37.00,  AMC432194/\$37.00, AMC432195/\$37.00,  AMC432196/\$37.00, AMC432197/\$37.00,  AMC432198/\$37.00, AMC432199/\$37.00,  AMC432200/\$37.00, AMC432201/\$37.00,  AMC432202/\$37.00, AMC432203/\$37.00,  AMC432204/\$37.00, AMC432205/\$37.00,  AMC432206/\$37.00, AMC432207/\$37.00,  AMC432208/\$37.00, AMC432209/\$37.00,  AMC432210/\$37.00, AMC432211/\$37.00,  AMC432212/\$37.00, AMC432213/\$37.00,  AMC432214/\$37.00, AMC432215/\$37.00,  AMC432216/\$37.00, AMC432217/\$37.00,  AMC432218/\$37.00, AMC432219/\$37.00,  AMC432220/\$37.00, AMC432221/\$37.00,  AMC432222/\$37.00, AMC432223/\$37.00,  AMC432224/\$37.00, AMC432225/\$37.00,  AMC432226/\$37.00, AMC432227/\$37.00,  AMC432228/\$37.00, AMC432229/\$37.00,  AMC432230/\$37.00, AMC432231/\$37.00,  AMC432232/\$37.00, AMC432233/\$37.00,  AMC432234/\$37.00, AMC432235/\$37.00</p>			
2	<p>LOCATABLE MINERALS / MINING CLAIMS-  NEW, UNADJUD, ONE OR MORE AUTH NOS /  NEW MINING CLAIM PROCESSING FEE  <b>CASES:</b> AMC432120/\$20.00, AMC432121/\$20.00,  AMC432122/\$20.00, AMC432123/\$20.00,  AMC432124/\$20.00, AMC432125/\$20.00,  AMC432126/\$20.00, AMC432127/\$20.00,  AMC432128/\$20.00, AMC432129/\$20.00,  AMC432130/\$20.00, AMC432131/\$20.00,  AMC432132/\$20.00, AMC432133/\$20.00,  AMC432134/\$20.00, AMC432135/\$20.00,  AMC432136/\$20.00, AMC432137/\$20.00,  AMC432138/\$20.00, AMC432139/\$20.00,  AMC432140/\$20.00, AMC432141/\$20.00,  AMC432142/\$20.00, AMC432143/\$20.00,  AMC432144/\$20.00, AMC432145/\$20.00,  AMC432146/\$20.00, AMC432147/\$20.00,  AMC432148/\$20.00, AMC432149/\$20.00,  AMC432150/\$20.00, AMC432151/\$20.00,  AMC432152/\$20.00, AMC432153/\$20.00,</p>			

116.00	AMC432154/\$20.00, AMC432155/\$20.00, AMC432156/\$20.00, AMC432157/\$20.00, AMC432158/\$20.00, AMC432159/\$20.00, AMC432160/\$20.00, AMC432161/\$20.00, AMC432162/\$20.00, AMC432163/\$20.00, AMC432164/\$20.00, AMC432165/\$20.00, AMC432166/\$20.00, AMC432167/\$20.00, AMC432168/\$20.00, AMC432169/\$20.00, AMC432170/\$20.00, AMC432171/\$20.00, AMC432172/\$20.00, AMC432173/\$20.00, AMC432174/\$20.00, AMC432175/\$20.00, AMC432176/\$20.00, AMC432177/\$20.00, AMC432178/\$20.00, AMC432179/\$20.00, AMC432180/\$20.00, AMC432181/\$20.00, AMC432182/\$20.00, AMC432183/\$20.00, AMC432184/\$20.00, AMC432185/\$20.00, AMC432186/\$20.00, AMC432187/\$20.00, AMC432188/\$20.00, AMC432189/\$20.00, AMC432190/\$20.00, AMC432191/\$20.00, AMC432192/\$20.00, AMC432193/\$20.00, AMC432194/\$20.00, AMC432195/\$20.00, AMC432196/\$20.00, AMC432197/\$20.00, AMC432198/\$20.00, AMC432199/\$20.00, AMC432200/\$20.00, AMC432201/\$20.00, AMC432202/\$20.00, AMC432203/\$20.00, AMC432204/\$20.00, AMC432205/\$20.00, AMC432206/\$20.00, AMC432207/\$20.00, AMC432208/\$20.00, AMC432209/\$20.00, AMC432210/\$20.00, AMC432211/\$20.00, AMC432212/\$20.00, AMC432213/\$20.00, AMC432214/\$20.00, AMC432215/\$20.00, AMC432216/\$20.00, AMC432217/\$20.00, AMC432218/\$20.00, AMC432219/\$20.00, AMC432220/\$20.00, AMC432221/\$20.00, AMC432222/\$20.00, AMC432223/\$20.00, AMC432224/\$20.00, AMC432225/\$20.00, AMC432226/\$20.00, AMC432227/\$20.00, AMC432228/\$20.00, AMC432229/\$20.00, AMC432230/\$20.00, AMC432231/\$20.00, AMC432232/\$20.00, AMC432233/\$20.00, AMC432234/\$20.00, AMC432235/\$20.00	- n/a -	2320.00
	LOCATABLE MINERALS / MINING CLAIMS- NEW, UNADJUD, ONE OR MORE AUTH NOS / NEW MINING CLAIMS MAINTENANCE FEE <b>CASES:</b> AMC432120/\$155.00, AMC432121/\$155.00, AMC432122/\$155.00, AMC432123/\$155.00, AMC432124/\$155.00, AMC432125/\$155.00, AMC432126/\$155.00, AMC432127/\$155.00, AMC432128/\$155.00, AMC432129/\$155.00, AMC432130/\$155.00, AMC432131/\$155.00,		

3

116.00

AMC432132/\$155.00, AMC432133/\$155.00,  
 AMC432134/\$155.00, AMC432135/\$155.00,  
 AMC432136/\$155.00, AMC432137/\$155.00,  
 AMC432138/\$155.00, AMC432139/\$155.00,  
 AMC432140/\$155.00, AMC432141/\$155.00,  
 AMC432142/\$155.00, AMC432143/\$155.00,  
 AMC432144/\$155.00, AMC432145/\$155.00,  
 AMC432146/\$155.00, AMC432147/\$155.00,  
 AMC432148/\$155.00, AMC432149/\$155.00,  
 AMC432150/\$155.00, AMC432151/\$155.00,  
 AMC432152/\$155.00, AMC432153/\$155.00,  
 AMC432154/\$155.00, AMC432155/\$155.00,  
 AMC432156/\$155.00, AMC432157/\$155.00,  
 AMC432158/\$155.00, AMC432159/\$155.00,  
 AMC432160/\$155.00, AMC432161/\$155.00,  
 AMC432162/\$155.00, AMC432163/\$155.00,  
 AMC432164/\$155.00, AMC432165/\$155.00,  
 AMC432166/\$155.00, AMC432167/\$155.00,  
 AMC432168/\$155.00, AMC432169/\$155.00,  
 AMC432170/\$155.00, AMC432171/\$155.00,  
 AMC432172/\$155.00, AMC432173/\$155.00,  
 AMC432174/\$155.00, AMC432175/\$155.00,  
 AMC432176/\$155.00, AMC432177/\$155.00,  
 AMC432178/\$155.00, AMC432179/\$155.00,  
 AMC432180/\$155.00, AMC432181/\$155.00,  
 AMC432182/\$155.00, AMC432183/\$155.00,  
 AMC432184/\$155.00, AMC432185/\$155.00,  
 AMC432186/\$155.00, AMC432187/\$155.00,  
 AMC432188/\$155.00, AMC432189/\$155.00,  
 AMC432190/\$155.00, AMC432191/\$155.00,  
 AMC432192/\$155.00, AMC432193/\$155.00,  
 AMC432194/\$155.00, AMC432195/\$155.00,  
 AMC432196/\$155.00, AMC432197/\$155.00,  
 AMC432198/\$155.00, AMC432199/\$155.00,  
 AMC432200/\$155.00, AMC432201/\$155.00,  
 AMC432202/\$155.00, AMC432203/\$155.00,  
 AMC432204/\$155.00, AMC432205/\$155.00,  
 AMC432206/\$155.00, AMC432207/\$155.00,  
 AMC432208/\$155.00, AMC432209/\$155.00,  
 AMC432210/\$155.00, AMC432211/\$155.00,  
 AMC432212/\$155.00, AMC432213/\$155.00,  
 AMC432214/\$155.00, AMC432215/\$155.00,  
 AMC432216/\$155.00, AMC432217/\$155.00,  
 AMC432218/\$155.00, AMC432219/\$155.00,  
 AMC432220/\$155.00, AMC432221/\$155.00,  
 AMC432222/\$155.00, AMC432223/\$155.00,  
 AMC432224/\$155.00, AMC432225/\$155.00,  
 AMC432226/\$155.00, AMC432227/\$155.00,  
 AMC432228/\$155.00, AMC432229/\$155.00,  
 AMC432230/\$155.00, AMC432231/\$155.00,

- n/a - 17980.00

		AMC432232/\$155.00, AMC432233/\$155.00, AMC432234/\$155.00, AMC432235/\$155.00			
4	1.00	LOCATABLE MINERALS / MINING CLAIMS- NOT NEW-UNADJUD, ONE AUTH NO. ONLY / MINING CLAIM MONEY RECEIVED CASES: AMC432120/\$17980.00	MAINT FEE PYMNT (116) 2016	- n/a -	17980.00
<b>TOTAL:</b>					<b>\$42,572.00</b>

PAYMENT INFORMATION				
1	AMOUNT:	42572.00	POSTMARKED:	05/06/2015
	TYPE:	CHECK	RECEIVED:	05/06/2015
	CHECK NO:	0000838512		
	NAME:	FREEPORT-MCMORAN INC 333 N CENTRAL AVE PHOENIX AZ 85004 US		

REMARKS

This receipt was generated by the automated BLM Collections and Billing System and is a paper representation of a portion of the official electronic record contained therein.



**NOTICE!!**

**These documents have been scanned!**

**Do not place un-scanned documents beneath this notice!**

**Do not remove this notice from this file!**

GPO Jacket No. 560-102  
Print Order 61540  
Rise Business Services, LLC  
Job=AZ15 5/8/2019



Box Number= AZ15026



Claim Begin-End: AMC432120-AMC432235

2 Correspondence



AZ15026-5

AMC431791-AMC432478



# United States Department of the Interior



BUREAU OF LAND MANAGEMENT

Arizona State Office

One North Central Avenue, Suite 800

Phoenix, Arizona 85004-4427

[www.blm.gov/az/](http://www.blm.gov/az/)

OCT 21 2020

In Reply Refer To:

3800 (9200) RM

AMC431317, AMC432120

CERTIFIED MAIL - RETURN RECEIPT REQUESTED No. 9214 8901 9403 8323 3303 29

## DECISION

SOUTHWEST EXPLORATION LLC	:	This decision affects those claims
580 S PROSPECTORS RD	:	shown on the attached list(s).
APACHE JUNCTION, AZ 85119-8828	:	

---

SEE ATTACHMENT(S) FOR CLAIM NAMES AND AMC NUMBERS

---

## MINING CLAIMS DECLARED FORFEITED

The mining claims listed above have been declared forfeited as of September 1, 2020, for failure to timely file the required maintenance fee payment or small miner's maintenance fee waiver (waiver).

Claimants are required to pay an annual non-refundable maintenance fee of \$165 per 20 acres or portion thereof, or submit a waiver, on or before September 1 of each year. These requirements were established by 30 U.S.C. 28f-1, as amended, and 43 CFR 3834 and 3835.

Our records do not show receipt of a maintenance fee payment or small miner waiver filed on or before the due date. Therefore, the claims listed above are forfeited.

## Reclamation Requirements

This decision does not relieve you of the liability for reclamation of all areas disturbed by your activities on lands covered by the subject mining claim(s) and/or site(s). After you complete the reclamation, you must notify the authorized officer of the appropriate surface managing agency so that the authorized officer may conduct a final site inspection and determine whether you may



be released from liability. If you fail to reclaim the land to the satisfaction of the authorized officer, the surface management agency may cite you for noncompliance under its surface management regulations. For land administered by the Bureau of Land Management (BLM), if you fail to reclaim the land to the satisfaction of the authorized officer as required in 43 CFR Subpart 3809, the BLM will issue an order of noncompliance under 43 CFR 3809.601(a). If you fail to comply with the non-compliance order, BLM may take further action under 43 CFR 3809.604. Failure to conduct reclamation is a prohibited act that may subject you to criminal penalties. See 43 CFR 3809.605(h) and 43 CFR 3809.700.

### Appeal Procedures

This decision may be appealed to the Interior Board of Land Appeals, Office of the Secretary, in accordance with the regulations contained in 43 CFR, Part 4, and the enclosed Form 1842-1. If an appeal is taken, your notice of appeal must be filed in this office (at the above address) within 30 days from receipt of this decision. The appellant has the burden of showing that the decision appealed from is in error.

If you wish to file a petition pursuant to regulation 43 CFR 4.21 (58 FR 4939, January 19, 1993) for a stay of the effectiveness of this decision during the time that your appeal is being reviewed by the Board, the petition for a stay must accompany your notice of appeal. A petition for a stay is required to show sufficient justification based on the standards listed below. Copies of the notice of appeal and petition for a stay **must** also be submitted to each party named in this decision and to the Interior Board of Land Appeals and to the appropriate Office of the Solicitor (see 43 CFR 4.413) at the same time the original documents are filed with this office. If you request a stay, you have the burden of proof to demonstrate that a stay should be granted.

### Standards for Obtaining a Stay

Except as otherwise provided by law or other pertinent regulation, a petition for a stay of a decision pending appeal shall show sufficient justification based on the following standards:

- (1) The relative harm to the parties if the stay is granted or denied,
- (2) The likelihood of the appellant's success on the merits,
- (3) The likelihood of immediate and irreparable harm if the stay is not granted, and
- (4) Whether the public interest favors granting the stay.

Please include your AMC serial number(s) on all correspondence. If additional information is required, please call RéAnn Myers at 602-417-9413.

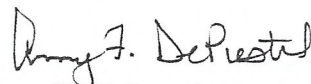

Amy F. DePestel  
Supervisory Land Law Examiner  
Lands, Minerals and Energy Division

Enclosure(s)

SOUTHWEST EXPLORATION LLC  
580 S PROSPECTORS RD  
APACHE JUNCTION AZ 85119-8828

<u>LEAD FILE NUMBER</u>	<u>CLAIM NUMBER</u>	<u>CLAIM NAME</u>
AMC431317	AMC431506	RED BULL - 397
AMC431317	AMC431507	RED BULL - 398
AMC431317	AMC431515	RED BULL - 406
AMC431317	AMC431516	RED BULL - 407
AMC431317	AMC431524	RED BULL - 415
AMC431317	AMC431525	RED BULL - 416
AMC431317	AMC431533	RED BULL - 424
AMC431317	AMC431534	RED BULL - 425
AMC432120	AMC432143	RED BULL-438
AMC432120	AMC432144	RED BULL-439
AMC432120	AMC432145	RED BULL-440
AMC432120	AMC432146	RED BULL-441
AMC432120	AMC432152	RED BULL-447
AMC432120	AMC432153	RED BULL-448
AMC432120	AMC432154	RED BULL-449
AMC432120	AMC432155	RED BULL-450
AMC432120	AMC432161	RED BULL-456
AMC432120	AMC432162	RED BULL-457
AMC432120	AMC432163	RED BULL-458
AMC432120	AMC432164	RED BULL-459
AMC432120	AMC432170	RED BULL-465
AMC432120	AMC432171	RED BULL-466
AMC432120	AMC432172	RED BULL-467
AMC432120	AMC432173	RED BULL-468



Date Produced: 10/26/2020

ConnectSuite Inc.:

The following is the delivery information for Certified Mail™/RRE item number 9214 8901 9403 8323 3303 29. Our records indicate that this item was delivered on 10/24/2020 at 02:11 p.m. in APACHE JUNCTION, AZ 85119. The scanned image of the recipient information is provided below.

Signature of Recipient :

D. LAW  
TN RAIL C-19

Address of Recipient :

580  
Prosperity

Thank you for selecting the Postal Service for your mailing needs. If you require additional assistance, please contact your local post office or Postal Service representative.

Sincerely,  
United States Postal Service

The customer reference number shown below is not validated or endorsed by the United States Postal Service. It is solely for customer use.

Customer Reference Number: C2329039.13257679



**SENDER: COMPLETE THIS SECTION**

- Complete items 1, 2, and 3.
- Print your name and address on the reverse so that we can return the card to you.
- Attach this card to the back of the mailpiece, or on the front if space permits.

1. Article Addressed to:

SOUTHWEST EXPLORATION LLC  
 580 S PROSPECTORS RD  
 APACHE JUNCTION AZ 85119-8828  
 9200/RM/AMC432120, AMC433439



9590 9402 1932 6123 9410 72

2. Article Number (Transfer from service label)

7014 2870 0000 1116 1391

**COMPLETE THIS SECTION ON DELIVERY**

A. Signature

**X** Agent Addressee

B. Received by (Printed Name)

C. Date of Delivery

 D. Is delivery address different from item 1?  Yes  
 If YES, enter delivery address below:  No

3. Service Type

- Adult Signature
- Adult Signature Restricted Delivery
- Certified Mail®
- Certified Mail Restricted Delivery
- Collect on Delivery
- Collect on Delivery Restricted Delivery
- Registered Mail
- Registered Mail Restricted Delivery (over \$500)

- Priority Mail Express®
- Registered Mail™
- Registered Mail Restricted Delivery
- Return Receipt for Merchandise
- Signature Confirmation™
- Signature Confirmation Restricted Delivery

USPS TRACKING#



First-Class Mail  
Postage & Fees Paid  
USPS  
Permit No. G-10

9590 9402 1932 6123 9410 72

United States  
Postal Service

RECEIVED  
BLM AZ STATE OFFICE

• Sender: Please print your name, address, and ZIP+4® in this box •

2011 NOV - 3 P 2:5

PHOENIX, AZ

U.S. DEPARTMENT OF THE INTERIOR  
BUREAU OF LAND MANAGEMENT  
ARIZONA STATE OFFICE  
ONE NORTH CENTRAL AVENUE, SUITE 800  
PHOENIX, AZ 85004-4427

4-442700

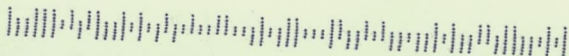



# United States Department of the Interior



BUREAU OF LAND MANAGEMENT

Arizona State Office

One North Central Avenue, Suite 800

Phoenix, Arizona 85004-4427

[www.blm.gov/az/](http://www.blm.gov/az/)

NOV 02 2017

In Reply Refer To:

3800 (9200) RM

AMC432120, AMC433439

CERTIFIED MAIL - RETURN RECEIPT REQUESTED No. 7014 2870 0000 1116 1391

## DECISION

SOUTHWEST EXPLORATION LLC :  
580 S PROSPECTORS RD :  
APACHE JUNCTION, AZ 85119-8828 :

This decision affects those claims  
shown on the attached list(s).

---

SEE ENCLOSURE FOR LIST OF MINING CLAIMS

---

### MINING CLAIMS DECLARED FORFEIT

The mining claims listed above have been declared forfeit as of September 1, 2017, for failure to timely file the required maintenance fee payment or small miner's maintenance fee waiver (waiver).

Claimants are required to pay an annual non-refundable maintenance fee of \$155 per 20 acres or portion thereof, or submit a waiver, on or before September 1 of each year. These requirements were established by 30 U.S.C. 28f-1, as amended, and 43 CFR 3834 and 3835.

Our records do not show receipt of a maintenance fee payment or small miner waiver filed on or before the due date. Therefore, the claims listed above are forfeit.

### Reclamation Requirements

This decision does not relieve you of the liability for reclamation of all areas disturbed by your activities on lands covered by the subject mining claim(s) and/or site(s). After you complete the reclamation, you must notify the authorized officer of the appropriate surface managing agency so that the authorized officer may conduct a final site inspection and determine whether you may be released from liability. If you fail to reclaim the land to the satisfaction of the authorized officer, the surface management agency may cite you for noncompliance under its surface management regulations. For land administered by the Bureau of Land Management (BLM), if you fail to reclaim the land to the satisfaction of the authorized officer as required in 43 CFR Subpart 3809, the BLM will issue an order of noncompliance under 43 CFR 3809.601(a). If you fail to comply with the non-compliance order, BLM may take further action under 43 CFR 3809.604. Failure to conduct reclamation is a prohibited act that may subject you to criminal penalties. See 43 CFR 3809.605(h) and 43 CFR 3809.700.

## Appeal Procedures

This decision may be appealed to the Interior Board of Land Appeals, Office of the Secretary, in accordance with the regulations contained in 43 CFR, Part 4, and the enclosed Form 1842-1. If an appeal is taken, your notice of appeal must be filed in this office (at the above address) within 30 days from receipt of this decision. The appellant has the burden of showing that the decision appealed from is in error.

If you wish to file a petition pursuant to regulation 43 CFR 4.21 (58 FR 4939, January 19, 1993) for a stay of the effectiveness of this decision during the time that your appeal is being reviewed by the Board, the petition for a stay must accompany your notice of appeal. A petition for a stay is required to show sufficient justification based on the standards listed below. Copies of the notice of appeal and petition for a stay **must** also be submitted to each party named in this decision and to the Interior Board of Land Appeals and to the appropriate Office of the Solicitor (see 43 CFR 4.413) at the same time the original documents are filed with this office. If you request a stay, you have the burden of proof to demonstrate that a stay should be granted.

### Standards for Obtaining a Stay

Except as otherwise provided by law or other pertinent regulation, a petition for a stay of a decision pending appeal shall show sufficient justification based on the following standards:

- (1) The relative harm to the parties if the stay is granted or denied,
- (2) The likelihood of the appellant's success on the merits,
- (3) The likelihood of immediate and irreparable harm if the stay is not granted, and
- (4) Whether the public interest favors granting the stay.

Please include your AMC serial number(s) on all correspondence. If additional information is required, please call RéAnn Myers at 602-417-9413.



Lucas Lucero  
Deputy State Director  
Lands, Minerals and Energy Division

Enclosure(s)

SOUTHWEST EXPLORATION LLC  
580 S PROSPECTORS RD  
APACHE JUNCTION AZ 85119-8828

LEAD FILE

<u>NUMBER</u>	<u>CLAIM NUMBER</u>	<u>CLAIM NAME</u>
AMC432120	AMC432138	RED BULL-433
AMC432120	AMC432139	RED BULL-434
AMC432120	AMC432140	RED BULL-435
AMC432120	AMC432141	RED BULL-436
AMC432120	AMC432142	RED BULL-437
AMC432120	AMC432147	RED BULL-442
AMC432120	AMC432148	RED BULL-443
AMC432120	AMC432149	RED BULL-444
AMC432120	AMC432150	RED BULL-445
AMC432120	AMC432151	RED BULL-446
AMC432120	AMC432156	RED BULL-451
AMC432120	AMC432157	RED BULL-452
AMC432120	AMC432158	RED BULL-453
AMC432120	AMC432159	RED BULL-454
AMC432120	AMC432160	RED BULL-455
AMC432120	AMC432165	RED BULL-460
AMC432120	AMC432166	RED BULL-461
AMC432120	AMC432167	RED BULL-462
AMC432120	AMC432168	RED BULL-463
AMC432120	AMC432169	RED BULL-464
AMC433439	AMC433445	RED BULL - 687
AMC433439	AMC433446	RED BULL - 688
AMC433439	AMC433447	RED BULL - 689
AMC433439	AMC433454	RED BULL - 696
AMC433439	AMC433455	RED BULL - 697
AMC433439	AMC433456	RED BULL - 698
AMC433439	AMC433459	RED BULL - 701
AMC433439	AMC433460	RED BULL - 702
AMC433439	AMC433461	RED BULL - 703
AMC433439	AMC433462	RED BULL - 704
AMC433439	AMC433463	RED BULL - 705
AMC433439	AMC433464	RED BULL - 706
AMC433439	AMC433465	RED BULL - 707
AMC433439	AMC433466	RED BULL - 708
AMC433439	AMC433467	RED BULL - 709
AMC433439	AMC433468	RED BULL - 710





FAQs > (<http://faq.usps.com/?articleId=220900>)

### Track Another Package +

**Tracking Number:** 70142870000011161391



Remove X

Your item was delivered at 11:19 am on November 14, 2017 in APACHE JUNCTION, AZ 85120.

### **Delivered**

November 14, 2017 at 11:19 am  
DELIVERED  
APACHE JUNCTION, AZ 85120

Get Updates 

- Text & Email Updates** 
- Tracking History** 
- Product Information** 

See Less 

## Can't find what you're looking for?

Go to our **FAQs** (<http://faq.usps.com/?articleId=220900>) section to find answers to your tracking questions.

**NOTICE!!**

**These documents have been scanned!**

**Do not place un-scanned documents beneath this notice!**

**Do not remove this notice from this file!**

GPO Jacket No. 560-102  
Print Order 61540  
Rise Business Services, LLC  
Job=AZ15 5/8/2019



Box Number= AZ15026



Claim Begin-End: AMC432120-AMC432235

3 Transfers



AZ15026-5

AMC431791-AMC432478

LEAD FILE NUMBERS

AMC	46122	340956
	66892	341652
	101235	344109
	289500	430691
	292727	<del>430791</del>
	293492	430751
	294150	430889
	294346	431071
	298849	431121
	298861	431317
	298929	431566
	305755	431611
	321860	431791
	324229	431904
	324366	432120
	324842	432241
	326065	432443
	326786	432486
	329064	432621
	329094	432994
	330967	433439
	331727	441072
	333390	
	334772	
	340495	

ENTERED  
DEC 20 2017  
BY: *RM*

AMC 46122  
66892  
101235  
289500  
292727  
293492  
294150  
294346

298849  
298861  
298929  
305755  
321860

**QUIT CLAIM DEED**

Upon recording return to:  
Freeport McMoRan Safford Inc.  
8500 N. Freeport McMoRan Rd  
P.O. Box 1019  
Safford, Arizona 85548

RECEIVED  
2017 DEC 12 A 1:31  
PHOENIX, ARIZONA

Affidavit of Value exempt pursuant to A.R.S § 11-1134(A)(6)

**QUIT CLAIM DEED**  
**(Unpatented Mining Claims)**

For Ten Dollars (\$10.00) and other good and valuable consideration, the receipt and sufficiency of which is hereby acknowledged, **FREEPORT MINERALS CORPORATION**, a Delaware Corporation ("Grantor"), hereby quit-claim and release, to **FREEPORT MCMORAN SAFFORD INC.**, a Delaware corporation, all right, title or interest, if any, in the three thousand two hundred eighty four (3284) unpatented mining claims situated in the Lone Star Mining District, Graham County, Arizona (the "Claims") described on Exhibit "A" attached hereto.

[SIGNATURES ON FOLLOWING PAGE]

**ENTERED**  
DEC 20 2017  
BY: *[Signature]*

IN WITNESS WHEREOF, Grantor has executed this Quit Claim Deed as of this  
4<sup>TH</sup> day of December, 2017

**GRANTOR:**

**FREEPORT MINERALS CORPORATION, a  
Delaware corporation**

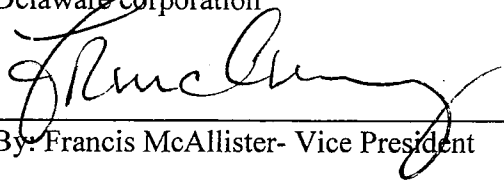
  
By: Francis McAllister- Vice President

STATE OF ARIZONA )  
County of MARICOPA ) SS.

The foregoing Quit Claim Deed dated the 4<sup>TH</sup> day of December, 2017, granted for the benefit of Freeport McMoRan Safford Inc., a Delaware corporation, consisting of a total of 78 pages, was acknowledged before me this 4<sup>TH</sup> day of December, 2017 by Francis McAllister as Vice President of Freeport Minerals Corporation, a Delaware corporation.

  
Notary Public

My commission expires: JAN. 31, 2021

STATE OF ARIZONA )  
County of MARICOPA ) SS.

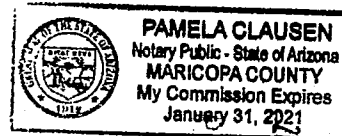

RECEIVED  
F.M.A.S. STAFF OFFICE  
2017 DEC 12 A 1:31  
PHOENIX, ARIZONA

**FREEPORT-McMoRAN**

Land & Water Department  
333 N. Central Ave., Phoenix, AZ 85004 • (602) 366-8100 • Fax: (602) 366-7305

Name: Bob Bigando  
Direct Line: (928) 792-5924  
E-mail: bbigando@fmi.com

December 7, 2017

**CERTIFIED MAIL - RETURN RECEIPT REQUESTED**

Bureau of Land Management  
U.S. Department of the Interior  
Arizona State Office  
One North Central Ave  
Phoenix, Arizona 85004

Attn: Mining Claims Section

**Re: Notice of Transfer of Interest – Mining Claims**

TO WHOM IT MAY CONCERN:

Pursuant to 43 CFR 3833.30, notice is hereby given that an interest in the mining claims and/or mill sites described in Exhibit A attached hereto was transferred via Quit Claim Deed on December 4, 2017, from Freeport-Minerals Corporation to:

Freeport-McMoRan Safford Inc.  
c/o Bob Bigando  
8500 N. Freeport McMoRan Rd.  
P.O. Box 1019  
Safford, Arizona 85548

Enclosed is our check payable to the Department of the Interior-Bureau of Land Management in payment of the processing fee of \$10.00 per claim or site, for a total of \$32,840.00.

Very truly yours,

  
Bob Bigando  
Resource Analyst

RB  
Encl.

RECEIVED  
BLM ARIZONA STATE OFFICE  
2017 DEC 12 A 1:31  
PHOENIX, ARIZONA

EXHIBIT A

<u>BLM Serial #</u>	<u>Claim Name</u>	<u>Document No.</u>	<u>Page No.</u>	<u>Amendment Doc No.</u>	<u>Amendment Page No.</u>	<u>Sec/Twp/Range</u>
AMC 046468	Jerico	82	548	531	522	SEC35-T06S-R27E
AMC 046469	Jerico No. 2	82	549	519	45	SEC35-T06S-R27E
AMC 067551	Senorbac 24A	44	433	415	301	SEC31-T05S-R27E
AMC 067557	Senorbac 30A	44	439	415	317	SEC31-T05S-R27E
AMC 067558	Senorbac 31A	44	440	415	329	SEC31-T05S-R27E
AMC 067561	Senorbac 35A	44	443	415	333	SEC31-T05S-R27E
AMC 067596	A-1A	41	242	410	469	SEC12-T06S-R26E
AMC 067615	Bush 32A	53	386	414	21	SEC14-T06S-R26E
AMC 067616	Bush 33A	53	387	414	23	SEC14-T06S-R26E
AMC 067617	Bush 34A	53	388	414	25	SEC14-T06S-R26E
AMC 067618	Bush 35A	53	389	414	27	SEC14-T06S-R26E
AMC 067619	Bush 36A	53	390	414	29	SEC14-T06S-R26E
AMC 067633	Con. Metals No. 20A	31	597	410	451	SEC12-T06S-R26E
AMC 067634	Coors A	41	241	410	471	SEC12-T06S-R26E
AMC 067637	Griesidieck A	45	5	410	473	SEC12-T06S-R26E
AMC 067642	Ithaca No. 20A	41	235	410	461	SEC12-T06S-R26E
AMC 067655	Pabst A	41	240	414	37	SEC14-T06S-R26E
AMC 067656	Schlitz A	41	246	414	35	SEC14-T06S-R26E
AMC 067657	Mas No. 9	249	269			SEC27-T06S-R26E
AMC 067658	Mas No. 10	249	270			SEC27-T06S-R26E
AMC 067659	Mas No. 11	249	271			SEC27-T06S-R26E
AMC 067660	Mas No. 12	249	272			SEC27-T06S-R26E
AMC 067661	Mas No. 13	249	273			SEC27-T06S-R26E
AMC 067662	Mas No. 14	249	274			SEC27-T06S-R26E
AMC 067663	Mas No. 15	249	275			SEC27-T06S-R26E
AMC 067664	Mas No. 16	249	276			SEC27-T06S-R26E
AMC 067665	Mas No. 17	249	277			SEC27-T06S-R26E
AMC 067666	Mas No. 18	249	278			SEC27-T06S-R26E
AMC 067667	Mas No. 19	249	279			SEC34-T06S-R26E
AMC 067668	Mas No. 20	249	280			SEC34-T06S-R26E
AMC 067669	Mas No. 21	249	281			SEC34-T06S-R26E
AMC 067670	Mas No. 22	249	282			SEC34-T06S-R26E
AMC 067671	Mas No. 23	249	283			SEC34-T06S-R26E
AMC 067672	Mas No. 24	249	284			SEC34-T06S-R26E
AMC 067673	Mas No. 25	249	285			SEC34-T06S-R26E
AMC 067674	Mas No. 26	249	286			SEC34-T06S-R26E
AMC 067675	Mas No. 27	249	287			SEC34-T06S-R26E
AMC 067676	Mas No. 28	249	288			SEC34-T06S-R26E
AMC 067677	Mas No. 29	249	289			SEC34-T06S-R26E
AMC 067678	Mas No. 30	249	290			SEC34-T06S-R26E
AMC 067679	Mas No. 31	249	291			SEC34-T06S-R26E
AMC 067680	Mas No. 32	249	292			SEC34-T06S-R26E
AMC 067681	Mas No. 33	249	293			SEC34-T06S-R26E
AMC 067682	Mas No. 34	249	294			SEC34-T06S-R26E

RECEIVED  
 JAN 21 2011  
 SEC 34 TWP 6S R26E  
 AMERICAN  
 NATIONAL  
 ARCHIVE





EXHIBIT A

AMC 067730	Mas No. 90	249	342			SEC33-T06S-R26E
AMC 067731	Mas No. 91	249	343			SEC33-T06S-R26E
AMC 067732	Mas No. 92	249	344			SEC33-T06S-R26E
AMC 067733	Mas No. 93	249	345			SEC33-T06S-R26E
AMC 067734	Mas No. 94	249	346			SEC33-T06S-R26E
AMC 067735	Mas No. 96	249	348			SEC33-T06S-R26E
AMC 067736	Mas No. 98	249	349			SEC33-T06S-R26E
AMC 067737	Mas No. 100	249	350			SEC33-T06S-R26E
AMC 067750	Epsilon No. 51	51	38			SEC09-T06S-R27E
AMC 067767	Garoga 16A	46	61	416	972	SEC10-T06S-R27E
AMC 067772	Garoga #21	46	56			SEC10-T06S-R27E
AMC 067773	Garoga #22	46	55			SEC10-T06S-R27E
AMC 067774	Garoga #23	46	54			SEC10-T06S-R27E
AMC 067775	Garoga #24	46	53			SEC10-T06S-R27E
AMC 067776	Garoga #25	46	52			SEC10-T06S-R27E
AMC 067829	Alpha 61A	46	22	420	29	SEC20-T06S-R27E
AMC 067831	Alpha 63A	46	24	420	33	SEC20-T06S-R27E
AMC 067833	Alpha 65A	46	26	420	37	SEC20-T06S-R27E
AMC 067835	Alpha 67A	46	28	420	41	SEC20-T06S-R27E
AMC 067837	Alpha #69	46	30			SEC20-T06S-R27E
AMC 067839	Alpha #71	46	32			SEC20-T06S-R27E
AMC 067841	Alpha #73	46	34			SEC20-T06S-R27E
AMC 101253	Ace 19A	324	272	414	31	SEC14-T06S-R26E
AMC 101254	Ace 20A	324	274	414	33	SEC14-T06S-R26E
AMC 101282	Ace 48A	324	330	410	397	SEC11-T06S-R26E
AMC 101283	Ace 49A	324	332	410	399	SEC11-T06S-R26E
AMC 101284	Ace 50A	324	334	410	401	SEC11-T06S-R26E
AMC 101285	Ace 51A	324	336	478	241	SEC11-T06S-R26E
AMC 101286	Ace 52A	324	338	478	243	SEC11-T06S-R26E
AMC 289500	LS-21	410	379			SEC14-T06S-R26E
AMC 289501	LS-22	410	381			SEC11-T06S-R26E
AMC 292727	AZCO #1 Amended	413	128	512	669	SEC33-T06S-R27E
AMC 292728	AZCO #2 Amended	413	130	512	671	SEC04-T07S-R27E
AMC 292729	AZCO #3 Amended	413	132	512	673	SEC33-T06S-R27E
AMC 292730	AZCO #4 Amended	413	134	512	675	SEC04-T07S-R27E
AMC 292731	AZCO #5 Amended	413	136	512	677	SEC33-T06S-R27E
AMC 292732	AZCO #6 Amended	413	138	512	679	SEC04-T07S-R27E
AMC 292733	AZCO #7 Amended	413	140	512	681	SEC33-T06S-R27E
AMC 292734	AZCO #8 Amended	413	142	512	683	SEC04-T07S-R27E
AMC 292735	AZCO #9 Amended	413	144	512	685	SEC33-T06S-R27E
AMC 292736	AZCO #10 Amended	413	146	512	687	SEC04-T07S-R27E
AMC 292737	AZCO #11 Amended	413	148	512	689	SEC33-T06S-R27E
AMC 292738	AZCO #12 Amended	413	150	512	691	SEC04-T07S-R27E
AMC 292739	AZCO #13 Amended	413	152	512	693	SEC33-T06S-R27E
AMC 292740	AZCO #14 Amended	413	154	512	695	SEC04-T07S-R27E
AMC 292741	AZCO #15 Amended	413	156	512	697	SEC33-T06S-R27E
AMC 292742	AZCO #16 Amended	413	158	512	699	SEC04-T07S-R27E

PUBLIC RECORDS DIVISION  
 ARIZONA  
 2011

EXHIBIT A

AMC 292743	AZCO #17 Amended	413	160	512	701	SEC33-T06S-R27E
AMC 292744	AZCO #18 Amended	413	162	512	703	SEC04-T07S-R27E
AMC 292759	AZCO #33 Amended	413	192	512	705	SEC33-T06S-R27E
AMC 292760	AZCO #34 Amended	413	194	512	707	SEC33-T06S-R27E
AMC 292761	AZCO #35 Amended	413	196	512	709	SEC33-T06S-R27E
AMC 292762	AZCO #36 Amended	413	198	512	711	SEC33-T06S-R27E
AMC 292763	AZCO #37 Amended	413	200	512	713	SEC33-T06S-R27E
AMC 292764	AZCO #38 Amended	413	202	512	715	SEC33-T06S-R27E
AMC 292765	AZCO #100 Amended	413	204	512	731	SEC33-T06S-R27E
AMC 292766	AZCO #101 Amended	413	206	512	733	SEC33-T06S-R27E
AMC 292767	AZCO #102 Amended	413	208	512	735	SEC33-T06S-R27E
AMC 292768	AZCO #103 Amended	413	210	512	737	SEC33-T06S-R27E
AMC 292769	AZCO #104 Amended	413	212	512	739	SEC33-T06S-R27E
AMC 292770	AZCO #105 Amended	413	214	512	741	SEC33-T06S-R27E
AMC 292771	AZCO #106 Amended	413	216	512	743	SEC33-T06S-R27E
AMC 292772	AZCO #107 Amended	413	218	512	745	SEC33-T06S-R27E
AMC 292773	AZCO #108 Amended	413	220	512	747	SEC33-T06S-R27E
AMC 292774	AZCO #109 Amended	413	222	512	749	SEC33-T06S-R27E
AMC 292775	AZCO #110 Amended	413	224	512	751	SEC33-T06S-R27E
AMC 292776	AZCO #111 Amended	413	226	512	753	SEC33-T06S-R27E
AMC 292777	AZCO #112 Amended	413	228	512	755	SEC33-T06S-R27E
AMC 292778	AZCO #113 Amended	413	230	512	757	SEC33-T06S-R27E
AMC 292791	AZCO #126 Amended	413	256	512	759	SEC27-T06S-R27E
AMC 292792	AZCO #127 Amended	413	258	512	761	SEC27-T06S-R27E
AMC 292793	AZCO #128 Amended	413	260	512	763	SEC34-T06S-R27E
AMC 292794	AZCO #129 Amended	413	262	512	765	SEC34-T06S-R27E
AMC 292795	AZCO #130 Amended	413	264	512	767	SEC34-T06S-R27E
AMC 292796	AZCO #131 Amended	413	266	512	769	SEC34-T06S-R27E
AMC 292797	AZCO #132 Amended	413	268	512	771	SEC34-T06S-R27E
AMC 292798	AZCO #133 Amended	413	270	512	773	SEC34-T06S-R27E
AMC 292799	AZCO #134 Amended	413	272	512	775	SEC34-T06S-R27E
AMC 292800	AZCO #135 Amended	413	274	512	777	SEC34-T06S-R27E
AMC 292801	AZCO #136 Amended	413	276	512	779	SEC34-T06S-R27E
AMC 292802	AZCO #137 Amended	413	278	512	781	SEC34-T06S-R27E
AMC 292803	AZCO #138 Amended	413	280	512	783	SEC34-T06S-R27E
AMC 292804	AZCO #139 Amended	413	282	512	785	SEC34-T06S-R27E
AMC 292809	AZCO #144 Amended	413	292	512	787	SEC34-T06S-R27E
AMC 292810	AZCO #145 Amended	413	294	512	789	SEC34-T06S-R27E
AMC 292811	AZCO #146 Amended	413	296	512	791	SEC34-T06S-R27E
AMC 292812	AZCO #147 Amended	413	298	512	793	SEC34-T06S-R27E
AMC 292820	AZCO #155 Amended	413	314	512	795	SEC28-T06S-R27E
AMC 292822	AZCO #157 Amended	413	318	512	797	SEC28-T06S-R27E
AMC 292824	AZCO #159 Amended	413	322	512	799	SEC28-T06S-R27E
AMC 292826	AZCO #161 Amended	413	326	512	801	SEC28-T06S-R27E
AMC 292828	AZCO #163 Amended	413	330	512	803	SEC27-T06S-R27E
AMC 292829	AZCO #164 Amended	413	332	512	805	SEC27-T06S-R27E
AMC 292830	AZCO #165 Amended	413	334	512	807	SEC27-T06S-R27E

RECEIVED  
 2013  
 11  
 13

EXHIBIT A

AMC 292831	AZCO #166 Amended	413	336	512	809	SEC27-T06S-R27E
AMC 292832	AZCO #167 Amended	413	338	512	811	SEC27-T06S-R27E
AMC 292833	AZCO #168 Amended	413	340	512	813	SEC27-T06S-R27E
AMC 292834	AZCO #169 Amended	413	342	512	815	SEC27-T06S-R27E
AMC 292835	AZCO #170 Amended	413	344	512	817	SEC27-T06S-R27E
AMC 292836	AZCO #171 Amended	413	346	512	819	SEC27-T06S-R27E
AMC 292837	AZCO #172 Amended	413	348	512	821	SEC27-T06S-R27E
AMC 292838	AZCO #173 Amended	413	350	512	823	SEC27-T06S-R27E
AMC 292839	AZCO #174 Amended	413	352	512	825	SEC27-T06S-R27E
AMC 292840	AZCO #175 Amended	413	354	512	827	SEC27-T06S-R27E
AMC 292841	AZCO #176 Amended	413	356	512	829	SEC27-T06S-R27E
AMC 292842	AZCO #177 Amended	413	358	512	831	SEC27-T06S-R27E
AMC 292843	AZCO #178 Amended	413	360	512	833	SEC27-T06S-R27E
AMC 292844	AZCO #179 Amended	413	362	512	835	SEC27-T06S-R27E
AMC 292845	AZCO #180 Amended	413	364	512	837	SEC26-T06S-R27E
AMC 292846	AZCO #181 Amended	413	366	512	839	SEC26-T06S-R27E
AMC 292847	AZCO #182 Amended	413	368	512	841	SEC26-T06S-R27E
AMC 292848	AZCO #183 Amended	413	370	512	843	SEC26-T06S-R27E
AMC 292850	AZCO #195 Amended	413	374	512	857	SEC27-T06S-R27E
AMC 292851	AZCO #196 Amended	413	376	512	859	SEC26-T06S-R27E
AMC 292852	AZCO #197 Amended	413	378	512	861	SEC26-T06S-R27E
AMC 292853	AZCO #198 Amended	413	380	512	863	SEC26-T06S-R27E
AMC 292856	AZCO #202 Amended	413	386	512	865	SEC35-T06S-R27E
AMC 293498	LS-36	414	51			SEC14-T06S-R26E
AMC 294150	AZCO #39 Amended	415	9	512	717	SEC33-T06S-R27E
AMC 294151	AZCO #40 Amended	415	11	512	719	SEC33-T06S-R27E
AMC 294152	AZCO #41 Amended	415	13	512	721	SEC33-T06S-R27E
AMC 294153	AZCO #42 Amended	415	15	512	723	SEC33-T06S-R27E
AMC 294154	AZCO #43 Amended	415	17	512	725	SEC28-T06S-R27E
AMC 294155	AZCO #203 Amended	415	19	512	867	SEC28-T06S-R27E
AMC 294157	AZCO #205 Amended	415	23	512	869	SEC28-T06S-R27E
AMC 294159	AZCO #207 Amended	415	27	512	871	SEC28-T06S-R27E
AMC 294161	AZCO #209 Amended	415	31	512	873	SEC28-T06S-R27E
AMC 294167	AZCO #357 Amended	415	135	512	889	SEC24-T06S-R27E
AMC 294168	AZCO #359 Amended	415	137	512	893	SEC24-T06S-R27E
AMC 294169	AZCO #361 Amended	415	139	512	897	SEC24-T06S-R27E
AMC 294170	AZCO #363 Amended	415	141	512	901	SEC24-T06S-R27E
AMC 294171	AZCO #364 Amended	415	143	512	903	SEC24-T06S-R27E
AMC 294172	AZCO #365 Amended	415	145	512	905	SEC24-T06S-R27E
AMC 294173	AZCO #366 Amended	415	147	512	907	SEC24-T06S-R27E
AMC 294174	AZCO #367 Amended	415	149	512	909	SEC24-T06S-R27E
AMC 294175	AZCO #368 Amended	415	151	512	911	SEC23-T06S-R27E
AMC 294176	AZCO #369 Amended	415	153	512	913	SEC23-T06S-R27E
AMC 294177	AZCO #370 Amended	415	155	512	915	SEC23-T06S-R27E
AMC 294178	AZCO #371 Amended	415	157	512	917	SEC23-T06S-R27E
AMC 294179	AZCO #372 Amended	415	159	512	919	SEC23-T06S-R27E
AMC 294180	AZCO #373 Amended	415	161	512	921	SEC23-T06S-R27E

PUBLIC RECORDS DIVISION  
 ARIZONA  
 2011

EXHIBIT A

AMC 294181	AZCO #374 Amended	415	163	512	923	SEC23-T06S-R27E
AMC 294182	AZCO #375 Amended	415	165	512	925	SEC23-T06S-R27E
AMC 294183	AZCO #376 Amended	415	167	512	927	SEC23-T06S-R27E
AMC 294184	AZCO #377 Amended	415	169	512	929	SEC23-T06S-R27E
AMC 294185	AZCO #378 Amended	415	171	512	931	SEC23-T06S-R27E
AMC 294186	AZCO #379 Amended	415	173	512	933	SEC23-T06S-R27E
AMC 294187	AZCO #380 Amended	415	175	512	935	SEC23-T06S-R27E
AMC 294188	AZCO #381 Amended	415	177	512	937	SEC26-T06S-R27E
AMC 294189	AZCO #382 Amended	415	179	512	939	SEC26-T06S-R27E
AMC 294190	AZCO #383 Amended	415	181	512	941	SEC26-T06S-R27E
AMC 294191	AZCO #384 Amended	415	183	512	943	SEC26-T06S-R27E
AMC 294192	AZCO #300 Amended	415	43	512	875	SEC30-T06S-R27E
AMC 294193	AZCO #301 Amended	415	45	512	877	SEC30-T06S-R27E
AMC 294194	AZCO #302 Amended	415	47	512	879	SEC25-T06S-R27E
AMC 294195	AZCO #303 Amended	415	49	512	881	SEC25-T06S-R27E
AMC 294196	AZCO #304 Amended	415	51	512	883	SEC25-T06S-R27E
AMC 294197	AZCO #305 Amended	415	53	512	885	SEC30-T06S-R27E
AMC 294198	AZCO #306 Amended	415	55	512	887	SEC30-T06S-R27E
AMC 294348	LS-39	415	305			SEC31-T05S-R27E
AMC 294349	LS-40	415	319			SEC31-T05S-R27E
AMC 294350	LS-41	415	303			SEC31-T05S-R27E
AMC 298852	LS-53	419	998			SEC20-T06S-R27E
AMC 298855	LS-56	420	5			SEC20-T06S-R27E
AMC 298861	AZCO #44 Amended	419	636	512	727	SEC34-T06S-R27E
AMC 298862	AZCO #45 Amended	419	638	512	729	SEC34-T06S-R27E
AMC 298867	AZCO #185 Amended	419	634	512	845	SEC26-T06S-R27E
AMC 298868	AZCO #400 Amended	419	616	512	945	SEC36-T06S-R27E
AMC 298870	AZCO #402 Amended	419	620	512	947	SEC36-T06S-R27E
AMC 298876	AZCO #410 Amended	419	632	512	949	SEC36-T06S-R27E
AMC 298877	AZCO #411 Amended	419	648	512	951	SEC29-T06S-R27E
AMC 298878	AZCO #412 Amended	419	650	512	953	SEC29-T06S-R27E
AMC 298879	AZCO #413 Amended	419	652	512	955	SEC29-T06S-R27E
AMC 298880	AZCO #414 Amended	419	654	512	957	SEC29-T06S-R27E
AMC 298881	AZCO #415 Amended	419	656	512	959	SEC29-T06S-R27E
AMC 298882	AZCO #416 Amended	419	658	512	961	SEC29-T06S-R27E
AMC 298883	AZCO #417 Amended	419	660	512	963	SEC29-T06S-R27E
AMC 298884	AZCO #418 Amended	419	662	512	965	SEC29-T06S-R27E
AMC 298885	AZCO #419 Amended	419	664	512	967	SEC29-T06S-R27E
AMC 298886	AZCO #420 Amended	419	666	512	969	SEC29-T06S-R27E
AMC 298887	AZCO #421 Amended	419	668	512	971	SEC29-T06S-R27E
AMC 298888	AZCO #422 Amended	419	670	512	973	SEC29-T06S-R27E
AMC 298889	AZCO #423 Amended	419	672	512	975	SEC29-T06S-R27E
AMC 298890	AZCO #424 Amended	419	674	512	977	SEC29-T06S-R27E
AMC 298891	AZCO #425 Amended	419	676	512	979	SEC29-T06S-R27E
AMC 298892	AZCO #426 Amended	419	678	512	981	SEC29-T06S-R27E
AMC 298893	AZCO #427 Amended	419	680	512	983	SEC29-T06S-R27E
AMC 298894	AZCO #428 Amended	419	682	512	985	SEC29-T06S-R27E

2011 BE IN THE  
 PHOENIX, ARIZONA

EXHIBIT A

AMC 298895	AZCO #429 Amended	419	684	512	987	SEC29-T06S-R27E
AMC 298896	AZCO #430 Amended	419	686	512	989	SEC29-T06S-R27E
AMC 298897	AZCO #461 Amended	419	708	513	11	SEC28-T06S-R27E
AMC 298898	AZCO #462 Amended	419	710	513	13	SEC28-T06S-R27E
AMC 298899	AZCO #463 Amended	419	712	513	15	SEC28-T06S-R27E
AMC 298929	AZCO #190 Amended	419	818	512	847	SEC27-T06S-R27E
AMC 298930	AZCO #191 Amended	419	820	512	849	SEC27-T06S-R27E
AMC 298931	AZCO #192 Amended	419	822	512	851	SEC27-T06S-R27E
AMC 298932	AZCO #193 Amended	419	824	512	853	SEC27-T06S-R27E
AMC 298933	AZCO #194 Amended	419	826	512	855	SEC27-T06S-R27E
AMC 298934	AZCO #358 Amended	419	828	512	891	SEC24-T06S-R27E
AMC 298935	AZCO #360 Amended	419	830	512	895	SEC24-T06S-R27E
AMC 298936	AZCO #362 Amended	419	832	512	899	SEC24-T06S-R27E
AMC 305755	AZCO #441 Amended	426	703	512	991	SEC29-T06S-R27E
AMC 305756	AZCO #442 Amended	426	705	512	993	SEC29-T06S-R27E
AMC 305757	AZCO #443 Amended	426	707	512	995	SEC29-T06S-R27E
AMC 305758	AZCO #444 Amended	426	709	512	997	SEC21-T06S-R27E
AMC 305759	AZCO #445 Amended	426	711	512	999	SEC20-T06S-R27E
AMC 305760	AZCO #446 Amended	426	713	513	1	SEC20-T06S-R27E
AMC 305761	AZCO #447 Amended	426	715	513	03	SEC20-T06S-R27E
AMC 305762	AZCO #448 Amended	426	717	513	05	SEC20-T06S-R27E
AMC 305763	AZCO #449 Amended	426	719	513	07	SEC20-T06S-R27E
AMC 305764	AZCO #450 Amended	426	721	513	09	SEC20-T06S-R27E
AMC 321860	M1	448	441			SEC15-T06S-R27E
AMC 321861	M2	448	443			SEC15-T06S-R27E
AMC 321862	M3	448	445			SEC15-T06S-R27E
AMC 321863	M4	448	447			SEC15-T06S-R27E
AMC 321864	M5	448	449			SEC15-T06S-R27E
AMC 321865	M6	448	451			SEC15-T06S-R27E
AMC 321866	M7	448	453			SEC15-T06S-R27E
AMC 321867	M8	448	455			SEC15-T06S-R27E
AMC 321868	M9	448	457			SEC15-T06S-R27E
AMC 321869	M10	448	459			SEC15-T06S-R27E
AMC 321870	M11	448	461			SEC15-T06S-R27E
AMC 321871	M12	448	463			SEC15-T06S-R27E
AMC 321872	M13	448	465			SEC15-T06S-R27E
AMC 321873	M14	448	467			SEC15-T06S-R27E
AMC 321874	M15	448	469			SEC15-T06S-R27E
AMC 321875	M16	448	471			SEC15-T06S-R27E
AMC 321876	M17	448	473			SEC15-T06S-R27E
AMC 321877	M18	448	475			SEC15-T06S-R27E
AMC 321878	M37	448	477			SEC10-T06S-R27E
AMC 321879	M38	448	479			SEC10-T06S-R27E
AMC 321880	M39	448	481			SEC15-T06S-R27E
AMC 321881	M40	448	483			SEC15-T06S-R27E
AMC 321882	M41	448	485			SEC15-T06S-R27E
AMC 321883	M42	448	487			SEC15-T06S-R27E

RECEIVED  
 BLM  
 AND  
 DEC 15 11:30 AM '03  
 FEDERAL BUREAU OF INVESTIGATION  
 U.S. DEPARTMENT OF JUSTICE

EXHIBIT A

AMC 321884	M43	448	489	SEC15-T06S-R27E
AMC 321885	M44	448	491	SEC15-T06S-R27E
AMC 321886	M45	448	493	SEC15-T06S-R27E
AMC 321887	M46	448	495	SEC15-T06S-R27E
AMC 321888	M47	448	497	SEC15-T06S-R27E
AMC 321889	M48	448	499	SEC15-T06S-R27E
AMC 321890	M49	448	501	SEC15-T06S-R27E
AMC 321891	M50	448	503	SEC15-T06S-R27E
AMC 321892	M51	448	505	SEC15-T06S-R27E
AMC 321893	M52	448	507	SEC15-T06S-R27E
AMC 321894	M53	448	509	SEC15-T06S-R27E
AMC 321895	M54	448	511	SEC15-T06S-R27E
AMC 321896	M73	448	513	SEC10-T06S-R27E
AMC 321897	M74	448	515	SEC10-T06S-R27E
AMC 321898	M75	448	517	SEC10-T06S-R27E
AMC 321899	M76	448	519	SEC10-T06S-R27E
AMC 321900	M77	448	521	SEC10-T06S-R27E
AMC 321901	M78	448	523	SEC10-T06S-R27E
AMC 321902	M79	448	525	SEC10-T06S-R27E
AMC 321903	M80	448	527	SEC10-T06S-R27E
AMC 321904	M81	448	529	SEC10-T06S-R27E
AMC 321905	M82	448	531	SEC10-T06S-R27E
AMC 321906	M83	448	533	SEC10-T06S-R27E
AMC 321907	M84	448	535	SEC10-T06S-R27E
AMC 321908	M85	448	537	SEC10-T06S-R27E
AMC 321909	M86	448	539	SEC10-T06S-R27E
AMC 321910	M87	448	541	SEC11-T06S-R27E
AMC 321911	M88	448	543	SEC11-T06S-R27E
AMC 321912	M89	448	545	SEC11-T06S-R27E
AMC 321913	M90	448	547	SEC11-T06S-R27E
AMC 321914	M91	448	549	SEC11-T06S-R27E
AMC 321915	M92	448	551	SEC11-T06S-R27E
AMC 321916	M93	448	553	SEC11-T06S-R27E
AMC 321917	M94	448	555	SEC11-T06S-R27E
AMC 321918	M95	448	557	SEC11-T06S-R27E
AMC 321919	M96	448	559	SEC11-T06S-R27E
AMC 321920	M97	448	561	SEC11-T06S-R27E
AMC 321921	M98	448	563	SEC11-T06S-R27E
AMC 321922	M99	448	565	SEC11-T06S-R27E
AMC 321923	M100	448	567	SEC11-T06S-R27E
AMC 321924	M101	448	569	SEC11-T06S-R27E
AMC 321925	M102	448	571	SEC11-T06S-R27E
AMC 321926	M103	448	573	SEC11-T06S-R27E
AMC 321927	M104	448	575	SEC11-T06S-R27E
AMC 321928	M105	448	577	SEC10-T06S-R27E
AMC 321929	M106	448	579	SEC10-T06S-R27E
AMC 321930	M107	448	581	SEC10-T06S-R27E

RECEIVED  
MAY 2 2006  
MAY 2 2006  
MAY 2 2006

EXHIBIT A

AMC 321931	M108	448	583			SEC10-T06S-R27E
AMC 321932	M109	448	585			SEC10-T06S-R27E
AMC 321933	M110	448	587			SEC11-T06S-R27E
AMC 321934	M111	448	589			SEC11-T06S-R27E
AMC 321935	M112	448	591			SEC11-T06S-R27E
AMC 321936	M113	448	593			SEC11-T06S-R27E
AMC 321937	M114	448	595			SEC11-T06S-R27E
AMC 321938	M115	448	597			SEC11-T06S-R27E
AMC 321939	M116	448	599			SEC11-T06S-R27E
AMC 321940	M117	448	601			SEC11-T06S-R27E
AMC 321941	M118	448	603			SEC11-T06S-R27E
AMC 321942	M119	448	605			SEC10-T06S-R27E
AMC 321943	M120	448	607			SEC10-T06S-R27E
AMC 321944	M121	448	609			SEC11-T06S-R27E
AMC 321945	M122	448	611			SEC11-T06S-R27E
AMC 321946	M123	448	613			SEC11-T06S-R27E
AMC 321947	M124	448	615			SEC11-T06S-R27E
AMC 324229	M56	452	54			SEC11-T06S-R27E
AMC 324230	M58	452	56			SEC14-T06S-R27E
AMC 324231	M60	452	58			SEC11-T06S-R27E
AMC 324232	M62	452	60			SEC11-T06S-R27E
AMC 324233	M64	452	62			SEC11-T06S-R27E
AMC 324234	M66	452	64			SEC11-T06S-R27E
AMC 324235	M68	452	66			SEC11-T06S-R27E
AMC 324236	M70	452	68			SEC11-T06S-R27E
AMC 324237	M72	452	70			SEC11-T06S-R27E
AMC 324367	AZCO #465 Amended	449	937	513	17	SEC28-T06S-R27E
AMC 324368	AZCO #466 Amended	449	939	513	19	SEC28-T06S-R27E
AMC 324369	AZCO #467 Amended	449	941	513	21	SEC28-T06S-R27E
AMC 324370	AZCO #468 Amended	449	943	513	23	SEC28-T06S-R27E
AMC 324371	AZCO #469 Amended	449	945	513	25	SEC21-T06S-R27E
AMC 324892	MG 121	453	901			SEC30-T05S-R26E
AMC 324893	MG 122	453	903			SEC30-T05S-R26E
AMC 324894	MG 123	453	905			SEC30-T05S-R26E
AMC 324895	MG 124	453	907			SEC30-T05S-R26E
AMC 324896	MG 125	453	909			SEC30-T05S-R26E
AMC 324897	MG 126	453	911			SEC30-T05S-R26E
AMC 324898	MG 127	453	913			SEC30-T05S-R26E
AMC 324899	MG 128	453	915			SEC30-T05S-R26E
AMC 324900	MG 129	453	917			SEC30-T05S-R26E
AMC 324901	MG 130	453	919			SEC30-T05S-R26E
AMC 324902	MG 179	453	933			SEC25-T05S-R25E
AMC 324903	MG 180	453	935			SEC25-T05S-R25E
AMC 324904	MG 181	453	937			SEC25-T05S-R25E
AMC 324905	MG 182	453	939			SEC25-T05S-R25E
AMC 324906	MG 183	453	941			SEC25-T05S-R25E
AMC 324907	MG 184	453	943			SEC25-T05S-R25E

RECEIVED  
 BLM AT STATE OFFICE  
 2011 DEC 11 AM 11:33  
 FEDERAL BUREAU OF LAND MANAGEMENT

EXHIBIT A

AMC 324908	MG 185	453	945	SEC25-T05S-R25E
AMC 324909	MG 186	453	947	SEC25-T05S-R25E
AMC 324910	MG 187	453	949	SEC25-T05S-R25E
AMC 324911	MG 188	453	951	SEC25-T05S-R25E
AMC 324912	MG 189	453	953	SEC25-T05S-R25E
AMC 324913	MG 190	453	955	SEC25-T05S-R25E
AMC 324914	MG 191	453	957	SEC25-T05S-R25E
AMC 324915	MG 192	453	959	SEC25-T05S-R25E
AMC 324916	MG 193	453	961	SEC25-T05S-R25E
AMC 324917	MG 194	453	963	SEC25-T05S-R25E
AMC 324918	MG 195	453	965	SEC25-T05S-R25E
AMC 324919	MG 196	453	967	SEC25-T05S-R25E
AMC 324920	MG 223	453	969	SEC25-T05S-R25E
AMC 324921	MG 224	453	971	SEC25-T05S-R25E
AMC 324922	MG 225	453	973	SEC25-T05S-R25E
AMC 324923	MG 226	453	975	SEC25-T05S-R25E
AMC 324924	MG 227	453	977	SEC25-T05S-R25E
AMC 324925	MG 228	453	979	SEC25-T05S-R25E
AMC 324926	MG 229	453	981	SEC25-T05S-R25E
AMC 324927	MG 230	453	983	SEC25-T05S-R25E
AMC 324928	MG 231	453	985	SEC25-T05S-R25E
AMC 324929	MG 232	453	987	SEC25-T05S-R25E
AMC 324930	MG 233	453	989	SEC25-T05S-R25E
AMC 324931	MG 234	453	991	SEC25-T05S-R25E
AMC 324932	MG 235	453	993	SEC25-T05S-R25E
AMC 324933	MG 236	453	995	SEC25-T05S-R25E
AMC 324934	MG 237	453	997	SEC25-T05S-R25E
AMC 324935	MG 238	453	999	SEC25-T05S-R25E
AMC 324936	MG 239	454	1	SEC25-T05S-R25E
AMC 324937	MG 240	454	2A	SEC25-T05S-R25E
AMC 326065	SOB 1	458	703	SEC27-T06S-R27E
AMC 326066	SOB 2	458	704	SEC27-T06S-R27E
AMC 326067	SOB 3	458	705	SEC27-T06S-R27E
AMC 326068	SOB 4	458	706	SEC27-T06S-R27E
AMC 326069	SOB 5	458	707	SEC27-T06S-R27E
AMC 326070	SOB 6	458	708	SEC27-T06S-R27E
AMC 326071	SOB 7	458	709	SEC27-T06S-R27E
AMC 326072	SOB 8	458	710	SEC27-T06S-R27E
AMC 326073	SOB 9	458	711	SEC27-T06S-R27E
AMC 326074	SOB 10	458	712	SEC27-T06S-R27E
AMC 326075	SOB 11	458	713	SEC27-T06S-R27E
AMC 326076	SOB 12	458	714	SEC27-T06S-R27E
AMC 326077	SOB 13	458	715	SEC29-T06S-R27E
AMC 326078	SOB 14	458	716	SEC29-T06S-R27E
AMC 326079	SOB 15	458	717	SEC29-T06S-R27E
AMC 326080	SOB 16	458	718	SEC29-T06S-R27E
AMC 326081	SOB 17	458	719	SEC29-T06S-R27E

RECEIVED  
 2015  
 APR 13 11:30 AM  
 SEC 27-T06S-R27E



EXHIBIT A

AMC 326082	SOB 18	458	720	SEC29-T06S-R27E
AMC 326083	SOB 19	458	721	SEC20-T06S-R27E
AMC 326084	SOB 20	458	722	SEC20-T06S-R27E
AMC 326085	SOB 21	458	723	SEC20-T06S-R27E
AMC 326086	SOB 22	458	724	SEC20-T06S-R27E
AMC 326087	SOB 23	458	725	SEC29-T06S-R27E
AMC 326088	SOB 24	458	726	SEC29-T06S-R27E
AMC 326089	SOB 25	458	727	SEC29-T06S-R27E
AMC 326090	SOB 26	458	728	SEC29-T06S-R27E
AMC 326091	SOB 27	458	729	SEC29-T06S-R27E
AMC 326092	SOB 28	458	730	SEC29-T06S-R27E
AMC 326093	SOB 29	458	731	SEC29-T06S-R27E
AMC 326094	SOB 30	458	732	SEC29-T06S-R27E
AMC 326095	SOB 31	458	733	SEC29-T06S-R27E
AMC 326096	SOB 32	458	734	SEC29-T06S-R27E
AMC 326097	SOB 33	458	735	SEC29-T06S-R27E
AMC 326098	SOB 34	458	736	SEC29-T06S-R27E
AMC 326099	SOB 35	458	737	SEC29-T06S-R27E
AMC 326100	SOB 36	458	738	SEC29-T06S-R27E
AMC 326101	SOB 37	458	739	SEC29-T06S-R27E
AMC 326102	SOB 38	458	740	SEC29-T06S-R27E
AMC 326103	SOB 39	458	741	SEC29-T06S-R27E
AMC 326104	SOB 40	458	742	SEC29-T06S-R27E
AMC 326105	SOB 41	458	743	SEC29-T06S-R27E
AMC 326106	SOB 42	458	744	SEC29-T06S-R27E
AMC 326107	SOB 43	458	745	SEC29-T06S-R27E
AMC 326108	SOB 44	458	746	SEC29-T06S-R27E
AMC 326109	SOB 45	458	747	SEC29-T06S-R27E
AMC 326110	SOB 46	458	748	SEC29-T06S-R27E
AMC 326111	SOB 47	458	749	SEC21-T06S-R27E
AMC 326112	SOB 48	458	750	SEC21-T06S-R27E
AMC 326113	SOB 49	458	751	SEC21-T06S-R27E
AMC 326114	SOB 50	458	752	SEC21-T06S-R27E
AMC 326115	SOB 51	458	753	SEC28-T06S-R27E
AMC 326116	SOB 52	458	754	SEC28-T06S-R27E
AMC 326117	SOB 53	458	755	SEC28-T06S-R27E
AMC 326118	SOB 54	458	756	SEC28-T06S-R27E
AMC 326119	SOB 55	458	757	SEC28-T06S-R27E
AMC 326120	SOB 56	458	758	SEC28-T06S-R27E
AMC 326121	SOB 57	458	759	SEC28-T06S-R27E
AMC 326122	SOB 58	458	760	SEC28-T06S-R27E
AMC 326123	SOB 59	458	761	SEC28-T06S-R27E
AMC 326124	SOB 60	458	762	SEC28-T06S-R27E
AMC 326125	SOB 61	458	763	SEC28-T06S-R27E
AMC 326126	SOB 62	458	764	SEC28-T06S-R27E
AMC 326127	SOB 63	458	765	SEC28-T06S-R27E
AMC 326128	SOB 64	458	766	SEC28-T06S-R27E

RECEIVED  
 2011 SEP 12 AM 11:24  
 FEDERAL BUREAU OF INVESTIGATION  
 U.S. DEPARTMENT OF JUSTICE

EXHIBIT A

AMC 326129	SOB 65	458	767	SEC28-T06S-R27E
AMC 326130	SOB 66	458	768	SEC28-T06S-R27E
AMC 326131	SOB 67	458	769	SEC28-T06S-R27E
AMC 326132	SOB 68	458	770	SEC28-T06S-R27E
AMC 326133	SOB 69	458	771	SEC28-T06S-R27E
AMC 326134	SOB 70	458	772	SEC28-T06S-R27E
AMC 326135	SOB 71	458	773	SEC28-T06S-R27E
AMC 326136	SOB 72	458	774	SEC28-T06S-R27E
AMC 326137	SOB 73	458	775	SEC28-T06S-R27E
AMC 326138	SOB 74	458	776	SEC28-T06S-R27E
AMC 326139	SOB 75	458	777	SEC28-T06S-R27E
AMC 326140	SOB 76	458	778	SEC28-T06S-R27E
AMC 326141	SOB 77	458	779	SEC21-T06S-R27E
AMC 326142	SOB 78	458	780	SEC21-T06S-R27E
AMC 326143	SOB 79	458	781	SEC28-T06S-R27E
AMC 326144	SOB 80	458	782	SEC28-T06S-R27E
AMC 326145	SOB 81	458	783	SEC28-T06S-R27E
AMC 326146	SOB 82	458	784	SEC28-T06S-R27E
AMC 326147	SOB 83	458	785	SEC28-T06S-R27E
AMC 326148	SOB 84	458	786	SEC28-T06S-R27E
AMC 326149	SOB 85	458	787	SEC28-T06S-R27E
AMC 326150	SOB 86	458	788	SEC28-T06S-R27E
AMC 326151	SOB 87	458	789	SEC28-T06S-R27E
AMC 326152	SOB 88	458	790	SEC28-T06S-R27E
AMC 326153	SOB 89	458	791	SEC28-T06S-R27E
AMC 326154	SOB 90	458	792	SEC28-T06S-R27E
AMC 326155	SOB 91	458	793	SEC28-T06S-R27E
AMC 326156	SOB 92	458	794	SEC28-T06S-R27E
AMC 326157	SOB 93	458	795	SEC28-T06S-R27E
AMC 326158	SOB 94	458	796	SEC28-T06S-R27E
AMC 326159	SOB 95	458	797	SEC28-T06S-R27E
AMC 326160	SOB 96	458	798	SEC28-T06S-R27E
AMC 326161	SOB 97	458	799	SEC28-T06S-R27E
AMC 326162	SOB 98	458	800	SEC28-T06S-R27E
AMC 326163	SOB 99	458	801	SEC28-T06S-R27E
AMC 326164	SOB 100	458	802	SEC28-T06S-R27E
AMC 326165	SOB 101	458	803	SEC28-T06S-R27E
AMC 326166	SOB 102	458	804	SEC28-T06S-R27E
AMC 326167	SOB 103	458	805	SEC28-T06S-R27E
AMC 326168	SOB 104	458	806	SEC28-T06S-R27E
AMC 326169	SOB 105	458	807	SEC28-T06S-R27E
AMC 326170	SOB 106	458	808	SEC28-T06S-R27E
AMC 326171	SOB 107	458	809	SEC28-T06S-R27E
AMC 326172	SOB 108	458	810	SEC28-T06S-R27E
AMC 326173	SOB 109	458	811	SEC28-T06S-R27E
AMC 326174	SOB 110	458	812	SEC28-T06S-R27E
AMC 326175	SOB 111	458	813	SEC33-T06S-R27E

RECEIVED  
 DIVISION OF  
 INVESTIGATION  
 JAN 11 1962  
 FBI - NEW YORK

EXHIBIT A

AMC 326176	SOB 112	458	814	SEC33-T06S-R27E
AMC 326177	SOB 113	458	815	SEC33-T06S-R27E
AMC 326178	SOB 114	458	816	SEC33-T06S-R27E
AMC 326179	SOB 115	458	817	SEC28-T06S-R27E
AMC 326180	SOB 116	458	818	SEC28-T06S-R27E
AMC 326181	SOB 117	458	819	SEC28-T06S-R27E
AMC 326182	SOB 118	458	820	SEC28-T06S-R27E
AMC 326183	SOB 119	458	821	SEC28-T06S-R27E
AMC 326184	SOB 120	458	822	SEC28-T06S-R27E
AMC 326185	SOB 121	458	823	SEC28-T06S-R27E
AMC 326186	SOB 122	458	824	SEC28-T06S-R27E
AMC 326187	SOB 123	458	825	SEC28-T06S-R27E
AMC 326188	SOB 124	458	826	SEC28-T06S-R27E
AMC 326189	SOB 125	458	827	SEC28-T06S-R27E
AMC 326190	SOB 126	458	828	SEC28-T06S-R27E
AMC 326191	SOB 127	458	829	SEC28-T06S-R27E
AMC 326192	SOB 128	458	830	SEC28-T06S-R27E
AMC 326193	SOB 129	458	831	SEC28-T06S-R27E
AMC 326194	SOB 130	458	832	SEC28-T06S-R27E
AMC 326195	SOB 131	458	833	SEC28-T06S-R27E
AMC 326196	SOB 132	458	834	SEC28-T06S-R27E
AMC 326197	SOB 133	458	835	SEC28-T06S-R27E
AMC 326198	SOB 134	458	836	SEC28-T06S-R27E
AMC 326199	SOB 135	458	837	SEC28-T06S-R27E
AMC 326200	SOB 136	458	838	SEC28-T06S-R27E
AMC 326201	SOB 137	458	839	SEC28-T06S-R27E
AMC 326202	SOB 138	458	840	SEC28-T06S-R27E
AMC 326203	SOB 139	458	841	SEC28-T06S-R27E
AMC 326204	SOB 140	458	842	SEC28-T06S-R27E
AMC 326205	SOB 141	458	843	SEC28-T06S-R27E
AMC 326206	SOB 142	458	844	SEC28-T06S-R27E
AMC 326207	SOB 143	458	845	SEC28-T06S-R27E
AMC 326208	SOB 144	458	846	SEC28-T06S-R27E
AMC 326209	SOB 145	458	847	SEC28-T06S-R27E
AMC 326210	SOB 146	458	848	SEC33-T06S-R27E
AMC 326211	SOB 147	458	849	SEC33-T06S-R27E
AMC 326212	SOB 148	458	850	SEC33-T06S-R27E
AMC 326213	SOB 149	458	851	SEC33-T06S-R27E
AMC 326214	SOB 150	458	852	SEC33-T06S-R27E
AMC 326215	SOB 151	458	853	SEC33-T06S-R27E
AMC 326216	SOB 152	458	854	SEC28-T06S-R27E
AMC 326217	SOB 153	458	855	SEC28-T06S-R27E
AMC 326218	SOB 154	458	856	SEC28-T06S-R27E
AMC 326219	SOB 155	458	857	SEC28-T06S-R27E
AMC 326220	SOB 156	458	858	SEC28-T06S-R27E
AMC 326221	SOB 157	458	859	SEC28-T06S-R27E
AMC 326222	SOB 158	458	860	SEC28-T06S-R27E

RECEIVED  
 2010  
 SEC33-T06S-R27E

EXHIBIT A

AMC 326223	SOB 159	458	861	SEC28-T06S-R27E
AMC 326224	SOB 160	458	862	SEC28-T06S-R27E
AMC 326225	SOB 161	458	863	SEC28-T06S-R27E
AMC 326226	SOB 162	458	864	SEC28-T06S-R27E
AMC 326227	SOB 163	458	865	SEC28-T06S-R27E
AMC 326228	SOB 164	458	866	SEC28-T06S-R27E
AMC 326229	SOB 165	458	867	SEC28-T06S-R27E
AMC 326230	SOB 166	458	868	SEC28-T06S-R27E
AMC 326231	SOB 167	458	869	SEC28-T06S-R27E
AMC 326232	SOB 168	458	870	SEC28-T06S-R27E
AMC 326233	SOB 169	458	871	SEC28-T06S-R27E
AMC 326234	SOB 170	458	872	SEC28-T06S-R27E
AMC 326235	SOB 171	458	873	SEC28-T06S-R27E
AMC 326236	SOB 172	458	874	SEC28-T06S-R27E
AMC 326237	SOB 173	458	875	SEC28-T06S-R27E
AMC 326238	SOB 174	458	876	SEC28-T06S-R27E
AMC 326239	SOB 175	458	877	SEC28-T06S-R27E
AMC 326240	SOB 176	458	878	SEC28-T06S-R27E
AMC 326241	SOB 177	458	879	SEC28-T06S-R27E
AMC 326242	SOB 178	458	880	SEC28-T06S-R27E
AMC 326243	SOB 179	458	881	SEC28-T06S-R27E
AMC 326244	SOB 180	458	882	SEC33-T06S-R27E
AMC 326245	SOB 181	458	883	SEC33-T06S-R27E
AMC 326246	SOB 182	458	884	SEC33-T06S-R27E
AMC 326247	SOB 183	458	885	SEC33-T06S-R27E
AMC 326248	SOB 184	458	886	SEC33-T06S-R27E
AMC 326249	SOB 185	458	887	SEC33-T06S-R27E
AMC 326250	SOB 186	458	888	SEC33-T06S-R27E
AMC 326251	SOB 187	458	889	SEC33-T06S-R27E
AMC 326252	SOB 188	458	890	SEC27-T06S-R27E
AMC 326253	SOB 189	458	891	SEC27-T06S-R27E
AMC 326254	SOB 190	458	892	SEC27-T06S-R27E
AMC 326255	SOB 191	458	893	SEC27-T06S-R27E
AMC 326256	SOB 192	458	894	SEC27-T06S-R27E
AMC 326257	SOB 193	458	895	SEC27-T06S-R27E
AMC 326258	SOB 194	458	896	SEC27-T06S-R27E
AMC 326259	SOB 195	458	897	SEC27-T06S-R27E
AMC 326260	SOB 196	458	898	SEC27-T06S-R27E
AMC 326261	SOB 197	458	899	SEC27-T06S-R27E
AMC 326262	SOB 198	458	900	SEC27-T06S-R27E
AMC 326263	SOB 199	458	901	SEC27-T06S-R27E
AMC 326264	SOB 200	458	902	SEC27-T06S-R27E
AMC 326265	SOB 201	458	903	SEC27-T06S-R27E
AMC 326266	SOB 202	458	904	SEC27-T06S-R27E
AMC 326267	SOB 203	458	905	SEC27-T06S-R27E
AMC 326268	SOB 204	458	906	SEC27-T06S-R27E
AMC 326269	SOB 205	458	907	SEC27-T06S-R27E

PHOENIX, ARIZONA  
 OCT 12 2011  
 12:53 PM

EXHIBIT A

AMC 326270	SOB 206	458	908	SEC27-T06S-R27E
AMC 326271	SOB 207	458	909	SEC27-T06S-R27E
AMC 326272	SOB 208	458	910	SEC27-T06S-R27E
AMC 326273	SOB 209	458	911	SEC27-T06S-R27E
AMC 326274	SOB 210	458	912	SEC27-T06S-R27E
AMC 326275	SOB 211	458	913	SEC27-T06S-R27E
AMC 326276	SOB 212	458	914	SEC27-T06S-R27E
AMC 326277	SOB 213	458	915	SEC34-T06S-R27E
AMC 326278	SOB 214	458	916	SEC34-T06S-R27E
AMC 326279	SOB 215	458	917	SEC26-T06S-R27E
AMC 326280	SOB 216	458	918	SEC26-T06S-R27E
AMC 326281	SOB 217	458	919	SEC26-T06S-R27E
AMC 326282	SOB 218	458	920	SEC26-T06S-R27E
AMC 326843	M19	463	593	SEC14-T06S-R27E
AMC 326844	M20	463	595	SEC14-T06S-R27E
AMC 326845	M21	463	597	SEC14-T06S-R27E
AMC 326846	M22	463	599	SEC14-T06S-R27E
AMC 326847	M23	463	601	SEC14-T06S-R27E
AMC 326848	M24	463	603	SEC14-T06S-R27E
AMC 326849	M25	463	605	SEC14-T06S-R27E
AMC 326850	M26	463	607	SEC14-T06S-R27E
AMC 326851	M27	463	609	SEC14-T06S-R27E
AMC 326852	M28	463	611	SEC14-T06S-R27E
AMC 326853	M29	463	613	SEC14-T06S-R27E
AMC 326854	M30	463	615	SEC14-T06S-R27E
AMC 326855	M31	463	617	SEC14-T06S-R27E
AMC 326856	M55	463	629	SEC14-T06S-R27E
AMC 326857	M32	463	619	SEC14-T06S-R27E
AMC 326858	M33	463	621	SEC14-T06S-R27E
AMC 326859	M34	463	623	SEC14-T06S-R27E
AMC 326860	M35	463	625	SEC14-T06S-R27E
AMC 326861	M36	463	627	SEC14-T06S-R27E
AMC 326862	M57	463	631	SEC14-T06S-R27E
AMC 326863	M59	463	633	SEC14-T06S-R27E
AMC 326864	M61	463	635	SEC14-T06S-R27E
AMC 326865	M63	463	637	SEC14-T06S-R27E
AMC 326866	M65	463	639	SEC14-T06S-R27E
AMC 326867	M67	463	641	SEC14-T06S-R27E
AMC 326868	M69	463	643	SEC14-T06S-R27E
AMC 326869	M71	463	645	SEC14-T06S-R27E
AMC 326870	M145	463	647	SEC22-T06S-R27E
AMC 326871	M146	463	649	SEC22-T06S-R27E
AMC 326872	M147	463	651	SEC22-T06S-R27E
AMC 326873	M148	463	653	SEC22-T06S-R27E
AMC 326874	M149	463	655	SEC22-T06S-R27E
AMC 326875	M150	463	657	SEC22-T06S-R27E
AMC 326876	M151	463	659	SEC22-T06S-R27E

RECEIVED

EXHIBIT A

AMC 326877	M152	463	661	SEC22-T06S-R27E
AMC 326878	M153	463	663	SEC22-T06S-R27E
AMC 326879	M154	463	665	SEC22-T06S-R27E
AMC 326880	M155	463	667	SEC22-T06S-R27E
AMC 326881	M156	463	669	SEC22-T06S-R27E
AMC 326882	M157	463	671	SEC22-T06S-R27E
AMC 326883	M158	463	673	SEC22-T06S-R27E
AMC 326884	M159	463	675	SEC22-T06S-R27E
AMC 326885	M160	463	677	SEC22-T06S-R27E
AMC 326886	M161	463	679	SEC22-T06S-R27E
AMC 326887	M162	463	681	SEC22-T06S-R27E
AMC 326888	M163	463	683	SEC23-T06S-R27E
AMC 326889	M164	463	685	SEC23-T06S-R27E
AMC 326890	M165	463	687	SEC23-T06S-R27E
AMC 326891	M166	463	689	SEC23-T06S-R27E
AMC 326892	M167	463	691	SEC23-T06S-R27E
AMC 326893	M168	463	693	SEC23-T06S-R27E
AMC 326894	M169	463	695	SEC23-T06S-R27E
AMC 326895	M170	463	697	SEC23-T06S-R27E
AMC 326896	M171	463	699	SEC23-T06S-R27E
AMC 326897	M172	463	701	SEC23-T06S-R27E
AMC 326898	M173	463	703	SEC23-T06S-R27E
AMC 326899	M174	463	705	SEC23-T06S-R27E
AMC 326900	M175	463	707	SEC23-T06S-R27E
AMC 326901	M176	463	709	SEC23-T06S-R27E
AMC 326902	M177	463	711	SEC23-T06S-R27E
AMC 326903	M178	463	713	SEC23-T06S-R27E
AMC 326904	M188	463	715	SEC22-T06S-R27E
AMC 326905	M189	463	717	SEC22-T06S-R27E
AMC 326906	M190	463	719	SEC22-T06S-R27E
AMC 326907	M191	463	721	SEC22-T06S-R27E
AMC 326908	M192	463	723	SEC22-T06S-R27E
AMC 326909	M193	463	725	SEC22-T06S-R27E
AMC 326910	M194	463	727	SEC22-T06S-R27E
AMC 326911	M195	463	729	SEC22-T06S-R27E
AMC 326912	M196	463	731	SEC22-T06S-R27E
AMC 326913	M197	463	733	SEC23-T06S-R27E
AMC 326914	M199	463	735	SEC22-T06S-R27E
AMC 326915	M200	463	737	SEC22-T06S-R27E
AMC 326916	M201	463	739	SEC22-T06S-R27E
AMC 326917	M202	463	741	SEC22-T06S-R27E
AMC 326918	M203	463	743	SEC22-T06S-R27E
AMC 326919	M204	463	745	SEC22-T06S-R27E
AMC 326920	M205	463	747	SEC22-T06S-R27E
AMC 326921	M206	463	749	SEC22-T06S-R27E
AMC 329068	MG 5	471	483	SEC20-T05S-R26E
AMC 329077	MG 24	471	501	SEC20-T05S-R26E

RECEIVED  
 2022-10-11  
 11:11 AM



EXHIBIT A

AMC 329078	MG 25	471	503			SEC20-T05S-R26E
AMC 329087	MG 83	471	521			SEC19-T05S-R26E
AMC 329088	MG 84	471	523			SEC19-T05S-R26E
AMC 329089	MG 131	471	525			SEC19-T05S-R26E
AMC 329090	MG 133	471	527			SEC19-T05S-R26E
AMC 329091	MG 135	471	529			SEC19-T05S-R26E
AMC 329092	MG 137	471	531			SEC19-T05S-R26E
AMC 329093	MG 139	471	533			SEC19-T05S-R26E
AMC 329113	Joy 179	471	573			SEC10-T06S-R26E
AMC 329115	Joy 181	471	577			SEC10-T06S-R26E
AMC 329123	Joy 189	471	593			SEC10-T06S-R26E
AMC 329124	Joy 190	471	595			SEC11-T06S-R26E
AMC 329125	Joy 191	471	597			SEC11-T06S-R26E
AMC 329126	Joy 192	471	599			SEC11-T06S-R26E
AMC 329127	Joy 193	471	601			SEC11-T06S-R26E
AMC 329128	Joy 194	471	603			SEC11-T06S-R26E
AMC 329129	Joy 195	471	605			SEC11-T06S-R26E
AMC 329130	Joy 196	471	607			SEC11-T06S-R26E
AMC 329144	Joy 210A	471	635	481	919	SEC02-T06S-R26E
AMC 329145	Joy 212A	471	637	481	923	SEC02-T06S-R26E
AMC 330969	Joy 214	478	215			SEC02-T06S-R26E
AMC 330971	Joy 216	478	219			SEC02-T06S-R26E
AMC 330973	Joy 218	478	223			SEC02-T06S-R26E
AMC 331745	Joy 303	483	801			SEC14-T06S-R26E
AMC 331747	Joy 305	483	805			SEC14-T06S-R26E
AMC 331749	Joy 307	483	809			SEC14-T06S-R26E
AMC 331751	Joy 309	483	813			SEC14-T06S-R26E
AMC 331752	Joy 310	483	815			SEC14-T06S-R26E
AMC 331753	Joy 312	483	817			SEC14-T06S-R26E
AMC 333390	M207	488	141			SEC21-T06S-R27E
AMC 333391	M208	488	143			SEC21-T06S-R27E
AMC 333392	M209	488	145			SEC21-T06S-R27E
AMC 333393	M210	488	147			SEC21-T06S-R27E
AMC 333394	M211	488	149			SEC21-T06S-R27E
AMC 333395	M212	488	151			SEC21-T06S-R27E
AMC 333396	M213	488	153			SEC21-T06S-R27E
AMC 333397	M214	488	155			SEC21-T06S-R27E
AMC 333398	M215	488	157			SEC21-T06S-R27E
AMC 333399	M216	488	159			SEC21-T06S-R27E
AMC 333400	M217	488	161			SEC21-T06S-R27E
AMC 333401	M218	488	163			SEC21-T06S-R27E
AMC 333402	M219	488	165			SEC21-T06S-R27E
AMC 333403	M220	488	167			SEC21-T06S-R27E
AMC 333404	M221	488	169			SEC21-T06S-R27E
AMC 333405	M222	488	171			SEC21-T06S-R27E
AMC 333406	M223	488	173			SEC21-T06S-R27E
AMC 333407	M224	488	175			SEC21-T06S-R27E

RECEIVED  
 ARK  
 DIVISION  
 11/16/2011

EXHIBIT A

AMC 333408	M225	488	177	SEC21-T06S-R27E
AMC 333409	M226	488	179	SEC21-T06S-R27E
AMC 333410	M227	488	181	SEC21-T06S-R27E
AMC 333411	M228	488	183	SEC21-T06S-R27E
AMC 333412	M229	488	185	SEC21-T06S-R27E
AMC 333413	M230	488	187	SEC21-T06S-R27E
AMC 333414	M231	488	189	SEC21-T06S-R27E
AMC 333415	M232	488	191	SEC21-T06S-R27E
AMC 333416	M233	488	193	SEC21-T06S-R27E
AMC 333417	M234	488	195	SEC21-T06S-R27E
AMC 333418	M235	488	197	SEC21-T06S-R27E
AMC 333419	M236	488	199	SEC16-T06S-R27E
AMC 333420	M237	488	201	SEC16-T06S-R27E
AMC 333421	M238	488	203	SEC16-T06S-R27E
AMC 334772	CHE 1	492	843	SEC23-T05S-R25E
AMC 334773	CHE 2	492	845	SEC23-T05S-R25E
AMC 334774	CHE 3	492	847	SEC23-T05S-R25E
AMC 334775	CHE 4	492	849	SEC23-T05S-R25E
AMC 334776	CHE 5	492	851	SEC23-T05S-R25E
AMC 334777	CHE 6	492	853	SEC23-T05S-R25E
AMC 334778	CHE 7	492	855	SEC23-T05S-R25E
AMC 334779	CHE 8	492	857	SEC23-T05S-R25E
AMC 334780	CHE 9	492	859	SEC23-T05S-R25E
AMC 334781	CHE 10	492	861	SEC23-T05S-R25E
AMC 334782	CHE 11	492	863	SEC26-T05S-R25E
AMC 334783	CHE 12	492	865	SEC26-T05S-R25E
AMC 334784	CHE 13	492	867	SEC26-T05S-R25E
AMC 334785	CHE 14	492	869	SEC26-T05S-R25E
AMC 334786	CHE 15	492	871	SEC26-T05S-R25E
AMC 334787	CHE 16	492	873	SEC26-T05S-R25E
AMC 334788	CHE 17	492	875	SEC26-T05S-R25E
AMC 334789	CHE 18	492	877	SEC26-T05S-R25E
AMC 334790	CHE 19	492	879	SEC26-T05S-R25E
AMC 334791	CHE 20	492	881	SEC26-T05S-R25E
AMC 334792	CHE 21	492	883	SEC26-T05S-R25E
AMC 334793	CHE 22	492	885	SEC26-T05S-R25E
AMC 334794	CHE 23	492	887	SEC26-T05S-R25E
AMC 334795	CHE 24	492	889	SEC26-T05S-R25E
AMC 334796	CHE 25	492	891	SEC26-T05S-R25E
AMC 334797	CHE 26	492	893	SEC26-T05S-R25E
AMC 334798	CHE 27	492	895	SEC26-T05S-R25E
AMC 334799	CHE 28	492	897	SEC26-T05S-R25E
AMC 334800	CHE 29	492	899	SEC23-T05S-R25E
AMC 334801	CHE 30	492	901	SEC23-T05S-R25E
AMC 334802	CHE 31	492	903	SEC23-T05S-R25E
AMC 334803	CHE 32	492	905	SEC23-T05S-R25E
AMC 334804	CHE 33	492	907	SEC23-T05S-R25E

RECEIVED  
 2011 DEC 15 10:05 AM  
 FEDERAL BUREAU OF INVESTIGATION  
 U.S. DEPARTMENT OF JUSTICE

EXHIBIT A

AMC 334805	CHE 34	492	909			SEC23-T05S-R25E
AMC 334806	CHE 35	492	911			SEC23-T05S-R25E
AMC 334807	CHE 36	492	913			SEC23-T05S-R25E
AMC 334808	CHE 37	492	915			SEC23-T05S-R25E
AMC 334809	CHE 38	492	917			SEC23-T05S-R25E
AMC 334810	CHE 39	492	919			SEC26-T05S-R25E
AMC 334811	CHE 40	492	921			SEC26-T05S-R25E
AMC 334812	CHE 41	492	923			SEC26-T05S-R25E
AMC 334813	CHE 42	492	925			SEC26-T05S-R25E
AMC 334814	CHE 43	492	927			SEC26-T05S-R25E
AMC 334815	CHE 44	492	929			SEC26-T05S-R25E
AMC 334816	CHE 45	492	931			SEC26-T05S-R25E
AMC 334817	CHE 46	492	933			SEC26-T05S-R25E
AMC 334818	CHE 47	492	935			SEC26-T05S-R25E
AMC 334819	CHE 48	492	937			SEC26-T05S-R25E
AMC 334820	CHE 49	492	939			SEC26-T05S-R25E
AMC 334821	CHE 50	492	941			SEC26-T05S-R25E
AMC 334822	CHE 51	492	943			SEC26-T05S-R25E
AMC 334823	CHE 52	492	945			SEC26-T05S-R25E
AMC 334824	CHE 53	492	947			SEC26-T05S-R25E
AMC 334825	CHE 54	492	949			SEC26-T05S-R25E
AMC 334826	CHE 55	492	951			SEC26-T05S-R25E
AMC 334827	CHE 56	492	953			SEC26-T05S-R25E
AMC 340515	BH 21	510	117			SEC24-T05S-R26E
AMC 340539	Cliff 1R	510	1			SEC22-T05S-R26E
AMC 340540	Cliff 2R	510	3			SEC22-T05S-R26E
AMC 340541	Cliff 3R	510	5			SEC22-T05S-R26E
AMC 340542	Cliff 4R	510	7			SEC22-T05S-R26E
AMC 340543	Cliff 6R	510	9			SEC22-T05S-R26E
AMC 340544	Cliff 8R	510	11			SEC22-T05S-R26E
AMC 340545	Cliff 23R	510	13			SEC26-T05S-R26E
AMC 340546	Cliff 24R	510	15			SEC26-T05S-R26E
AMC 340547	Cliff 25R	510	17			SEC23-T05S-R26E
AMC 340548	Cliff 26R	510	19			SEC23-T05S-R26E
AMC 340549	Cliff 27R	510	21			SEC23-T05S-R26E
AMC 340550	Cliff 28R	510	23			SEC23-T05S-R26E
AMC 340551	Cliff 29R	510	25			SEC23-T05S-R26E
AMC 340552	Cliff 30R	510	27			SEC23-T05S-R26E
AMC 340553	Cliff 31R	510	29			SEC23-T05S-R26E
AMC 340554	Cliff 32R	510	31			SEC23-T05S-R26E
AMC 340558	Cliff 41R Amended	510	39	532	479	SEC23-T05S-R26E
AMC 340559	Cliff 42R Amended	510	41	532	751	SEC23-T05S-R26E
AMC 340560	Cliff 43R Amended	510	43	532	753	SEC23-T05S-R26E
AMC 340561	Cliff 44R Amended	510	45	532	755	SEC23-T05S-R26E
AMC 340562	Cliff 45	510	47			SEC23-T05S-R26E
AMC 340563	Cliff 46	510	49			SEC23-T05S-R26E
AMC 340564	Cliff 59	510	51			SEC23-T05S-R26E

PHOENIX, ARIZONA  
 DEPARTMENT OF ENVIRONMENTAL QUALITY  
 DIVISION OF WATER  
 1000 N. CENTRAL AVENUE, SUITE 1000  
 PHOENIX, ARIZONA 85004

EXHIBIT A

AMC 340565	Cliff 60	510	53			SEC23-T05S-R26E
AMC 340566	Cliff 61	510	55			SEC23-T05S-R26E
AMC 340567	Cliff 62	510	57			SEC23-T05S-R26E
AMC 340568	Cliff 63	510	59			SEC23-T05S-R26E
AMC 340569	Cliff 64	510	61			SEC14-T05S-R26E
AMC 340570	Cliff 65	510	63			SEC14-T05S-R26E
AMC 340956	SG 1	513	27			SEC20-T06S-R27E
AMC 340957	SG 2	513	29			SEC28-T06S-R27E
AMC 340958	SG 3	513	31			SEC29-T06S-R27E
AMC 340959	SG 4	513	33			SEC29-T06S-R27E
AMC 340960	SG 5	513	35			SEC29-T06S-R27E
AMC 340961	SG 6	513	37			SEC33-T06S-R27E
AMC 340962	SG 7	513	39			SEC33-T06S-R27E
AMC 340963	SG 8	513	41			SEC33-T06S-R27E
AMC 340964	SG 9	513	43			SEC04-T07S-R27E
AMC 340965	SG 10	513	45			SEC04-T07S-R27E
AMC 340966	SG 11	513	47			SEC04-T07S-R27E
AMC 340967	SG 12 Amended	513	49	525	947	SEC04-T07S-R27E
AMC 340968	SG 13	513	51			SEC04-T07S-R27E
AMC 340969	SG 14	513	53			SEC04-T07S-R27E
AMC 340970	SG 15	513	55			SEC33-T06S-R27E
AMC 340971	SG 16	513	57			SEC33-T06S-R27E
AMC 340972	SG 17	513	59			SEC33-T06S-R27E
AMC 340973	SG 18	513	61			SEC33-T06S-R27E
AMC 340974	SG 19	513	63			SEC33-T06S-R27E
AMC 340975	SG 20	513	65			SEC33-T06S-R27E
AMC 340976	SG 21	513	67			SEC34-T06S-R27E
AMC 340977	SG 22	513	69			SEC34-T06S-R27E
AMC 340978	SG 23	513	71			SEC27-T06S-R27E
AMC 340979	SG 24	513	73			SEC34-T06S-R27E
AMC 340980	SG 25	513	75			SEC34-T06S-R27E
AMC 340981	SG 26	513	77			SEC27-T06S-R27E
AMC 340982	SG 27	513	79			SEC27-T06S-R27E
AMC 340983	SG 28	513	81			SEC26-T06S-R27E
AMC 340984	SG 29	513	83			SEC27-T06S-R27E
AMC 340985	SG 30	513	85			SEC27-T06S-R27E
AMC 340986	SG 31	513	87			SEC26-T06S-R27E
AMC 340987	SG 32	513	89			SEC27-T06S-R27E
AMC 340988	SG 33	513	91			SEC27-T06S-R27E
AMC 340989	SG 34	513	93			SEC23-T06S-R27E
AMC 340990	SG 35	513	95			SEC23-T06S-R27E
AMC 340991	SG 36	513	97			SEC23-T06S-R27E
AMC 340992	SG 37	513	99			SEC23-T06S-R27E
AMC 340993	SG 38	513	101			SEC28-T06S-R27E
AMC 340994	SG 39	513	103			SEC24-T06S-R27E
AMC 340995	SG 40	513	105			SEC25-T06S-R27E
AMC 340996	SG 41	513	107			SEC27-T06S-R27E

RECEIVED  
 10/15/11  
 11:51 AM

EXHIBIT A

AMC 340997	SG 42	513	109	SEC28-T06S-R27E
AMC 340998	SG 43	513	111	SEC28-T06S-R27E
AMC 340999	SG 44	513	113	SEC23-T06S-R27E
AMC 341000	SG 45	513	115	SEC23-T06S-R27E
AMC 341001	SG 46	513	117	SEC25-T06S-R27E
AMC 341002	SZ 1	513	119	SEC29-T06S-R27E
AMC 341003	SZ 2	513	121	SEC29-T06S-R27E
AMC 341004	SZ 3	513	123	SEC29-T06S-R27E
AMC 341005	SZ 4	513	125	SEC29-T06S-R27E
AMC 341006	SZ 5	513	127	SEC29-T06S-R27E
AMC 341007	SZ 6	513	129	SEC29-T06S-R27E
AMC 341008	SZ 7	513	131	SEC29-T06S-R27E
AMC 341009	SZ 8	513	133	SEC29-T06S-R27E
AMC 341010	SZ 9	513	135	SEC29-T06S-R27E
AMC 341011	SZ 10	513	137	SEC29-T06S-R27E
AMC 341012	SZ 11	513	139	SEC29-T06S-R27E
AMC 341013	SZ 12	513	141	SEC29-T06S-R27E
AMC 341014	SZ 13	513	143	SEC29-T06S-R27E
AMC 341015	SZ 14	513	145	SEC20-T06S-R27E
AMC 341016	SZ 15	513	147	SEC20-T06S-R27E
AMC 341017	SZ 16	513	149	SEC20-T06S-R27E
AMC 341018	SZ 17	513	151	SEC20-T06S-R27E
AMC 341019	SZ 18	513	153	SEC20-T06S-R27E
AMC 341020	SZ 19	513	155	SEC20-T06S-R27E
AMC 341021	SZ 20	513	157	SEC20-T06S-R27E
AMC 341022	SZ 21	513	159	SEC20-T06S-R27E
AMC 341023	SZ 22	513	161	SEC20-T06S-R27E
AMC 341024	SZ 23	513	163	SEC20-T06S-R27E
AMC 341025	SZ 24	513	165	SEC20-T06S-R27E
AMC 341026	SZ 25	513	167	SEC20-T06S-R27E
AMC 341652	BH 4B	514	787	SEC26-T05S-R26E
AMC 341653	BH 6B	514	789	SEC26-T05S-R26E
AMC 341654	BH 8B	514	791	SEC26-T05S-R26E
AMC 341655	BH 10B	514	793	SEC25-T05S-R26E
AMC 341656	BH 12B	514	795	SEC25-T05S-R26E
AMC 341657	BH 14B	514	797	SEC25-T05S-R26E
AMC 341658	BH 16B	514	799	SEC25-T05S-R26E
AMC 341659	BH 18B	514	801	SEC25-T05S-R26E
AMC 341660	BH 20B	514	803	SEC25-T05S-R26E
AMC 341661	BH 22B	514	805	SEC24-T05S-R26E
AMC 341662	BH 25B	514	807	SEC25-T05S-R26E
AMC 341663	BH 26B	514	809	SEC25-T05S-R26E
AMC 341664	BH 27B	514	811	SEC25-T05S-R26E
AMC 341665	BH 28B	514	813	SEC25-T05S-R26E
AMC 341666	BH 29B	514	815	SEC25-T05S-R26E
AMC 341667	BH 30B	514	817	SEC25-T05S-R26E
AMC 341668	BH 31B	514	819	SEC25-T05S-R26E

RECEIVED  
 DIVISION OF  
 RECORDS  
 AND INFORMATION  
 ARIZONA  
 12 11 2013

EXHIBIT A

AMC 341669	BH 32B	514	821	SEC25-T05S-R26E
AMC 341670	BH 33B	514	823	SEC25-T05S-R26E
AMC 341671	BH 34B	514	825	SEC25-T05S-R26E
AMC 341672	BH 35B	514	827	SEC25-T05S-R26E
AMC 341673	BH 36B	514	829	SEC25-T05S-R26E
AMC 341674	BH 37B	514	831	SEC25-T05S-R26E
AMC 341675	BH 38B	514	833	SEC25-T05S-R26E
AMC 341676	BH 39B	514	835	SEC25-T05S-R26E
AMC 341677	BH 40B	514	837	SEC25-T05S-R26E
AMC 341678	BH 41B	514	839	SEC25-T05S-R26E
AMC 341679	BH 42B	514	841	SEC25-T05S-R26E
AMC 341680	BH 43B	514	843	SEC24-T05S-R26E
AMC 341681	BH 44B	514	845	SEC24-T05S-R26E
AMC 344116	SG 47	519	75	SEC26-T06S-R27E
AMC 344117	SG 48	519	77	SEC26-T06S-R27E
AMC 344118	SG 49	519	79	SEC26-T06S-R27E
AMC 344119	SG 50	519	81	SEC23-T06S-R27E
AMC 344120	SG 51	519	83	SEC24-T06S-R27E
AMC 344121	SG 52	519	85	SEC24-T06S-R27E
AMC 344122	SG 53	519	419	SEC27-T06S-R27E
AMC 430691	ROCKSTAR 001	2015-1345		SEC01-T06S-R27E
AMC 430692	ROCKSTAR 002	2015-1346		SEC01-T06S-R27E
AMC 430693	ROCKSTAR 003	2015-1347		SEC01-T06S-R27E
AMC 430694	ROCKSTAR 004	2015-1348		SEC01-T06S-R27E
AMC 430695	ROCKSTAR 005	2015-1349		SEC01-T06S-R27E
AMC 430696	ROCKSTAR 006	2015-1350		SEC01-T06S-R27E
AMC 430697	ROCKSTAR 007	2015-1351		SEC01-T06S-R27E
AMC 430698	ROCKSTAR 008	2015-1352		SEC01-T06S-R27E
AMC 430699	ROCKSTAR 009	2015-1353		SEC01-T06S-R27E
AMC 430700	ROCKSTAR 010	2015-1354		SEC01-T06S-R27E
AMC 430701	ROCKSTAR 011	2015-1355		SEC01-T06S-R27E
AMC 430702	ROCKSTAR 012	2015-1356		SEC01-T06S-R27E
AMC 430703	ROCKSTAR 013	2015-1357		SEC01-T06S-R27E
AMC 430704	ROCKSTAR 014	2015-1358		SEC01-T06S-R27E
AMC 430705	ROCKSTAR 015	2015-1359		SEC01-T06S-R27E
AMC 430706	ROCKSTAR 016	2015-1360		SEC01-T06S-R27E
AMC 430707	ROCKSTAR 017	2015-1361		SEC01-T06S-R27E
AMC 430708	ROCKSTAR 018	2015-1362		SEC01-T06S-R27E
AMC 430709	ROCKSTAR 019	2015-1363		SEC01-T06S-R27E
AMC 430710	ROCKSTAR 020	2015-1364		SEC01-T06S-R27E
AMC 430711	ROCKSTAR 021	2015-1365		SEC01-T06S-R27E
AMC 430712	ROCKSTAR 022	2015-1366		SEC01-T06S-R27E
AMC 430713	ROCKSTAR 023	2015-1367		SEC01-T06S-R27E
AMC 430714	ROCKSTAR 024	2015-1368		SEC01-T06S-R27E
AMC 430715	ROCKSTAR 025	2015-1369		SEC01-T06S-R27E
AMC 430716	ROCKSTAR 026	2015-1370		SEC01-T06S-R27E
AMC 430717	ROCKSTAR 027	2015-1371		SEC01-T06S-R27E

RECEIVED  
 FBI  
 IDENTIFICATION DIVISION  
 APR 2 2015  
 FBI

EXHIBIT A

AMC 430718	ROCKSTAR 028	2015-1372	SEC01-T06S-R27E
AMC 430719	ROCKSTAR 029	2015-1373	SEC01-T06S-R27E
AMC 430720	ROCKSTAR 030	2015-1374	SEC01-T06S-R27E
AMC 430721	ROCKSTAR 031	2015-1375	SEC01-T06S-R27E
AMC 430722	ROCKSTAR 032	2015-1376	SEC01-T06S-R27E
AMC 430723	ROCKSTAR 033	2015-1377	SEC01-T06S-R27E
AMC 430724	ROCKSTAR 034	2015-1378	SEC01-T06S-R27E
AMC 430725	ROCKSTAR 035	2015-1379	SEC01-T06S-R27E
AMC 430726	ROCKSTAR 036	2015-1380	SEC01-T06S-R27E
AMC 430751	ROCKSTAR 037	2015-1381	SEC02-T06S-R27E
AMC 430752	ROCKSTAR 038	2015-1382	SEC02-T06S-R27E
AMC 430753	ROCKSTAR 039	2015-1383	SEC02-T06S-R27E
AMC 430754	ROCKSTAR 040	2015-1384	SEC02-T06S-R27E
AMC 430755	ROCKSTAR 041	2015-1385	SEC02-T06S-R27E
AMC 430756	ROCKSTAR 042	2015-1386	SEC02-T06S-R27E
AMC 430757	ROCKSTAR 043	2015-1387	SEC02-T06S-R27E
AMC 430758	ROCKSTAR 044	2015-1388	SEC02-T06S-R27E
AMC 430759	ROCKSTAR 045	2015-1389	SEC02-T06S-R27E
AMC 430760	ROCKSTAR 046	2015-1390	SEC02-T06S-R27E
AMC 430761	ROCKSTAR 047	2015-1391	SEC02-T06S-R27E
AMC 430762	ROCKSTAR 048	2015-1392	SEC02-T06S-R27E
AMC 430763	ROCKSTAR 049	2015-1393	SEC02-T06S-R27E
AMC 430764	ROCKSTAR 050	2015-1394	SEC02-T06S-R27E
AMC 430765	ROCKSTAR 051	2015-1395	SEC02-T06S-R27E
AMC 430766	ROCKSTAR 052	2015-1396	SEC02-T06S-R27E
AMC 430767	ROCKSTAR 053	2015-1397	SEC02-T06S-R27E
AMC 430768	ROCKSTAR 054	2015-1398	SEC02-T06S-R27E
AMC 430769	ROCKSTAR 055	2015-1399	SEC02-T06S-R27E
AMC 430770	ROCKSTAR 056	2015-1400	SEC02-T06S-R27E
AMC 430771	ROCKSTAR 057	2015-1401	SEC02-T06S-R27E
AMC 430772	ROCKSTAR 058	2015-1402	SEC02-T06S-R27E
AMC 430773	ROCKSTAR 059	2015-1403	SEC02-T06S-R27E
AMC 430774	ROCKSTAR 060	2015-1404	SEC02-T06S-R27E
AMC 430775	ROCKSTAR 061	2015-1405	SEC02-T06S-R27E
AMC 430776	ROCKSTAR 062	2015-1406	SEC02-T06S-R27E
AMC 430777	ROCKSTAR 063	2015-1407	SEC02-T06S-R27E
AMC 430778	ROCKSTAR 064	2015-1408	SEC02-T06S-R27E
AMC 430779	ROCKSTAR 065	2015-1409	SEC02-T06S-R27E
AMC 430780	ROCKSTAR 066	2015-1410	SEC02-T06S-R27E
AMC 430781	ROCKSTAR 067	2015-1411	SEC02-T06S-R27E
AMC 430782	ROCKSTAR 068	2015-1412	SEC02-T06S-R27E
AMC 430783	ROCKSTAR 069	2015-1413	SEC02-T06S-R27E
AMC 430784	ROCKSTAR 070	2015-1414	SEC02-T06S-R27E
AMC 430785	ROCKSTAR 071	2015-1415	SEC02-T06S-R27E
AMC 430786	ROCKSTAR 072	2015-1416	SEC02-T06S-R27E
AMC 430787	ROCKSTAR 073	2015-1417	SEC03-T06S-R27E
AMC 430788	ROCKSTAR 074	2015-1418	SEC03-T06S-R27E

RECEIVED  
DIPLOMA SERVICE OFFICE  
NOV 10 2015  
10:51 AM

EXHIBIT A

AMC 430789	ROCKSTAR 075	2015-1419	SEC03-T06S-R27E
AMC 430790	ROCKSTAR 076	2015-1420	SEC03-T06S-R27E
AMC 430791	ROCKSTAR 077	2015-1421	SEC03-T06S-R27E
AMC 430792	ROCKSTAR 078	2015-1422	SEC03-T06S-R27E
AMC 430793	ROCKSTAR 079	2015-1423	SEC03-T06S-R27E
AMC 430794	ROCKSTAR 080	2015-1424	SEC03-T06S-R27E
AMC 430795	ROCKSTAR 081	2015-1425	SEC03-T06S-R27E
AMC 430796	ROCKSTAR 082	2015-1426	SEC03-T06S-R27E
AMC 430797	ROCKSTAR 083	2015-1427	SEC03-T06S-R27E
AMC 430798	ROCKSTAR 084	2015-1428	SEC03-T06S-R27E
AMC 430799	ROCKSTAR 085	2015-1429	SEC03-T06S-R27E
AMC 430800	ROCKSTAR 086	2015-1430	SEC03-T06S-R27E
AMC 430801	ROCKSTAR 087	2015-1431	SEC03-T06S-R27E
AMC 430802	ROCKSTAR 088	2015-1432	SEC03-T06S-R27E
AMC 430803	ROCKSTAR 089	2015-1433	SEC03-T06S-R27E
AMC 430804	ROCKSTAR 090	2015-1434	SEC03-T06S-R27E
AMC 430805	ROCKSTAR 091	2015-1435	SEC12-T06S-R27E
AMC 430806	ROCKSTAR 092	2015-1436	SEC12-T06S-R27E
AMC 430807	ROCKSTAR 093	2015-1437	SEC12-T06S-R27E
AMC 430808	ROCKSTAR 094	2015-1438	SEC12-T06S-R27E
AMC 430809	ROCKSTAR 095	2015-1439	SEC12-T06S-R27E
AMC 430810	ROCKSTAR 096	2015-1440	SEC12-T06S-R27E
AMC 430811	ROCKSTAR 097	2015-1441	SEC12-T06S-R27E
AMC 430812	ROCKSTAR 098	2015-1442	SEC12-T06S-R27E
AMC 430813	ROCKSTAR 099	2015-1443	SEC12-T06S-R27E
AMC 430814	ROCKSTAR 100	2015-1444	SEC12-T06S-R27E
AMC 430815	ROCKSTAR 101	2015-1445	SEC12-T06S-R27E
AMC 430816	ROCKSTAR 102	2015-1446	SEC12-T06S-R27E
AMC 430817	ROCKSTAR 103	2015-1447	SEC12-T06S-R27E
AMC 430818	ROCKSTAR 104	2015-1448	SEC12-T06S-R27E
AMC 430819	ROCKSTAR 105	2015-1449	SEC12-T06S-R27E
AMC 430820	ROCKSTAR 106	2015-1450	SEC12-T06S-R27E
AMC 430821	ROCKSTAR 107	2015-1451	SEC12-T06S-R27E
AMC 430822	ROCKSTAR 108	2015-1452	SEC12-T06S-R27E
AMC 430823	ROCKSTAR 109	2015-1453	SEC12-T06S-R27E
AMC 430824	ROCKSTAR 110	2015-1454	SEC12-T06S-R27E
AMC 430825	ROCKSTAR 111	2015-1455	SEC12-T06S-R27E
AMC 430826	ROCKSTAR 112	2015-1456	SEC12-T06S-R27E
AMC 430827	ROCKSTAR 113	2015-1457	SEC12-T06S-R26E
AMC 430828	ROCKSTAR 114	2015-1458	SEC12-T06S-R26E
AMC 430829	ROCKSTAR 115	2015-1459	SEC12-T06S-R27E
AMC 430830	ROCKSTAR 116	2015-1460	SEC12-T06S-R27E
AMC 430831	ROCKSTAR 117	2015-1461	SEC12-T06S-R27E
AMC 430832	ROCKSTAR 118	2015-1462	SEC12-T06S-R27E
AMC 430833	ROCKSTAR 119	2015-1463	SEC12-T06S-R27E
AMC 430834	ROCKSTAR 120	2015-1464	SEC12-T06S-R27E
AMC 430835	ROCKSTAR 121	2015-1465	SEC12-T06S-R27E

RECEIVED  
 2015  
 APR 21 10 23 AM  
 SEC12-T06S-R27E



EXHIBIT A

AMC 430836	ROCKSTAR 122	2015-1466	SEC13-T06S-R27E
AMC 430889	Red Bull-1	2015-1696	SEC27-T05S-R25E
AMC 430890	Red Bull-2	2015-1697	SEC27-T05S-R25E
AMC 430891	Red Bull-3	2015-1698	SEC27-T05S-R25E
AMC 430892	Red Bull-4	2015-1699	SEC27-T05S-R25E
AMC 430893	Red Bull-5	2015-1700	SEC27-T05S-R25E
AMC 430894	Red Bull-6	2015-1701	SEC27-T05S-R25E
AMC 430895	Red Bull-7	2015-1702	SEC27-T05S-R25E
AMC 430896	Red Bull-8	2015-1703	SEC27-T05S-R25E
AMC 430897	Red Bull-9	2015-1704	SEC27-T05S-R25E
AMC 430898	Red Bull-10	2015-1705	SEC27-T05S-R25E
AMC 430899	Red Bull-11	2015-1706	SEC27-T05S-R25E
AMC 430900	Red Bull-12	2015-1707	SEC27-T05S-R25E
AMC 430901	Red Bull-13	2015-1708	SEC27-T05S-R25E
AMC 430902	Red Bull-14	2015-1709	SEC27-T05S-R25E
AMC 430903	Red Bull-15	2015-1710	SEC27-T05S-R25E
AMC 430904	Red Bull-16	2015-1711	SEC27-T05S-R25E
AMC 430905	Red Bull-17	2015-1712	SEC27-T05S-R25E
AMC 430906	Red Bull-18	2015-1713	SEC27-T05S-R25E
AMC 430907	Red Bull-19	2015-1714	SEC27-T05S-R25E
AMC 430908	Red Bull-20	2015-1715	SEC27-T05S-R25E
AMC 430909	Red Bull-21	2015-1716	SEC27-T05S-R25E
AMC 430910	Red Bull-22	2015-1717	SEC27-T05S-R25E
AMC 430911	Red Bull-23	2015-1718	SEC27-T05S-R25E
AMC 430912	Red Bull-24	2015-1719	SEC27-T05S-R25E
AMC 430913	Red Bull-25	2015-1720	SEC27-T05S-R25E
AMC 430914	Red Bull-26	2015-1721	SEC27-T05S-R25E
AMC 430915	Red Bull-27	2015-1722	SEC27-T05S-R25E
AMC 430916	Red Bull-28	2015-1723	SEC27-T05S-R25E
AMC 430917	Red Bull-29	2015-1724	SEC27-T05S-R25E
AMC 430918	Red Bull-30	2015-1725	SEC27-T05S-R25E
AMC 430919	Red Bull-31	2015-1726	SEC27-T05S-R25E
AMC 430920	Red Bull-32	2015-1727	SEC27-T05S-R25E
AMC 430921	Red Bull-33	2015-1728	SEC27-T05S-R25E
AMC 430922	Red Bull-34	2015-1729	SEC27-T05S-R25E
AMC 430923	Red Bull-35	2015-1730	SEC27-T05S-R25E
AMC 430924	Red Bull-36	2015-1731	SEC27-T05S-R25E
AMC 430925	Red Bull-37	2015-1732	SEC34-T05S-R25E
AMC 430926	Red Bull-38	2015-1733	SEC34-T05S-R25E
AMC 430927	Red Bull-39	2015-1734	SEC34-T05S-R25E
AMC 430928	Red Bull-40	2015-1735	SEC34-T05S-R25E
AMC 430929	Red Bull-41	2015-1736	SEC34-T05S-R25E
AMC 430930	Red Bull-42	2015-1737	SEC34-T05S-R25E
AMC 430931	Red Bull-43	2015-1738	SEC34-T05S-R25E
AMC 430932	Red Bull-44	2015-1739	SEC34-T05S-R25E
AMC 430933	Red Bull-45	2015-1740	SEC34-T05S-R25E
AMC 430934	Red Bull-46	2015-1741	SEC34-T05S-R25E

RECEIVED  
 2015  
 APR 10 11:00 AM  
 SEC34-T05S-R25E

EXHIBIT A

AMC 430935	Red Bull-47	2015-1742	SEC34-T05S-R25E
AMC 430936	Red Bull-48	2015-1743	SEC34-T05S-R25E
AMC 430937	Red Bull-49	2015-1744	SEC34-T05S-R25E
AMC 430938	Red Bull-50	2015-1745	SEC34-T05S-R25E
AMC 430939	Red Bull-51	2015-1746	SEC34-T05S-R25E
AMC 430940	Red Bull-52	2015-1747	SEC34-T05S-R25E
AMC 430941	Red Bull-53	2015-1748	SEC34-T05S-R25E
AMC 430942	Red Bull-54	2015-1749	SEC34-T05S-R25E
AMC 430943	Red Bull-55	2015-1750	SEC34-T05S-R25E
AMC 430944	Red Bull-56	2015-1751	SEC34-T05S-R25E
AMC 430945	Red Bull-57	2015-1752	SEC34-T05S-R25E
AMC 430946	Red Bull-58	2015-1753	SEC34-T05S-R25E
AMC 430947	Red Bull-59	2015-1754	SEC34-T05S-R25E
AMC 430948	Red Bull-60	2015-1755	SEC34-T05S-R25E
AMC 430949	Red Bull-61	2015-1756	SEC34-T05S-R25E
AMC 430950	Red Bull-62	2015-1757	SEC34-T05S-R25E
AMC 430951	Red Bull-63	2015-1758	SEC34-T05S-R25E
AMC 430952	Red Bull-64	2015-1759	SEC34-T05S-R25E
AMC 430953	Red Bull-65	2015-1760	SEC34-T05S-R25E
AMC 430954	Red Bull-66	2015-1761	SEC34-T05S-R25E
AMC 430955	Red Bull-67	2015-1762	SEC34-T05S-R25E
AMC 430956	Red Bull-68	2015-1763	SEC34-T05S-R25E
AMC 430957	Red Bull-69	2015-1764	SEC34-T05S-R25E
AMC 430958	Red Bull-70	2015-1765	SEC34-T05S-R25E
AMC 430959	Red Bull-71	2015-1766	SEC34-T05S-R25E
AMC 430960	Red Bull-72	2015-1767	SEC34-T05S-R25E
AMC 430961	Red Bull-73	2015-1768	SEC33-T05S-R25E
AMC 430962	Red Bull-74	2015-1769	SEC33-T05S-R25E
AMC 430963	Red Bull-75	2015-1770	SEC33-T05S-R25E
AMC 430964	Red Bull-76	2015-1771	SEC33-T05S-R25E
AMC 430965	Red Bull-77	2015-1772	SEC33-T05S-R25E
AMC 430966	Red Bull-78	2015-1773	SEC33-T05S-R25E
AMC 430967	Red Bull-79	2015-1774	SEC33-T05S-R25E
AMC 430968	Red Bull-80	2015-1775	SEC33-T05S-R25E
AMC 430969	Red Bull-81	2015-1776	SEC33-T05S-R25E
AMC 430970	Red Bull-82	2015-1777	SEC33-T05S-R25E
AMC 430971	Red Bull-83	2015-1778	SEC33-T05S-R25E
AMC 430972	Red Bull-84	2015-1779	SEC33-T05S-R25E
AMC 430973	Red Bull-85	2015-1780	SEC33-T05S-R25E
AMC 430974	Red Bull-86	2015-1781	SEC33-T05S-R25E
AMC 430975	Red Bull-87	2015-1782	SEC33-T05S-R25E
AMC 430976	Red Bull-88	2015-1783	SEC33-T05S-R25E
AMC 430977	Red Bull-89	2015-1784	SEC33-T05S-R25E
AMC 430978	Red Bull-90	2015-1785	SEC33-T05S-R25E
AMC 430979	Red Bull-91	2015-1786	SEC33-T05S-R25E
AMC 430980	Red Bull-92	2015-1787	SEC33-T05S-R25E
AMC 430981	Red Bull-93	2015-1788	SEC33-T05S-R25E

RECEIVED  
BIRMINGHAM OFFICE  
NOV 20 2015  
11 34  
AMC 430981

EXHIBIT A

AMC 430982	Red Bull-94	2015-1789	SEC33-T05S-R25E
AMC 430983	Red Bull-95	2015-1790	SEC33-T05S-R25E
AMC 430984	Red Bull-96	2015-1791	SEC33-T05S-R25E
AMC 430985	Red Bull-97	2015-1792	SEC33-T05S-R25E
AMC 430986	Red Bull-98	2015-1793	SEC33-T05S-R25E
AMC 430987	Red Bull-99	2015-1794	SEC33-T05S-R25E
AMC 430988	Red Bull-100	2015-1795	SEC33-T05S-R25E
AMC 430989	Red Bull-101	2015-1796	SEC33-T05S-R25E
AMC 430990	Red Bull-102	2015-1797	SEC33-T05S-R25E
AMC 430991	Red Bull-103	2015-1798	SEC33-T05S-R25E
AMC 430992	Red Bull-104	2015-1799	SEC33-T05S-R25E
AMC 430993	Red Bull-105	2015-1800	SEC33-T05S-R25E
AMC 430994	Red Bull-106	2015-1801	SEC33-T05S-R25E
AMC 430995	Red Bull-107	2015-1802	SEC33-T05S-R25E
AMC 430996	Red Bull-108	2015-1803	SEC33-T05S-R25E
AMC 430997	Red Bull-109	2015-1804	SEC28-T05S-R25E
AMC 430998	Red Bull-110	2015-1805	SEC28-T05S-R25E
AMC 430999	Red Bull-111	2015-1806	SEC28-T05S-R25E
AMC 431000	Red Bull-112	2015-1807	SEC28-T05S-R25E
AMC 431001	Red Bull-113	2015-1808	SEC28-T05S-R25E
AMC 431002	Red Bull-114	2015-1809	SEC28-T05S-R25E
AMC 431003	Red Bull-115	2015-1810	SEC28-T05S-R25E
AMC 431004	Red Bull-116	2015-1811	SEC28-T05S-R25E
AMC 431005	Red Bull-117	2015-1812	SEC28-T05S-R25E
AMC 431006	Red Bull-118	2015-1813	SEC28-T05S-R25E
AMC 431007	Red Bull-119	2015-1814	SEC28-T05S-R25E
AMC 431008	Red Bull-120	2015-1815	SEC28-T05S-R25E
AMC 431009	Red Bull-121	2015-1816	SEC28-T05S-R25E
AMC 431010	Red Bull-122	2015-1817	SEC28-T05S-R25E
AMC 431011	Red Bull-123	2015-1818	SEC28-T05S-R25E
AMC 431012	Red Bull-124	2015-1819	SEC28-T05S-R25E
AMC 431013	Red Bull-125	2015-1820	SEC28-T05S-R25E
AMC 431014	Red Bull-126	2015-1821	SEC28-T05S-R25E
AMC 431015	Red Bull-127	2015-1822	SEC28-T05S-R25E
AMC 431016	Red Bull-128	2015-1823	SEC28-T05S-R25E
AMC 431017	Red Bull-129	2015-1824	SEC28-T05S-R25E
AMC 431018	Red Bull-130	2015-1825	SEC28-T05S-R25E
AMC 431019	Red Bull-131	2015-1826	SEC28-T05S-R25E
AMC 431020	Red Bull-132	2015-1827	SEC28-T05S-R25E
AMC 431021	Red Bull-133	2015-1828	SEC28-T05S-R25E
AMC 431022	Red Bull-134	2015-1829	SEC28-T05S-R25E
AMC 431023	Red Bull-135	2015-1830	SEC28-T05S-R25E
AMC 431024	Red Bull-136	2015-1831	SEC28-T05S-R25E
AMC 431025	Red Bull-137	2015-1832	SEC28-T05S-R25E
AMC 431026	Red Bull-138	2015-1833	SEC28-T05S-R25E
AMC 431027	Red Bull-139	2015-1834	SEC28-T05S-R25E
AMC 431028	Red Bull-140	2015-1835	SEC28-T05S-R25E

RECEIVED  
SEC28-T05S-R25E

EXHIBIT A

AMC 431029	Red Bull-141	2015-1836	SEC28-T05S-R25E
AMC 431030	Red Bull-142	2015-1837	SEC28-T05S-R25E
AMC 431031	Red Bull-143	2015-1838	SEC28-T05S-R25E
AMC 431032	Red Bull-144	2015-1839	SEC28-T05S-R25E
AMC 431033	Red Bull-316	2015-1840	SEC16-T05S-R25E
AMC 431034	Red Bull-317	2015-1841	SEC16-T05S-R25E
AMC 431035	Red Bull-318	2015-1842	SEC16-T05S-R25E
AMC 431036	Red Bull-319	2015-1843	SEC16-T05S-R25E
AMC 431037	Red Bull-320	2015-1844	SEC16-T05S-R25E
AMC 431038	Red Bull-321	2015-1845	SEC16-T05S-R25E
AMC 431039	Red Bull-322	2015-1846	SEC16-T05S-R25E
AMC 431040	Red Bull-323	2015-1847	SEC16-T05S-R25E
AMC 431041	Red Bull-324	2015-1848	SEC16-T05S-R25E
AMC 431042	Red Bull-325	2015-1849	SEC16-T05S-R25E
AMC 431043	Red Bull-326	2015-1850	SEC16-T05S-R25E
AMC 431044	Red Bull-327	2015-1851	SEC16-T05S-R25E
AMC 431045	Red Bull-328	2015-1852	SEC16-T05S-R25E
AMC 431046	Red Bull-329	2015-1853	SEC16-T05S-R25E
AMC 431047	Red Bull-330	2015-1854	SEC16-T05S-R25E
AMC 431048	Red Bull-331	2015-1855	SEC16-T05S-R25E
AMC 431049	Red Bull-332	2015-1856	SEC16-T05S-R25E
AMC 431050	Red Bull-333	2015-1857	SEC16-T05S-R25E
AMC 431051	Red Bull-334	2015-1858	SEC16-T05S-R25E
AMC 431052	Red Bull-335	2015-1859	SEC16-T05S-R25E
AMC 431053	Red Bull-336	2015-1860	SEC16-T05S-R25E
AMC 431054	Red Bull-337	2015-1861	SEC16-T05S-R25E
AMC 431055	Red Bull-338	2015-1862	SEC16-T05S-R25E
AMC 431056	Red Bull-339	2015-1863	SEC16-T05S-R25E
AMC 431057	Red Bull-340	2015-1864	SEC16-T05S-R25E
AMC 431058	Red Bull-341	2015-1865	SEC16-T05S-R25E
AMC 431059	Red Bull-342	2015-1866	SEC16-T05S-R25E
AMC 431060	Red Bull-343	2015-1867	SEC16-T05S-R25E
AMC 431061	Red Bull-344	2015-1868	SEC16-T05S-R25E
AMC 431062	Red Bull-345	2015-1869	SEC16-T05S-R25E
AMC 431063	Red Bull-346	2015-1870	SEC16-T05S-R25E
AMC 431064	Red Bull-347	2015-1871	SEC16-T05S-R25E
AMC 431065	Red Bull-348	2015-1872	SEC16-T05S-R25E
AMC 431066	Red Bull-349	2015-1873	SEC16-T05S-R25E
AMC 431067	Red Bull-350	2015-1874	SEC16-T05S-R25E
AMC 431068	Red Bull-351	2015-1875	SEC16-T05S-R25E
AMC 431071	ROCKSTAR 123	2015-1913	SEC13-T06S-R27E
AMC 431072	ROCKSTAR 124	2015-1914	SEC13-T06S-R27E
AMC 431073	ROCKSTAR 125	2015-1915	SEC13-T06S-R27E
AMC 431074	ROCKSTAR 126	2015-1916	SEC24-T06S-R27E
AMC 431075	ROCKSTAR 127	2015-1917	SEC13-T06S-R27E
AMC 431076	ROCKSTAR 128	2015-1918	SEC13-T06S-R27E
AMC 431077	ROCKSTAR 129	2015-1919	SEC13-T06S-R27E

RECEIVED  
 JUN 13 2015  
 9:13 AM

EXHIBIT A

AMC 431078	ROCKSTAR 130	2015-1920	SEC13-T06S-R27E
AMC 431079	ROCKSTAR 131	2015-1921	SEC13-T06S-R27E
AMC 431080	ROCKSTAR 132	2015-1922	SEC13-T06S-R27E
AMC 431081	ROCKSTAR 133	2015-1923	SEC13-T06S-R27E
AMC 431082	ROCKSTAR 134	2015-1924	SEC13-T06S-R27E
AMC 431083	ROCKSTAR 135	2015-1925	SEC13-T06S-R27E
AMC 431084	ROCKSTAR 136	2015-1926	SEC13-T06S-R27E
AMC 431085	ROCKSTAR 137	2015-1927	SEC13-T06S-R27E
AMC 431086	ROCKSTAR 138	2015-1928	SEC13-T06S-R27E
AMC 431087	ROCKSTAR 139	2015-1929	SEC13-T06S-R27E
AMC 431088	ROCKSTAR 140	2015-1930	SEC13-T06S-R27E
AMC 431089	ROCKSTAR 141	2015-1931	SEC13-T06S-R27E
AMC 431090	ROCKSTAR 142	2015-1932	SEC13-T06S-R27E
AMC 431091	ROCKSTAR 143	2015-1933	SEC13-T06S-R27E
AMC 431092	ROCKSTAR 144	2015-1934	SEC13-T06S-R27E
AMC 431093	ROCKSTAR 145	2015-1935	SEC13-T06S-R27E
AMC 431094	ROCKSTAR 146	2015-1936	SEC13-T06S-R27E
AMC 431095	ROCKSTAR 147	2015-1937	SEC13-T06S-R27E
AMC 431096	ROCKSTAR 148	2015-1938	SEC13-T06S-R27E
AMC 431097	ROCKSTAR 149	2015-1939	SEC13-T06S-R27E
AMC 431098	ROCKSTAR 150	2015-1940	SEC13-T06S-R27E
AMC 431099	ROCKSTAR 151	2015-1941	SEC24-T06S-R27E
AMC 431100	ROCKSTAR 152	2015-1942	SEC24-T06S-R27E
AMC 431101	ROCKSTAR 153	2015-1943	SEC24-T06S-R27E
AMC 431102	ROCKSTAR 154	2015-1944	SEC24-T06S-R27E
AMC 431103	ROCKSTAR 155	2015-1945	SEC24-T06S-R27E
AMC 431104	ROCKSTAR 156	2015-1946	SEC24-T06S-R27E
AMC 431105	ROCKSTAR 157	2015-1947	SEC24-T06S-R27E
AMC 431106	ROCKSTAR 158	2015-1948	SEC24-T06S-R27E
AMC 431107	ROCKSTAR 159	2015-1949	SEC24-T06S-R27E
AMC 431108	ROCKSTAR 160	2015-1950	SEC24-T06S-R27E
AMC 431109	ROCKSTAR 161	2015-1951	SEC24-T06S-R27E
AMC 431110	ROCKSTAR 162	2015-1952	SEC24-T06S-R27E
AMC 431111	ROCKSTAR 163	2015-1953	SEC24-T06S-R27E
AMC 431112	ROCKSTAR 164	2015-1954	SEC24-T06S-R27E
AMC 431113	ROCKSTAR 165	2015-1955	SEC24-T06S-R27E
AMC 431114	ROCKSTAR 166	2015-1956	SEC24-T06S-R27E
AMC 431115	ROCKSTAR 167	2015-1957	SEC24-T06S-R27E
AMC 431116	ROCKSTAR 168	2015-1958	SEC24-T06S-R27E
AMC 431117	ROCKSTAR 169	2015-1959	SEC24-T06S-R27E
AMC 431118	ROCKSTAR 170	2015-1960	SEC24-T06S-R27E
AMC 431119	ROCKSTAR 171	2015-1961	SEC24-T06S-R27E
AMC 431120	ROCKSTAR 172	2015-1962	SEC23-T06S-R27E
AMC 431121	MONSTER-001	2015-1963	SEC30-T05S-R27E
AMC 431122	MONSTER-002	2015-1964	SEC30-T05S-R27E
AMC 431123	MONSTER-003	2015-1965	SEC30-T05S-R27E
AMC 431124	MONSTER-004	2015-1966	SEC30-T05S-R27E

RECEIVED  
 ELIMINATED OFFICE  
 2015-11-11  
 11:00 AM

EXHIBIT A

AMC 431125	MONSTER-005	2015-1967	SEC30-T05S-R27E
AMC 431126	MONSTER-006	2015-1968	SEC30-T05S-R27E
AMC 431127	MONSTER-007	2015-1969	SEC30-T05S-R27E
AMC 431128	MONSTER-008	2015-1970	SEC30-T05S-R27E
AMC 431129	MONSTER-009	2015-1971	SEC30-T05S-R27E
AMC 431130	MONSTER-010	2015-1972	SEC30-T05S-R27E
AMC 431131	MONSTER-011	2015-1973	SEC30-T05S-R27E
AMC 431132	MONSTER-012	2015-1974	SEC30-T05S-R27E
AMC 431133	MONSTER-013	2015-1975	SEC30-T05S-R27E
AMC 431134	MONSTER-014	2015-1976	SEC30-T05S-R27E
AMC 431135	MONSTER-015	2015-1977	SEC30-T05S-R27E
AMC 431136	MONSTER-016	2015-1978	SEC30-T05S-R27E
AMC 431137	MONSTER-017	2015-1979	SEC30-T05S-R27E
AMC 431138	MONSTER-018	2015-1980	SEC30-T05S-R27E
AMC 431139	MONSTER-019	2015-1981	SEC30-T05S-R27E
AMC 431140	MONSTER-020	2015-1982	SEC30-T05S-R27E
AMC 431141	MONSTER-021	2015-1983	SEC30-T05S-R27E
AMC 431142	MONSTER-022	2015-1984	SEC30-T05S-R27E
AMC 431143	MONSTER-023	2015-1985	SEC30-T05S-R27E
AMC 431144	MONSTER-024	2015-1986	SEC30-T05S-R27E
AMC 431145	MONSTER-025	2015-1987	SEC30-T05S-R27E
AMC 431146	MONSTER-026	2015-1988	SEC30-T05S-R27E
AMC 431147	MONSTER-027	2015-1989	SEC30-T05S-R27E
AMC 431148	MONSTER-028	2015-1990	SEC30-T05S-R27E
AMC 431149	MONSTER-029	2015-1991	SEC30-T05S-R27E
AMC 431150	MONSTER-030	2015-1992	SEC30-T05S-R27E
AMC 431151	MONSTER-031	2015-1993	SEC30-T05S-R27E
AMC 431152	MONSTER-032	2015-1994	SEC30-T05S-R27E
AMC 431153	MONSTER-033	2015-1995	SEC30-T05S-R27E
AMC 431154	MONSTER-034	2015-1996	SEC30-T05S-R27E
AMC 431155	MONSTER-035	2015-1997	SEC30-T05S-R27E
AMC 431156	MONSTER-036	2015-1998	SEC30-T05S-R27E
AMC 431157	MONSTER-037	2015-1999	SEC29-T05S-R27E
AMC 431158	MONSTER-038	2015-2000	SEC29-T05S-R27E
AMC 431159	MONSTER-039	2015-2001	SEC29-T05S-R27E
AMC 431160	MONSTER-040	2015-2002	SEC29-T05S-R27E
AMC 431161	MONSTER-041	2015-2003	SEC29-T05S-R27E
AMC 431162	MONSTER-042	2015-2004	SEC29-T05S-R27E
AMC 431163	MONSTER-043	2015-2005	SEC29-T05S-R27E
AMC 431164	MONSTER-044	2015-2006	SEC29-T05S-R27E
AMC 431165	MONSTER-045	2015-2007	SEC29-T05S-R27E
AMC 431166	MONSTER-046	2015-2008	SEC29-T05S-R27E
AMC 431167	MONSTER-047	2015-2009	SEC29-T05S-R27E
AMC 431168	MONSTER-048	2015-2010	SEC29-T05S-R27E
AMC 431169	MONSTER-049	2015-2011	SEC29-T05S-R27E
AMC 431170	MONSTER-050	2015-2012	SEC29-T05S-R27E
AMC 431171	MONSTER-051	2015-2013	SEC29-T05S-R27E

PHOENIX, ARIZONA  
NOV 13 2013  
11:34 AM

EXHIBIT A

AMC 431172	MONSTER-052	2015-2014	SEC29-T05S-R27E
AMC 431173	MONSTER-053	2015-2015	SEC29-T05S-R27E
AMC 431174	MONSTER-054	2015-2016	SEC29-T05S-R27E
AMC 431175	MONSTER-055	2015-2017	SEC29-T05S-R27E
AMC 431176	MONSTER-056	2015-2018	SEC29-T05S-R27E
AMC 431177	MONSTER-057	2015-2019	SEC29-T05S-R27E
AMC 431178	MONSTER-058	2015-2020	SEC29-T05S-R27E
AMC 431179	MONSTER-059	2015-2021	SEC29-T05S-R27E
AMC 431180	MONSTER-060	2015-2022	SEC29-T05S-R27E
AMC 431181	MONSTER-061	2015-2023	SEC29-T05S-R27E
AMC 431182	MONSTER-062	2015-2024	SEC29-T05S-R27E
AMC 431183	MONSTER-063	2015-2025	SEC29-T05S-R27E
AMC 431184	MONSTER-064	2015-2026	SEC29-T05S-R27E
AMC 431185	MONSTER-065	2015-2027	SEC29-T05S-R27E
AMC 431186	MONSTER-066	2015-2028	SEC29-T05S-R27E
AMC 431187	MONSTER-067	2015-2029	SEC29-T05S-R27E
AMC 431188	MONSTER-068	2015-2030	SEC29-T05S-R27E
AMC 431189	MONSTER-069	2015-2031	SEC29-T05S-R27E
AMC 431190	MONSTER-070	2015-2032	SEC29-T05S-R27E
AMC 431191	MONSTER-071	2015-2033	SEC29-T05S-R27E
AMC 431192	MONSTER-072	2015-2034	SEC29-T05S-R27E
AMC 431193	MONSTER-073	2015-2035	SEC28-T05S-R27E
AMC 431194	MONSTER-074	2015-2036	SEC28-T05S-R27E
AMC 431195	MONSTER-075	2015-2037	SEC28-T05S-R27E
AMC 431196	MONSTER-076	2015-2038	SEC28-T05S-R27E
AMC 431197	MONSTER-077	2015-2039	SEC28-T05S-R27E
AMC 431198	MONSTER-078	2015-2040	SEC28-T05S-R27E
AMC 431199	MONSTER-079	2015-2041	SEC28-T05S-R27E
AMC 431200	MONSTER-080	2015-2042	SEC28-T05S-R27E
AMC 431201	MONSTER-081	2015-2043	SEC28-T05S-R27E
AMC 431202	MONSTER-082	2015-2044	SEC28-T05S-R27E
AMC 431203	MONSTER-083	2015-2045	SEC28-T05S-R27E
AMC 431204	MONSTER-084	2015-2046	SEC28-T05S-R27E
AMC 431205	MONSTER-085	2015-2047	SEC28-T05S-R27E
AMC 431206	MONSTER-086	2015-2048	SEC28-T05S-R27E
AMC 431207	MONSTER-087	2015-2049	SEC28-T05S-R27E
AMC 431208	MONSTER-088	2015-2050	SEC28-T05S-R27E
AMC 431209	MONSTER-089	2015-2051	SEC28-T05S-R27E
AMC 431210	MONSTER-090	2015-2052	SEC28-T05S-R27E
AMC 431211	MONSTER-091	2015-2053	SEC28-T05S-R27E
AMC 431212	MONSTER-092	2015-2054	SEC28-T05S-R27E
AMC 431213	MONSTER-093	2015-2055	SEC28-T05S-R27E
AMC 431214	MONSTER-094	2015-2056	SEC28-T05S-R27E
AMC 431215	MONSTER-095	2015-2057	SEC28-T05S-R27E
AMC 431216	MONSTER-096	2015-2058	SEC28-T05S-R27E
AMC 431217	MONSTER-097	2015-2059	SEC28-T05S-R27E
AMC 431218	MONSTER-098	2015-2060	SEC28-T05S-R27E

2011 FEB 12 P 12:34  
 POLICE, ARIZONA

EXHIBIT A

AMC 431219	MONSTER-099	2015-2061	SEC28-T05S-R27E
AMC 431220	MONSTER-100	2015-2062	SEC28-T05S-R27E
AMC 431221	MONSTER-101	2015-2063	SEC28-T05S-R27E
AMC 431222	MONSTER-102	2015-2064	SEC28-T05S-R27E
AMC 431223	MONSTER-103	2015-2065	SEC28-T05S-R27E
AMC 431224	MONSTER-104	2015-2066	SEC28-T05S-R27E
AMC 431225	MONSTER-105	2015-2067	SEC28-T05S-R27E
AMC 431226	MONSTER-106	2015-2068	SEC28-T05S-R27E
AMC 431227	MONSTER-107	2015-2069	SEC28-T05S-R27E
AMC 431228	MONSTER-108	2015-2070	SEC28-T05S-R27E
AMC 431229	MONSTER-149	2015-2071	SEC34-T05S-R27E
AMC 431230	MONSTER-150	2015-2072	SEC34-T05S-R27E
AMC 431231	MONSTER-159	2015-2073	SEC34-T05S-R27E
AMC 431232	MONSTER-160	2015-2074	SEC34-T05S-R27E
AMC 431233	MONSTER-161	2015-2075	SEC34-T05S-R27E
AMC 431234	MONSTER-162	2015-2076	SEC34-T05S-R27E
AMC 431235	MONSTER-163	2015-2077	SEC34-T05S-R27E
AMC 431236	MONSTER-164	2015-2078	SEC34-T05S-R27E
AMC 431237	MONSTER-165	2015-2079	SEC34-T05S-R27E
AMC 431238	MONSTER-166	2015-2080	SEC34-T05S-R27E
AMC 431239	MONSTER-167	2015-2081	SEC34-T05S-R27E
AMC 431240	MONSTER-168	2015-2082	SEC34-T05S-R27E
AMC 431241	MONSTER-169	2015-2083	SEC34-T05S-R27E
AMC 431242	MONSTER-170	2015-2084	SEC34-T05S-R27E
AMC 431243	MONSTER-171	2015-2085	SEC34-T05S-R27E
AMC 431244	MONSTER-172	2015-2086	SEC34-T05S-R27E
AMC 431245	MONSTER-173	2015-2087	SEC34-T05S-R27E
AMC 431246	MONSTER-174	2015-2088	SEC34-T05S-R27E
AMC 431247	MONSTER-175	2015-2089	SEC34-T05S-R27E
AMC 431248	MONSTER-176	2015-2090	SEC34-T05S-R27E
AMC 431249	MONSTER-331	2015-2091	SEC19-T05S-R27E
AMC 431250	MONSTER-332	2015-2092	SEC19-T05S-R27E
AMC 431251	MONSTER-333	2015-2093	SEC19-T05S-R27E
AMC 431252	MONSTER-334	2015-2094	SEC19-T05S-R27E
AMC 431253	MONSTER-335	2015-2095	SEC19-T05S-R27E
AMC 431254	MONSTER-336	2015-2096	SEC19-T05S-R27E
AMC 431255	MONSTER-337	2015-2097	SEC19-T05S-R27E
AMC 431256	MONSTER-338	2015-2098	SEC19-T05S-R27E
AMC 431257	MONSTER-339	2015-2099	SEC19-T05S-R27E
AMC 431258	MONSTER-340	2015-2100	SEC19-T05S-R27E
AMC 431259	MONSTER-341	2015-2101	SEC19-T05S-R27E
AMC 431260	MONSTER-342	2015-2102	SEC19-T05S-R27E
AMC 431261	MONSTER-343	2015-2103	SEC19-T05S-R27E
AMC 431262	MONSTER-344	2015-2104	SEC19-T05S-R27E
AMC 431263	MONSTER-345	2015-2105	SEC19-T05S-R27E
AMC 431264	MONSTER-346	2015-2106	SEC19-T05S-R27E
AMC 431265	MONSTER-347	2015-2107	SEC19-T05S-R27E

RECEIVED  
2015 APR 12 10 55 AM  
SECURITY DIVISION



EXHIBIT A

AMC 431266	MONSTER-348	2015-2108	SEC19-T05S-R27E
AMC 431267	MONSTER-349	2015-2109	SEC19-T05S-R27E
AMC 431268	MONSTER-350	2015-2110	SEC19-T05S-R27E
AMC 431269	MONSTER-351	2015-2111	SEC19-T05S-R27E
AMC 431270	MONSTER-352	2015-2112	SEC19-T05S-R27E
AMC 431271	MONSTER-353	2015-2113	SEC19-T05S-R27E
AMC 431272	MONSTER-354	2015-2114	SEC19-T05S-R27E
AMC 431273	MONSTER-355	2015-2115	SEC19-T05S-R27E
AMC 431274	MONSTER-356	2015-2116	SEC19-T05S-R27E
AMC 431275	MONSTER-357	2015-2117	SEC19-T05S-R27E
AMC 431276	MONSTER-358	2015-2118	SEC19-T05S-R27E
AMC 431277	MONSTER-359	2015-2119	SEC19-T05S-R27E
AMC 431278	MONSTER-360	2015-2120	SEC19-T05S-R27E
AMC 431279	MONSTER-361	2015-2121	SEC19-T05S-R27E
AMC 431280	MONSTER-362	2015-2122	SEC19-T05S-R27E
AMC 431281	MONSTER-363	2015-2123	SEC19-T05S-R27E
AMC 431282	MONSTER-364	2015-2124	SEC19-T05S-R27E
AMC 431283	MONSTER-365	2015-2125	SEC19-T05S-R27E
AMC 431284	MONSTER-366	2015-2126	SEC19-T05S-R27E
AMC 431317	Red Bull-145	2015-2200	SEC29-T05S-R25E
AMC 431318	Red Bull-146	2015-2201	SEC29-T05S-R25E
AMC 431319	Red Bull-147	2015-2202	SEC29-T05S-R25E
AMC 431320	Red Bull-148	2015-2203	SEC29-T05S-R25E
AMC 431321	Red Bull-149	2015-2204	SEC29-T05S-R25E
AMC 431322	Red Bull-150	2015-2205	SEC29-T05S-R25E
AMC 431323	Red Bull-151	2015-2206	SEC29-T05S-R25E
AMC 431324	Red Bull-152	2015-2207	SEC29-T05S-R25E
AMC 431325	Red Bull-153	2015-2208	SEC29-T05S-R25E
AMC 431326	Red Bull-154	2015-2209	SEC29-T05S-R25E
AMC 431327	Red Bull-155	2015-2210	SEC29-T05S-R25E
AMC 431328	Red Bull-156	2015-2211	SEC29-T05S-R25E
AMC 431329	Red Bull-157	2015-2212	SEC29-T05S-R25E
AMC 431330	Red Bull-158	2015-2213	SEC29-T05S-R25E
AMC 431331	Red Bull-159	2015-2214	SEC29-T05S-R25E
AMC 431332	Red Bull-160	2015-2215	SEC29-T05S-R25E
AMC 431333	Red Bull-161	2015-2216	SEC29-T05S-R25E
AMC 431334	Red Bull-162	2015-2217	SEC29-T05S-R25E
AMC 431335	Red Bull-163	2015-2218	SEC29-T05S-R25E
AMC 431336	Red Bull-164	2015-2219	SEC29-T05S-R25E
AMC 431337	Red Bull-165	2015-2220	SEC29-T05S-R25E
AMC 431338	Red Bull-166	2015-2221	SEC29-T05S-R25E
AMC 431339	Red Bull-167	2015-2222	SEC29-T05S-R25E
AMC 431340	Red Bull-168	2015-2223	SEC29-T05S-R25E
AMC 431341	Red Bull-169	2015-2224	SEC29-T05S-R25E
AMC 431342	Red Bull-170	2015-2225	SEC29-T05S-R25E
AMC 431343	Red Bull-171	2015-2226	SEC29-T05S-R25E
AMC 431344	Red Bull-172	2015-2227	SEC29-T05S-R25E

RECEIVED  
 2019 OCT 15 11:35  
 SEC29-T05S-R25E

EXHIBIT A

AMC 431345	Red Bull-173	2015-2228	SEC29-T05S-R25E
AMC 431346	Red Bull-174	2015-2229	SEC29-T05S-R25E
AMC 431347	Red Bull-175	2015-2230	SEC29-T05S-R25E
AMC 431348	Red Bull-176	2015-2231	SEC29-T05S-R25E
AMC 431349	Red Bull-177	2015-2232	SEC29-T05S-R25E
AMC 431350	Red Bull-178	2015-2233	SEC29-T05S-R25E
AMC 431351	Red Bull-179	2015-2234	SEC29-T05S-R25E
AMC 431352	Red Bull-180	2015-2235	SEC29-T05S-R25E
AMC 431353	Red Bull-181	2015-2236	SEC30-T05S-R25E
AMC 431354	Red Bull-182	2015-2237	SEC30-T05S-R25E
AMC 431355	Red Bull-183	2015-2238	SEC30-T05S-R25E
AMC 431356	Red Bull-184	2015-2239	SEC30-T05S-R25E
AMC 431357	Red Bull-185	2015-2240	SEC30-T05S-R25E
AMC 431358	Red Bull-186	2015-2241	SEC30-T05S-R25E
AMC 431359	Red Bull-187	2015-2242	SEC30-T05S-R25E
AMC 431360	Red Bull-188	2015-2243	SEC30-T05S-R25E
AMC 431361	Red Bull-189	2015-2244	SEC30-T05S-R25E
AMC 431362	Red Bull-190	2015-2245	SEC30-T05S-R25E
AMC 431363	Red Bull-191	2015-2246	SEC30-T05S-R25E
AMC 431364	Red Bull-192	2015-2247	SEC30-T05S-R25E
AMC 431365	Red Bull-193	2015-2248	SEC30-T05S-R25E
AMC 431366	Red Bull-194	2015-2249	SEC30-T05S-R25E
AMC 431367	Red Bull-195	2015-2250	SEC30-T05S-R25E
AMC 431368	Red Bull-196	2015-2251	SEC30-T05S-R25E
AMC 431369	Red Bull-197	2015-2252	SEC30-T05S-R25E
AMC 431370	Red Bull-198	2015-2253	SEC30-T05S-R25E
AMC 431371	Red Bull-199	2015-2254	SEC30-T05S-R25E
AMC 431372	Red Bull-200	2015-2255	SEC30-T05S-R25E
AMC 431373	Red Bull-201	2015-2256	SEC30-T05S-R25E
AMC 431374	Red Bull-202	2015-2257	SEC30-T05S-R25E
AMC 431375	Red Bull-203	2015-2258	SEC30-T05S-R25E
AMC 431376	Red Bull-204	2015-2259	SEC30-T05S-R25E
AMC 431377	Red Bull-205	2015-2260	SEC30-T05S-R25E
AMC 431378	Red Bull-206	2015-2261	SEC30-T05S-R25E
AMC 431379	Red Bull-207	2015-2262	SEC30-T05S-R25E
AMC 431380	Red Bull-208	2015-2263	SEC30-T05S-R25E
AMC 431381	Red Bull-209	2015-2264	SEC30-T05S-R25E
AMC 431382	Red Bull-210	2015-2265	SEC30-T05S-R25E
AMC 431383	Red Bull-211	2015-2266	SEC30-T05S-R25E
AMC 431384	Red Bull-212	2015-2267	SEC30-T05S-R25E
AMC 431385	Red Bull-213	2015-2268	SEC30-T05S-R25E
AMC 431386	Red Bull-214	2015-2269	SEC30-T05S-R25E
AMC 431387	Red Bull-215	2015-2270	SEC30-T05S-R25E
AMC 431388	Red Bull-216	2015-2271	SEC30-T05S-R25E
AMC 431389	Red Bull-217	2015-2272	SEC30-T05S-R25E
AMC 431390	Red Bull-218	2015-2273	SEC30-T05S-R25E
AMC 431391	Red Bull-219	2015-2274	SEC30-T05S-R25E

RECEIVED  
DLN AUSTIN OFFICE  
MAY 12 2015  
10:10:35  
3000 N. BRIDGES  
AUSTIN, TX 78701

EXHIBIT A

AMC 431392	Red Bull-220	2015-2275	SEC19-T05S-R25E
AMC 431393	Red Bull-221	2015-2276	SEC19-T05S-R25E
AMC 431394	Red Bull-222	2015-2277	SEC19-T05S-R25E
AMC 431395	Red Bull-223	2015-2278	SEC19-T05S-R25E
AMC 431396	Red Bull-224	2015-2279	SEC19-T05S-R25E
AMC 431397	Red Bull-225	2015-2280	SEC19-T05S-R25E
AMC 431398	Red Bull-226	2015-2281	SEC19-T05S-R25E
AMC 431399	Red Bull-227	2015-2282	SEC19-T05S-R25E
AMC 431400	Red Bull-228	2015-2283	SEC19-T05S-R25E
AMC 431401	Red Bull-229	2015-2284	SEC19-T05S-R25E
AMC 431402	Red Bull-230	2015-2285	SEC19-T05S-R25E
AMC 431403	Red Bull-231	2015-2286	SEC19-T05S-R25E
AMC 431404	Red Bull-232	2015-2287	SEC19-T05S-R25E
AMC 431405	Red Bull-233	2015-2288	SEC19-T05S-R25E
AMC 431406	Red Bull-234	2015-2289	SEC19-T05S-R25E
AMC 431407	Red Bull-235	2015-2290	SEC19-T05S-R25E
AMC 431408	Red Bull-236	2015-2291	SEC19-T05S-R25E
AMC 431409	Red Bull-237	2015-2292	SEC19-T05S-R25E
AMC 431410	Red Bull-238	2015-2293	SEC19-T05S-R25E
AMC 431411	Red Bull-239	2015-2294	SEC19-T05S-R25E
AMC 431412	Red Bull-240	2015-2295	SEC19-T05S-R25E
AMC 431413	Red Bull-241	2015-2296	SEC19-T05S-R25E
AMC 431414	Red Bull-242	2015-2297	SEC19-T05S-R25E
AMC 431415	Red Bull-243	2015-2298	SEC19-T05S-R25E
AMC 431416	Red Bull-244	2015-2299	SEC20-T05S-R25E
AMC 431417	Red Bull-245	2015-2300	SEC20-T05S-R25E
AMC 431418	Red Bull-246	2015-2301	SEC20-T05S-R25E
AMC 431419	Red Bull-247	2015-2302	SEC20-T05S-R25E
AMC 431420	Red Bull-248	2015-2303	SEC20-T05S-R25E
AMC 431421	Red Bull-249	2015-2304	SEC20-T05S-R25E
AMC 431422	Red Bull-250	2015-2305	SEC20-T05S-R25E
AMC 431423	Red Bull-251	2015-2306	SEC20-T05S-R25E
AMC 431424	Red Bull-252	2015-2307	SEC20-T05S-R25E
AMC 431425	Red Bull-253	2015-2308	SEC20-T05S-R25E
AMC 431426	Red Bull-254	2015-2309	SEC20-T05S-R25E
AMC 431427	Red Bull-255	2015-2310	SEC20-T05S-R25E
AMC 431428	Red Bull-256	2015-2311	SEC20-T05S-R25E
AMC 431429	Red Bull-257	2015-2312	SEC20-T05S-R25E
AMC 431430	Red Bull-258	2015-2313	SEC20-T05S-R25E
AMC 431431	Red Bull-259	2015-2314	SEC20-T05S-R25E
AMC 431432	Red Bull-260	2015-2315	SEC20-T05S-R25E
AMC 431433	Red Bull-261	2015-2316	SEC20-T05S-R25E
AMC 431434	Red Bull-262	2015-2317	SEC20-T05S-R25E
AMC 431435	Red Bull-263	2015-2318	SEC20-T05S-R25E
AMC 431436	Red Bull-264	2015-2319	SEC20-T05S-R25E
AMC 431437	Red Bull-265	2015-2320	SEC20-T05S-R25E
AMC 431438	Red Bull-266	2015-2321	SEC20-T05S-R25E

RECEIVED  
2019 APR 12 11:05 AM  
SEC20-T05S-R25E

EXHIBIT A

AMC 431439	Red Bull-267	2015-2322	SEC20-T05S-R25E
AMC 431440	Red Bull-268	2015-2323	SEC20-T05S-R25E
AMC 431441	Red Bull-269	2015-2324	SEC20-T05S-R25E
AMC 431442	Red Bull-270	2015-2325	SEC20-T05S-R25E
AMC 431443	Red Bull-271	2015-2326	SEC20-T05S-R25E
AMC 431444	Red Bull-272	2015-2327	SEC20-T05S-R25E
AMC 431445	Red Bull-273	2015-2328	SEC20-T05S-R25E
AMC 431446	Red Bull-274	2015-2329	SEC20-T05S-R25E
AMC 431447	Red Bull-275	2015-2330	SEC20-T05S-R25E
AMC 431448	Red Bull-276	2015-2331	SEC20-T05S-R25E
AMC 431449	Red Bull-277	2015-2332	SEC20-T05S-R25E
AMC 431450	Red Bull-278	2015-2333	SEC20-T05S-R25E
AMC 431451	Red Bull-279	2015-2334	SEC20-T05S-R25E
AMC 431452	Red Bull-280	2015-2335	SEC21-T05S-R25E
AMC 431453	Red Bull-281	2015-2336	SEC21-T05S-R25E
AMC 431454	Red Bull-282	2015-2337	SEC21-T05S-R25E
AMC 431455	Red Bull-283	2015-2338	SEC21-T05S-R25E
AMC 431456	Red Bull-284	2015-2339	SEC21-T05S-R25E
AMC 431457	Red Bull-285	2015-2340	SEC21-T05S-R25E
AMC 431458	Red Bull-286	2015-2341	SEC21-T05S-R25E
AMC 431459	Red Bull-287	2015-2342	SEC21-T05S-R25E
AMC 431460	Red Bull-288	2015-2343	SEC21-T05S-R25E
AMC 431461	Red Bull-289	2015-2344	SEC21-T05S-R25E
AMC 431462	Red Bull-290	2015-2345	SEC21-T05S-R25E
AMC 431463	Red Bull-291	2015-2346	SEC21-T05S-R25E
AMC 431464	Red Bull-292	2015-2347	SEC21-T05S-R25E
AMC 431465	Red Bull-293	2015-2348	SEC21-T05S-R25E
AMC 431466	Red Bull-294	2015-2349	SEC21-T05S-R25E
AMC 431467	Red Bull-295	2015-2350	SEC21-T05S-R25E
AMC 431468	Red Bull-296	2015-2351	SEC21-T05S-R25E
AMC 431469	Red Bull-297	2015-2352	SEC21-T05S-R25E
AMC 431470	Red Bull-298	2015-2353	SEC21-T05S-R25E
AMC 431471	Red Bull-299	2015-2354	SEC21-T05S-R25E
AMC 431472	Red Bull-300	2015-2355	SEC21-T05S-R25E
AMC 431473	Red Bull-301	2015-2356	SEC21-T05S-R25E
AMC 431474	Red Bull-302	2015-2357	SEC21-T05S-R25E
AMC 431475	Red Bull-303	2015-2358	SEC21-T05S-R25E
AMC 431476	Red Bull-304	2015-2359	SEC21-T05S-R25E
AMC 431477	Red Bull-305	2015-2360	SEC21-T05S-R25E
AMC 431478	Red Bull-306	2015-2361	SEC21-T05S-R25E
AMC 431479	Red Bull-307	2015-2362	SEC21-T05S-R25E
AMC 431480	Red Bull-308	2015-2363	SEC21-T05S-R25E
AMC 431481	Red Bull-309	2015-2364	SEC21-T05S-R25E
AMC 431482	Red Bull-310	2015-2365	SEC21-T05S-R25E
AMC 431483	Red Bull-311	2015-2366	SEC21-T05S-R25E
AMC 431484	Red Bull-312	2015-2367	SEC21-T05S-R25E
AMC 431485	Red Bull-313	2015-2368	SEC21-T05S-R25E

ARIZONA  
10 OCT 11 11:35  
OFFICE

EXHIBIT A

AMC 431486	Red Bull-314	2015-2369	SEC21-T05S-R25E
AMC 431487	Red Bull-315	2015-2370	SEC21-T05S-R25E
AMC 431488	Red Bull-379	2015-2130	SEC14-T05S-R25E
AMC 431489	Red Bull-380	2015-2131	SEC14-T05S-R25E
AMC 431490	Red Bull-381	2015-2132	SEC14-T05S-R25E
AMC 431491	Red Bull-382	2015-2133	SEC14-T05S-R25E
AMC 431492	Red Bull-383	2015-2134	SEC14-T05S-R25E
AMC 431493	Red Bull-384	2015-2135	SEC14-T05S-R25E
AMC 431494	Red Bull-385	2015-2136	SEC14-T05S-R25E
AMC 431495	Red Bull-386	2015-2137	SEC14-T05S-R25E
AMC 431496	Red Bull-387	2015-2138	SEC14-T05S-R25E
AMC 431497	Red Bull-388	2015-2139	SEC14-T05S-R25E
AMC 431498	Red Bull-389	2015-2140	SEC14-T05S-R25E
AMC 431499	Red Bull-390	2015-2141	SEC14-T05S-R25E
AMC 431500	Red Bull-391	2015-2142	SEC14-T05S-R25E
AMC 431501	Red Bull-392	2015-2143	SEC14-T05S-R25E
AMC 431502	Red Bull-393	2015-2144	SEC14-T05S-R25E
AMC 431503	Red Bull-394	2015-2145	SEC14-T05S-R25E
AMC 431504	Red Bull-395	2015-2146	SEC14-T05S-R25E
AMC 431505	Red Bull-396	2015-2147	SEC14-T05S-R25E
AMC 431542	Red Bull-469	2015-2184	SEC23-T05S-R25E
AMC 431543	Red Bull-470	2015-2185	SEC23-T05S-R25E
AMC 431544	Red Bull-471	2015-2186	SEC23-T05S-R25E
AMC 431545	Red Bull-472	2015-2187	SEC23-T05S-R25E
AMC 431546	Red Bull-473	2015-2188	SEC23-T05S-R25E
AMC 431547	Red Bull-474	2015-2189	SEC23-T05S-R25E
AMC 431548	Red Bull-475	2015-2190	SEC23-T05S-R25E
AMC 431549	Red Bull-476	2015-2191	SEC23-T05S-R25E
AMC 431550	Red Bull-477	2015-2192	SEC23-T05S-R25E
AMC 431551	Red Bull-478	2015-2193	SEC23-T05S-R25E
AMC 431552	Red Bull-479	2015-2194	SEC23-T05S-R25E
AMC 431553	Red Bull-480	2015-2195	SEC23-T05S-R25E
AMC 431554	Red Bull-481	2015-2196	SEC23-T05S-R25E
AMC 431555	Red Bull-482	2015-2197	SEC23-T05S-R25E
AMC 431556	Red Bull-483	2015-2198	SEC23-T05S-R25E
AMC 431557	Red Bull-484	2015-2199	SEC23-T05S-R25E
AMC 431566	ROCKSTAR 173	2015-2450	SEC36-T06S-R27E
AMC 431567	ROCKSTAR 174	2015-2451	SEC36-T06S-R27E
AMC 431568	ROCKSTAR 175	2015-2452	SEC36-T06S-R27E
AMC 431569	ROCKSTAR 176	2015-2453	SEC36-T06S-R27E
AMC 431570	ROCKSTAR 177	2015-2454	SEC36-T06S-R27E
AMC 431571	ROCKSTAR 178	2015-2455	SEC36-T06S-R27E
AMC 431572	ROCKSTAR 179	2015-2456	SEC35-T06S-R27E
AMC 431573	ROCKSTAR 180	2015-2457	SEC35-T06S-R27E
AMC 431574	ROCKSTAR 181	2015-2458	SEC35-T06S-R27E
AMC 431575	ROCKSTAR 182	2015-2459	SEC35-T06S-R27E
AMC 431576	ROCKSTAR 183	2015-2460	SEC35-T06S-R27E

RECEIVED  
 2017 SEP 12 12:35  
 AMX AM/100A

EXHIBIT A

AMC 431577	ROCKSTAR 184	2015-2461	SEC35-T06S-R27E
AMC 431578	ROCKSTAR 185	2015-2462	SEC35-T06S-R27E
AMC 431579	ROCKSTAR 186	2015-2463	SEC35-T06S-R27E
AMC 431580	ROCKSTAR 187	2015-2464	SEC35-T06S-R27E
AMC 431581	ROCKSTAR 188	2015-2465	SEC35-T06S-R27E
AMC 431582	ROCKSTAR 189	2015-2466	SEC35-T06S-R27E
AMC 431583	ROCKSTAR 190	2015-2467	SEC35-T06S-R27E
AMC 431584	ROCKSTAR 191	2015-2468	SEC35-T06S-R27E
AMC 431585	ROCKSTAR 192	2015-2469	SEC35-T06S-R27E
AMC 431586	ROCKSTAR 193	2015-2470	SEC35-T06S-R27E
AMC 431587	ROCKSTAR 194	2015-2471	SEC35-T06S-R27E
AMC 431588	ROCKSTAR 195	2015-2472	SEC35-T06S-R27E
AMC 431589	ROCKSTAR 196	2015-2473	SEC35-T06S-R27E
AMC 431590	ROCKSTAR 197	2015-2474	SEC34-T06S-R27E
AMC 431591	ROCKSTAR 198	2015-2475	SEC34-T06S-R27E
AMC 431592	ROCKSTAR 199	2015-2476	SEC34-T06S-R27E
AMC 431593	ROCKSTAR 200	2015-2477	SEC34-T06S-R27E
AMC 431594	ROCKSTAR 201	2015-2478	SEC34-T06S-R27E
AMC 431595	ROCKSTAR 202	2015-2479	SEC34-T06S-R27E
AMC 431596	ROCKSTAR 203	2015-2480	SEC34-T06S-R27E
AMC 431597	ROCKSTAR 204	2015-2481	SEC34-T06S-R27E
AMC 431598	ROCKSTAR 205	2015-2482	SEC34-T06S-R27E
AMC 431599	ROCKSTAR 206	2015-2483	SEC34-T06S-R27E
AMC 431600	ROCKSTAR 207	2015-2484	SEC34-T06S-R27E
AMC 431601	ROCKSTAR 208	2015-2485	SEC34-T06S-R27E
AMC 431602	ROCKSTAR 209	2015-2486	SEC35-T06S-R27E
AMC 431603	ROCKSTAR 210	2015-2487	SEC27-T06S-R27E
AMC 431611	ROCKSTAR 211	2015-2591	SEC04-T07S-R27E
AMC 431612	ROCKSTAR 212	2015-2592	SEC04-T07S-R27E
AMC 431613	ROCKSTAR 213	2015-2593	SEC04-T07S-R27E
AMC 431614	ROCKSTAR 214	2015-2594	SEC04-T07S-R27E
AMC 431615	ROCKSTAR 215	2015-2595	SEC04-T07S-R27E
AMC 431616	ROCKSTAR 216	2015-2596	SEC04-T07S-R27E
AMC 431617	ROCKSTAR 217	2015-2597	SEC04-T07S-R27E
AMC 431618	ROCKSTAR 218	2015-2598	SEC04-T07S-R27E
AMC 431619	ROCKSTAR 219	2015-2599	SEC04-T07S-R27E
AMC 431620	ROCKSTAR 220	2015-2600	SEC04-T07S-R27E
AMC 431621	ROCKSTAR 221	2015-2601	SEC04-T07S-R27E
AMC 431622	ROCKSTAR 222	2015-2602	SEC04-T07S-R27E
AMC 431623	ROCKSTAR 223	2015-2603	SEC04-T07S-R27E
AMC 431624	ROCKSTAR 224	2015-2604	SEC04-T07S-R27E
AMC 431625	ROCKSTAR 225	2015-2605	SEC04-T07S-R27E
AMC 431626	ROCKSTAR 226	2015-2606	SEC04-T07S-R27E
AMC 431627	ROCKSTAR 227	2015-2607	SEC04-T07S-R27E
AMC 431628	ROCKSTAR 228	2015-2608	SEC04-T07S-R27E
AMC 431629	ROCKSTAR 229	2015-2609	SEC04-T07S-R27E
AMC 431630	ROCKSTAR 230	2015-2610	SEC04-T07S-R27E

RECEIVED  
 2017 SEP 12  
 10:00 AM  
 EXHIBIT A  
 100

EXHIBIT A

AMC 431631	ROCKSTAR 231	2015-2611	SEC04-T07S-R27E
AMC 431632	ROCKSTAR 232	2015-2612	SEC04-T07S-R27E
AMC 431633	ROCKSTAR 233	2015-2613	SEC04-T07S-R27E
AMC 431634	ROCKSTAR 234	2015-2614	SEC04-T07S-R27E
AMC 431635	ROCKSTAR 235	2015-2615	SEC04-T07S-R27E
AMC 431636	ROCKSTAR 236	2015-2616	SEC04-T07S-R27E
AMC 431637	ROCKSTAR 237	2015-2617	SEC04-T07S-R27E
AMC 431638	ROCKSTAR 238	2015-2618	SEC04-T07S-R27E
AMC 431639	ROCKSTAR 239	2015-2619	SEC04-T07S-R27E
AMC 431640	ROCKSTAR 240	2015-2620	SEC04-T07S-R27E
AMC 431641	ROCKSTAR 241	2015-2621	SEC04-T07S-R27E
AMC 431642	ROCKSTAR 242	2015-2622	SEC04-T07S-R27E
AMC 431643	ROCKSTAR 243	2015-2623	SEC08-T07S-R27E
AMC 431644	ROCKSTAR 244	2015-2624	SEC08-T07S-R27E
AMC 431645	ROCKSTAR 245	2015-2625	SEC08-T07S-R27E
AMC 431646	ROCKSTAR 246	2015-2626	SEC08-T07S-R27E
AMC 431647	ROCKSTAR 247	2015-2627	SEC08-T07S-R27E
AMC 431648	ROCKSTAR 248	2015-2628	SEC08-T07S-R27E
AMC 431649	ROCKSTAR 249	2015-2629	SEC08-T07S-R27E
AMC 431650	ROCKSTAR 250	2015-2630	SEC08-T07S-R27E
AMC 431651	ROCKSTAR 251	2015-2631	SEC08-T07S-R27E
AMC 431652	ROCKSTAR 252	2015-2632	SEC08-T07S-R27E
AMC 431653	ROCKSTAR 253	2015-2633	SEC08-T07S-R27E
AMC 431654	ROCKSTAR 254	2015-2634	SEC08-T07S-R27E
AMC 431655	ROCKSTAR 255	2015-2635	SEC08-T07S-R27E
AMC 431656	ROCKSTAR 256	2015-2636	SEC08-T07S-R27E
AMC 431657	ROCKSTAR 257	2015-2637	SEC08-T07S-R27E
AMC 431658	ROCKSTAR 258	2015-2638	SEC08-T07S-R27E
AMC 431659	ROCKSTAR 259	2015-2639	SEC08-T07S-R27E
AMC 431660	ROCKSTAR 260	2015-2640	SEC08-T07S-R27E
AMC 431661	ROCKSTAR 261	2015-2641	SEC08-T07S-R27E
AMC 431662	ROCKSTAR 262	2015-2642	SEC08-T07S-R27E
AMC 431663	ROCKSTAR 263	2015-2643	SEC08-T07S-R27E
AMC 431664	ROCKSTAR 264	2015-2644	SEC08-T07S-R27E
AMC 431665	ROCKSTAR 265	2015-2645	SEC07-T07S-R27E
AMC 431666	ROCKSTAR 266	2015-2646	SEC07-T07S-R27E
AMC 431667	ROCKSTAR 267	2015-2647	SEC07-T07S-R27E
AMC 431668	ROCKSTAR 268	2015-2648	SEC07-T07S-R27E
AMC 431669	ROCKSTAR 269	2015-2649	SEC07-T07S-R27E
AMC 431671	ROCKSTAR 271	2015-2651	SEC07-T07S-R27E
AMC 431672	ROCKSTAR 272	2015-2652	SEC07-T07S-R27E
AMC 431673	ROCKSTAR 273	2015-2653	SEC07-T07S-R27E
AMC 431674	ROCKSTAR 274	2015-2654	SEC07-T07S-R27E
AMC 431675	ROCKSTAR 275	2015-2655	SEC07-T07S-R27E
AMC 431676	ROCKSTAR 276	2015-2656	SEC07-T07S-R27E
AMC 431677	ROCKSTAR 277	2015-2657	SEC07-T07S-R27E
AMC 431678	ROCKSTAR 278	2015-2658	SEC07-T07S-R27E

PHOTOGRAPHY  
MONTANA  
APR 12 2015  
12:35  
REC'D  
MONTANA  
APR 12 2015

EXHIBIT A

AMC 431679	ROCKSTAR 279	2015-2659	SEC07-T07S-R27E
AMC 431683	ROCKSTAR 283	2015-2663	SEC07-T07S-R27E
AMC 431791	MONSTER-224	2015-2808	SEC22-T05S-R27E
AMC 431792	MONSTER-225	2015-2809	SEC22-T05S-R27E
AMC 431793	MONSTER-226	2015-2810	SEC22-T05S-R27E
AMC 431794	MONSTER-227	2015-2811	SEC22-T05S-R27E
AMC 431795	MONSTER-228	2015-2812	SEC22-T05S-R27E
AMC 431796	MONSTER-229	2015-2813	SEC22-T05S-R27E
AMC 431797	MONSTER-230	2015-2814	SEC22-T05S-R27E
AMC 431798	MONSTER-231	2015-2815	SEC22-T05S-R27E
AMC 431799	MONSTER-232	2015-2816	SEC22-T05S-R27E
AMC 431800	MONSTER-233	2015-2817	SEC22-T05S-R27E
AMC 431801	MONSTER-234	2015-2818	SEC22-T05S-R27E
AMC 431802	MONSTER-235	2015-2819	SEC22-T05S-R27E
AMC 431803	MONSTER-236	2015-2820	SEC22-T05S-R27E
AMC 431804	MONSTER-237	2015-2821	SEC22-T05S-R27E
AMC 431805	MONSTER-238	2015-2822	SEC22-T05S-R27E
AMC 431806	MONSTER-239	2015-2823	SEC22-T05S-R27E
AMC 431807	MONSTER-240	2015-2824	SEC22-T05S-R27E
AMC 431808	MONSTER-241	2015-2825	SEC22-T05S-R27E
AMC 431809	MONSTER-242	2015-2826	SEC22-T05S-R27E
AMC 431810	MONSTER-243	2015-2827	SEC22-T05S-R27E
AMC 431811	MONSTER-244	2015-2828	SEC22-T05S-R27E
AMC 431812	MONSTER-245	2015-2829	SEC22-T05S-R27E
AMC 431813	MONSTER-246	2015-2830	SEC22-T05S-R27E
AMC 431814	MONSTER-247	2015-2831	SEC22-T05S-R27E
AMC 431815	MONSTER-248	2015-2832	SEC22-T05S-R27E
AMC 431816	MONSTER-249	2015-2833	SEC22-T05S-R27E
AMC 431817	MONSTER-250	2015-2834	SEC22-T05S-R27E
AMC 431818	MONSTER-251	2015-2835	SEC22-T05S-R27E
AMC 431819	MONSTER-252	2015-2836	SEC22-T05S-R27E
AMC 431820	MONSTER-253	2015-2837	SEC22-T05S-R27E
AMC 431821	MONSTER-254	2015-2838	SEC22-T05S-R27E
AMC 431822	MONSTER-255	2015-2839	SEC22-T05S-R27E
AMC 431823	MONSTER-256	2015-2840	SEC22-T05S-R27E
AMC 431824	MONSTER-257	2015-2841	SEC22-T05S-R27E
AMC 431825	MONSTER-258	2015-2842	SEC22-T05S-R27E
AMC 431826	MONSTER-259	2015-2843	SEC21-T05S-R27E
AMC 431827	MONSTER-260	2015-2844	SEC21-T05S-R27E
AMC 431828	MONSTER-261	2015-2845	SEC21-T05S-R27E
AMC 431829	MONSTER-262	2015-2846	SEC21-T05S-R27E
AMC 431830	MONSTER-263	2015-2847	SEC21-T05S-R27E
AMC 431831	MONSTER-264	2015-2848	SEC21-T05S-R27E
AMC 431832	MONSTER-265	2015-2849	SEC21-T05S-R27E
AMC 431833	MONSTER-266	2015-2850	SEC21-T05S-R27E
AMC 431834	MONSTER-267	2015-2851	SEC21-T05S-R27E
AMC 431835	MONSTER-268	2015-2852	SEC21-T05S-R27E

PHOENIX, ARIZONA  
 NOV 13 2015  
 11:30 AM  
 SEC21-T05S-R27E



EXHIBIT A

AMC 431836	MONSTER-269	2015-2853	SEC21-T05S-R27E
AMC 431837	MONSTER-270	2015-2854	SEC21-T05S-R27E
AMC 431838	MONSTER-271	2015-2855	SEC21-T05S-R27E
AMC 431839	MONSTER-272	2015-2856	SEC21-T05S-R27E
AMC 431840	MONSTER-277	2015-2857	SEC21-T05S-R27E
AMC 431841	MONSTER-278	2015-2858	SEC21-T05S-R27E
AMC 431842	MONSTER-279	2015-2859	SEC21-T05S-R27E
AMC 431843	MONSTER-280	2015-2860	SEC21-T05S-R27E
AMC 431844	MONSTER-285	2015-2861	SEC21-T05S-R27E
AMC 431845	MONSTER-286	2015-2862	SEC21-T05S-R27E
AMC 431846	MONSTER-287	2015-2863	SEC21-T05S-R27E
AMC 431847	MONSTER-288	2015-2864	SEC21-T05S-R27E
AMC 431848	MONSTER-293	2015-2865	SEC21-T05S-R27E
AMC 431849	MONSTER-294	2015-2866	SEC21-T05S-R27E
AMC 431850	MONSTER-421	2015-2867	SEC16-T05S-R27E
AMC 431851	MONSTER-422	2015-2868	SEC16-T05S-R27E
AMC 431852	MONSTER-423	2015-2869	SEC16-T05S-R27E
AMC 431853	MONSTER-424	2015-2870	SEC16-T05S-R27E
AMC 431854	MONSTER-425	2015-2871	SEC16-T05S-R27E
AMC 431855	MONSTER-426	2015-2872	SEC16-T05S-R27E
AMC 431856	MONSTER-427	2015-2873	SEC16-T05S-R27E
AMC 431857	MONSTER-428	2015-2874	SEC16-T05S-R27E
AMC 431858	MONSTER-429	2015-2875	SEC16-T05S-R27E
AMC 431859	MONSTER-430	2015-2876	SEC16-T05S-R27E
AMC 431860	MONSTER-431	2015-2877	SEC16-T05S-R27E
AMC 431861	MONSTER-432	2015-2878	SEC16-T05S-R27E
AMC 431862	MONSTER-433	2015-2879	SEC16-T05S-R27E
AMC 431863	MONSTER-434	2015-2880	SEC16-T05S-R27E
AMC 431864	MONSTER-435	2015-2881	SEC16-T05S-R27E
AMC 431865	MONSTER-436	2015-2882	SEC16-T05S-R27E
AMC 431866	MONSTER-437	2015-2883	SEC16-T05S-R27E
AMC 431867	MONSTER-438	2015-2884	SEC16-T05S-R27E
AMC 431868	MONSTER-439	2015-2885	SEC16-T05S-R27E
AMC 431869	MONSTER-440	2015-2886	SEC16-T05S-R27E
AMC 431870	MONSTER-441	2015-2887	SEC16-T05S-R27E
AMC 431871	MONSTER-442	2015-2888	SEC16-T05S-R27E
AMC 431872	MONSTER-443	2015-2889	SEC16-T05S-R27E
AMC 431873	MONSTER-444	2015-2890	SEC16-T05S-R27E
AMC 431874	MONSTER-445	2015-2891	SEC16-T05S-R27E
AMC 431875	MONSTER-446	2015-2892	SEC16-T05S-R27E
AMC 431876	MONSTER-447	2015-2893	SEC16-T05S-R27E
AMC 431877	MONSTER-448	2015-2894	SEC16-T05S-R27E
AMC 431878	MONSTER-449	2015-2895	SEC15-T05S-R27E
AMC 431879	MONSTER-450	2015-2896	SEC15-T05S-R27E
AMC 431880	MONSTER-451	2015-2897	SEC15-T05S-R27E
AMC 431881	MONSTER-452	2015-2898	SEC15-T05S-R27E
AMC 431882	MONSTER-453	2015-2899	SEC15-T05S-R27E

PHOENIX, ARIZONA  
 APR 19 10 55 AM '15  
 SEC15-T05S-R27E

EXHIBIT A

AMC 431883	MONSTER-454	2015-2900	SEC15-T05S-R27E
AMC 431884	MONSTER-455	2015-2901	SEC15-T05S-R27E
AMC 431885	MONSTER-456	2015-2902	SEC15-T05S-R27E
AMC 431886	MONSTER-457	2015-2903	SEC15-T05S-R27E
AMC 431887	MONSTER-458	2015-2904	SEC15-T05S-R27E
AMC 431888	MONSTER-459	2015-2905	SEC15-T05S-R27E
AMC 431889	MONSTER-460	2015-2906	SEC15-T05S-R27E
AMC 431890	MONSTER-461	2015-2907	SEC15-T05S-R27E
AMC 431891	MONSTER-462	2015-2908	SEC15-T05S-R27E
AMC 431892	MONSTER-463	2015-2909	SEC15-T05S-R27E
AMC 431893	MONSTER-464	2015-2910	SEC15-T05S-R27E
AMC 431894	MONSTER-465	2015-2911	SEC15-T05S-R27E
AMC 431895	MONSTER-466	2015-2912	SEC15-T05S-R27E
AMC 431896	MONSTER-467	2015-2913	SEC15-T05S-R27E
AMC 431897	MONSTER-468	2015-2914	SEC15-T05S-R27E
AMC 431898	MONSTER-469	2015-2915	SEC15-T05S-R27E
AMC 431899	MONSTER-470	2015-2916	SEC15-T05S-R27E
AMC 431900	MONSTER-471	2015-2917	SEC15-T05S-R27E
AMC 431901	MONSTER-472	2015-2918	SEC15-T05S-R27E
AMC 431902	MONSTER-473	2015-2919	SEC15-T05S-R27E
AMC 431903	MONSTER-474	2015-2920	SEC15-T05S-R27E
AMC 431904	MONSTER-109	2015-2664	SEC27-T05S-R27E
AMC 431905	MONSTER-110	2015-2665	SEC27-T05S-R27E
AMC 431906	MONSTER-111	2015-2666	SEC27-T05S-R27E
AMC 431907	MONSTER-112	2015-2667	SEC27-T05S-R27E
AMC 431908	MONSTER-113	2015-2668	SEC27-T05S-R27E
AMC 431909	MONSTER-114	2015-2669	SEC27-T05S-R27E
AMC 431910	MONSTER-115	2015-2670	SEC27-T05S-R27E
AMC 431911	MONSTER-116	2015-2671	SEC27-T05S-R27E
AMC 431912	MONSTER-117	2015-2672	SEC27-T05S-R27E
AMC 431913	MONSTER-118	2015-2673	SEC27-T05S-R27E
AMC 431914	MONSTER-119	2015-2674	SEC27-T05S-R27E
AMC 431915	MONSTER-120	2015-2675	SEC27-T05S-R27E
AMC 431916	MONSTER-121	2015-2676	SEC27-T05S-R27E
AMC 431917	MONSTER-122	2015-2677	SEC27-T05S-R27E
AMC 431918	MONSTER-123	2015-2678	SEC27-T05S-R27E
AMC 431919	MONSTER-124	2015-2679	SEC27-T05S-R27E
AMC 431920	MONSTER-125	2015-2680	SEC27-T05S-R27E
AMC 431921	MONSTER-126	2015-2681	SEC27-T05S-R27E
AMC 431922	MONSTER-127	2015-2682	SEC27-T05S-R27E
AMC 431923	MONSTER-128	2015-2683	SEC27-T05S-R27E
AMC 431924	MONSTER-129	2015-2684	SEC27-T05S-R27E
AMC 431925	MONSTER-130	2015-2685	SEC27-T05S-R27E
AMC 431926	MONSTER-131	2015-2686	SEC27-T05S-R27E
AMC 431927	MONSTER-132	2015-2687	SEC27-T05S-R27E
AMC 431928	MONSTER-133	2015-2688	SEC27-T05S-R27E
AMC 431929	MONSTER-134	2015-2689	SEC27-T05S-R27E

PHOENIX, ARIZONA

NOV 27 12 35

EXHIBIT A

AMC 431930	MONSTER-135	2015-2690		SEC27-T05S-R27E
AMC 431931	MONSTER-136	2015-2691		SEC27-T05S-R27E
AMC 431932	MONSTER-137	2015-2692		SEC27-T05S-R27E
AMC 431933	MONSTER-138	2015-2693		SEC27-T05S-R27E
AMC 431934	MONSTER-139	2015-2694		SEC27-T05S-R27E
AMC 431935	MONSTER-140	2015-2695		SEC27-T05S-R27E
AMC 431936	MONSTER-141	2015-2696		SEC34-T05S-R27E
AMC 431937	MONSTER-142	2015-2697		SEC34-T05S-R27E
AMC 431938	MONSTER-143	2015-2698		SEC34-T05S-R27E
AMC 431939	MONSTER-144	2015-2699		SEC34-T05S-R27E
AMC 431940	MONSTER-145	2015-2700		SEC34-T05S-R27E
AMC 431941	MONSTER-146	2015-2701		SEC34-T05S-R27E
AMC 431942	MONSTER-147	2015-2702	2016-04041	SEC34-T05S-R27E
AMC 431943	MONSTER-148	2015-2703	2016-04042	SEC34-T05S-R27E
AMC 431944	MONSTER-151	2015-2704	2016-04043	SEC34-T05S-R27E
AMC 431945	MONSTER-152	2015-2705	2016-04044	SEC34-T05S-R27E
AMC 431946	MONSTER-153	2015-2706		SEC34-T05S-R27E
AMC 431947	MONSTER-154	2015-2707		SEC34-T05S-R27E
AMC 431948	MONSTER-155	2015-2708		SEC34-T05S-R27E
AMC 431949	MONSTER-156	2015-2709		SEC34-T05S-R27E
AMC 431950	MONSTER-157	2015-2710		SEC34-T05S-R27E
AMC 431951	MONSTER-158	2015-2711		SEC34-T05S-R27E
AMC 431952	MONSTER-177	2015-2712		SEC35-T05S-R27E
AMC 431953	MONSTER-178	2015-2713		SEC35-T05S-R27E
AMC 431954	MONSTER-179	2015-2714		SEC35-T05S-R27E
AMC 431955	MONSTER-180	2015-2715		SEC35-T05S-R27E
AMC 431956	MONSTER-181	2015-2716		SEC35-T05S-R27E
AMC 431957	MONSTER-182	2015-2717		SEC35-T05S-R27E
AMC 431958	MONSTER-183	2015-2718		SEC35-T05S-R27E
AMC 431959	MONSTER-184	2015-2719		SEC35-T05S-R27E
AMC 431960	MONSTER-185	2015-2720		SEC35-T05S-R27E
AMC 431961	MONSTER-186	2015-2721		SEC35-T05S-R27E
AMC 431962	MONSTER-187	2015-2722		SEC35-T05S-R27E
AMC 431963	MONSTER-188	2015-2723		SEC35-T05S-R27E
AMC 431964	MONSTER-189	2015-2724		SEC35-T05S-R27E
AMC 431965	MONSTER-190	2015-2725		SEC35-T05S-R27E
AMC 431966	MONSTER-191	2015-2726		SEC35-T05S-R27E
AMC 431967	MONSTER-192	2015-2727		SEC35-T05S-R27E
AMC 431968	MONSTER-193	2015-2728		SEC35-T05S-R27E
AMC 431969	MONSTER-194	2015-2729		SEC35-T05S-R27E
AMC 431970	MONSTER-195	2015-2730		SEC35-T05S-R27E
AMC 431971	MONSTER-196	2015-2731		SEC35-T05S-R27E
AMC 431972	MONSTER-197	2015-2732		SEC35-T05S-R27E
AMC 431973	MONSTER-198	2015-2733		SEC35-T05S-R27E
AMC 431974	MONSTER-199	2015-2734		SEC35-T05S-R27E
AMC 431975	MONSTER-200	2015-2735		SEC35-T05S-R27E
AMC 431976	MONSTER-201	2015-2736		SEC35-T05S-R27E

RECEIVED  
 INZIGNA  
 2016 DEC 1 2 35  
 OFFICE

EXHIBIT A

AMC 431977	MONSTER-202	2015-2737	SEC26-T05S-R27E
AMC 431978	MONSTER-203	2015-2738	SEC26-T05S-R27E
AMC 431979	MONSTER-204	2015-2739	SEC26-T05S-R27E
AMC 431980	MONSTER-205	2015-2740	SEC26-T05S-R27E
AMC 431981	MONSTER-206	2015-2741	SEC26-T05S-R27E
AMC 431982	MONSTER-207	2015-2742	SEC26-T05S-R27E
AMC 431983	MONSTER-208	2015-2743	SEC26-T05S-R27E
AMC 431984	MONSTER-209	2015-2744	SEC26-T05S-R27E
AMC 431985	MONSTER-210	2015-2745	SEC26-T05S-R27E
AMC 431986	MONSTER-211	2015-2746	SEC26-T05S-R27E
AMC 431987	MONSTER-212	2015-2747	SEC26-T05S-R27E
AMC 431988	MONSTER-213	2015-2748	SEC26-T05S-R27E
AMC 431989	MONSTER-214	2015-2749	SEC26-T05S-R27E
AMC 431990	MONSTER-215	2015-2750	SEC26-T05S-R27E
AMC 431991	MONSTER-216	2015-2751	SEC26-T05S-R27E
AMC 431992	MONSTER-217	2015-2752	SEC26-T05S-R27E
AMC 431993	MONSTER-218	2015-2753	SEC26-T05S-R27E
AMC 431994	MONSTER-219	2015-2754	SEC23-T05S-R27E
AMC 431995	MONSTER-220	2015-2755	SEC23-T05S-R27E
AMC 431996	MONSTER-221	2015-2756	SEC23-T05S-R27E
AMC 431997	MONSTER-222	2015-2757	SEC23-T05S-R27E
AMC 431998	MONSTER-223	2015-2758	SEC23-T05S-R27E
AMC 431999	MONSTER-273	2015-2759	SEC21-T05S-R27E
AMC 432000	MONSTER-274	2015-2760	SEC21-T05S-R27E
AMC 432001	MONSTER-275	2015-2761	SEC21-T05S-R27E
AMC 432002	MONSTER-276	2015-2762	SEC21-T05S-R27E
AMC 432003	MONSTER-281	2015-2763	SEC21-T05S-R27E
AMC 432004	MONSTER-282	2015-2764	SEC21-T05S-R27E
AMC 432005	MONSTER-283	2015-2765	SEC21-T05S-R27E
AMC 432006	MONSTER-284	2015-2766	SEC21-T05S-R27E
AMC 432007	MONSTER-289	2015-2767	SEC21-T05S-R27E
AMC 432008	MONSTER-290	2015-2768	SEC21-T05S-R27E
AMC 432009	MONSTER-291	2015-2769	SEC21-T05S-R27E
AMC 432010	MONSTER-292	2015-2770	SEC21-T05S-R27E
AMC 432011	MONSTER-295	2015-2771	SEC20-T05S-R27E
AMC 432012	MONSTER-296	2015-2772	SEC20-T05S-R27E
AMC 432013	MONSTER-297	2015-2773	SEC20-T05S-R27E
AMC 432014	MONSTER-298	2015-2774	SEC20-T05S-R27E
AMC 432015	MONSTER-299	2015-2775	SEC20-T05S-R27E
AMC 432016	MONSTER-300	2015-2776	SEC20-T05S-R27E
AMC 432017	MONSTER-301	2015-2777	SEC20-T05S-R27E
AMC 432018	MONSTER-302	2015-2778	SEC20-T05S-R27E
AMC 432019	MONSTER-303	2015-2779	SEC20-T05S-R27E
AMC 432020	MONSTER-304	2015-2780	SEC20-T05S-R27E
AMC 432021	MONSTER-305	2015-2781	SEC20-T05S-R27E
AMC 432022	MONSTER-306	2015-2782	SEC20-T05S-R27E
AMC 432023	MONSTER-307	2015-2783	SEC20-T05S-R27E

ARIZONA  
SUPERIOR COURT  
CLERK  
JULY 2015

EXHIBIT A

AMC 432024	MONSTER-308	2015-2784	SEC20-T05S-R27E
AMC 432025	MONSTER-309	2015-2785	SEC20-T05S-R27E
AMC 432026	MONSTER-310	2015-2786	SEC20-T05S-R27E
AMC 432027	MONSTER-311	2015-2787	SEC20-T05S-R27E
AMC 432028	MONSTER-312	2015-2789	SEC20-T05S-R27E
AMC 432029	MONSTER-313	2015-2790	SEC20-T05S-R27E
AMC 432030	MONSTER-314	2015-2791	SEC20-T05S-R27E
AMC 432031	MONSTER-315	2015-2792	SEC20-T05S-R27E
AMC 432032	MONSTER-316	2015-2793	SEC20-T05S-R27E
AMC 432033	MONSTER-317	2015-2794	SEC20-T05S-R27E
AMC 432034	MONSTER-318	2015-2795	SEC20-T05S-R27E
AMC 432035	MONSTER-319	2015-2796	SEC20-T05S-R27E
AMC 432036	MONSTER-320	2015-2797	SEC20-T05S-R27E
AMC 432037	MONSTER-321	2015-2798	SEC20-T05S-R27E
AMC 432038	MONSTER-322	2015-2799	SEC20-T05S-R27E
AMC 432039	MONSTER-323	2015-2800	SEC20-T05S-R27E
AMC 432040	MONSTER-324	2015-2801	SEC20-T05S-R27E
AMC 432041	MONSTER-325	2015-2802	SEC20-T05S-R27E
AMC 432042	MONSTER-326	2015-2803	SEC20-T05S-R27E
AMC 432043	MONSTER-327	2015-2804	SEC20-T05S-R27E
AMC 432044	MONSTER-328	2015-2805	SEC20-T05S-R27E
AMC 432045	MONSTER-329	2015-2806	SEC20-T05S-R27E
AMC 432046	MONSTER-330	2015-2807	SEC20-T05S-R27E
AMC 432120	Red Bull-361	2015-3021	SEC14-T05S-R25E
AMC 432121	Red Bull-362	2015-3022	SEC14-T05S-R25E
AMC 432122	Red Bull-363	2015-3023	SEC14-T05S-R25E
AMC 432123	Red Bull-364	2015-3024	SEC14-T05S-R25E
AMC 432124	Red Bull-365	2015-3025	SEC14-T05S-R25E
AMC 432125	Red Bull-366	2015-3026	SEC14-T05S-R25E
AMC 432126	Red Bull-367	2015-3027	SEC14-T05S-R25E
AMC 432127	Red Bull-368	2015-3028	SEC14-T05S-R25E
AMC 432128	Red Bull-369	2015-3029	SEC14-T05S-R25E
AMC 432129	Red Bull-370	2015-3030	SEC14-T05S-R25E
AMC 432130	Red Bull-371	2015-3031	SEC14-T05S-R25E
AMC 432131	Red Bull-372	2015-3032	SEC14-T05S-R25E
AMC 432132	Red Bull-373	2015-3033	SEC14-T05S-R25E
AMC 432133	Red Bull-374	2015-3034	SEC14-T05S-R25E
AMC 432134	Red Bull-375	2015-3035	SEC14-T05S-R25E
AMC 432135	Red Bull-376	2015-3036	SEC14-T06S-R25E
AMC 432136	Red Bull-377	2015-3037	SEC14-T05S-R25E
AMC 432137	Red Bull-378	2015-3038	SEC14-T05S-R25E
AMC 432174	Red Bull-485	2015-3075	SEC25-T05S-R26E
AMC 432175	Red Bull-486	2015-3076	SEC25-T05S-R26E
AMC 432176	Red Bull-487	2015-3077	SEC25-T05S-R26E
AMC 432177	Red Bull-488	2015-3078	SEC25-T05S-R26E
AMC 432178	Red Bull-489	2015-3079	SEC25-T05S-R26E
AMC 432179	Red Bull-490	2015-3080	SEC25-T05S-R26E

PHOENIX, ARIZONA  
MILITARY DIVISION  
JAN 12 11:35 AM '09  
PHOENIX, ARIZONA

EXHIBIT A

AMC 432180	Red Bull-491	2015-3081	SEC25-T05S-R26E
AMC 432181	Red Bull-492	2015-3082	SEC25-T05S-R26E
AMC 432182	Red Bull-530	2015-3083	SEC13-T05S-R26E
AMC 432183	Red Bull-531	2015-3084	SEC13-T05S-R26E
AMC 432184	Red Bull-533	2015-3085	SEC13-T05S-R26E
AMC 432185	Red Bull-534	2015-3086	SEC13-T05S-R26E
AMC 432186	Red Bull-536	2015-3087	SEC13-T05S-R26E
AMC 432187	Red Bull-537	2015-3088	SEC13-T05S-R26E
AMC 432188	Red Bull-539	2015-3089	SEC13-T05S-R26E
AMC 432189	Red Bull-540	2015-3090	SEC13-T05S-R26E
AMC 432190	Red Bull-542	2015-3091	SEC13-T05S-R26E
AMC 432191	Red Bull-543	2015-3092	SEC13-T05S-R26E
AMC 432192	Red Bull-545	2015-3093	SEC13-T05S-R26E
AMC 432193	Red Bull-546	2015-3094	SEC13-T05S-R26E
AMC 432194	Red Bull-548	2015-3095	SEC13-T05S-R26E
AMC 432195	Red Bull-549	2015-3096	SEC13-T05S-R26E
AMC 432196	Red Bull-551	2015-3097	SEC13-T05S-R26E
AMC 432197	Red Bull-552	2015-3098	SEC13-T05S-R26E
AMC 432198	Red Bull-554	2015-3099	SEC13-T05S-R26E
AMC 432199	Red Bull-555	2015-3100	SEC12-T05S-R26E
AMC 432200	Red Bull-556	2015-3101	SEC12-T05S-R26E
AMC 432201	Red Bull-557	2015-3102	SEC12-T05S-R26E
AMC 432202	Red Bull-558	2015-3103	SEC12-T05S-R26E
AMC 432203	Red Bull-559	2015-3104	SEC12-T05S-R26E
AMC 432204	Red Bull-560	2015-3105	SEC12-T05S-R26E
AMC 432205	Red Bull-561	2015-3106	SEC12-T05S-R26E
AMC 432206	Red Bull-562	2015-3107	SEC12-T05S-R26E
AMC 432207	Red Bull-563	2015-3108	SEC12-T05S-R26E
AMC 432208	Red Bull-564	2015-3109	SEC12-T05S-R26E
AMC 432209	Red Bull-565	2015-3110	SEC12-T05S-R26E
AMC 432210	Red Bull-566	2015-3111	SEC12-T05S-R26E
AMC 432211	Red Bull-567	2015-3112	SEC12-T05S-R26E
AMC 432212	Red Bull-568	2015-3113	SEC12-T05S-R26E
AMC 432213	Red Bull-569	2015-3114	SEC12-T05S-R26E
AMC 432214	Red Bull-570	2015-3115	SEC12-T05S-R26E
AMC 432215	Red Bull-571	2015-3116	SEC12-T05S-R26E
AMC 432216	Red Bull-572	2015-3117	SEC12-T05S-R26E
AMC 432217	Red Bull-573	2015-3118	SEC12-T05S-R26E
AMC 432218	Red Bull-574	2015-3119	SEC12-T05S-R26E
AMC 432219	Red Bull-575	2015-3120	SEC12-T05S-R26E
AMC 432220	Red Bull-576	2015-3121	SEC12-T05S-R26E
AMC 432221	Red Bull-577	2015-3122	SEC12-T05S-R26E
AMC 432222	Red Bull-578	2015-3123	SEC12-T05S-R26E
AMC 432223	Red Bull-579	2015-3124	SEC12-T05S-R26E
AMC 432224	Red Bull-580	2015-3125	SEC12-T05S-R26E
AMC 432225	Red Bull-581	2015-3126	SEC12-T05S-R26E
AMC 432226	Red Bull-582	2015-3127	SEC12-T05S-R26E

AMERICAN  
 AIRLINES  
 INC.  
 1  
 2  
 3  
 4  
 5  
 6  
 7  
 8  
 9  
 10  
 11  
 12  
 13  
 14  
 15  
 16  
 17  
 18  
 19  
 20  
 21  
 22  
 23  
 24  
 25  
 26  
 27  
 28  
 29  
 30  
 31  
 32  
 33  
 34  
 35  
 36  
 37  
 38  
 39  
 40  
 41  
 42  
 43  
 44  
 45  
 46  
 47  
 48  
 49  
 50  
 51  
 52  
 53  
 54  
 55  
 56  
 57  
 58  
 59  
 60  
 61  
 62  
 63  
 64  
 65  
 66  
 67  
 68  
 69  
 70  
 71  
 72  
 73  
 74  
 75  
 76  
 77  
 78  
 79  
 80  
 81  
 82  
 83  
 84  
 85  
 86  
 87  
 88  
 89  
 90  
 91  
 92  
 93  
 94  
 95  
 96  
 97  
 98  
 99  
 100

EXHIBIT A

AMC 432227	Red Bull-583	2015-3128	SEC12-T05S-R26E
AMC 432228	Red Bull-584	2015-3129	SEC12-T05S-R26E
AMC 432229	Red Bull-585	2015-3130	SEC12-T05S-R26E
AMC 432230	Red Bull-586	2015-3131	SEC12-T05S-R26E
AMC 432231	Red Bull-587	2015-3132	SEC12-T05S-R26E
AMC 432232	Red Bull-588	2015-3133	SEC12-T05S-R26E
AMC 432233	Red Bull-589	2015-3134	SEC12-T05S-R26E
AMC 432234	Red Bull-590	2015-3135	SEC12-T05S-R26E
AMC 432235	Red Bull-591	2015-3136	SEC12-T05S-R26E
AMC 432241	MONSTER-367	2015-3138	SEC18-T05S-R27E
AMC 432242	MONSTER-368	2015-3139	SEC18-T05S-R27E
AMC 432243	MONSTER-369	2015-3140	SEC18-T05S-R27E
AMC 432244	MONSTER-370	2015-3141	SEC18-T05S-R27E
AMC 432245	MONSTER-371	2015-3142	SEC18-T05S-R27E
AMC 432246	MONSTER-372	2015-3143	SEC18-T05S-R27E
AMC 432247	MONSTER-373	2015-3144	SEC18-T05S-R27E
AMC 432248	MONSTER-374	2015-3145	SEC18-T05S-R27E
AMC 432249	MONSTER-375	2015-3146	SEC18-T05S-R27E
AMC 432250	MONSTER-376	2015-3147	SEC18-T05S-R27E
AMC 432251	MONSTER-377	2015-3148	SEC18-T05S-R27E
AMC 432252	MONSTER-378	2015-3149	SEC18-T05S-R27E
AMC 432253	MONSTER-379	2015-3150	SEC18-T05S-R27E
AMC 432254	MONSTER-380	2015-3151	SEC18-T05S-R27E
AMC 432255	MONSTER-381	2015-3152	SEC18-T05S-R27E
AMC 432256	MONSTER-382	2015-3153	SEC18-T05S-R27E
AMC 432257	MONSTER-383	2015-3154	SEC18-T05S-R27E
AMC 432258	MONSTER-384	2015-3155	SEC18-T05S-R27E
AMC 432259	MONSTER-385	2015-3156	SEC18-T05S-R27E
AMC 432260	MONSTER-386	2015-3157	SEC18-T05S-R27E
AMC 432261	MONSTER-387	2015-3158	SEC18-T05S-R27E
AMC 432262	MONSTER-388	2015-3159	SEC18-T05S-R27E
AMC 432263	MONSTER-389	2015-3160	SEC18-T05S-R27E
AMC 432264	MONSTER-390	2015-3161	SEC18-T05S-R27E
AMC 432265	MONSTER-391	2015-3162	SEC18-T05S-R27E
AMC 432266	MONSTER-392	2015-3163	SEC18-T05S-R27E
AMC 432267	MONSTER-393	2015-3164	SEC18-T05S-R27E
AMC 432268	MONSTER-394	2015-3165	SEC17-T05S-R27E
AMC 432269	MONSTER-395	2015-3166	SEC17-T05S-R27E
AMC 432270	MONSTER-396	2015-3167	SEC17-T05S-R27E
AMC 432271	MONSTER-397	2015-3168	SEC17-T05S-R27E
AMC 432272	MONSTER-398	2015-3169	SEC17-T05S-R27E
AMC 432273	MONSTER-399	2015-3170	SEC17-T05S-R27E
AMC 432274	MONSTER-400	2015-3171	SEC17-T05S-R27E
AMC 432275	MONSTER-401	2015-3172	SEC17-T05S-R27E
AMC 432276	MONSTER-402	2015-3173	SEC17-T05S-R27E
AMC 432277	MONSTER-403	2015-3174	SEC17-T05S-R27E
AMC 432278	MONSTER-404	2015-3175	SEC17-T05S-R27E

RECEIVED  
 11:35  
 11/10/12

EXHIBIT A

AMC 432279	MONSTER-405	2015-3176	SEC17-T05S-R27E
AMC 432280	MONSTER-406	2015-3177	SEC17-T05S-R27E
AMC 432281	MONSTER-407	2015-3178	SEC17-T05S-R27E
AMC 432282	MONSTER-408	2015-3179	SEC17-T05S-R27E
AMC 432283	MONSTER-409	2015-3180	SEC17-T05S-R27E
AMC 432284	MONSTER-410	2015-3181	SEC17-T05S-R27E
AMC 432285	MONSTER-411	2015-3182	SEC17-T05S-R27E
AMC 432286	MONSTER-412	2015-3183	SEC17-T05S-R27E
AMC 432287	MONSTER-413	2015-3184	SEC17-T05S-R27E
AMC 432288	MONSTER-414	2015-3185	SEC17-T05S-R27E
AMC 432289	MONSTER-415	2015-3186	SEC17-T05S-R27E
AMC 432290	MONSTER-416	2015-3187	SEC17-T05S-R27E
AMC 432291	MONSTER-417	2015-3188	SEC17-T05S-R27E
AMC 432292	MONSTER-418	2015-3189	SEC17-T05S-R27E
AMC 432293	MONSTER-419	2015-3190	SEC17-T05S-R27E
AMC 432294	MONSTER-420	2015-3191	SEC17-T05S-R27E
AMC 432295	MONSTER-475	2015-3182	SEC10-T05S-R27E
AMC 432296	MONSTER-476	2015-3183	SEC10-T05S-R27E
AMC 432297	MONSTER-477	2015-3184	SEC10-T05S-R27E
AMC 432298	MONSTER-478	2015-3185	SEC10-T05S-R27E
AMC 432299	MONSTER-479	2015-3186	SEC10-T05S-R27E
AMC 432300	MONSTER-480	2015-3187	SEC10-T05S-R27E
AMC 432301	MONSTER-481	2015-3188	SEC10-T05S-R27E
AMC 432302	MONSTER-482	2015-3189	SEC10-T05S-R27E
AMC 432303	MONSTER-483	2015-3190	SEC09-T05S-R27E
AMC 432304	MONSTER-484	2015-3191	SEC09-T05S-R27E
AMC 432305	MONSTER-485	2015-3192	SEC09-T05S-R27E
AMC 432306	MONSTER-486	2015-3193	SEC09-T05S-R27E
AMC 432307	MONSTER-487	2015-3194	SEC09-T05S-R27E
AMC 432308	MONSTER-488	2015-3195	SEC09-T05S-R27E
AMC 432309	MONSTER-489	2015-3196	SEC09-T05S-R27E
AMC 432310	MONSTER-490	2015-3197	SEC09-T05S-R27E
AMC 432311	MONSTER-491	2015-3198	SEC09-T05S-R27E
AMC 432312	MONSTER-492	2015-3199	SEC09-T05S-R27E
AMC 432313	MONSTER-493	2015-3200	SEC09-T05S-R27E
AMC 432314	MONSTER-494	2015-3201	SEC09-T05S-R27E
AMC 432315	MONSTER-495	2015-3202	SEC09-T05S-R27E
AMC 432316	MONSTER-496	2015-3203	SEC09-T05S-R27E
AMC 432317	MONSTER-497	2015-3204	SEC09-T05S-R27E
AMC 432318	MONSTER-498	2015-3205	SEC09-T05S-R27E
AMC 432319	MONSTER-499	2015-3206	SEC09-T05S-R27E
AMC 432320	MONSTER-500	2015-3207	SEC09-T05S-R27E
AMC 432321	MONSTER-501	2015-3208	SEC09-T05S-R27E
AMC 432322	MONSTER-502	2015-3209	SEC09-T05S-R27E
AMC 432323	MONSTER-503	2015-3210	SEC09-T05S-R27E
AMC 432324	MONSTER-504	2015-3211	SEC09-T05S-R27E
AMC 432325	MONSTER-505	2015-3212	SEC09-T05S-R27E

2017  
 JUL 13 10 13 AM  
 HOENIX, ARIZONA  
 135



EXHIBIT A

AMC 432326	MONSTER-506	2015-3213	SEC09-T05S-R27E
AMC 432327	MONSTER-507	2015-3214	SEC09-T05S-R27E
AMC 432328	MONSTER-508	2015-3215	SEC09-T05S-R27E
AMC 432329	MONSTER-509	2015-3216	SEC09-T05S-R27E
AMC 432330	MONSTER-510	2015-3217	SEC08-T05S-R27E
AMC 432331	MONSTER-511	2015-3218	SEC08-T05S-R27E
AMC 432332	MONSTER-512	2015-3219	SEC08-T05S-R27E
AMC 432333	MONSTER-513	2015-3220	SEC08-T05S-R27E
AMC 432334	MONSTER-514	2015-3221	SEC08-T05S-R27E
AMC 432335	MONSTER-515	2015-3222	SEC08-T05S-R27E
AMC 432336	MONSTER-516	2015-3223	SEC08-T05S-R27E
AMC 432337	MONSTER-517	2015-3224	SEC08-T05S-R27E
AMC 432338	MONSTER-518	2015-3225	SEC08-T05S-R27E
AMC 432339	MONSTER-519	2015-3226	SEC08-T05S-R27E
AMC 432340	MONSTER-520	2015-3227	SEC08-T05S-R27E
AMC 432341	MONSTER-521	2015-3228	SEC08-T05S-R27E
AMC 432342	MONSTER-522	2015-3229	SEC08-T05S-R27E
AMC 432343	MONSTER-523	2015-3230	SEC08-T05S-R27E
AMC 432344	MONSTER-524	2015-3231	SEC08-T05S-R27E
AMC 432345	MONSTER-525	2015-3232	SEC08-T05S-R27E
AMC 432346	MONSTER-526	2015-3233	SEC08-T05S-R27E
AMC 432347	MONSTER-527	2015-3234	SEC08-T05S-R27E
AMC 432348	MONSTER-528	2015-3235	SEC08-T05S-R27E
AMC 432349	MONSTER-529	2015-3236	SEC08-T05S-R27E
AMC 432350	MONSTER-530	2015-3237	SEC08-T05S-R27E
AMC 432351	MONSTER-531	2015-3238	SEC08-T05S-R27E
AMC 432352	MONSTER-532	2015-3239	SEC08-T05S-R27E
AMC 432353	MONSTER-533	2015-3240	SEC08-T05S-R27E
AMC 432354	MONSTER-534	2015-3241	SEC08-T05S-R27E
AMC 432355	MONSTER-535	2015-3242	SEC08-T05S-R27E
AMC 432356	MONSTER-536	2015-3243	SEC08-T05S-R27E
AMC 432357	MONSTER-537	2015-3244	SEC07-T05S-R27E
AMC 432358	MONSTER-538	2015-3245	SEC07-T05S-R27E
AMC 432359	MONSTER-539	2015-3246	SEC07-T05S-R27E
AMC 432360	MONSTER-540	2015-3247	SEC07-T05S-R27E
AMC 432361	MONSTER-541	2015-3248	SEC07-T05S-R27E
AMC 432362	MONSTER-542	2015-3249	SEC07-T05S-R27E
AMC 432363	MONSTER-543	2015-3250	SEC07-T05S-R27E
AMC 432364	MONSTER-544	2015-3251	SEC07-T05S-R27E
AMC 432365	MONSTER-545	2015-3252	SEC07-T05S-R27E
AMC 432366	MONSTER-546	2015-3253	SEC07-T05S-R27E
AMC 432367	MONSTER-547	2015-3254	SEC07-T05S-R27E
AMC 432368	MONSTER-548	2015-3255	SEC07-T05S-R27E
AMC 432369	MONSTER-549	2015-3256	SEC07-T05S-R27E
AMC 432370	MONSTER-550	2015-3257	SEC07-T05S-R27E
AMC 432371	MONSTER-551	2015-3258	SEC07-T05S-R27E
AMC 432372	MONSTER-552	2015-3259	SEC07-T05S-R27E

ARIZONA  
HIGHWAY  
DEPARTMENT  
OFFICE  
7:36

EXHIBIT A

AMC 432373	MONSTER-553	2015-3260	SEC07-T05S-R27E
AMC 432374	MONSTER-554	2015-3261	SEC07-T05S-R27E
AMC 432375	MONSTER-555	2015-3262	SEC07-T05S-R27E
AMC 432376	MONSTER-556	2015-3263	SEC07-T05S-R27E
AMC 432377	MONSTER-557	2015-3264	SEC07-T05S-R27E
AMC 432378	MONSTER-558	2015-3265	SEC07-T05S-R27E
AMC 432379	MONSTER-559	2015-3266	SEC07-T05S-R27E
AMC 432380	MONSTER-560	2015-3267	SEC07-T05S-R27E
AMC 432381	MONSTER-561	2015-3268	SEC07-T05S-R27E
AMC 432382	MONSTER-562	2015-3269	SEC07-T05S-R27E
AMC 432383	MONSTER-563	2015-3270	SEC07-T05S-R27E
AMC 432384	MONSTER-589	2015-3281	SEC08-T05S-R27E
AMC 432385	MONSTER-590	2015-3282	SEC05-T05S-R27E
AMC 432386	MONSTER-591	2015-3283	SEC04-T05S-R27E
AMC 432387	MONSTER-592	2015-3284	SEC04-T05S-R27E
AMC 432388	MONSTER-593	2015-3285	SEC04-T05S-R27E
AMC 432389	MONSTER-594	2015-3286	SEC04-T05S-R27E
AMC 432390	MONSTER-595	2015-3287	SEC04-T05S-R27E
AMC 432391	MONSTER-596	2015-3288	SEC04-T05S-R27E
AMC 432392	MONSTER-597	2015-3289	SEC04-T05S-R27E
AMC 432393	MONSTER-598	2015-3290	SEC04-T05S-R27E
AMC 432394	MONSTER-599	2015-3291	SEC04-T05S-R27E
AMC 432395	MONSTER-600	2015-3292	SEC04-T05S-R27E
AMC 432396	MONSTER-601	2015-3293	SEC04-T05S-R27E
AMC 432397	MONSTER-602	2015-3294	SEC04-T05S-R27E
AMC 432398	MONSTER-603	2015-3295	SEC04-T05S-R27E
AMC 432399	MONSTER-604	2015-3296	SEC04-T05S-R27E
AMC 432400	MONSTER-605	2015-3297	SEC04-T05S-R27E
AMC 432401	MONSTER-606	2015-3298	SEC04-T05S-R27E
AMC 432402	MONSTER-607	2015-3299	SEC04-T05S-R27E
AMC 432403	MONSTER-608	2015-3300	SEC04-T05S-R27E
AMC 432404	MONSTER-609	2015-3301	SEC04-T05S-R27E
AMC 432405	MONSTER-610	2015-3302	SEC04-T05S-R27E
AMC 432406	MONSTER-611	2015-3303	SEC04-T05S-R27E
AMC 432407	MONSTER-612	2015-3304	SEC04-T05S-R27E
AMC 432408	MONSTER-613	2015-3305	SEC04-T05S-R27E
AMC 432409	MONSTER-614	2015-3306	SEC04-T05S-R27E
AMC 432410	MONSTER-615	2015-3307	SEC04-T05S-R27E
AMC 432411	MONSTER-616	2015-3308	SEC04-T05S-R27E
AMC 432412	MONSTER-617	2015-3309	SEC04-T05S-R27E
AMC 432413	MONSTER-618	2015-3310	SEC04-T05S-R27E
AMC 432414	MONSTER-619	2015-3311	SEC04-T05S-R27E
AMC 432415	MONSTER-620	2015-3312	SEC04-T05S-R27E
AMC 432416	MONSTER-621	2015-3313	SEC04-T05S-R27E
AMC 432417	MONSTER-622	2015-3314	SEC04-T05S-R27E
AMC 432443	MONSTER-564	2015-3476	SEC06-T05S-R27E
AMC 432444	MONSTER-565	2015-3477	SEC06-T05S-R27E

PHOENIX, ARIZONA  
NOV 21 11:36 AM  
FBI

EXHIBIT A

AMC 432445	MONSTER-566	2015-3478	SEC06-T05S-R27E
AMC 432446	MONSTER-567	2015-3479	SEC06-T05S-R27E
AMC 432447	MONSTER-568	2015-3480	SEC06-T05S-R27E
AMC 432448	MONSTER-569	2015-3481	SEC06-T05S-R27E
AMC 432449	MONSTER-570	2015-3482	SEC06-T05S-R27E
AMC 432450	MONSTER-571	2015-3483	SEC06-T05S-R27E
AMC 432451	MONSTER-572	2015-3484	SEC06-T05S-R27E
AMC 432452	MONSTER-573	2015-3485	SEC06-T05S-R27E
AMC 432453	MONSTER-574	2015-3486	SEC06-T05S-R27E
AMC 432454	MONSTER-575	2015-3487	SEC06-T05S-R27E
AMC 432455	MONSTER-576	2015-3488	SEC06-T05S-R27E
AMC 432456	MONSTER-577	2015-3489	SEC06-T05S-R27E
AMC 432457	MONSTER-578	2015-3490	SEC06-T05S-R27E
AMC 432458	MONSTER-579	2015-3491	SEC06-T05S-R27E
AMC 432459	MONSTER-580	2015-3492	SEC06-T05S-R27E
AMC 432460	MONSTER-581	2015-3493	SEC06-T05S-R27E
AMC 432461	MONSTER-582	2015-3494	SEC06-T05S-R27E
AMC 432462	MONSTER-583	2015-3495	SEC06-T05S-R27E
AMC 432463	MONSTER-584	2015-3496	SEC05-T05S-R27E
AMC 432464	MONSTER-585	2015-3497	SEC05-T05S-R27E
AMC 432465	MONSTER-586	2015-3498	SEC08-T05S-R27E
AMC 432466	MONSTER-587	2015-3499	SEC08-T05S-R27E
AMC 432467	MONSTER-588	2015-3500	SEC08-T05S-R27E
AMC 432486	Red Bull-493	2015-3656	SEC24-T05S-R26E
AMC 432487	Red Bull-494	2015-3657	SEC24-T05S-R26E
AMC 432488	Red Bull-495	2015-3658	SEC24-T05S-R26E
AMC 432489	Red Bull-496	2015-3659	SEC24-T05S-R26E
AMC 432490	Red Bull-497	2015-3660	SEC24-T05S-R26E
AMC 432491	Red Bull-498	2015-3661	SEC24-T05S-R26E
AMC 432492	Red Bull-499	2015-3662	SEC24-T05S-R26E
AMC 432493	Red Bull-500	2015-3663	SEC24-T05S-R26E
AMC 432494	Red Bull-501	2015-3664	SEC24-T05S-R26E
AMC 432495	Red Bull-502	2015-3665	SEC24-T05S-R26E
AMC 432496	Red Bull-503	2015-3666	SEC24-T05S-R26E
AMC 432497	Red Bull-504	2015-3667	SEC24-T05S-R26E
AMC 432498	Red Bull-505	2015-3668	SEC24-T05S-R26E
AMC 432499	Red Bull-506	2015-3669	SEC24-T05S-R26E
AMC 432500	Red Bull-507	2015-3670	SEC24-T05S-R26E
AMC 432501	Red Bull-508	2015-3671	SEC24-T05S-R26E
AMC 432502	Red Bull-509	2015-3672	SEC24-T05S-R26E
AMC 432503	Red Bull-510	2015-3673	SEC24-T05S-R26E
AMC 432504	Red Bull-511	2015-3674	SEC24-T05S-R26E
AMC 432505	Red Bull-512	2015-3675	SEC24-T05S-R26E
AMC 432506	Red Bull-513	2015-3676	SEC24-T05S-R26E
AMC 432507	Red Bull-514	2015-3677	SEC24-T05S-R26E
AMC 432508	Red Bull-515	2015-3678	SEC24-T05S-R26E
AMC 432509	Red Bull-516	2015-3679	SEC24-T05S-R26E

RECEIVED  
 OCT 25 11:36  
 FBI  
 HOUSTON, TEXAS

EXHIBIT A

AMC 432510	Red Bull-517	2015-3680	SEC24-T05S-R26E
AMC 432511	Red Bull-518	2015-3681	SEC24-T05S-R26E
AMC 432512	Red Bull-519	2015-3682	SEC24-T05S-R26E
AMC 432513	Red Bull-520	2015-3683	SEC24-T05S-R26E
AMC 432514	Red Bull-521	2015-3684	SEC24-T05S-R26E
AMC 432515	Red Bull-522	2015-3685	SEC24-T05S-R26E
AMC 432516	Red Bull-523	2015-3686	SEC24-T05S-R26E
AMC 432517	Red Bull-524	2015-3687	SEC24-T05S-R26E
AMC 432518	Red Bull-525	2015-3688	SEC24-T05S-R26E
AMC 432519	Red Bull-526	2015-3689	SEC24-T05S-R26E
AMC 432520	Red Bull-527	2015-3690	SEC24-T05S-R26E
AMC 432521	Red Bull-528	2015-3691	SEC24-T05S-R26E
AMC 432522	Red Bull-529	2015-3692	SEC13-T05S-R26E
AMC 432523	Red Bull-532	2015-3693	SEC13-T05S-R26E
AMC 432524	Red Bull-535	2015-3694	SEC13-T05S-R26E
AMC 432525	Red Bull-538	2015-3695	SEC13-T05S-R26E
AMC 432526	Red Bull-541	2015-3696	SEC13-T05S-R26E
AMC 432527	Red Bull-544	2015-3697	SEC13-T05S-R26E
AMC 432528	Red Bull-547	2015-3698	SEC13-T05S-R26E
AMC 432529	Red Bull-550	2015-3699	SEC13-T05S-R26E
AMC 432530	Red Bull-553	2015-3700	SEC13-T05S-R26E
AMC 432531	Red Bull-592	2015-3701	SEC01-T05S-R26E
AMC 432532	Red Bull-593	2015-3702	SEC01-T05S-R26E
AMC 432533	Red Bull-594	2015-3703	SEC01-T05S-R26E
AMC 432534	Red Bull-595	2015-3704	SEC01-T05S-R26E
AMC 432535	Red Bull-596	2015-3705	SEC01-T05S-R26E
AMC 432536	Red Bull-597	2015-3706	SEC01-T05S-R26E
AMC 432537	Red Bull-598	2015-3707	SEC01-T05S-R26E
AMC 432538	Red Bull-599	2015-3708	SEC01-T05S-R26E
AMC 432539	Red Bull-600	2015-3709	SEC01-T05S-R26E
AMC 432540	Red Bull-601	2015-3710	SEC01-T05S-R26E
AMC 432541	Red Bull-602	2015-3711	SEC01-T05S-R26E
AMC 432542	Red Bull-603	2015-3712	SEC01-T05S-R26E
AMC 432543	Red Bull-604	2015-3713	SEC01-T05S-R26E
AMC 432544	Red Bull-605	2015-3714	SEC23-T05S-R26E
AMC 432545	Red Bull-606	2015-3715	SEC23-T05S-R26E
AMC 432546	Red Bull-607	2015-3716	SEC23-T05S-R26E
AMC 432547	Red Bull-608	2015-3717	SEC23-T05S-R26E
AMC 432548	Red Bull-609	2015-3718	SEC23-T05S-R26E
AMC 432549	Red Bull-610	2015-3719	SEC23-T05S-R26E
AMC 432550	Red Bull-611	2015-3720	SEC23-T05S-R26E
AMC 432551	Red Bull-612	2015-3721	SEC23-T05S-R26E
AMC 432552	Red Bull-613	2015-3722	SEC14-T05S-R26E
AMC 432553	Red Bull-614	2015-3723	SEC14-T05S-R26E
AMC 432554	Red Bull-615	2015-3724	SEC14-T05S-R26E
AMC 432555	Red Bull-616	2015-3725	SEC14-T05S-R26E
AMC 432556	Red Bull-617	2015-3726	SEC14-T05S-R26E

RECEIVED  
TARRANT COUNTY  
CLERK'S OFFICE  
SAN ANTONIO, TEXAS  
JAN 11 2016 1:36  
ARIZONA

EXHIBIT A

AMC 432557	Red Bull-618	2015-3727	SEC14-T05S-R26E
AMC 432558	Red Bull-619	2015-3728	SEC14-T05S-R26E
AMC 432559	Red Bull-620	2015-3729	SEC14-T05S-R26E
AMC 432560	Red Bull-621	2015-3730	SEC14-T05S-R26E
AMC 432561	Red Bull-622	2015-3731	SEC14-T05S-R26E
AMC 432562	Red Bull-623	2015-3732	SEC14-T05S-R26E
AMC 432563	Red Bull-624	2015-3733	SEC14-T05S-R26E
AMC 432564	Red Bull-625	2015-3734	SEC14-T05S-R26E
AMC 432565	Red Bull-626	2015-3735	SEC14-T05S-R26E
AMC 432566	Red Bull-627	2015-3736	SEC14-T05S-R26E
AMC 432567	Red Bull-628	2015-3737	SEC14-T05S-R26E
AMC 432568	Red Bull-629	2015-3738	SEC14-T05S-R26E
AMC 432569	Red Bull-630	2015-3739	SEC14-T05S-R26E
AMC 432570	Red Bull-631	2015-3740	SEC14-T05S-R26E
AMC 432571	Red Bull-632	2015-3741	SEC14-T05S-R26E
AMC 432572	Red Bull-633	2015-3742	SEC14-T05S-R26E
AMC 432573	Red Bull-634	2015-3743	SEC14-T05S-R26E
AMC 432574	Red Bull-635	2015-3744	SEC14-T05S-R26E
AMC 432575	Red Bull-636	2015-3745	SEC14-T05S-R26E
AMC 432576	Red Bull-637	2015-3746	SEC14-T05S-R26E
AMC 432577	Red Bull-638	2015-3747	SEC14-T05S-R26E
AMC 432578	Red Bull-639	2015-3748	SEC14-T05S-R26E
AMC 432579	Red Bull-640	2015-3749	SEC14-T05S-R26E
AMC 432580	Red Bull-641	2015-3750	SEC11-T05S-R26E
AMC 432581	Red Bull-642	2015-3751	SEC11-T05S-R26E
AMC 432582	Red Bull-643	2015-3752	SEC11-T05S-R26E
AMC 432583	Red Bull-644	2015-3753	SEC11-T05S-R26E
AMC 432584	Red Bull-645	2015-3754	SEC11-T05S-R26E
AMC 432585	Red Bull-646	2015-3755	SEC11-T05S-R26E
AMC 432586	Red Bull-647	2015-3756	SEC11-T05S-R26E
AMC 432587	Red Bull-648	2015-3757	SEC11-T05S-R26E
AMC 432588	Red Bull-649	2015-3758	SEC11-T05S-R26E
AMC 432589	Red Bull-650	2015-3759	SEC11-T05S-R26E
AMC 432590	Red Bull-651	2015-3760	SEC11-T05S-R26E
AMC 432591	Red Bull-652	2015-3761	SEC11-T05S-R26E
AMC 432592	Red Bull-653	2015-3762	SEC11-T05S-R26E
AMC 432593	Red Bull-654	2015-3763	SEC11-T05S-R26E
AMC 432594	Red Bull-655	2015-3764	SEC11-T05S-R26E
AMC 432595	Red Bull-656	2015-3765	SEC11-T05S-R26E
AMC 432596	Red Bull-657	2015-3766	SEC11-T05S-R26E
AMC 432597	Red Bull-658	2015-3767	SEC11-T05S-R26E
AMC 432598	Red Bull-659	2015-3768	SEC11-T05S-R26E
AMC 432599	Red Bull-660	2015-3769	SEC11-T05S-R26E
AMC 432600	Red Bull-661	2015-3770	SEC11-T05S-R26E
AMC 432601	Red Bull-662	2015-3771	SEC11-T05S-R26E
AMC 432602	Red Bull-663	2015-3772	SEC11-T05S-R26E
AMC 432603	Red Bull-664	2015-3773	SEC11-T05S-R26E

RECEIVED  
12 FEB 13 11 36 AM  
FBI - DENVER

EXHIBIT A

AMC 432604	Red Bull-665	2015-3774	SEC11-T05S-R26E
AMC 432605	Red Bull-666	2015-3775	SEC11-T05S-R26E
AMC 432606	Red Bull-667	2015-3776	SEC11-T05S-R26E
AMC 432607	Red Bull-668	2015-3777	SEC11-T05S-R26E
AMC 432608	Red Bull-669	2015-3778	SEC11-T05S-R26E
AMC 432609	Red Bull-670	2015-3779	SEC11-T05S-R26E
AMC 432610	Red Bull-671	2015-3780	SEC11-T05S-R26E
AMC 432611	Red Bull-672	2015-3781	SEC11-T05S-R26E
AMC 432612	Red Bull-673	2015-3782	SEC11-T05S-R26E
AMC 432613	Red Bull-674	2015-3783	SEC11-T05S-R26E
AMC 432614	Red Bull-675	2015-3784	SEC11-T05S-R26E
AMC 432615	Red Bull-676	2015-3785	SEC11-T05S-R26E
AMC 432616	Red Bull-677	2015-3786	SEC11-T05S-R26E
AMC 432617	Red Bull-678	2015-3787	SEC11-T05S-R26E
AMC 432618	Red Bull-679	2015-3788	SEC11-T05S-R26E
AMC 432619	Red Bull-680	2015-3789	SEC11-T05S-R26E
AMC 432621	ROCKSTAR 284	2015-3867	SEC06-T06S-R27E
AMC 432622	ROCKSTAR 285	2015-3868	SEC06-T06S-R25E
AMC 432623	ROCKSTAR 286	2015-3869	SEC06-T06S-R25E
AMC 432624	ROCKSTAR 287	2015-3870	SEC06-T06S-R25E
AMC 432625	ROCKSTAR 288	2015-3871	SEC06-T06S-R25E
AMC 432626	ROCKSTAR 289	2015-3872	SEC06-T06S-R25E
AMC 432627	ROCKSTAR 290	2015-3873	SEC06-T06S-R25E
AMC 432628	ROCKSTAR 291	2015-3874	SEC06-T06S-R25E
AMC 432629	ROCKSTAR 292	2015-3875	SEC06-T06S-R25E
AMC 432630	ROCKSTAR 293	2015-3876	SEC06-T06S-R25E
AMC 432631	ROCKSTAR 294	2015-3877	SEC06-T06S-R25E
AMC 432632	ROCKSTAR 295	2015-3878	SEC06-T06S-R25E
AMC 432633	ROCKSTAR 296	2015-3879	SEC06-T06S-R25E
AMC 432634	ROCKSTAR 297	2015-3880	SEC06-T06S-R25E
AMC 432635	ROCKSTAR 298	2015-3881	SEC06-T06S-R25E
AMC 432636	ROCKSTAR 299	2015-3882	SEC06-T06S-R25E
AMC 432637	ROCKSTAR 300	2015-3883	SEC06-T06S-R25E
AMC 432638	ROCKSTAR 301	2015-3884	SEC06-T06S-R25E
AMC 432639	ROCKSTAR 302	2015-3885	SEC06-T06S-R25E
AMC 432640	ROCKSTAR 303	2015-3886	SEC06-T06S-R25E
AMC 432641	ROCKSTAR 304	2015-3887	SEC06-T06S-R25E
AMC 432642	ROCKSTAR 305	2015-3888	SEC06-T06S-R25E
AMC 432643	ROCKSTAR 306	2015-3889	SEC06-T06S-R25E
AMC 432644	ROCKSTAR 307	2015-3890	SEC06-T06S-R25E
AMC 432645	ROCKSTAR 308	2015-3891	SEC06-T06S-R25E
AMC 432646	ROCKSTAR 309	2015-3892	SEC06-T06S-R25E
AMC 432647	ROCKSTAR 310	2015-3893	SEC06-T06S-R25E
AMC 432648	ROCKSTAR 311	2015-3894	SEC06-T06S-R25E
AMC 432649	ROCKSTAR 312	2015-3895	SEC06-T06S-R25E
AMC 432650	ROCKSTAR 313	2015-3896	SEC06-T06S-R25E
AMC 432651	ROCKSTAR 314	2015-3897	SEC05-T06S-R25E

INDONESIA  
 REPUBLIC OF  
 MOZAMBIQUE

EXHIBIT A

AMC 432652	ROCKSTAR 315	2015-3898	SEC05-T06S-R25E
AMC 432653	ROCKSTAR 316	2015-3899	SEC05-T06S-R25E
AMC 432654	ROCKSTAR 317	2015-3900	SEC05-T06S-R25E
AMC 432655	ROCKSTAR 318	2015-3901	SEC05-T06S-R25E
AMC 432656	ROCKSTAR 319	2015-3902	SEC05-T06S-R25E
AMC 432657	ROCKSTAR 320	2015-3903	SEC05-T06S-R25E
AMC 432658	ROCKSTAR 321	2015-3904	SEC05-T06S-R25E
AMC 432659	ROCKSTAR 322	2015-3905	SEC05-T06S-R25E
AMC 432660	ROCKSTAR 323	2015-3906	SEC05-T06S-R25E
AMC 432661	ROCKSTAR 324	2015-3907	SEC05-T06S-R25E
AMC 432662	ROCKSTAR 325	2015-3908	SEC05-T06S-R25E
AMC 432663	ROCKSTAR 326	2015-3909	SEC05-T06S-R25E
AMC 432664	ROCKSTAR 327	2015-3910	SEC05-T06S-R25E
AMC 432665	ROCKSTAR 328	2015-3911	SEC05-T06S-R25E
AMC 432666	ROCKSTAR 329	2015-3912	SEC05-T06S-R25E
AMC 432667	ROCKSTAR 330	2015-3913	SEC05-T06S-R25E
AMC 432668	ROCKSTAR 331	2015-3914	SEC05-T06S-R25E
AMC 432669	ROCKSTAR 332	2015-3915	SEC05-T06S-R25E
AMC 432670	ROCKSTAR 333	2015-3916	SEC05-T06S-R25E
AMC 432671	ROCKSTAR 334	2015-3917	SEC05-T06S-R25E
AMC 432672	ROCKSTAR 335	2015-3918	SEC05-T06S-R25E
AMC 432673	ROCKSTAR 336	2015-3919	SEC05-T06S-R25E
AMC 432674	ROCKSTAR 337	2015-3920	SEC05-T06S-R25E
AMC 432675	ROCKSTAR 338	2015-3921	SEC05-T06S-R25E
AMC 432676	ROCKSTAR 339	2015-3922	SEC05-T06S-R25E
AMC 432677	ROCKSTAR 340	2015-3923	SEC05-T06S-R25E
AMC 432678	ROCKSTAR 341	2015-3924	SEC05-T06S-R25E
AMC 432679	ROCKSTAR 342	2015-3925	SEC05-T06S-R25E
AMC 432680	ROCKSTAR 343	2015-3926	SEC05-T06S-R25E
AMC 432681	ROCKSTAR 344	2015-3927	SEC05-T06S-R25E
AMC 432682	ROCKSTAR 345	2015-3928	SEC05-T06S-R25E
AMC 432683	ROCKSTAR 346	2015-3929	SEC05-T06S-R25E
AMC 432684	ROCKSTAR 347	2015-3930	SEC05-T06S-R25E
AMC 432685	ROCKSTAR 348	2015-3931	SEC05-T06S-R25E
AMC 432686	ROCKSTAR 349	2015-3932	SEC05-T06S-R25E
AMC 432687	ROCKSTAR 350	2015-3933	SEC04-T06S-R25E
AMC 432688	ROCKSTAR 351	2015-3934	SEC04-T06S-R25E
AMC 432689	ROCKSTAR 352	2015-3935	SEC04-T06S-R25E
AMC 432690	ROCKSTAR 353	2015-3936	SEC04-T06S-R25E
AMC 432691	ROCKSTAR 354	2015-3937	SEC04-T06S-R25E
AMC 432692	ROCKSTAR 355	2015-3938	SEC04-T06S-R25E
AMC 432693	ROCKSTAR 356	2015-3939	SEC04-T06S-R25E
AMC 432694	ROCKSTAR 357	2015-3940	SEC04-T06S-R25E
AMC 432695	ROCKSTAR 358	2015-3941	SEC04-T06S-R25E
AMC 432696	ROCKSTAR 359	2015-3942	SEC04-T06S-R25E
AMC 432697	ROCKSTAR 360	2015-3943	SEC04-T06S-R25E
AMC 432698	ROCKSTAR 361	2015-3944	SEC04-T06S-R25E

PHOENIX, ARIZONA  
 2017 OCT 12 PM 4:56  
 4b

EXHIBIT A

AMC 432699	ROCKSTAR 362	2015-3945	SEC04-T06S-R25E
AMC 432700	ROCKSTAR 363	2015-3946	SEC04-T06S-R25E
AMC 432701	ROCKSTAR 364	2015-3947	SEC04-T06S-R25E
AMC 432702	ROCKSTAR 365	2015-3948	SEC04-T06S-R25E
AMC 432703	ROCKSTAR 366	2015-3949	SEC04-T06S-R25E
AMC 432704	ROCKSTAR 367	2015-3950	SEC04-T06S-R25E
AMC 432705	ROCKSTAR 368	2015-3951	SEC03-T06S-R25E
AMC 432706	ROCKSTAR 369	2015-3952	SEC03-T06S-R25E
AMC 432707	ROCKSTAR 370	2015-3953	SEC03-T06S-R25E
AMC 432708	ROCKSTAR 371	2015-3954	SEC03-T06S-R25E
AMC 432709	ROCKSTAR 372	2015-3955	SEC03-T06S-R25E
AMC 432710	ROCKSTAR 373	2015-3956	SEC03-T06S-R25E
AMC 432711	ROCKSTAR 374	2015-3957	SEC03-T06S-R25E
AMC 432712	ROCKSTAR 375	2015-3958	SEC03-T06S-R25E
AMC 432713	ROCKSTAR 376	2015-3959	SEC03-T06S-R25E
AMC 432714	ROCKSTAR 377	2015-3960	SEC03-T06S-R25E
AMC 432715	ROCKSTAR 378	2015-3961	SEC03-T06S-R25E
AMC 432716	ROCKSTAR 379	2015-3962	SEC03-T06S-R25E
AMC 432717	ROCKSTAR 380	2015-3963	SEC03-T06S-R25E
AMC 432718	ROCKSTAR 381	2015-3964	SEC03-T06S-R25E
AMC 432719	ROCKSTAR 382	2015-3965	SEC03-T06S-R25E
AMC 432720	ROCKSTAR 383	2015-3966	SEC03-T06S-R25E
AMC 432721	ROCKSTAR 384	2015-3967	SEC03-T06S-R25E
AMC 432722	ROCKSTAR 385	2015-3968	SEC03-T06S-R25E
AMC 432723	ROCKSTAR 386	2015-3969	SEC03-T06S-R25E
AMC 432724	ROCKSTAR 387	2015-3970	SEC03-T06S-R25E
AMC 432725	ROCKSTAR 388	2015-3971	SEC03-T06S-R25E
AMC 432726	ROCKSTAR 389	2015-3972	SEC03-T06S-R25E
AMC 432727	ROCKSTAR 390	2015-3973	SEC03-T06S-R25E
AMC 432728	ROCKSTAR 391	2015-3974	SEC03-T06S-R25E
AMC 432729	ROCKSTAR 392	2015-3975	SEC03-T06S-R25E
AMC 432730	ROCKSTAR 393	2015-3976	SEC03-T06S-R25E
AMC 432731	ROCKSTAR 394	2015-3977	SEC03-T06S-R25E
AMC 432732	ROCKSTAR 395	2015-3978	SEC03-T06S-R25E
AMC 432733	ROCKSTAR 396	2015-3979	SEC03-T06S-R25E
AMC 432734	ROCKSTAR 397	2015-3980	SEC03-T06S-R25E
AMC 432735	ROCKSTAR 398	2015-3981	SEC03-T06S-R25E
AMC 432736	ROCKSTAR 399	2015-3982	SEC03-T06S-R25E
AMC 432737	ROCKSTAR 400	2015-3983	SEC03-T06S-R25E
AMC 432738	ROCKSTAR 401	2015-3984	SEC03-T06S-R25E
AMC 432739	ROCKSTAR 402	2015-3985	SEC03-T06S-R25E
AMC 432740	ROCKSTAR 403	2015-3986	SEC02-T06S-R25E
AMC 432741	ROCKSTAR 404	2015-3987	SEC02-T06S-R25E
AMC 432742	ROCKSTAR 405	2015-3988	SEC02-T06S-R25E
AMC 432743	ROCKSTAR 406	2015-3989	SEC02-T06S-R25E
AMC 432744	ROCKSTAR 407	2015-3990	SEC02-T06S-R25E
AMC 432745	ROCKSTAR 408	2015-3991	SEC02-T06S-R25E

RECEIVED  
JUL 11 2015  
FBI  
COMMUNICATIONS SECTION





EXHIBIT A

AMC 432793	ROCKSTAR 456	2015-4039	SEC09-T06S-R25E
AMC 432794	ROCKSTAR 457	2015-4040	SEC09-T06S-R25E
AMC 432795	ROCKSTAR 458	2015-4041	SEC09-T06S-R25E
AMC 432796	ROCKSTAR 459	2015-4042	SEC09-T06S-R25E
AMC 432797	ROCKSTAR 460	2015-4043	SEC09-T06S-R25E
AMC 432798	ROCKSTAR 461	2015-4044	SEC09-T06S-R25E
AMC 432799	ROCKSTAR 462	2015-4045	SEC09-T06S-R25E
AMC 432800	ROCKSTAR 463	2015-4046	SEC09-T06S-R25E
AMC 432801	ROCKSTAR 464	2015-4047	SEC09-T06S-R25E
AMC 432802	ROCKSTAR 465	2015-4048	SEC09-T06S-R25E
AMC 432803	ROCKSTAR 466	2015-4049	SEC09-T06S-R25E
AMC 432804	ROCKSTAR 467	2015-4050	SEC09-T06S-R25E
AMC 432805	ROCKSTAR 468	2015-4051	SEC09-T06S-R25E
AMC 432806	ROCKSTAR 469	2015-4052	SEC09-T06S-R25E
AMC 432807	ROCKSTAR 470	2015-4053	SEC09-T06S-R25E
AMC 432808	ROCKSTAR 471	2015-4054	SEC09-T06S-R25E
AMC 432809	ROCKSTAR 472	2015-4055	SEC10-T06S-R25E
AMC 432810	ROCKSTAR 473	2015-4056	SEC10-T06S-R25E
AMC 432811	ROCKSTAR 474	2015-4057	SEC10-T06S-R25E
AMC 432812	ROCKSTAR 475	2015-4058	SEC10-T06S-R25E
AMC 432813	ROCKSTAR 476	2015-4059	SEC10-T06S-R25E
AMC 432814	ROCKSTAR 477	2015-4060	SEC10-T06S-R25E
AMC 432815	ROCKSTAR 478	2015-4061	SEC10-T06S-R25E
AMC 432816	ROCKSTAR 479	2015-4062	SEC10-T06S-R25E
AMC 432817	ROCKSTAR 480	2015-4063	SEC10-T06S-R25E
AMC 432818	ROCKSTAR 481	2015-4064	SEC10-T06S-R25E
AMC 432819	ROCKSTAR 482	2015-4065	SEC10-T06S-R25E
AMC 432820	ROCKSTAR 483	2015-4066	SEC10-T06S-R25E
AMC 432821	ROCKSTAR 484	2015-4067	SEC10-T06S-R25E
AMC 432822	ROCKSTAR 485	2015-4068	SEC10-T06S-R25E
AMC 432823	ROCKSTAR 486	2015-4069	SEC10-T06S-R25E
AMC 432824	ROCKSTAR 487	2015-4070	SEC10-T06S-R25E
AMC 432825	ROCKSTAR 488	2015-4071	SEC10-T06S-R25E
AMC 432826	ROCKSTAR 489	2015-4072	SEC10-T06S-R25E
AMC 432827	ROCKSTAR 490	2015-4073	SEC10-T06S-R25E
AMC 432828	ROCKSTAR 491	2015-4074	SEC10-T06S-R25E
AMC 432829	ROCKSTAR 492	2015-4075	SEC10-T06S-R25E
AMC 432830	ROCKSTAR 493	2015-4076	SEC10-T06S-R25E
AMC 432831	ROCKSTAR 494	2015-4077	SEC10-T06S-R25E
AMC 432832	ROCKSTAR 495	2015-4078	SEC10-T06S-R25E
AMC 432833	ROCKSTAR 496	2015-4079	SEC10-T06S-R25E
AMC 432834	ROCKSTAR 497	2015-4080	SEC10-T06S-R25E
AMC 432835	ROCKSTAR 498	2015-4081	SEC10-T06S-R25E
AMC 432836	ROCKSTAR 499	2015-4082	SEC10-T06S-R25E
AMC 432837	ROCKSTAR 500	2015-4083	SEC10-T06S-R25E
AMC 432838	ROCKSTAR 501	2015-4084	SEC10-T06S-R25E
AMC 432839	ROCKSTAR 502	2015-4085	SEC10-T06S-R25E

RECEIVED  
2015 SEP 15 10 13 AM  
SECURITY DIVISION

EXHIBIT A

AMC 432840	ROCKSTAR 503	2015-4086	SEC10-T06S-R25E
AMC 432841	ROCKSTAR 504	2015-4087	SEC10-T06S-R25E
AMC 432842	ROCKSTAR 505	2015-4088	SEC10-T06S-R25E
AMC 432843	ROCKSTAR 506	2015-4089	SEC10-T06S-R25E
AMC 432844	ROCKSTAR 507	2015-4090	SEC11-T06S-R25E
AMC 432845	ROCKSTAR 508	2015-4091	SEC11-T06S-R25E
AMC 432846	ROCKSTAR 509	2015-4092	SEC11-T06S-R25E
AMC 432847	ROCKSTAR 510	2015-4093	SEC11-T06S-R25E
AMC 432848	ROCKSTAR 511	2015-4094	SEC11-T06S-R25E
AMC 432849	ROCKSTAR 512	2015-4095	SEC11-T06S-R25E
AMC 432850	ROCKSTAR 513	2015-4096	SEC11-T06S-R25E
AMC 432851	ROCKSTAR 514	2015-4097	SEC11-T06S-R25E
AMC 432852	ROCKSTAR 515	2015-4098	SEC11-T06S-R25E
AMC 432853	ROCKSTAR 516	2015-4099	SEC11-T06S-R25E
AMC 432854	ROCKSTAR 517	2015-4100	SEC11-T06S-R25E
AMC 432855	ROCKSTAR 518	2015-4101	SEC11-T06S-R25E
AMC 432856	ROCKSTAR 519	2015-4102	SEC11-T06S-R25E
AMC 432857	ROCKSTAR 520	2015-4103	SEC11-T06S-R25E
AMC 432858	ROCKSTAR 521	2015-4104	SEC11-T06S-R25E
AMC 432859	ROCKSTAR 522	2015-4105	SEC11-T06S-R25E
AMC 432860	ROCKSTAR 523	2015-4106	SEC11-T06S-R25E
AMC 432861	ROCKSTAR 524	2015-4107	SEC11-T06S-R25E
AMC 432862	ROCKSTAR 525	2015-4108	SEC11-T06S-R25E
AMC 432863	ROCKSTAR 526	2015-4109	SEC11-T06S-R25E
AMC 432864	ROCKSTAR 527	2015-4110	SEC11-T06S-R25E
AMC 432865	ROCKSTAR 528	2015-4111	SEC11-T06S-R25E
AMC 432866	ROCKSTAR 529	2015-4112	SEC11-T06S-R25E
AMC 432867	ROCKSTAR 530	2015-4113	SEC11-T06S-R25E
AMC 432868	ROCKSTAR 531	2015-4114	SEC11-T06S-R25E
AMC 432869	ROCKSTAR 532	2015-4115	SEC11-T06S-R25E
AMC 432870	ROCKSTAR 533	2015-4116	SEC11-T06S-R25E
AMC 432871	ROCKSTAR 534	2015-4117	SEC15-T06S-R25E
AMC 432872	ROCKSTAR 535	2015-4118	SEC15-T06S-R25E
AMC 432873	ROCKSTAR 536	2015-4119	SEC15-T06S-R25E
AMC 432874	ROCKSTAR 537	2015-4120	SEC15-T06S-R25E
AMC 432875	ROCKSTAR 538	2015-4121	SEC15-T06S-R25E
AMC 432876	ROCKSTAR 539	2015-4122	SEC15-T06S-R25E
AMC 432877	ROCKSTAR 540	2015-4123	SEC15-T06S-R25E
AMC 432878	ROCKSTAR 541	2015-4124	SEC15-T06S-R25E
AMC 432879	ROCKSTAR 542	2015-4125	SEC15-T06S-R25E
AMC 432880	ROCKSTAR 543	2015-4126	SEC15-T06S-R25E
AMC 432881	ROCKSTAR 544	2015-4127	SEC15-T06S-R25E
AMC 432882	ROCKSTAR 545	2015-4128	SEC15-T06S-R25E
AMC 432883	ROCKSTAR 546	2015-4129	SEC15-T06S-R25E
AMC 432884	ROCKSTAR 547	2015-4130	SEC15-T06S-R25E
AMC 432885	ROCKSTAR 548	2015-4131	SEC15-T06S-R25E
AMC 432886	ROCKSTAR 549	2015-4132	SEC15-T06S-R25E

PHOENIX, ARIZONA  
NOV 27 2015  
36

EXHIBIT A

AMC 432887	ROCKSTAR 550	2015-4133	SEC15-T06S-R25E
AMC 432888	ROCKSTAR 551	2015-4134	SEC15-T06S-R25E
AMC 432889	ROCKSTAR 552	2015-4135	SEC15-T06S-R25E
AMC 432890	ROCKSTAR 553	2015-4136	SEC15-T06S-R25E
AMC 432891	ROCKSTAR 554	2015-4137	SEC15-T06S-R25E
AMC 432892	ROCKSTAR 555	2015-4138	SEC15-T06S-R25E
AMC 432893	ROCKSTAR 556	2015-4139	SEC15-T06S-R25E
AMC 432894	ROCKSTAR 557	2015-4140	SEC15-T06S-R25E
AMC 432895	ROCKSTAR 558	2015-4141	SEC15-T06S-R25E
AMC 432896	ROCKSTAR 559	2015-4142	SEC15-T06S-R25E
AMC 432897	ROCKSTAR 560	2015-4143	SEC15-T06S-R25E
AMC 432898	ROCKSTAR 561	2015-4144	SEC15-T06S-R25E
AMC 432899	ROCKSTAR 562	2015-4145	SEC15-T06S-R25E
AMC 432900	ROCKSTAR 563	2015-4146	SEC15-T06S-R25E
AMC 432901	ROCKSTAR 564	2015-4147	SEC14-T06S-R25E
AMC 432902	ROCKSTAR 565	2015-4148	SEC14-T06S-R25E
AMC 432903	ROCKSTAR 566	2015-4149	SEC14-T06S-R25E
AMC 432904	ROCKSTAR 567	2015-4150	SEC14-T06S-R25E
AMC 432905	ROCKSTAR 568	2015-4151	SEC14-T06S-R25E
AMC 432906	ROCKSTAR 569	2015-4152	SEC14-T06S-R25E
AMC 432907	ROCKSTAR 570	2015-4153	SEC14-T06S-R25E
AMC 432908	ROCKSTAR 571	2015-4154	SEC14-T06S-R25E
AMC 432909	ROCKSTAR 572	2015-4155	SEC14-T06S-R25E
AMC 432910	ROCKSTAR 573	2015-4156	SEC14-T06S-R25E
AMC 432911	ROCKSTAR 574	2015-4157	SEC14-T06S-R25E
AMC 432912	ROCKSTAR 575	2015-4158	SEC14-T06S-R25E
AMC 432913	ROCKSTAR 576	2015-4159	SEC14-T06S-R25E
AMC 432914	ROCKSTAR 577	2015-4160	SEC14-T06S-R25E
AMC 432915	ROCKSTAR 578	2015-4161	SEC14-T06S-R25E
AMC 432916	ROCKSTAR 579	2015-4162	SEC14-T06S-R25E
AMC 432917	ROCKSTAR 580	2015-4163	SEC14-T06S-R25E
AMC 432918	ROCKSTAR 581	2015-4164	SEC14-T06S-R25E
AMC 432919	ROCKSTAR 582	2015-4165	SEC14-T06S-R25E
AMC 432920	ROCKSTAR 583	2015-4166	SEC14-T06S-R25E
AMC 432921	ROCKSTAR 584	2015-4167	SEC14-T06S-R25E
AMC 432922	ROCKSTAR 585	2015-4168	SEC14-T06S-R25E
AMC 432923	ROCKSTAR 586	2015-4169	SEC14-T06S-R25E
AMC 432924	ROCKSTAR 587	2015-4170	SEC14-T06S-R25E
AMC 432925	ROCKSTAR 588	2015-4171	SEC14-T06S-R25E
AMC 432926	ROCKSTAR 589	2015-4172	SEC14-T06S-R25E
AMC 432927	ROCKSTAR 590	2015-4173	SEC14-T06S-R25E
AMC 432928	ROCKSTAR 591	2015-4174	SEC14-T06S-R25E
AMC 432929	ROCKSTAR 592	2015-4175	SEC14-T06S-R25E
AMC 432930	ROCKSTAR 593	2015-4176	SEC14-T06S-R25E
AMC 432931	ROCKSTAR 594	2015-4177	SEC14-T06S-R25E
AMC 432994	ROCKSTAR 595	2015-4259	SEC13-T06S-R25E
AMC 432995	ROCKSTAR 596	2015-4260	SEC13-T06S-R25E

RECEIVED  
 SECURITIES  
 DIVISION  
 JUN 15 2015  
 156

EXHIBIT A

AMC 432996	ROCKSTAR 597	2015-4261	SEC13-T06S-R25E
AMC 432997	ROCKSTAR 598	2015-4262	SEC13-T06S-R25E
AMC 432998	ROCKSTAR 599	2015-4263	SEC13-T06S-R25E
AMC 432999	ROCKSTAR 600	2015-4264	SEC13-T06S-R25E
AMC 433000	ROCKSTAR 601	2015-4265	SEC13-T06S-R25E
AMC 433001	ROCKSTAR 602	2015-4266	SEC13-T06S-R25E
AMC 433002	ROCKSTAR 603	2015-4267	SEC13-T06S-R25E
AMC 433003	ROCKSTAR 604	2015-4268	SEC13-T06S-R25E
AMC 433004	ROCKSTAR 605	2015-4269	SEC13-T06S-R25E
AMC 433005	ROCKSTAR 606	2015-4270	SEC13-T06S-R25E
AMC 433006	ROCKSTAR 607	2015-4271	SEC13-T06S-R25E
AMC 433007	ROCKSTAR 608	2015-4272	SEC13-T06S-R25E
AMC 433008	ROCKSTAR 609	2015-4273	SEC13-T06S-R25E
AMC 433009	ROCKSTAR 610	2015-4274	SEC13-T06S-R25E
AMC 433010	ROCKSTAR 611	2015-4275	SEC13-T06S-R25E
AMC 433011	ROCKSTAR 612	2015-4276	SEC13-T06S-R25E
AMC 433012	ROCKSTAR 613	2015-4277	SEC13-T06S-R25E
AMC 433013	ROCKSTAR 614	2015-4278	SEC13-T06S-R25E
AMC 433014	ROCKSTAR 615	2015-4279	SEC23-T06S-R25E
AMC 433015	ROCKSTAR 616	2015-4280	SEC23-T06S-R25E
AMC 433016	ROCKSTAR 617	2015-4281	SEC23-T06S-R25E
AMC 433017	ROCKSTAR 618	2015-4282	SEC23-T06S-R25E
AMC 433018	ROCKSTAR 619	2015-4283	SEC23-T06S-R25E
AMC 433019	ROCKSTAR 620	2015-4284	SEC23-T06S-R25E
AMC 433020	ROCKSTAR 621	2015-4285	SEC23-T06S-R25E
AMC 433021	ROCKSTAR 622	2015-4286	SEC23-T06S-R25E
AMC 433022	ROCKSTAR 623	2015-4287	SEC23-T06S-R25E
AMC 433023	ROCKSTAR 624	2015-4288	SEC23-T06S-R25E
AMC 433024	ROCKSTAR 625	2015-4289	SEC23-T06S-R25E
AMC 433025	ROCKSTAR 626	2015-4290	SEC23-T06S-R25E
AMC 433026	ROCKSTAR 627	2015-4291	SEC23-T06S-R25E
AMC 433027	ROCKSTAR 628	2015-4292	SEC23-T06S-R25E
AMC 433028	ROCKSTAR 629	2015-4293	SEC23-T06S-R25E
AMC 433029	ROCKSTAR 630	2015-4294	SEC23-T06S-R25E
AMC 433030	ROCKSTAR 631	2015-4295	SEC23-T06S-R25E
AMC 433031	ROCKSTAR 632	2015-4296	SEC23-T06S-R25E
AMC 433032	ROCKSTAR 633	2015-4297	SEC23-T06S-R25E
AMC 433033	ROCKSTAR 634	2015-4298	SEC23-T06S-R25E
AMC 433034	ROCKSTAR 635	2015-4299	SEC23-T06S-R25E
AMC 433035	ROCKSTAR 636	2015-4300	SEC23-T06S-R25E
AMC 433036	ROCKSTAR 637	2015-4301	SEC23-T06S-R25E
AMC 433037	ROCKSTAR 638	2015-4302	SEC23-T06S-R25E
AMC 433038	ROCKSTAR 639	2015-4303	SEC23-T06S-R25E
AMC 433039	ROCKSTAR 640	2015-4304	SEC23-T06S-R25E
AMC 433040	ROCKSTAR 641	2015-4305	SEC23-T06S-R25E
AMC 433041	ROCKSTAR 642	2015-4306	SEC23-T06S-R25E
AMC 433042	ROCKSTAR 643	2015-4307	SEC23-T06S-R25E

PHOENIX, ARIZONA  
MAY 12 2015  
12:00 PM

EXHIBIT A

AMC 433043	ROCKSTAR 644	2015-4308	SEC23-T06S-R25E
AMC 433044	ROCKSTAR 645	2015-4309	SEC23-T06S-R25E
AMC 433045	ROCKSTAR 646	2015-4310	SEC23-T06S-R25E
AMC 433046	ROCKSTAR 647	2015-4311	SEC24-T06S-R25E
AMC 433047	ROCKSTAR 648	2015-4312	SEC24-T06S-R25E
AMC 433048	ROCKSTAR 649	2015-4313	SEC24-T06S-R25E
AMC 433049	ROCKSTAR 650	2015-4314	SEC24-T06S-R25E
AMC 433050	ROCKSTAR 651	2015-4315	SEC24-T06S-R25E
AMC 433051	ROCKSTAR 652	2015-4316	SEC24-T06S-R25E
AMC 433052	ROCKSTAR 653	2015-4317	SEC24-T06S-R25E
AMC 433053	ROCKSTAR 654	2015-4318	SEC24-T06S-R25E
AMC 433054	ROCKSTAR 655	2015-4319	SEC24-T06S-R25E
AMC 433055	ROCKSTAR 656	2015-4320	SEC24-T06S-R25E
AMC 433056	ROCKSTAR 657	2015-4321	SEC24-T06S-R25E
AMC 433057	ROCKSTAR 658	2015-4322	SEC24-T06S-R25E
AMC 433058	ROCKSTAR 659	2015-4323	SEC24-T06S-R25E
AMC 433059	ROCKSTAR 660	2015-4324	SEC24-T06S-R25E
AMC 433060	ROCKSTAR 661	2015-4325	SEC24-T06S-R25E
AMC 433061	ROCKSTAR 662	2015-4326	SEC24-T06S-R25E
AMC 433062	ROCKSTAR 663	2015-4327	SEC24-T06S-R25E
AMC 433063	ROCKSTAR 664	2015-4328	SEC24-T06S-R25E
AMC 433064	ROCKSTAR 665	2015-4329	SEC24-T06S-R25E
AMC 433065	ROCKSTAR 666	2015-4330	SEC24-T06S-R25E
AMC 433066	ROCKSTAR 667	2015-4331	SEC24-T06S-R25E
AMC 433067	ROCKSTAR 668	2015-4332	SEC24-T06S-R25E
AMC 433068	ROCKSTAR 669	2015-4333	SEC24-T06S-R25E
AMC 433069	ROCKSTAR 670	2015-4334	SEC24-T06S-R25E
AMC 433070	ROCKSTAR 671	2015-4335	SEC24-T06S-R25E
AMC 433071	ROCKSTAR 672	2015-4336	SEC24-T06S-R25E
AMC 433072	ROCKSTAR 673	2015-4337	SEC24-T06S-R25E
AMC 433073	ROCKSTAR 674	2015-4338	SEC24-T06S-R25E
AMC 433074	ROCKSTAR 675	2015-4339	SEC24-T06S-R25E
AMC 433075	ROCKSTAR 676	2015-4340	SEC24-T06S-R25E
AMC 433076	ROCKSTAR 677	2015-4341	SEC24-T06S-R25E
AMC 433077	ROCKSTAR 678	2015-4342	SEC24-T06S-R25E
AMC 433078	ROCKSTAR 679	2015-4343	SEC24-T06S-R25E
AMC 433079	ROCKSTAR 680	2015-4344	SEC24-T06S-R25E
AMC 433080	ROCKSTAR 681	2015-4345	SEC24-T06S-R25E
AMC 433081	ROCKSTAR 682	2015-4346	SEC24-T06S-R25E
AMC 433082	ROCKSTAR 683	2015-4347	SEC25-T06S-R25E
AMC 433083	ROCKSTAR 684	2015-4348	SEC25-T06S-R25E
AMC 433084	ROCKSTAR 685	2015-4349	SEC25-T06S-R25E
AMC 433085	ROCKSTAR 686	2015-4350	SEC25-T06S-R25E
AMC 433086	ROCKSTAR 687	2015-4351	SEC25-T06S-R25E
AMC 433087	ROCKSTAR 688	2015-4352	SEC25-T06S-R25E
AMC 433088	ROCKSTAR 689	2015-4353	SEC25-T06S-R25E
AMC 433089	ROCKSTAR 690	2015-4354	SEC25-T06S-R25E

RECEIVED  
DEC 11 11:36  
FBI  
FEDERAL BUREAU OF INVESTIGATION  
U.S. DEPARTMENT OF JUSTICE

EXHIBIT A

AMC 433090	ROCKSTAR 691	2015-4355	SEC25-T06S-R25E
AMC 433091	ROCKSTAR 692	2015-4356	SEC25-T06S-R25E
AMC 433092	ROCKSTAR 693	2015-4357	SEC25-T06S-R25E
AMC 433093	ROCKSTAR 694	2015-4358	SEC25-T06S-R25E
AMC 433094	ROCKSTAR 695	2015-4359	SEC25-T06S-R25E
AMC 433095	ROCKSTAR 696	2015-4360	SEC25-T06S-R25E
AMC 433096	ROCKSTAR 697	2015-4361	SEC25-T06S-R25E
AMC 433097	ROCKSTAR 698	2015-4362	SEC25-T06S-R25E
AMC 433098	ROCKSTAR 699	2015-4363	SEC25-T06S-R25E
AMC 433099	ROCKSTAR 700	2015-4364	SEC25-T06S-R25E
AMC 433100	ROCKSTAR 701	2015-4365	SEC25-T06S-R25E
AMC 433101	ROCKSTAR 702	2015-4366	SEC25-T06S-R25E
AMC 433102	ROCKSTAR 703	2015-4367	SEC25-T06S-R25E
AMC 433103	ROCKSTAR 704	2015-4368	SEC25-T06S-R25E
AMC 433104	ROCKSTAR 705	2015-4369	SEC25-T06S-R25E
AMC 433105	ROCKSTAR 706	2015-4370	SEC25-T06S-R25E
AMC 433106	ROCKSTAR 707	2015-4371	SEC25-T06S-R25E
AMC 433107	ROCKSTAR 708	2015-4372	SEC25-T06S-R25E
AMC 433108	ROCKSTAR 709	2015-4373	SEC25-T06S-R25E
AMC 433109	ROCKSTAR 710	2015-4374	SEC18-T06S-R26E
AMC 433110	ROCKSTAR 711	2015-4375	SEC18-T06S-R26E
AMC 433111	ROCKSTAR 712	2015-4376	SEC18-T06S-R26E
AMC 433112	ROCKSTAR 713	2015-4377	SEC18-T06S-R26E
AMC 433113	ROCKSTAR 714	2015-4378	SEC18-T06S-R26E
AMC 433114	ROCKSTAR 715	2015-4379	SEC18-T06S-R26E
AMC 433115	ROCKSTAR 716	2015-4380	SEC18-T06S-R26E
AMC 433116	ROCKSTAR 717	2015-4381	SEC18-T06S-R26E
AMC 433117	ROCKSTAR 718	2015-4382	SEC18-T06S-R26E
AMC 433118	ROCKSTAR 719	2015-4383	SEC18-T06S-R26E
AMC 433119	ROCKSTAR 720	2015-4384	SEC18-T06S-R26E
AMC 433120	ROCKSTAR 721	2015-4385	SEC18-T06S-R26E
AMC 433121	ROCKSTAR 722	2015-4386	SEC18-T06S-R26E
AMC 433122	ROCKSTAR 723	2015-4387	SEC18-T06S-R26E
AMC 433123	ROCKSTAR 724	2015-4388	SEC18-T06S-R26E
AMC 433124	ROCKSTAR 725	2015-4389	SEC18-T06S-R26E
AMC 433125	ROCKSTAR 726	2015-4390	SEC18-T06S-R26E
AMC 433126	ROCKSTAR 727	2015-4391	SEC19-T06S-R26E
AMC 433127	ROCKSTAR 728	2015-4392	SEC19-T06S-R26E
AMC 433128	ROCKSTAR 729	2015-4393	SEC19-T06S-R26E
AMC 433129	ROCKSTAR 730	2015-4394	SEC19-T06S-R26E
AMC 433130	ROCKSTAR 731	2015-4395	SEC19-T06S-R26E
AMC 433131	ROCKSTAR 732	2015-4396	SEC19-T06S-R26E
AMC 433132	ROCKSTAR 733	2015-4397	SEC19-T06S-R26E
AMC 433133	ROCKSTAR 734	2015-4398	SEC19-T06S-R26E
AMC 433134	ROCKSTAR 735	2015-4399	SEC19-T06S-R26E
AMC 433135	ROCKSTAR 736	2015-4400	SEC19-T06S-R26E
AMC 433136	ROCKSTAR 737	2015-4401	SEC19-T06S-R26E

RECEIVED  
OFFICE OF THE ATTORNEY GENERAL  
ARIZONA  
JUN 13 2013

EXHIBIT A

AMC 433137	ROCKSTAR 738	2015-4402	SEC19-T06S-R26E
AMC 433138	ROCKSTAR 739	2015-4403	SEC19-T06S-R26E
AMC 433139	ROCKSTAR 740	2015-4404	SEC19-T06S-R26E
AMC 433140	ROCKSTAR 741	2015-4405	SEC19-T06S-R26E
AMC 433141	ROCKSTAR 742	2015-4406	SEC19-T06S-R26E
AMC 433142	ROCKSTAR 743	2015-4407	SEC19-T06S-R26E
AMC 433143	ROCKSTAR 744	2015-4408	SEC19-T06S-R26E
AMC 433144	ROCKSTAR 745	2015-4409	SEC19-T06S-R26E
AMC 433145	ROCKSTAR 746	2015-4410	SEC19-T06S-R26E
AMC 433146	ROCKSTAR 747	2015-4411	SEC19-T06S-R26E
AMC 433147	ROCKSTAR 748	2015-4412	SEC19-T06S-R26E
AMC 433148	ROCKSTAR 749	2015-4413	SEC19-T06S-R26E
AMC 433149	ROCKSTAR 750	2015-4414	SEC19-T06S-R26E
AMC 433150	ROCKSTAR 751	2015-4415	SEC19-T06S-R26E
AMC 433151	ROCKSTAR 752	2015-4416	SEC19-T06S-R26E
AMC 433152	ROCKSTAR 753	2015-4417	SEC19-T06S-R26E
AMC 433153	ROCKSTAR 754	2015-4418	SEC20-T06S-R26E
AMC 433154	ROCKSTAR 755	2015-4419	SEC20-T06S-R26E
AMC 433155	ROCKSTAR 756	2015-4420	SEC20-T06S-R26E
AMC 433156	ROCKSTAR 757	2015-4421	SEC20-T06S-R26E
AMC 433157	ROCKSTAR 758	2015-4422	SEC20-T06S-R26E
AMC 433158	ROCKSTAR 759	2015-4423	SEC20-T06S-R26E
AMC 433159	ROCKSTAR 760	2015-4424	SEC20-T06S-R26E
AMC 433160	ROCKSTAR 761	2015-4425	SEC20-T06S-R26E
AMC 433161	ROCKSTAR 762	2015-4426	SEC20-T06S-R26E
AMC 433162	ROCKSTAR 763	2015-4427	SEC20-T06S-R26E
AMC 433163	ROCKSTAR 764	2015-4428	SEC20-T06S-R26E
AMC 433164	ROCKSTAR 765	2015-4429	SEC20-T06S-R26E
AMC 433165	ROCKSTAR 766	2015-4430	SEC20-T06S-R26E
AMC 433166	ROCKSTAR 767	2015-4431	SEC20-T06S-R26E
AMC 433167	ROCKSTAR 768	2015-4432	SEC20-T06S-R26E
AMC 433168	ROCKSTAR 769	2015-4433	SEC20-T06S-R26E
AMC 433169	ROCKSTAR 770	2015-4434	SEC20-T06S-R26E
AMC 433170	ROCKSTAR 771	2015-4435	SEC20-T06S-R26E
AMC 433171	ROCKSTAR 772	2015-4436	SEC20-T06S-R26E
AMC 433172	ROCKSTAR 773	2015-4437	SEC20-T06S-R26E
AMC 433173	ROCKSTAR 774	2015-4438	SEC20-T06S-R26E
AMC 433174	ROCKSTAR 775	2015-4439	SEC20-T06S-R26E
AMC 433175	ROCKSTAR 776	2015-4440	SEC20-T06S-R26E
AMC 433176	ROCKSTAR 777	2015-4441	SEC20-T06S-R26E
AMC 433177	ROCKSTAR 778	2015-4442	SEC20-T06S-R26E
AMC 433178	ROCKSTAR 779	2015-4443	SEC20-T06S-R26E
AMC 433179	ROCKSTAR 780	2015-4444	SEC20-T06S-R26E
AMC 433180	ROCKSTAR 781	2015-4445	SEC20-T06S-R26E
AMC 433181	ROCKSTAR 782	2015-4446	SEC20-T06S-R26E
AMC 433182	ROCKSTAR 783	2015-4447	SEC20-T06S-R26E
AMC 433183	ROCKSTAR 784	2015-4448	SEC20-T06S-R26E

PHOENIX, ARIZONA  
2015 DEC 19 1:36  
OFFICE



EXHIBIT A

AMC 433184	ROCKSTAR 785	2015-4449	SEC20-T06S-R26E
AMC 433185	ROCKSTAR 786	2015-4450	SEC20-T06S-R26E
AMC 433186	ROCKSTAR 787	2015-4451	SEC20-T06S-R26E
AMC 433187	ROCKSTAR 788	2015-4452	SEC20-T06S-R26E
AMC 433188	ROCKSTAR 789	2015-4453	SEC20-T06S-R26E
AMC 433189	ROCKSTAR 790	2015-4454	SEC21-T06S-R26E
AMC 433190	ROCKSTAR 791	2015-4455	SEC21-T06S-R26E
AMC 433191	ROCKSTAR 792	2015-4456	SEC21-T06S-R26E
AMC 433192	ROCKSTAR 793	2015-4457	SEC21-T06S-R26E
AMC 433193	ROCKSTAR 794	2015-4458	SEC21-T06S-R26E
AMC 433194	ROCKSTAR 795	2015-4459	SEC21-T06S-R26E
AMC 433195	ROCKSTAR 796	2015-4460	SEC21-T06S-R26E
AMC 433196	ROCKSTAR 797	2015-4461	SEC21-T06S-R26E
AMC 433197	ROCKSTAR 798	2015-4462	SEC21-T06S-R26E
AMC 433198	ROCKSTAR 799	2015-4463	SEC21-T06S-R26E
AMC 433199	ROCKSTAR 800	2015-4464	SEC21-T06S-R26E
AMC 433200	ROCKSTAR 801	2015-4465	SEC21-T06S-R26E
AMC 433201	ROCKSTAR 802	2015-4466	SEC21-T06S-R26E
AMC 433202	ROCKSTAR 803	2015-4467	SEC21-T06S-R26E
AMC 433203	ROCKSTAR 804	2015-4468	SEC21-T06S-R26E
AMC 433204	ROCKSTAR 805	2015-4469	SEC21-T06S-R26E
AMC 433205	ROCKSTAR 806	2015-4470	SEC21-T06S-R26E
AMC 433206	ROCKSTAR 807	2015-4471	SEC21-T06S-R26E
AMC 433207	ROCKSTAR 808	2015-4472	SEC21-T06S-R26E
AMC 433208	ROCKSTAR 809	2015-4473	SEC21-T06S-R26E
AMC 433209	ROCKSTAR 810	2015-4474	SEC21-T06S-R26E
AMC 433210	ROCKSTAR 811	2015-4475	SEC21-T06S-R26E
AMC 433211	ROCKSTAR 812	2015-4476	SEC21-T06S-R26E
AMC 433212	ROCKSTAR 813	2015-4477	SEC21-T06S-R26E
AMC 433213	ROCKSTAR 814	2015-4478	SEC21-T06S-R26E
AMC 433214	ROCKSTAR 815	2015-4479	SEC21-T06S-R26E
AMC 433215	ROCKSTAR 816	2015-4480	SEC21-T06S-R26E
AMC 433216	ROCKSTAR 817	2015-4481	SEC21-T06S-R26E
AMC 433217	ROCKSTAR 818	2015-4482	SEC21-T06S-R26E
AMC 433218	ROCKSTAR 819	2015-4483	SEC21-T06S-R26E
AMC 433219	ROCKSTAR 820	2015-4484	SEC21-T06S-R26E
AMC 433220	ROCKSTAR 821	2015-4485	SEC21-T06S-R26E
AMC 433221	ROCKSTAR 822	2015-4486	SEC21-T06S-R26E
AMC 433222	ROCKSTAR 823	2015-4487	SEC21-T06S-R26E
AMC 433223	ROCKSTAR 824	2015-4488	SEC21-T06S-R26E
AMC 433224	ROCKSTAR 825	2015-4489	SEC21-T06S-R26E
AMC 433225	ROCKSTAR 826	2015-4490	SEC22-T06S-R26E
AMC 433226	ROCKSTAR 827	2015-4491	SEC22-T06S-R26E
AMC 433227	ROCKSTAR 828	2015-4492	SEC22-T06S-R26E
AMC 433228	ROCKSTAR 829	2015-4493	SEC22-T06S-R26E
AMC 433229	ROCKSTAR 830	2015-4494	SEC22-T06S-R26E
AMC 433230	ROCKSTAR 831	2015-4495	SEC22-T06S-R26E

RECEIVED  
JUN 10 2015  
10:36

EXHIBIT A

AMC 433231	ROCKSTAR 832	2015-4496	SEC22-T06S-R26E
AMC 433232	ROCKSTAR 833	2015-4497	SEC22-T06S-R26E
AMC 433233	ROCKSTAR 834	2015-4498	SEC22-T06S-R26E
AMC 433234	ROCKSTAR 835	2015-4499	SEC22-T06S-R26E
AMC 433235	ROCKSTAR 836	2015-4500	SEC22-T06S-R26E
AMC 433236	ROCKSTAR 837	2015-4501	SEC22-T06S-R26E
AMC 433237	ROCKSTAR 838	2015-4502	SEC22-T06S-R26E
AMC 433238	ROCKSTAR 839	2015-4503	SEC22-T06S-R26E
AMC 433239	ROCKSTAR 840	2015-4504	SEC22-T06S-R26E
AMC 433240	ROCKSTAR 841	2015-4505	SEC22-T06S-R26E
AMC 433241	ROCKSTAR 842	2015-4506	SEC22-T06S-R26E
AMC 433242	ROCKSTAR 843	2015-4507	SEC22-T06S-R26E
AMC 433243	ROCKSTAR 844	2015-4508	SEC22-T06S-R26E
AMC 433244	ROCKSTAR 845	2015-4509	SEC22-T06S-R26E
AMC 433245	ROCKSTAR 846	2015-4510	SEC22-T06S-R26E
AMC 433246	ROCKSTAR 847	2015-4511	SEC22-T06S-R26E
AMC 433247	ROCKSTAR 848	2015-4512	SEC22-T06S-R26E
AMC 433248	ROCKSTAR 849	2015-4513	SEC22-T06S-R26E
AMC 433249	ROCKSTAR 850	2015-4514	SEC22-T06S-R26E
AMC 433250	ROCKSTAR 851	2015-4515	SEC22-T06S-R26E
AMC 433251	ROCKSTAR 852	2015-4516	SEC22-T06S-R26E
AMC 433252	ROCKSTAR 853	2015-4517	SEC22-T06S-R26E
AMC 433253	ROCKSTAR 854	2015-4518	SEC22-T06S-R26E
AMC 433254	ROCKSTAR 855	2015-4519	SEC22-T06S-R26E
AMC 433255	ROCKSTAR 856	2015-4520	SEC22-T06S-R26E
AMC 433256	ROCKSTAR 857	2015-4521	SEC22-T06S-R26E
AMC 433257	ROCKSTAR 858	2015-4522	SEC22-T06S-R26E
AMC 433258	ROCKSTAR 859	2015-4523	SEC22-T06S-R26E
AMC 433259	ROCKSTAR 860	2015-4524	SEC22-T06S-R26E
AMC 433260	ROCKSTAR 861	2015-4525	SEC22-T06S-R26E
AMC 433261	ROCKSTAR 862	2015-4526	SEC27-T06S-R26E
AMC 433262	ROCKSTAR 863	2015-4527	SEC27-T06S-R26E
AMC 433263	ROCKSTAR 864	2015-4528	SEC27-T06S-R26E
AMC 433264	ROCKSTAR 865	2015-4529	SEC27-T06S-R26E
AMC 433265	ROCKSTAR 866	2015-4530	SEC27-T06S-R26E
AMC 433266	ROCKSTAR 867	2015-4531	SEC27-T06S-R26E
AMC 433267	ROCKSTAR 868	2015-4532	SEC27-T06S-R26E
AMC 433268	ROCKSTAR 869	2015-4533	SEC27-T06S-R26E
AMC 433269	ROCKSTAR 870	2015-4534	SEC27-T06S-R26E
AMC 433270	ROCKSTAR 871	2015-4535	SEC27-T06S-R26E
AMC 433271	ROCKSTAR 872	2015-4536	SEC27-T06S-R26E
AMC 433272	ROCKSTAR 873	2015-4537	SEC27-T06S-R26E
AMC 433273	ROCKSTAR 874	2015-4538	SEC27-T06S-R26E
AMC 433274	ROCKSTAR 875	2015-4539	SEC27-T06S-R26E
AMC 433275	ROCKSTAR 876	2015-4540	SEC27-T06S-R26E
AMC 433276	ROCKSTAR 877	2015-4541	SEC27-T06S-R26E
AMC 433277	ROCKSTAR 878	2015-4542	SEC27-T06S-R26E

RECEIVED  
SECURITY  
DIVISION  
OCT 10 2015

EXHIBIT A

AMC 433278	ROCKSTAR 879	2015-4543	SEC27-T06S-R26E
AMC 433279	ROCKSTAR 880	2015-4544	SEC27-T06S-R26E
AMC 433280	ROCKSTAR 881	2015-4545	SEC27-T06S-R26E
AMC 433281	ROCKSTAR 882	2015-4546	SEC28-T06S-R26E
AMC 433282	ROCKSTAR 883	2015-4547	SEC28-T06S-R26E
AMC 433283	ROCKSTAR 884	2015-4548	SEC28-T06S-R26E
AMC 433284	ROCKSTAR 885	2015-4549	SEC28-T06S-R26E
AMC 433285	ROCKSTAR 886	2015-4550	SEC28-T06S-R26E
AMC 433286	ROCKSTAR 887	2015-4551	SEC28-T06S-R26E
AMC 433287	ROCKSTAR 888	2015-4552	SEC28-T06S-R26E
AMC 433288	ROCKSTAR 889	2015-4553	SEC28-T06S-R26E
AMC 433289	ROCKSTAR 890	2015-4554	SEC28-T06S-R26E
AMC 433290	ROCKSTAR 891	2015-4555	SEC28-T06S-R26E
AMC 433291	ROCKSTAR 892	2015-4556	SEC28-T06S-R26E
AMC 433292	ROCKSTAR 893	2015-4557	SEC28-T06S-R26E
AMC 433293	ROCKSTAR 894	2015-4558	SEC28-T06S-R26E
AMC 433294	ROCKSTAR 895	2015-4559	SEC28-T06S-R26E
AMC 433295	ROCKSTAR 896	2015-4560	SEC28-T06S-R26E
AMC 433296	ROCKSTAR 897	2015-4561	SEC28-T06S-R26E
AMC 433297	ROCKSTAR 898	2015-4562	SEC28-T06S-R26E
AMC 433298	ROCKSTAR 899	2015-4563	SEC28-T06S-R26E
AMC 433299	ROCKSTAR 900	2015-4564	SEC28-T06S-R26E
AMC 433300	ROCKSTAR 901	2015-4565	SEC28-T06S-R26E
AMC 433301	ROCKSTAR 902	2015-4566	SEC28-T06S-R26E
AMC 433302	ROCKSTAR 903	2015-4567	SEC28-T06S-R26E
AMC 433303	ROCKSTAR 904	2015-4568	SEC28-T06S-R26E
AMC 433304	ROCKSTAR 905	2015-4569	SEC28-T06S-R26E
AMC 433305	ROCKSTAR 906	2015-4570	SEC28-T06S-R26E
AMC 433306	ROCKSTAR 907	2015-4571	SEC28-T06S-R26E
AMC 433307	ROCKSTAR 908	2015-4572	SEC28-T06S-R26E
AMC 433308	ROCKSTAR 909	2015-4573	SEC28-T06S-R26E
AMC 433309	ROCKSTAR 910	2015-4574	SEC28-T06S-R26E
AMC 433310	ROCKSTAR 911	2015-4575	SEC29-T06S-R26E
AMC 433311	ROCKSTAR 912	2015-4576	SEC29-T06S-R26E
AMC 433312	ROCKSTAR 913	2015-4577	SEC29-T06S-R26E
AMC 433313	ROCKSTAR 914	2015-4578	SEC29-T06S-R26E
AMC 433314	ROCKSTAR 915	2015-4579	SEC29-T06S-R26E
AMC 433315	ROCKSTAR 916	2015-4580	SEC29-T06S-R26E
AMC 433316	ROCKSTAR 917	2015-4581	SEC29-T06S-R26E
AMC 433317	ROCKSTAR 918	2015-4582	SEC29-T06S-R26E
AMC 433318	ROCKSTAR 919	2015-4583	SEC29-T06S-R26E
AMC 433319	ROCKSTAR 920	2015-4584	SEC29-T06S-R26E
AMC 433320	ROCKSTAR 921	2015-4585	SEC29-T06S-R26E
AMC 433321	ROCKSTAR 922	2015-4586	SEC29-T06S-R26E
AMC 433322	ROCKSTAR 923	2015-4587	SEC29-T06S-R26E
AMC 433323	ROCKSTAR 924	2015-4588	SEC29-T06S-R26E
AMC 433324	ROCKSTAR 925	2015-4589	SEC29-T06S-R26E

RECEIVED  
FBI  
MAY 27 2015  
37  
ICE

EXHIBIT A

AMC 433325	ROCKSTAR 926	2015-4590		SEC29-T06S-R26E
AMC 433326	ROCKSTAR 927	2015-4591		SEC29-T06S-R26E
AMC 433327	ROCKSTAR 928	2015-4592		SEC29-T06S-R26E
AMC 433328	ROCKSTAR 929	2015-4593		SEC30-T06S-R26E
AMC 433329	ROCKSTAR 930	2015-4594		SEC30-T06S-R26E
AMC 433330	ROCKSTAR 931	2015-4595	2017-00416	SEC30-T06S-R26E
AMC 433331	ROCKSTAR 932	2015-4596	2017-00417	SEC30-T06S-R26E
AMC 433332	ROCKSTAR 933	2015-4597	2017-00418	SEC30-T06S-R26E
AMC 433333	ROCKSTAR 934	2015-4598	2017-00419	SEC30-T06S-R26E
AMC 433334	ROCKSTAR 935	2015-4599	2017-00420	SEC30-T06S-R26E
AMC 433335	ROCKSTAR 936	2015-4600	2017-00421	SEC30-T06S-R26E
AMC 433336	ROCKSTAR 937	2015-4601	2017-00422	SEC30-T06S-R26E
AMC 433337	ROCKSTAR 938	2015-4602	2017-00423	SEC31-T06S-R26E
AMC 433338	ROCKSTAR 939	2015-4603		SEC30-T06S-R26E
AMC 433339	ROCKSTAR 940	2015-4604		SEC30-T06S-R26E
AMC 433340	ROCKSTAR 941	2015-4605		SEC30-T06S-R26E
AMC 433341	ROCKSTAR 942	2015-4606		SEC30-T06S-R26E
AMC 433342	ROCKSTAR 943	2015-4607		SEC30-T06S-R26E
AMC 433343	ROCKSTAR 944	2015-4608	2017-00424	SEC30-T06S-R26E
AMC 433344	ROCKSTAR 945	2015-4609		SEC30-T06S-R26E
AMC 433345	ROCKSTAR 946	2015-4610		SEC30-T06S-R26E
AMC 433346	ROCKSTAR 947	2015-4611		SEC30-T06S-R26E
AMC 433347	ROCKSTAR 948	2015-4612		SEC30-T06S-R26E
AMC 433348	ROCKSTAR 949	2015-4613	2017-00588	SEC30-T06S-R26E
AMC 433349	ROCKSTAR 950	2015-4614		SEC30-T06S-R26E
AMC 433350	ROCKSTAR 951	2015-4615		SEC30-T06S-R26E
AMC 433351	ROCKSTAR 952	2015-4616		SEC30-T06S-R26E
AMC 433352	ROCKSTAR 953	2015-4617		SEC30-T06S-R26E
AMC 433353	ROCKSTAR 954	2015-4618		SEC30-T06S-R26E
AMC 433354	ROCKSTAR 955	2015-4619	2017-00426	SEC31-T06S-R26E
AMC 433355	ROCKSTAR 956	2015-4620		SEC31-T06S-R26E
AMC 433356	ROCKSTAR 957	2015-4621		SEC31-T06S-R26E
AMC 433357	ROCKSTAR 958	2015-4622		SEC32-T06S-R26E
AMC 433358	ROCKSTAR 959	2015-4623		SEC32-T06S-R26E
AMC 433359	ROCKSTAR 960	2015-4624		SEC31-T06S-R26E
AMC 433360	ROCKSTAR 961	2015-4625		SEC31-T06S-R26E
AMC 433361	ROCKSTAR 962	2015-4626		SEC31-T06S-R26E
AMC 433362	ROCKSTAR 963	2015-4627		SEC31-T06S-R26E
AMC 433363	ROCKSTAR 964	2015-4628		SEC31-T06S-R26E
AMC 433364	ROCKSTAR 965	2015-4629		SEC31-T06S-R26E
AMC 433365	ROCKSTAR 966	2015-4630		SEC31-T06S-R26E
AMC 433366	ROCKSTAR 967	2015-4631		SEC31-T06S-R26E
AMC 433367	ROCKSTAR 968	2015-4632		SEC31-T06S-R26E
AMC 433368	ROCKSTAR 969	2015-4633		SEC31-T06S-R26E
AMC 433369	ROCKSTAR 970	2015-4634		SEC31-T06S-R26E
AMC 433370	ROCKSTAR 971	2015-4635		SEC31-T06S-R26E
AMC 433371	ROCKSTAR 973	2015-4636		SEC31-T06S-R26E

PHOENIX, ARIZONA  
 JUN 12 2017  
 12:37

EXHIBIT A

AMC 433372	ROCKSTAR 974	2015-4637	SEC32-T06S-R26E
AMC 433373	ROCKSTAR 975	2015-4638	SEC31-T06S-R26E
AMC 433374	ROCKSTAR 976	2015-4639	SEC31-T06S-R26E
AMC 433375	ROCKSTAR 977	2015-4640	SEC32-T06S-R26E
AMC 433376	ROCKSTAR 978	2015-4641	SEC32-T06S-R26E
AMC 433377	ROCKSTAR 979	2015-4642	SEC32-T06S-R26E
AMC 433378	ROCKSTAR 980	2015-4643	SEC32-T06S-R26E
AMC 433379	ROCKSTAR 981	2015-4644	SEC32-T06S-R26E
AMC 433380	ROCKSTAR 982	2015-4645	SEC32-T06S-R26E
AMC 433381	ROCKSTAR 983	2015-4646	SEC32-T06S-R26E
AMC 433382	ROCKSTAR 984	2015-4647	SEC32-T06S-R26E
AMC 433383	ROCKSTAR 985	2015-4648	SEC32-T06S-R26E
AMC 433384	ROCKSTAR 986	2015-4649	SEC32-T06S-R26E
AMC 433385	ROCKSTAR 987	2015-4650	SEC32-T06S-R26E
AMC 433386	ROCKSTAR 988	2015-4651	SEC32-T06S-R26E
AMC 433387	ROCKSTAR 989	2015-4652	SEC32-T06S-R26E
AMC 433388	ROCKSTAR 990	2015-4653	SEC32-T06S-R26E
AMC 433389	ROCKSTAR 991	2015-4654	SEC33-T06S-R26E
AMC 433390	ROCKSTAR 992	2015-4655	SEC33-T06S-R26E
AMC 433391	ROCKSTAR 993	2015-4656	SEC33-T06S-R26E
AMC 433392	ROCKSTAR 994	2015-4657	SEC33-T06S-R26E
AMC 433393	ROCKSTAR 995	2015-4658	SEC33-T06S-R26E
AMC 433394	ROCKSTAR 996	2015-4659	SEC33-T06S-R26E
AMC 433395	ROCKSTAR 997	2015-4660	SEC33-T06S-R26E
AMC 433396	ROCKSTAR 998	2015-4661	SEC33-T06S-R26E
AMC 433397	ROCKSTAR 999	2015-4662	SEC33-T06S-R26E
AMC 433398	ROCKSTAR 1000	2015-4663	SEC33-T06S-R26E
AMC 433399	ROCKSTAR 1001	2015-4664	SEC33-T06S-R26E
AMC 433400	ROCKSTAR 1002	2015-4665	SEC33-T06S-R26E
AMC 433401	ROCKSTAR 1003	2015-4666	SEC32-T06S-R26E
AMC 433402	ROCKSTAR 1004	2015-4667	SEC32-T06S-R26E
AMC 433403	ROCKSTAR 1005	2015-4668	SEC32-T06S-R26E
AMC 433404	ROCKSTAR 1006	2015-4669	SEC33-T06S-R26E
AMC 433405	ROCKSTAR 1007	2015-4670	SEC33-T06S-R26E
AMC 433406	ROCKSTAR 1008	2015-4671	SEC28-T06S-R26E
AMC 433439	Red Bull-681	2015-4746	SEC22-T05S-R26E
AMC 433440	Red Bull-682	2015-4747	SEC22-T05S-R26E
AMC 433441	Red Bull-683	2015-4748	SEC22-T05S-R26E
AMC 433442	Red Bull-684	2015-4749	SEC22-T05S-R26E
AMC 433443	Red Bull-685	2015-4750	SEC22-T05S-R26E
AMC 433444	Red Bull-686	2015-4751	SEC22-T05S-R26E
AMC 433448	Red Bull-690	2015-4755	SEC22-T05S-R26E
AMC 433449	Red Bull-691	2015-4756	SEC22-T05S-R26E
AMC 433450	Red Bull-692	2015-4757	SEC22-T05S-R26E
AMC 433451	Red Bull-693	2015-4758	SEC22-T05S-R26E
AMC 433452	Red Bull-694	2015-4759	SEC22-T05S-R26E
AMC 433453	Red Bull-695	2015-4760	SEC22-T05S-R26E

NO  
INDEX  
ARIZONA  
11/37

EXHIBIT A

AMC 433457	Red Bull-699	2015-4764	SEC09-T05S-R26E
AMC 433458	Red Bull-700	2015-4765	SEC09-T05S-R26E
AMC 433469	Red Bull-711	2015-4776	SEC09-T05S-R26E
AMC 433470	Red Bull-712	2015-4777	SEC09-T05S-R26E
AMC 433471	Red Bull-713	2015-4778	SEC09-T05S-R26E
AMC 433472	Red Bull-714	2015-4779	SEC09-T05S-R26E
AMC 433473	Red Bull-715	2015-4780	SEC09-T05S-R26E
AMC 433474	Red Bull-716	2015-4781	SEC09-T05S-R26E
AMC 433475	Red Bull-717	2015-4782	SEC09-T05S-R26E
AMC 433476	Red Bull-718	2015-4783	SEC09-T05S-R26E
AMC 433477	Red Bull-719	2015-4784	SEC09-T05S-R26E
AMC 433478	Red Bull-720	2015-4785	SEC09-T05S-R26E
AMC 433479	Red Bull-721	2015-4786	SEC09-T05S-R26E
AMC 433480	Red Bull-722	2015-4787	SEC09-T05S-R26E
AMC 433481	Red Bull-723	2015-4788	SEC09-T05S-R26E
AMC 433482	Red Bull-724	2015-4789	SEC09-T05S-R26E
AMC 433483	Red Bull-725	2015-4790	SEC09-T05S-R26E
AMC 433484	Red Bull-726	2015-4791	SEC09-T05S-R26E
AMC 433485	Red Bull-727	2015-4792	SEC09-T05S-R26E
AMC 433486	Red Bull-728	2015-4793	SEC09-T05S-R26E
AMC 433487	Red Bull-729	2015-4794	SEC09-T05S-R26E
AMC 433488	Red Bull-730	2015-4795	SEC09-T05S-R26E
AMC 433489	Red Bull-731	2015-4796	SEC09-T05S-R26E
AMC 433490	Red Bull-732	2015-4797	SEC09-T05S-R26E
AMC 433491	Red Bull-733	2015-4798	SEC09-T05S-R26E
AMC 433492	Red Bull-734	2015-4799	SEC04-T05S-R26E
AMC 433493	Red Bull-735	2015-4800	SEC04-T05S-R26E
AMC 433494	Red Bull-736	2015-4801	SEC04-T05S-R26E
AMC 433495	Red Bull-737	2015-4802	SEC05-T05S-R26E
AMC 433496	Red Bull-738	2015-4803	SEC05-T05S-R26E
AMC 433497	Red Bull-739	2015-4804	SEC05-T05S-R26E
AMC 441072	ROCKSTAR 931B	2017-00427	SEC30-T06S-R26E
AMC 441073	ROCKSTAR 937A	2017-00428	SEC31-T06S-R26E
AMC 441074	ROCKSTAR 931A	2017-00429	SEC30-T06S-R26E
AMC 441075	ROCKSTAR 932B	2017-00430	SEC30-T06S-R26E
AMC 441076	ROCKSTAR 933B	2017-00431	SEC30-T06S-R26E
AMC 441077	ROCKSTAR 934B	2017-00432	SEC30-T06S-R26E
AMC 441078	ROCKSTAR 935B	2017-00433	SEC30-T06S-R26E
AMC 441079	ROCKSTAR 936B	2017-00434	SEC30-T06S-R26E
AMC 441080	ROCKSTAR 937B	2017-00435	SEC30-T06S-R26E
AMC 441081	ROCKSTAR 938B	2017-00436	SEC30-T06S-R26E
AMC 441082	ROCKSTAR 944B	2017-00437	SEC30-T06S-R26E
AMC 441083	ROCKSTAR 949B	2017-00438	SEC30-T06S-R26E
AMC 441084	ROCKSTAR 955B	2017-00439	SEC30-T06S-R26E
<b>Claim Total</b>		<b>3,284</b>	

RECEIVED  
 DEMAND STATE OFFICE  
 APR 10 2017  
 10:37  
 ARIZONA

**United States Department of the Interior**  
**Bureau of Land Management**  
 DIV OF LANDS, MINRLS & ENERGY  
 ONE N CENTRAL AVE  
 PHOENIX, AZ 85004 -4427  
 Phone: 602-417-9200

Receipt

No: 4041425

<b>Transaction #:</b> 4152664	
<b>Date of Transaction:</b> 12/13/2017	
<b>CUSTOMER:</b>	
FREEPORT MCMORAN INC 333 N CENTRAL AVE PHOENIX, AZ 85004-2121 US	

LINE #	QTY	DESCRIPTION	REMARKS	UNIT PRICE	TOTAL
1	1.00	LOCATABLE MINERALS / MINING CLAIMS- NOT NEW-UNADJUD, ONE AUTH NO. ONLY / MINING CLAIM MONEY RECEIVED <b>CASES: AMC46468/\$32840.00</b>	TRF/3284	- n/a -	32840.00
<b>TOTAL:</b>					<b>\$32,840.00</b>

PAYMENT INFORMATION			
1	AMOUNT:	32840.00	POSTMARKED: N/A
	TYPE:	CHECK	RECEIVED: 12/12/2017
	CHECK NO:	8888086	
	NAME:	FREEPORT MCMORAN INC 333 N CENTRAL AVE PHOENIX AZ 85004-2121 US	

REMARKS

This receipt was generated by the automated BLM Collections and Billing System and is a paper representation of a portion of the official electronic record contained therein.

431317  
432120  
433439

Southwest Exploration Group LLC  
580 S. Prospectors Road  
Apache Junction, AZ 85119

October 4, 2016

Arizona State Office  
Bureau of Land Management  
One N Central Ave, Suite 800  
Phoenix AZ 85004-4427

Dear Arizona State Office Personnel,

Enclosed is paperwork filed with the Graham County Recorder in which Freeport Minerals Corporation has quit claimed 88 unpatented mining claims to Southwest Exploration Group LLC. A check for \$880.00 is also enclosed for fees to transfer these claims to Southwest Exploration Group LLC.

Best regards,

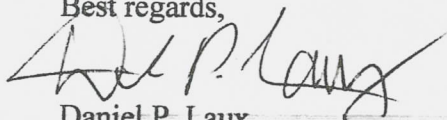

Daniel P. Laux  
Member  
Southwest Exploration Group LLC

RECEIVED  
BLM AT STATE OFFICE  
2016 OCT -5 P 3:15  
PHOENIX, ARIZONA



**QUIT CLAIM DEED**

Upon recording return to:  
Southwest Exploration Group LLC  
580 S. Prospectors Rd  
Apache Junction, Arizona 85119

Affidavit of Value exempt pursuant to A.R.S § 11-1134(A)(6)

---

**QUIT CLAIM DEED**  
**(Unpatented Mining Claims)**

For Ten Dollars (\$10.00) and other good and valuable consideration, the receipt and sufficiency of which is hereby acknowledged, **FREEPORT MINERALS CORPORATION**, a Delaware Corporation ("Grantor"), hereby quit-claim and release, to **SOUTHWEST EXPLORATION GROUP LLC**, an Arizona limited liability company, all right, title or interest, if any, in the eighty eight (88) unpatented lode mining claims situated in the Lone Star Mining District, Graham County, Arizona (the "Claims") described on Exhibit "A" attached hereto.

[SIGNATURES ON FOLLOWING PAGE]

RECEIVED  
BLM AZ STATE OFFICE  
2016 OCT -5 P 3 15  
PHOENIX, ARIZONA

IN WITNESS WHEREOF, Grantor has executed this Quit Claim Deed as of this 30<sup>TH</sup> day of AUGUST, 2016

GRANTOR:

**FREEPORT MINERALS CORPORATION**, a Delaware corporation

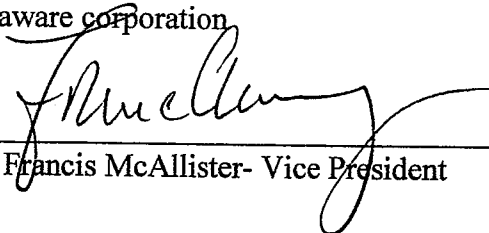
  
By: Francis McAllister- Vice President

STATE OF ARIZONA )  
County of MARICOPA ) SS.

The foregoing Quit Claim Deed dated the 30<sup>TH</sup> day of AUGUST, 2016, granted for the benefit of Southwest Exploration Group LLC, an Arizona limited liability company, consisting of a total of 5 pages, was acknowledged before me this 30<sup>TH</sup> day of AUGUST, 2016 by Francis McAllister as Vice President of Freeport Minerals Corporation, a Delaware corporation.

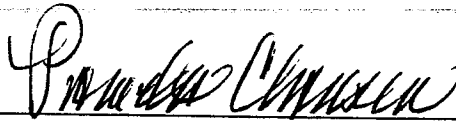

  
Notary Public

My commission expires: JANUARY 30, 2017

STATE OF \_\_\_\_\_ )  
County of \_\_\_\_\_ ) SS.

RECEIVED  
BLM AZ STATE OFFICE  
2016 OCT - 5 P 3:15  
PHOENIX, ARIZONA

## EXHIBIT "A"

County : Graham		
State : AZ		
	Claim Name	BLM Serial Number
1	RB 423	AMC 431532
2	RB 424	AMC 431533
3	RB 425	AMC 431534
4	RB 426	AMC 431535
5	RB 427	AMC 431536
6	RB 428	AMC 431537
7	RB 429	AMC 431538
8	RB 430	AMC 431539
9	RB 431	AMC 431540
10	RB 432	AMC 431541
11	RB 465	AMC 432170
12	RB 466	AMC 432171
13	RB 467	AMC 432172
14	RB 468	AMC 432173
15	RB 687	AMC 433445
16	RB 688	AMC 433446
17	RB 689	AMC 433447
18	RB 696	AMC 433454
19	RB 701	AMC 433459
20	RB 702	AMC 433460
21	RB 703	AMC 433461
22	RB 704	AMC 433462
23	RB 710	AMC 433468
24	RB 415	AMC 431524
25	RB 416	AMC 431525
26	RB 417	AMC 431526
27	RB 418	AMC 431527
28	RB 419	AMC 431528
29	RB 420	AMC 431529
30	RB 421	AMC 431530
31	RB 422	AMC 431531
32	RB 433	AMC 432138
33	RB 434	AMC 432139
34	RB 435	AMC 432140
35	RB 436	AMC 432141
36	RB 437	AMC 432142
37	RB 438	AMC 432143
38	RB 439	AMC 432144

RECEIVED  
 BLM ARIZONA  
 OFFICE  
 3 15

39	RB 440	AMC 432145
40	RB 441	AMC 432146
41	RB 442	AMC 432147
42	RB 443	AMC 432148
43	RB 444	AMC 432149
44	RB 445	AMC 432150
45	RB 446	AMC 432151
46	RB 447	AMC 432152
47	RB 448	AMC 432153
48	RB 449	AMC 432154
49	RB 450	AMC 432155
50	RB 451	AMC 432156
51	RB 452	AMC 432157
52	RB 453	AMC 432158
53	RB 454	AMC 432159
54	RB 455	AMC 432160
55	RB 456	AMC 432161
56	RB 457	AMC 432162
57	RB 458	AMC 432163
58	RB 459	AMC 432164
59	RB 460	AMC 432165
60	RB 461	AMC 432166
61	RB 462	AMC 432167
62	RB 463	AMC 432168
63	RB 464	AMC 432169
64	RB 697	AMC 433455
65	RB 698	AMC 433456
66	RB 705	AMC 433463
67	RB 706	AMC 433464
68	RB 707	AMC 433465
69	RB 708	AMC 433466
70	RB 709	AMC 433467
71	RB 397	AMC 431506
72	RB 398	AMC 431507
73	RB 399	AMC 431508
74	RB 400	AMC 431509
75	RB 401	AMC 431510
76	RB 402	AMC 431511
77	RB 403	AMC 431512
78	RB 404	AMC 431513
79	RB 405	AMC 431514
80	RB 406	AMC 431515
81	RB 407	AMC 431516

RECEIVED  
 PHOENIX, ARIZONA

82	RB 408	AMC 431517
83	RB 409	AMC 431518
84	RB 410	AMC 431519
85	RB 411	AMC 431520
86	RB 412	AMC 431521
87	RB 413	AMC 431522
88	RB 414	AMC 431523

RECEIVED  
BLM AZ STATE OFFICE  
2016 OCT -5 P 3:16  
PHOENIX, ARIZONA

**United States Department of the Interior  
Bureau of Land Management**

DIV OF LANDS, MINRLS & ENERGY  
ONE N CENTRAL AVE  
PHOENIX, AZ 85004 -4427  
Phone: 602-417-9200

Receipt

No: 3673373

<b>Transaction #:</b> 3777701	
<b>Date of Transaction:</b> 10/06/2016	
<b>CUSTOMER:</b>	
SOUTHWEST EXPLORATION GROUP LLC 580 S PROSPECTORS RD APACHE JUNCTION, AZ 85119-8828 US	

LINE #	QTY	DESCRIPTION	REMARKS	UNIT PRICE	TOTAL
1	1.00	LOCATABLE MINERALS / MINING CLAIMS- NOT NEW-UNADJUD, ONE AUTH NO. ONLY / MINING CLAIM MONEY RECEIVED CASES: AMC431532/\$880.00	QCD - 88	- n/a -	880.00
<b>TOTAL:</b>					<b>\$880.00</b>

PAYMENT INFORMATION			
1	AMOUNT:	880.00	POSTMARKED: 10/04/2016
	TYPE:	CHECK	RECEIVED: 10/05/2016
	CHECK NO:	0000864148	
	NAME:	FREEPORT MCMORAN 333 N CENTRAL AVE PHOENIX AZ 85004 US	

REMARKS

This receipt was generated by the automated BLM Collections and Billing System and is a paper representation of a portion of the official electronic record contained therein.

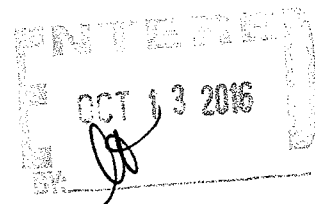

Southwest Exploration Group LLC  
580 S Prospectors Rd  
Apache Jct, AZ 85119

RECEIVED  
BLM AZ STATE OFFICE

2016 OCT -5 P 3:15

PHOENIX, ARIZONA

Bureau of Land Management  
One N Central Ave, Suite 800  
Phoenix AZ 85004-4427

**PRIORITY<sup>®</sup>**  
**★ MAIL ★**

**FLAT RATE ENVELOPE**  
ONE RATE ★ ANY WEIGHT\*

APPLY PRIORITY MAIL POSTAGE HERE

1 N CENTRAL AVE STE 800  
PHOENIX AZ 85004-4427

**USPS TRACKING NUMBER**



9505 5000 1027 6278 0002 70

\* For international shipments, the maximum weight is 4 lbs.

EP14H July 2013 Outer Dimension: 10 x 5



\* Domestic only.



PRESS FIRMLY TO SEAL

RECEIVED  
BLM AZ STATE OFFICE  
2016 OCT -5 P 3:15  
PHOENIX, ARIZONA



EP14H July 2013  
OD: 10 x 5



PS00001000064

This packaging is the property of the U.S. Postal Service® and is provided solely for use in sending Priority Mail® shipments. Misuse may be a violation of federal law. This packaging is not for resale.

VELOPE  
EIGHT\*

0021

TO:  
SHIP

EXPECTED DELIVERY 10/05/2016

PRIORITY MAIL 1-DAY™

U.S. POSTAGE  
\$6.45  
PM 1-DAY  
86120 0021  
Date of sale  
10/04/16  
10/04/16  
2500  
SIX  
08310267



P

★ MAIL ★

- DATE OF DELIVERY SPECIFIED\*
- USPS TRACKING™ INCLUDED\*
- INSURANCE INCLUDED\*
- PICKUP AVAILABLE

\* Domestic only

VISIT US AT USPS.COM®  
ORDER FREE SUPPLIES ONLINE

Postal Service; July 2013; All rights reserved.

**NOTICE!!**

**These documents have been scanned!**

**Do not place un-scanned documents beneath this notice!**

**Do not remove this notice from this file!**

GPO Jacket No. 560-102  
Print Order 61540  
Rise Business Services, LLC  
Job=AZ15 5/8/2019



Box Number= AZ15026



Claim Begin-End: AMC432120-AMC432235

4 Annual Filings



AZ15026-5 AMC431791-AMC432478



# United States Department of the Interior



BUREAU OF LAND MANAGEMENT

Arizona State Office

One North Central Avenue, Suite 800

Phoenix, Arizona 85004-4427

[www.blm.gov/az/](http://www.blm.gov/az/)

OCT 21 2020

In Reply Refer To:

3800 (9200) RM

AMC66892, AMC294150, AMC298861, AMC340956, AMC431121, AMC431566,  
AMC431611, AMC431791, AMC431904, AMC432120, AMC432241, AMC432443,  
AMC432486, AMC432621, AMC432994

CERTIFIED MAIL - RETURN RECEIPT REQUESTED No. 9214 8901 9403 8323 3302 75

## DECISION

FREEPORT MCMORAN SAFFORD INC : This decision affects those claims  
PO BOX 1019 : shown on the attached list(s).  
SAFFORD, AZ 85548-1019 :

---

SEE ATTACHMENT(S) FOR CLAIM NAMES AND AMC NUMBERS

---

## MINING CLAIMS DECLARED FORFEITED

The mining claims listed above have been declared forfeited as of September 1, 2020, for failure to timely file the required maintenance fee payment or small miner's maintenance fee waiver (waiver).

Claimants are required to pay an annual non-refundable maintenance fee of \$165 per 20 acres or portion thereof, or submit a waiver, on or before September 1 of each year. These requirements were established by 30 U.S.C. 28f-1, as amended, and 43 CFR 3834 and 3835.

Our records do not show receipt of a maintenance fee payment or small miner waiver filed on or before the due date. Therefore, the claims listed above are forfeited.

## Reclamation Requirements

This decision does not relieve you of the liability for reclamation of all areas disturbed by your activities on lands covered by the subject mining claim(s) and/or site(s). After you complete the reclamation, you must notify the authorized officer of the appropriate surface managing agency so that the authorized officer may conduct a final site inspection and determine whether you may



be released from liability. If you fail to reclaim the land to the satisfaction of the authorized officer, the surface management agency may cite you for noncompliance under its surface management regulations. For land administered by the Bureau of Land Management (BLM), if you fail to reclaim the land to the satisfaction of the authorized officer as required in 43 CFR Subpart 3809, the BLM will issue an order of noncompliance under 43CFR 3809.601(a). If you fail to comply with the non-compliance order, BLM may take further action under 43 CFR 3809.604. Failure to conduct reclamation is a prohibited act that may subject you to criminal penalties. See 43 CFR 3809.605(h) and 43 CFR 3809.700.

### Appeal Procedures

This decision may be appealed to the Interior Board of Land Appeals, Office of the Secretary, in accordance with the regulations contained in 43 CFR, Part 4, and the enclosed Form 1842-1. If an appeal is taken, your notice of appeal must be filed in this office (at the above address) within 30 days from receipt of this decision. The appellant has the burden of showing that the decision appealed from is in error.

If you wish to file a petition pursuant to regulation 43 CFR 4.21 (58 FR 4939, January 19, 1993) for a stay of the effectiveness of this decision during the time that your appeal is being reviewed by the Board, the petition for a stay must accompany your notice of appeal. A petition for a stay is required to show sufficient justification based on the standards listed below. Copies of the notice of appeal and petition for a stay **must** also be submitted to each party named in this decision and to the Interior Board of Land Appeals and to the appropriate Office of the Solicitor (see 43 CFR 4.413) at the same time the original documents are filed with this office. If you request a stay, you have the burden of proof to demonstrate that a stay should be granted.

### Standards for Obtaining a Stay

Except as otherwise provided by law or other pertinent regulation, a petition for a stay of a decision pending appeal shall show sufficient justification based on the following standards:

- (1) The relative harm to the parties if the stay is granted or denied,
- (2) The likelihood of the appellant's success on the merits,
- (3) The likelihood of immediate and irreparable harm if the stay is not granted, and
- (4) Whether the public interest favors granting the stay.

Please include your AMC serial number(s) on all correspondence. If additional information is required, please call RéAnn Myers at 602-417-9413.

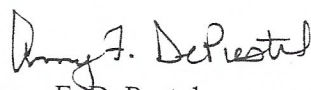
  
Amy F. DePestel  
Supervisory Land Law Examiner  
Lands, Minerals and Energy Division

Enclosure(s)

FREEPORT MCMORAN SAFFORD INC

PO BOX 1019

SAFFORD AZ 85548-1019

<u>LEAD FILE NUMBER</u>	<u>CLAIM NUMBER</u>	<u>CLAIM NAME</u>
AMC66892	AMC67731	MAS NO 91
AMC66892	AMC67732	MAS NO 92
AMC66892	AMC67733	MAS NO 93
AMC66892	AMC67734	MAS NO 94
AMC66892	AMC67735	MAS NO 96
AMC66892	AMC67736	MAS NO 98
AMC66892	AMC67737	MAS NO 100
AMC294150	AMC294192	AZCO #300
AMC294150	AMC294193	AZCO #301
AMC294150	AMC294194	AZCO #302
AMC294150	AMC294195	AZCO #303
AMC294150	AMC294196	AZCO #304
AMC294150	AMC294197	AZCO #305
AMC294150	AMC294198	AZCO #306
AMC298861	AMC298861	AZCO NO 44
AMC298861	AMC298862	AZCO NO 45
AMC298861	AMC298868	AZCO NO 400
AMC298861	AMC298870	AZCO NO 402
AMC298861	AMC298876	AZCO NO 410
AMC340956	AMC341001	SG 46
AMC431121	AMC431172	MONSTER-052
AMC431121	AMC431173	MONSTER-053
AMC431121	AMC431179	MONSTER-059
AMC431121	AMC431180	MONSTER-060
AMC431121	AMC431181	MONSTER-061
AMC431121	AMC431182	MONSTER-062
AMC431121	AMC431187	MONSTER-067
AMC431121	AMC431188	MONSTER-068
AMC431121	AMC431189	MONSTER-069
AMC431121	AMC431190	MONSTER-070
AMC431121	AMC431195	MONSTER-075
AMC431121	AMC431196	MONSTER-076
AMC431121	AMC431197	MONSTER-077

AMC431121	AMC431198	MONSTER-078
AMC431121	AMC431203	MONSTER-083
AMC431121	AMC431206	MONSTER-086
AMC431121	AMC431207	MONSTER-087
AMC431121	AMC431210	MONSTER-090
AMC431121	AMC431211	MONSTER-091
AMC431121	AMC431212	MONSTER-092
AMC431121	AMC431213	MONSTER-093
AMC431121	AMC431214	MONSTER-094
AMC431121	AMC431215	MONSTER-095
AMC431121	AMC431218	MONSTER-098
AMC431121	AMC431219	MONSTER-099
AMC431121	AMC431220	MONSTER-100
AMC431121	AMC431221	MONSTER-101
AMC431121	AMC431222	MONSTER-102
AMC431121	AMC431223	MONSTER-103
AMC431121	AMC431226	MONSTER-106
AMC431121	AMC431227	MONSTER-107
AMC431121	AMC431228	MONSTER-108
AMC431121	AMC431281	MONSTER-363
AMC431566	AMC431566	ROCKSTAR 173
AMC431566	AMC431567	ROCKSTAR 174
AMC431566	AMC431568	ROCKSTAR 175
AMC431566	AMC431569	ROCKSTAR 176
AMC431566	AMC431570	ROCKSTAR 177
AMC431566	AMC431571	ROCKSTAR 178
AMC431566	AMC431574	ROCKSTAR 181
AMC431566	AMC431575	ROCKSTAR 182
AMC431566	AMC431600	ROCKSTAR 207
AMC431566	AMC431601	ROCKSTAR 208
AMC431566	AMC431602	ROCKSTAR 209
AMC431611	AMC431648	ROCKSTAR 248
AMC431611	AMC431649	ROCKSTAR 249
AMC431611	AMC431661	ROCKSTAR 261
AMC431611	AMC431662	ROCKSTAR 262
AMC431611	AMC431663	ROCKSTAR 263
AMC431791	AMC431791	MONSTER-224
AMC431791	AMC431792	MONSTER-225
AMC431791	AMC431793	MONSTER-226



AMC431791	AMC431794	MONSTER-227
AMC431791	AMC431795	MONSTER-228
AMC431791	AMC431796	MONSTER-229
AMC431791	AMC431797	MONSTER-230
AMC431791	AMC431798	MONSTER-231
AMC431791	AMC431799	MONSTER-232
AMC431791	AMC431800	MONSTER-233
AMC431791	AMC431801	MONSTER-234
AMC431791	AMC431802	MONSTER-235
AMC431791	AMC431803	MONSTER-236
AMC431791	AMC431804	MONSTER-237
AMC431791	AMC431805	MONSTER-238
AMC431791	AMC431806	MONSTER-239
AMC431791	AMC431807	MONSTER-240
AMC431791	AMC431808	MONSTER-241
AMC431791	AMC431809	MONSTER-242
AMC431791	AMC431810	MONSTER-243
AMC431791	AMC431811	MONSTER-244
AMC431791	AMC431812	MONSTER-245
AMC431791	AMC431813	MONSTER-246
AMC431791	AMC431814	MONSTER-247
AMC431791	AMC431815	MONSTER-248
AMC431791	AMC431816	MONSTER-249
AMC431791	AMC431817	MONSTER-250
AMC431791	AMC431818	MONSTER-251
AMC431791	AMC431819	MONSTER-252
AMC431791	AMC431820	MONSTER-253
AMC431791	AMC431821	MONSTER-254
AMC431791	AMC431822	MONSTER-255
AMC431791	AMC431823	MONSTER-256
AMC431791	AMC431824	MONSTER-257
AMC431791	AMC431825	MONSTER-258
AMC431791	AMC431826	MONSTER-259
AMC431791	AMC431827	MONSTER-260
AMC431791	AMC431828	MONSTER-261
AMC431791	AMC431829	MONSTER-262
AMC431791	AMC431830	MONSTER-263
AMC431791	AMC431831	MONSTER-264
AMC431791	AMC431832	MONSTER-265

AMC431791	AMC431833	MONSTER-266
AMC431791	AMC431834	MONSTER-267
AMC431791	AMC431835	MONSTER-268
AMC431791	AMC431836	MONSTER-269
AMC431791	AMC431837	MONSTER-270
AMC431791	AMC431838	MONSTER-271
AMC431791	AMC431839	MONSTER-272
AMC431791	AMC431840	MONSTER-277
AMC431791	AMC431841	MONSTER-278
AMC431791	AMC431842	MONSTER-279
AMC431791	AMC431843	MONSTER-280
AMC431791	AMC431844	MONSTER-285
AMC431791	AMC431845	MONSTER-286
AMC431791	AMC431846	MONSTER-287
AMC431791	AMC431847	MONSTER-288
AMC431791	AMC431848	MONSTER-293
AMC431791	AMC431849	MONSTER-294
AMC431791	AMC431850	MONSTER-421
AMC431791	AMC431851	MONSTER-422
AMC431791	AMC431852	MONSTER-423
AMC431791	AMC431853	MONSTER-424
AMC431791	AMC431854	MONSTER-425
AMC431791	AMC431855	MONSTER-426
AMC431791	AMC431856	MONSTER-427
AMC431791	AMC431857	MONSTER-428
AMC431791	AMC431858	MONSTER-429
AMC431791	AMC431859	MONSTER-430
AMC431791	AMC431860	MONSTER-431
AMC431791	AMC431861	MONSTER-432
AMC431791	AMC431862	MONSTER-433
AMC431791	AMC431863	MONSTER-434
AMC431791	AMC431864	MONSTER-435
AMC431791	AMC431865	MONSTER-436
AMC431791	AMC431866	MONSTER-437
AMC431791	AMC431867	MONSTER-438
AMC431791	AMC431868	MONSTER-439
AMC431791	AMC431869	MONSTER-440
AMC431791	AMC431870	MONSTER-441
AMC431791	AMC431871	MONSTER-442



AMC431791	AMC431872	MONSTER-443
AMC431791	AMC431873	MONSTER-444
AMC431791	AMC431874	MONSTER-445
AMC431791	AMC431875	MONSTER-446
AMC431791	AMC431876	MONSTER-447
AMC431791	AMC431877	MONSTER-448
AMC431791	AMC431878	MONSTER-449
AMC431791	AMC431879	MONSTER-450
AMC431791	AMC431880	MONSTER-451
AMC431791	AMC431881	MONSTER-452
AMC431791	AMC431882	MONSTER-453
AMC431791	AMC431883	MONSTER-454
AMC431791	AMC431884	MONSTER-455
AMC431791	AMC431885	MONSTER-456
AMC431791	AMC431886	MONSTER-457
AMC431791	AMC431887	MONSTER-458
AMC431791	AMC431888	MONSTER-459
AMC431791	AMC431889	MONSTER-460
AMC431791	AMC431890	MONSTER-461
AMC431791	AMC431891	MONSTER-462
AMC431791	AMC431892	MONSTER-463
AMC431791	AMC431893	MONSTER-464
AMC431791	AMC431894	MONSTER-465
AMC431791	AMC431895	MONSTER-466
AMC431791	AMC431896	MONSTER-467
AMC431791	AMC431897	MONSTER-468
AMC431791	AMC431898	MONSTER-469
AMC431791	AMC431899	MONSTER-470
AMC431791	AMC431900	MONSTER-471
AMC431791	AMC431901	MONSTER-472
AMC431791	AMC431902	MONSTER-473
AMC431791	AMC431903	MONSTER-474
AMC431904	AMC431904	MONSTER-109
AMC431904	AMC431905	MONSTER-110
AMC431904	AMC431906	MONSTER-111
AMC431904	AMC431908	MONSTER-113
AMC431904	AMC431909	MONSTER-114
AMC431904	AMC431910	MONSTER-115
AMC431904	AMC431911	MONSTER-116

AMC431904	AMC431912	MONSTER-117
AMC431904	AMC431913	MONSTER-118
AMC431904	AMC431914	MONSTER-119
AMC431904	AMC431915	MONSTER-120
AMC431904	AMC431916	MONSTER-121
AMC431904	AMC431917	MONSTER-122
AMC431904	AMC431918	MONSTER-123
AMC431904	AMC431919	MONSTER-124
AMC431904	AMC431920	MONSTER-125
AMC431904	AMC431921	MONSTER-126
AMC431904	AMC431922	MONSTER-127
AMC431904	AMC431923	MONSTER-128
AMC431904	AMC431924	MONSTER-129
AMC431904	AMC431925	MONSTER-130
AMC431904	AMC431926	MONSTER-131
AMC431904	AMC431927	MONSTER-132
AMC431904	AMC431928	MONSTER-133
AMC431904	AMC431929	MONSTER-134
AMC431904	AMC431930	MONSTER-135
AMC431904	AMC431931	MONSTER-136
AMC431904	AMC431932	MONSTER-137
AMC431904	AMC431933	MONSTER-138
AMC431904	AMC431934	MONSTER-139
AMC431904	AMC431935	MONSTER-140
AMC431904	AMC431936	MONSTER-141
AMC431904	AMC431958	MONSTER-183
AMC431904	AMC431959	MONSTER-184
AMC431904	AMC431969	MONSTER-194
AMC431904	AMC431970	MONSTER-195
AMC431904	AMC431971	MONSTER-196
AMC431904	AMC431972	MONSTER-197
AMC431904	AMC431973	MONSTER-198
AMC431904	AMC431974	MONSTER-199
AMC431904	AMC431975	MONSTER-200
AMC431904	AMC431976	MONSTER-201
AMC431904	AMC431977	MONSTER-202
AMC431904	AMC431978	MONSTER-203
AMC431904	AMC431979	MONSTER-204
AMC431904	AMC431980	MONSTER-205

AMC431904	AMC431981	MONSTER-206
AMC431904	AMC431982	MONSTER-207
AMC431904	AMC431983	MONSTER-208
AMC431904	AMC431984	MONSTER-209
AMC431904	AMC431985	MONSTER-210
AMC431904	AMC431986	MONSTER-211
AMC431904	AMC431987	MONSTER-212
AMC431904	AMC431988	MONSTER-213
AMC431904	AMC431989	MONSTER-214
AMC431904	AMC431990	MONSTER-215
AMC431904	AMC431991	MONSTER-216
AMC431904	AMC431992	MONSTER-217
AMC431904	AMC431993	MONSTER-218
AMC431904	AMC431994	MONSTER-219
AMC431904	AMC431995	MONSTER-220
AMC431904	AMC431996	MONSTER-221
AMC431904	AMC431997	MONSTER-222
AMC431904	AMC431998	MONSTER-223
AMC431904	AMC432011	MONSTER-295
AMC431904	AMC432012	MONSTER-296
AMC431904	AMC432013	MONSTER-297
AMC431904	AMC432014	MONSTER-298
AMC431904	AMC432015	MONSTER-299
AMC431904	AMC432016	MONSTER-300
AMC431904	AMC432017	MONSTER-301
AMC431904	AMC432018	MONSTER-302
AMC431904	AMC432019	MONSTER-303
AMC431904	AMC432020	MONSTER-304
AMC431904	AMC432021	MONSTER-305
AMC431904	AMC432022	MONSTER-306
AMC431904	AMC432023	MONSTER-307
AMC431904	AMC432024	MONSTER-308
AMC431904	AMC432025	MONSTER-309
AMC431904	AMC432026	MONSTER-310
AMC431904	AMC432029	MONSTER-313
AMC431904	AMC432030	MONSTER-314
AMC431904	AMC432031	MONSTER-315
AMC432120	AMC432182	RED BULL-530
AMC432120	AMC432183	RED BULL-531



AMC432120	AMC432184	RED BULL-533
AMC432120	AMC432185	RED BULL-534
AMC432120	AMC432186	RED BULL-536
AMC432120	AMC432187	RED BULL-537
AMC432120	AMC432188	RED BULL-539
AMC432120	AMC432189	RED BULL-540
AMC432120	AMC432190	RED BULL-542
AMC432120	AMC432191	RED BULL-543
AMC432120	AMC432192	RED BULL-545
AMC432120	AMC432193	RED BULL-546
AMC432120	AMC432194	RED BULL-548
AMC432120	AMC432195	RED BULL-549
AMC432120	AMC432196	RED BULL-551
AMC432120	AMC432197	RED BULL-552
AMC432120	AMC432198	RED BULL-554
AMC432120	AMC432199	RED BULL-555
AMC432120	AMC432200	RED BULL-556
AMC432120	AMC432201	RED BULL-557
AMC432120	AMC432202	RED BULL-558
AMC432120	AMC432203	RED BULL-559
AMC432120	AMC432204	RED BULL-560
AMC432120	AMC432205	RED BULL-561
AMC432120	AMC432206	RED BULL-562
AMC432120	AMC432207	RED BULL-563
AMC432120	AMC432208	RED BULL-564
AMC432120	AMC432209	RED BULL-565
AMC432120	AMC432210	RED BULL-566
AMC432120	AMC432211	RED BULL-567
AMC432120	AMC432212	RED BULL-568
AMC432120	AMC432213	RED BULL-569
AMC432120	AMC432214	RED BULL-570
AMC432120	AMC432215	RED BULL-571
AMC432120	AMC432216	RED BULL-572
AMC432120	AMC432217	RED BULL-573
AMC432120	AMC432218	RED BULL-574
AMC432120	AMC432219	RED BULL-575
AMC432120	AMC432220	RED BULL-576
AMC432120	AMC432221	RED BULL-577
AMC432120	AMC432222	RED BULL-578

AMC432120	AMC432223	RED BULL-579
AMC432120	AMC432224	RED BULL-580
AMC432120	AMC432225	RED BULL-581
AMC432120	AMC432226	RED BULL-582
AMC432120	AMC432227	RED BULL-583
AMC432120	AMC432228	RED BULL-584
AMC432120	AMC432229	RED BULL-585
AMC432120	AMC432230	RED BULL-586
AMC432120	AMC432231	RED BULL-587
AMC432120	AMC432232	RED BULL-588
AMC432120	AMC432233	RED BULL-589
AMC432120	AMC432234	RED BULL-590
AMC432120	AMC432235	RED BULL-591
AMC432241	AMC432241	MONSTER-367
AMC432241	AMC432242	MONSTER-368
AMC432241	AMC432243	MONSTER-369
AMC432241	AMC432244	MONSTER-370
AMC432241	AMC432245	MONSTER-371
AMC432241	AMC432246	MONSTER-372
AMC432241	AMC432247	MONSTER-373
AMC432241	AMC432248	MONSTER-374
AMC432241	AMC432249	MONSTER-375
AMC432241	AMC432250	MONSTER-376
AMC432241	AMC432251	MONSTER-377
AMC432241	AMC432254	MONSTER-380
AMC432241	AMC432255	MONSTER-381
AMC432241	AMC432256	MONSTER-382
AMC432241	AMC432257	MONSTER-383
AMC432241	AMC432260	MONSTER-386
AMC432241	AMC432261	MONSTER-387
AMC432241	AMC432262	MONSTER-388
AMC432241	AMC432263	MONSTER-389
AMC432241	AMC432266	MONSTER-392
AMC432241	AMC432267	MONSTER-393
AMC432241	AMC432268	MONSTER-394
AMC432241	AMC432269	MONSTER-395
AMC432241	AMC432272	MONSTER-398
AMC432241	AMC432273	MONSTER-399
AMC432241	AMC432274	MONSTER-400

AMC432241	AMC432275	MONSTER-401
AMC432241	AMC432276	MONSTER-402
AMC432241	AMC432277	MONSTER-403
AMC432241	AMC432278	MONSTER-404
AMC432241	AMC432279	MONSTER-405
AMC432241	AMC432280	MONSTER-406
AMC432241	AMC432281	MONSTER-407
AMC432241	AMC432282	MONSTER-408
AMC432241	AMC432283	MONSTER-409
AMC432241	AMC432284	MONSTER-410
AMC432241	AMC432285	MONSTER-411
AMC432241	AMC432286	MONSTER-412
AMC432241	AMC432287	MONSTER-413
AMC432241	AMC432288	MONSTER-414
AMC432241	AMC432289	MONSTER-415
AMC432241	AMC432290	MONSTER-416
AMC432241	AMC432291	MONSTER-417
AMC432241	AMC432292	MONSTER-418
AMC432241	AMC432293	MONSTER-419
AMC432241	AMC432294	MONSTER-420
AMC432241	AMC432295	MONSTER-475
AMC432241	AMC432296	MONSTER-476
AMC432241	AMC432297	MONSTER-477
AMC432241	AMC432298	MONSTER-478
AMC432241	AMC432299	MONSTER-479
AMC432241	AMC432300	MONSTER-480
AMC432241	AMC432301	MONSTER-481
AMC432241	AMC432302	MONSTER-482
AMC432241	AMC432303	MONSTER-483
AMC432241	AMC432304	MONSTER-484
AMC432241	AMC432305	MONSTER-485
AMC432241	AMC432306	MONSTER-486
AMC432241	AMC432307	MONSTER-487
AMC432241	AMC432308	MONSTER-488
AMC432241	AMC432309	MONSTER-489
AMC432241	AMC432310	MONSTER-490
AMC432241	AMC432311	MONSTER-491
AMC432241	AMC432312	MONSTER-492
AMC432241	AMC432313	MONSTER-493



AMC432241	AMC432314	MONSTER-494
AMC432241	AMC432315	MONSTER-495
AMC432241	AMC432316	MONSTER-496
AMC432241	AMC432317	MONSTER-497
AMC432241	AMC432318	MONSTER-498
AMC432241	AMC432319	MONSTER-499
AMC432241	AMC432320	MONSTER-500
AMC432241	AMC432321	MONSTER-501
AMC432241	AMC432322	MONSTER-502
AMC432241	AMC432323	MONSTER-503
AMC432241	AMC432324	MONSTER-504
AMC432241	AMC432325	MONSTER-505
AMC432241	AMC432326	MONSTER-506
AMC432241	AMC432327	MONSTER-507
AMC432241	AMC432328	MONSTER-508
AMC432241	AMC432329	MONSTER-509
AMC432241	AMC432330	MONSTER-510
AMC432241	AMC432331	MONSTER-511
AMC432241	AMC432332	MONSTER-512
AMC432241	AMC432333	MONSTER-513
AMC432241	AMC432334	MONSTER-514
AMC432241	AMC432335	MONSTER-515
AMC432241	AMC432336	MONSTER-516
AMC432241	AMC432337	MONSTER-517
AMC432241	AMC432338	MONSTER-518
AMC432241	AMC432339	MONSTER-519
AMC432241	AMC432340	MONSTER-520
AMC432241	AMC432341	MONSTER-521
AMC432241	AMC432342	MONSTER-522
AMC432241	AMC432343	MONSTER-523
AMC432241	AMC432344	MONSTER-524
AMC432241	AMC432345	MONSTER-525
AMC432241	AMC432346	MONSTER-526
AMC432241	AMC432347	MONSTER-527
AMC432241	AMC432348	MONSTER-528
AMC432241	AMC432349	MONSTER-529
AMC432241	AMC432350	MONSTER-530
AMC432241	AMC432351	MONSTER-531
AMC432241	AMC432352	MONSTER-532

AMC432241	AMC432353	MONSTER-533
AMC432241	AMC432354	MONSTER-534
AMC432241	AMC432355	MONSTER-535
AMC432241	AMC432356	MONSTER-536
AMC432241	AMC432357	MONSTER-537
AMC432241	AMC432358	MONSTER-538
AMC432241	AMC432359	MONSTER-539
AMC432241	AMC432360	MONSTER-540
AMC432241	AMC432361	MONSTER-541
AMC432241	AMC432362	MONSTER-542
AMC432241	AMC432363	MONSTER-543
AMC432241	AMC432364	MONSTER-544
AMC432241	AMC432365	MONSTER-545
AMC432241	AMC432366	MONSTER-546
AMC432241	AMC432367	MONSTER-547
AMC432241	AMC432368	MONSTER-548
AMC432241	AMC432369	MONSTER-549
AMC432241	AMC432370	MONSTER-550
AMC432241	AMC432371	MONSTER-551
AMC432241	AMC432372	MONSTER-552
AMC432241	AMC432373	MONSTER-553
AMC432241	AMC432374	MONSTER-554
AMC432241	AMC432375	MONSTER-555
AMC432241	AMC432376	MONSTER-556
AMC432241	AMC432377	MONSTER-557
AMC432241	AMC432378	MONSTER-558
AMC432241	AMC432379	MONSTER-559
AMC432241	AMC432380	MONSTER-560
AMC432241	AMC432381	MONSTER-561
AMC432241	AMC432382	MONSTER-562
AMC432241	AMC432383	MONSTER-563
AMC432241	AMC432384	MONSTER-589
AMC432241	AMC432385	MONSTER-590
AMC432241	AMC432386	MONSTER-591
AMC432241	AMC432387	MONSTER-592
AMC432241	AMC432388	MONSTER-593
AMC432241	AMC432389	MONSTER-594
AMC432241	AMC432390	MONSTER-595
AMC432241	AMC432391	MONSTER-596



AMC432241	AMC432392	MONSTER-597
AMC432241	AMC432393	MONSTER-598
AMC432241	AMC432394	MONSTER-599
AMC432241	AMC432395	MONSTER-600
AMC432241	AMC432396	MONSTER-601
AMC432241	AMC432397	MONSTER-602
AMC432241	AMC432398	MONSTER-603
AMC432241	AMC432399	MONSTER-604
AMC432241	AMC432400	MONSTER-605
AMC432241	AMC432401	MONSTER-606
AMC432241	AMC432402	MONSTER-607
AMC432241	AMC432403	MONSTER-608
AMC432241	AMC432404	MONSTER-609
AMC432241	AMC432405	MONSTER-610
AMC432241	AMC432406	MONSTER-611
AMC432241	AMC432407	MONSTER-612
AMC432241	AMC432408	MONSTER-613
AMC432241	AMC432409	MONSTER-614
AMC432241	AMC432410	MONSTER-615
AMC432241	AMC432411	MONSTER-616
AMC432241	AMC432412	MONSTER-617
AMC432241	AMC432413	MONSTER-618
AMC432241	AMC432414	MONSTER-619
AMC432241	AMC432415	MONSTER-620
AMC432241	AMC432416	MONSTER-621
AMC432241	AMC432417	MONSTER-622
AMC432443	AMC432443	MONSTER-564
AMC432443	AMC432444	MONSTER-565
AMC432443	AMC432445	MONSTER-566
AMC432443	AMC432446	MONSTER-567
AMC432443	AMC432447	MONSTER-568
AMC432443	AMC432448	MONSTER-569
AMC432443	AMC432449	MONSTER-570
AMC432443	AMC432450	MONSTER-571
AMC432443	AMC432451	MONSTER-572
AMC432443	AMC432452	MONSTER-573
AMC432443	AMC432453	MONSTER-574
AMC432443	AMC432454	MONSTER-575
AMC432443	AMC432455	MONSTER-576

AMC432443	AMC432456	MONSTER-577
AMC432443	AMC432457	MONSTER-578
AMC432443	AMC432458	MONSTER-579
AMC432443	AMC432459	MONSTER-580
AMC432443	AMC432460	MONSTER-581
AMC432443	AMC432461	MONSTER-582
AMC432443	AMC432462	MONSTER-583
AMC432443	AMC432463	MONSTER-584
AMC432443	AMC432464	MONSTER-585
AMC432443	AMC432465	MONSTER-586
AMC432443	AMC432466	MONSTER-587
AMC432443	AMC432467	MONSTER-588
AMC432486	AMC432489	RED BULL-496
AMC432486	AMC432492	RED BULL-499
AMC432486	AMC432493	RED BULL-500
AMC432486	AMC432494	RED BULL-501
AMC432486	AMC432495	RED BULL-502
AMC432486	AMC432496	RED BULL-503
AMC432486	AMC432497	RED BULL-504
AMC432486	AMC432498	RED BULL-505
AMC432486	AMC432499	RED BULL-506
AMC432486	AMC432500	RED BULL-507
AMC432486	AMC432501	RED BULL-508
AMC432486	AMC432503	RED BULL-510
AMC432486	AMC432504	RED BULL-511
AMC432486	AMC432505	RED BULL-512
AMC432486	AMC432508	RED BULL-515
AMC432486	AMC432509	RED BULL-516
AMC432486	AMC432513	RED BULL-520
AMC432486	AMC432517	RED BULL-524
AMC432486	AMC432521	RED BULL-528
AMC432486	AMC432522	RED BULL-529
AMC432486	AMC432531	RED BULL-592
AMC432486	AMC432532	RED BULL-593
AMC432486	AMC432533	RED BULL-594
AMC432486	AMC432534	RED BULL-595
AMC432486	AMC432535	RED BULL-596
AMC432486	AMC432536	RED BULL-597
AMC432486	AMC432537	RED BULL-598

AMC432486	AMC432538	RED BULL-599
AMC432486	AMC432539	RED BULL-600
AMC432486	AMC432540	RED BULL-601
AMC432486	AMC432541	RED BULL-602
AMC432486	AMC432542	RED BULL-603
AMC432486	AMC432543	RED BULL-604
AMC432486	AMC432555	RED BULL-616
AMC432486	AMC432556	RED BULL-617
AMC432486	AMC432557	RED BULL-618
AMC432486	AMC432558	RED BULL-619
AMC432486	AMC432559	RED BULL-620
AMC432486	AMC432560	RED BULL-621
AMC432486	AMC432567	RED BULL-628
AMC432486	AMC432568	RED BULL-629
AMC432486	AMC432571	RED BULL-632
AMC432486	AMC432572	RED BULL-633
AMC432486	AMC432580	RED BULL-641
AMC432486	AMC432581	RED BULL-642
AMC432486	AMC432582	RED BULL-643
AMC432486	AMC432583	RED BULL-644
AMC432486	AMC432584	RED BULL-645
AMC432486	AMC432585	RED BULL-646
AMC432486	AMC432586	RED BULL-647
AMC432486	AMC432587	RED BULL-648
AMC432486	AMC432588	RED BULL-649
AMC432486	AMC432589	RED BULL-650
AMC432486	AMC432590	RED BULL-651
AMC432486	AMC432591	RED BULL-652
AMC432486	AMC432592	RED BULL-653
AMC432486	AMC432593	RED BULL-654
AMC432486	AMC432594	RED BULL-655
AMC432486	AMC432595	RED BULL-656
AMC432486	AMC432596	RED BULL-657
AMC432486	AMC432597	RED BULL-658
AMC432486	AMC432598	RED BULL-659
AMC432486	AMC432599	RED BULL-660
AMC432486	AMC432600	RED BULL-661
AMC432486	AMC432601	RED BULL-662
AMC432486	AMC432602	RED BULL-663



AMC432486	AMC432603	RED BULL-664
AMC432486	AMC432604	RED BULL-665
AMC432486	AMC432605	RED BULL-666
AMC432486	AMC432606	RED BULL-667
AMC432486	AMC432607	RED BULL-668
AMC432486	AMC432608	RED BULL-669
AMC432486	AMC432609	RED BULL-670
AMC432486	AMC432610	RED BULL-671
AMC432486	AMC432611	RED BULL-672
AMC432486	AMC432612	RED BULL-673
AMC432486	AMC432613	RED BULL-674
AMC432486	AMC432614	RED BULL-675
AMC432486	AMC432615	RED BULL-676
AMC432486	AMC432616	RED BULL-677
AMC432486	AMC432617	RED BULL-678
AMC432486	AMC432618	RED BULL-679
AMC432486	AMC432619	RED BULL-680
AMC432621	AMC432621	ROCKSTAR 284
AMC432621	AMC432622	ROCKSTAR 285
AMC432621	AMC432623	ROCKSTAR 286
AMC432621	AMC432624	ROCKSTAR 287
AMC432621	AMC432625	ROCKSTAR 288
AMC432621	AMC432626	ROCKSTAR 289
AMC432621	AMC432627	ROCKSTAR 290
AMC432621	AMC432628	ROCKSTAR 291
AMC432621	AMC432629	ROCKSTAR 292
AMC432621	AMC432630	ROCKSTAR 293
AMC432621	AMC432631	ROCKSTAR 294
AMC432621	AMC432632	ROCKSTAR 295
AMC432621	AMC432633	ROCKSTAR 296
AMC432621	AMC432634	ROCKSTAR 297
AMC432621	AMC432635	ROCKSTAR 298
AMC432621	AMC432636	ROCKSTAR 299
AMC432621	AMC432637	ROCKSTAR 300
AMC432621	AMC432638	ROCKSTAR 301
AMC432621	AMC432639	ROCKSTAR 302
AMC432621	AMC432640	ROCKSTAR 303
AMC432621	AMC432641	ROCKSTAR 304
AMC432621	AMC432642	ROCKSTAR 305

AMC432621	AMC432643	ROCKSTAR 306
AMC432621	AMC432644	ROCKSTAR 307
AMC432621	AMC432645	ROCKSTAR 308
AMC432621	AMC432646	ROCKSTAR 309
AMC432621	AMC432647	ROCKSTAR 310
AMC432621	AMC432648	ROCKSTAR 311
AMC432621	AMC432649	ROCKSTAR 312
AMC432621	AMC432650	ROCKSTAR 313
AMC432621	AMC432651	ROCKSTAR 314
AMC432621	AMC432652	ROCKSTAR 315
AMC432621	AMC432653	ROCKSTAR 316
AMC432621	AMC432654	ROCKSTAR 317
AMC432621	AMC432655	ROCKSTAR 318
AMC432621	AMC432656	ROCKSTAR 319
AMC432621	AMC432657	ROCKSTAR 320
AMC432621	AMC432658	ROCKSTAR 321
AMC432621	AMC432659	ROCKSTAR 322
AMC432621	AMC432660	ROCKSTAR 323
AMC432621	AMC432661	ROCKSTAR 324
AMC432621	AMC432662	ROCKSTAR 325
AMC432621	AMC432663	ROCKSTAR 326
AMC432621	AMC432664	ROCKSTAR 327
AMC432621	AMC432665	ROCKSTAR 328
AMC432621	AMC432666	ROCKSTAR 329
AMC432621	AMC432667	ROCKSTAR 330
AMC432621	AMC432668	ROCKSTAR 331
AMC432621	AMC432669	ROCKSTAR 332
AMC432621	AMC432670	ROCKSTAR 333
AMC432621	AMC432671	ROCKSTAR 334
AMC432621	AMC432672	ROCKSTAR 335
AMC432621	AMC432673	ROCKSTAR 336
AMC432621	AMC432674	ROCKSTAR 337
AMC432621	AMC432675	ROCKSTAR 338
AMC432621	AMC432676	ROCKSTAR 339
AMC432621	AMC432677	ROCKSTAR 340
AMC432621	AMC432682	ROCKSTAR 345
AMC432621	AMC432683	ROCKSTAR 346
AMC432621	AMC432684	ROCKSTAR 347
AMC432621	AMC432685	ROCKSTAR 348

AMC432621	AMC432686	ROCKSTAR 349
AMC432621	AMC432770	ROCKSTAR 433
AMC432621	AMC432771	ROCKSTAR 434
AMC432621	AMC432772	ROCKSTAR 435
AMC432621	AMC432773	ROCKSTAR 436
AMC432621	AMC432774	ROCKSTAR 437
AMC432621	AMC432775	ROCKSTAR 438
AMC432621	AMC432776	ROCKSTAR 439
AMC432621	AMC432777	ROCKSTAR 440
AMC432621	AMC432778	ROCKSTAR 441
AMC432621	AMC432779	ROCKSTAR 442
AMC432621	AMC432780	ROCKSTAR 443
AMC432621	AMC432781	ROCKSTAR 444
AMC432621	AMC432782	ROCKSTAR 445
AMC432621	AMC432783	ROCKSTAR 446
AMC432621	AMC432784	ROCKSTAR 447
AMC432621	AMC432785	ROCKSTAR 448
AMC432621	AMC432786	ROCKSTAR 449
AMC432621	AMC432787	ROCKSTAR 450
AMC432621	AMC432788	ROCKSTAR 451
AMC432621	AMC432789	ROCKSTAR 452
AMC432621	AMC432790	ROCKSTAR 453
AMC432621	AMC432793	ROCKSTAR 456
AMC432621	AMC432794	ROCKSTAR 457
AMC432621	AMC432795	ROCKSTAR 458
AMC432621	AMC432796	ROCKSTAR 459
AMC432621	AMC432797	ROCKSTAR 460
AMC432621	AMC432798	ROCKSTAR 461
AMC432621	AMC432799	ROCKSTAR 462
AMC432621	AMC432800	ROCKSTAR 463
AMC432621	AMC432801	ROCKSTAR 464
AMC432621	AMC432802	ROCKSTAR 465
AMC432621	AMC432803	ROCKSTAR 466
AMC432621	AMC432807	ROCKSTAR 470
AMC432621	AMC432808	ROCKSTAR 471
AMC432621	AMC432876	ROCKSTAR 539
AMC432621	AMC432894	ROCKSTAR 557
AMC432621	AMC432895	ROCKSTAR 558
AMC432621	AMC432896	ROCKSTAR 559



AMC432621	AMC432897	ROCKSTAR 560
AMC432621	AMC432898	ROCKSTAR 561
AMC432994	AMC433084	ROCKSTAR 685
AMC432994	AMC433085	ROCKSTAR 686
AMC432994	AMC433086	ROCKSTAR 687
AMC432994	AMC433087	ROCKSTAR 688
AMC432994	AMC433092	ROCKSTAR 693
AMC432994	AMC433093	ROCKSTAR 694
AMC432994	AMC433094	ROCKSTAR 695
AMC432994	AMC433095	ROCKSTAR 696
AMC432994	AMC433096	ROCKSTAR 697
AMC432994	AMC433097	ROCKSTAR 698
AMC432994	AMC433098	ROCKSTAR 699
AMC432994	AMC433099	ROCKSTAR 700
AMC432994	AMC433104	ROCKSTAR 705
AMC432994	AMC433105	ROCKSTAR 706
AMC432994	AMC433106	ROCKSTAR 707
AMC432994	AMC433107	ROCKSTAR 708
AMC432994	AMC433332	ROCKSTAR 933
AMC432994	AMC433333	ROCKSTAR 934
AMC432994	AMC433334	ROCKSTAR 935
AMC432994	AMC433335	ROCKSTAR 936
AMC432994	AMC433336	ROCKSTAR 937
AMC432994	AMC433355	ROCKSTAR 956
AMC432994	AMC433356	ROCKSTAR 957
AMC432994	AMC433357	ROCKSTAR 958
AMC432994	AMC433358	ROCKSTAR 959
AMC432994	AMC433359	ROCKSTAR 960
AMC432994	AMC433360	ROCKSTAR 961
AMC432994	AMC433361	ROCKSTAR 962
AMC432994	AMC433362	ROCKSTAR 963
AMC432994	AMC433363	ROCKSTAR 964
AMC432994	AMC433364	ROCKSTAR 965
AMC432994	AMC433365	ROCKSTAR 966
AMC432994	AMC433366	ROCKSTAR 967
AMC432994	AMC433367	ROCKSTAR 968
AMC432994	AMC433368	ROCKSTAR 969
AMC432994	AMC433369	ROCKSTAR 970
AMC432994	AMC433370	ROCKSTAR 971

AMC432994	AMC433371	ROCKSTAR 973
AMC432994	AMC433372	ROCKSTAR 974
AMC432994	AMC433373	ROCKSTAR 975
AMC432994	AMC433374	ROCKSTAR 976
AMC432994	AMC433375	ROCKSTAR 977
AMC432994	AMC433376	ROCKSTAR 978
AMC432994	AMC433377	ROCKSTAR 979
AMC432994	AMC433378	ROCKSTAR 980
AMC432994	AMC433387	ROCKSTAR 989
AMC432994	AMC433388	ROCKSTAR 990
AMC432994	AMC433389	ROCKSTAR 991
AMC432994	AMC433390	ROCKSTAR 992
AMC432994	AMC433399	ROCKSTAR 1001
AMC432994	AMC433400	ROCKSTAR 1002
AMC432994	AMC433401	ROCKSTAR 1003
AMC432994	AMC433402	ROCKSTAR 1004
AMC432994	AMC433403	ROCKSTAR 1005
AMC432994	AMC433404	ROCKSTAR 1006
AMC432994	AMC433405	ROCKSTAR 1007





Date Produced: 11/02/2020

ConnectSuite Inc.:

The following is the delivery information for Certified Mail™/RRE item number 9214 8901 9403 8323 3302 75. Our records indicate that this item was delivered on 10/26/2020 at 11:04 a.m. in SAFFORD, AZ 85546. The scanned image of the recipient information is provided below.

Signature of Recipient :

P. Cray

Address of Recipient :

1019

Thank you for selecting the Postal Service for your mailing needs. If you require additional assistance, please contact your local post office or Postal Service representative.

Sincerely,  
United States Postal Service

The customer reference number shown below is not validated or endorsed by the United States Postal Service. It is solely for customer use.

Customer Reference Number: C2329039.13257674

AMC 359924  
364985  
431541  
432120  
432933

Southwest Exploration Group LLC  
580 S. Prospectors Road  
Apache Junction, AZ 85119

August 28, 2018

Arizona State Office  
Bureau of Land Management  
One N Central Ave. Suite 800  
Phoenix AZ 85004-4427

RECEIVED  
BLM AZ STATE OFFICE  
2018 AUG 31 A 11: 21  
PHOENIX, ARIZONA

Dear Arizona State Office Personnel,

Enclosed is a check for \$17,980.00 for maintenance fees for 116 unpatented mining claims listed on Exhibit A.

Best regards,

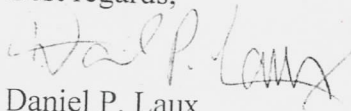

Daniel P. Laux  
Member  
Southwest Exploration Group LLC

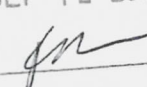
ENTERED  
SEP 12 2018  
BY: 

#4256103

# Exhibit A - Graham County Claim Listing

Southwest Exploration Group LLC

08/18/18

	Name	AMC#	Graham Co. Info	TWP	RNG	SEC
1	CS-1	AMC359924	2004-00903	5S	26E	20
2	CS-2	AMC359925	2004-00904	5S	26E	20
3	CS-3	AMC359926	2004-00905	5S	26E	20
4	CS-4	AMC359927	2004-00906	5S	26E	20
5	CS-5	AMC359928	2004-00907	5S	26E	20
6	CS-6	AMC359929	2004-00908	5S	26E	20
7	CS-7	AMC359930	2004-00909	5S	26E	20
8	CS-8	AMC359931	2004-00910	5S	26E	20
9	CS-9	AMC359932	2004-00911	5S	26E	17
10	CS-10	AMC359933	2004-00912	5S	26E	17
11	CS-11	AMC359934	2004-00913	5S	26E	17
12	CS-12	AMC359935	2004-00914	5S	26E	17
13	CS-13	AMC359936	2004-00915	5S	26E	17
14	CS-14	AMC359937	2004-00916	5S	26E	17
15	CS-27	AMC359950	2004-00929	5S	26E	19/20
16	CS-28	AMC359951	2004-00930	5S	26E	20
17	CS-29	AMC359952	2004-00931	5S	26E	20
18	CS-30	AMC359953	2004-00932	5S	26E	20
19	CS-31	AMC359954	2004-00933	5S	26E	20
20	CS-32	AMC359955	2004-00934	5S	26E	20
21	CS-33	AMC359956	2004-00935	5S	26E	19/20
22	CS-34	AMC359957	2004-00936	5S	26E	20
23	CS-35	AMC359958	2004-00937	5S	26E	17/18
24	CS-36	AMC359959	2004-00938	5S	26E	17
25	CS-37	AMC359960	2004-00939	5S	26E	17/18
26	CS-38	AMC359961	2004-00940	5S	26E	17
27	CS-39	AMC359962	2004-00941	5S	26E	17/18
28	CS-40	AMC359963	2004-00942	5S	26E	17
29	CS-41	AMC432933	2015-04201	5S	26E	17/18
30	CS-42	AMC432934	2015-04202	5S	26E	17
31	CS-43	AMC432935	2015-04203	5S	26E	17/18
32	CS-44	AMC432936	2015-04204	5S	26E	17
33	CS-45	AMC432937	2015-04205	5S	26E	17/18
34	CS-46	AMC432938	2015-04206	5S	26E	17
35	CS-47	AMC432939	2015-04207	5S	26E	17/18
36	CS-48	AMC432940	2015-04208	5S	26E	17
37	CS-49	AMC432941	2015-04209	5S	26E	17/18
38	CS-50	AMC432942	2015-04210	5S	26E	17
39	CS-51	AMC432943	2015-04211	5S	26E	17/18
40	CS-52	AMC432944	2015-04212	5S	26E	17
41	CS-53	AMC359976	2004-00955	5S	26E	21

RECEIVED  
 BLM AZ STATE OFFICE  
 PHOENIX, ARIZONA  
 8/31/18

# Exhibit A - Graham County Claim Listing

Southwest Exploration Group LLC

08/18/18

	Name	AMC#	Graham Co. Info	TWP	RNG	SEC
42	CS-54	AMC359977	2004-00956	5S	26E	21
43	CS-55	AMC359978	2004-00957	5S	26E	21
44	CS-56	AMC364985	2005-02173	5S	26E	19
45	CS-57	AMC364986	2005-02174	5S	26E	19
46	CS-58	AMC364987	2005-02175	5S	26E	19
47	CS-59	AMC364988	2005-02176	5S	26E	19
48	CS-60	AMC364989	2005-02177	5S	26E	19
49	CS-61	AMC364990	2005-02178	5S	26E	19
50	CS-62	AMC364991	2005-02179	5S	26E	19
51	CS-63	AMC364992	2005-02180	5S	26E	19
52	CS-64	AMC364993	2005-02181	5S	26E	19
53	CS-65	AMC364994	2005-02182	5S	26E	18
54	CS-66	AMC364995	2005-02183	5S	26E	18
55	CS-67	AMC364996	2005-02184	5S	26E	18
56	CS-68	AMC364997	2005-02185	5S	26E	18
57	CS-69	AMC364998	2005-02186	5S	26E	18
58	CS-82	AMC365011	2005-02199	5S	26E	19
59	CS-83	AMC365012	2005-02200	5S	26E	19
60	CS-84	AMC365013	2005-02201	5S	26E	19
61	CS-85	AMC365014	2005-02202	5S	26E	19
62	CS-86	AMC365015	2005-02203	5S	26E	18
63	CS-87	AMC365016	2005-02204	5S	26E	18
64	CS-88	AMC365017	2005-02205	5S	26E	18
65	RED BULL - 397	AMC431506	2015-2148	T5S	R25-26E	13/24;18/19
66	RED BULL - 398	AMC431507	2015-2149	T5S	R25-26E	13;18
67	RED BULL - 399	AMC431508	2015-2150	T5S	R25-26E	13;18
68	RED BULL - 400	AMC431509	2015-2151	T5S	R25-26E	13;18
69	RED BULL - 401	AMC431510	2015-2152	T5S	R25-26E	13;18
70	RED BULL - 402	AMC431511	2015-2153	T5S	R25-26E	13;18
71	RED BULL - 403	AMC431512	2015-2154	T5S	R25-26E	13;18
72	RED BULL - 404	AMC431513	2015-2155	T5S	R25-26E	13;18
73	RED BULL - 405	AMC431514	2015-2156	T5S	R25-26E	13;18
74	RED BULL - 406	AMC431515	2015-2157	T5S	R25E	13/24
75	RED BULL - 407	AMC431516	2015-2158	T5S	R25E	13
76	RED BULL - 408	AMC431517	2015-2159	T5S	R25E	13
77	RED BULL - 409	AMC431518	2015-2160	T5S	R25E	13
78	RED BULL - 410	AMC431519	2015-2161	T5S	R25E	13
79	RED BULL - 411	AMC431520	2015-2162	T5S	R25E	13
80	RED BULL - 412	AMC431521	2015-2163	T5S	R25E	13
81	RED BULL - 413	AMC431522	2015-2164	T5S	R25E	13
82	RED BULL - 414	AMC431523	2015-2165	T5S	R25E	13

RECEIVED  
 BIRMINGHAM STATE OFFICE  
 2018 AUG 31 A 11:31  
 BHOENIX, ARIZONA

# Exhibit A - Graham County Claim Listing

Southwest Exploration Group LLC

08/18/18

	Name	AMC#	Graham Co. Info	TWP	RNG	SEC
83	RED BULL - 415	AMC431524	2015-2166	T5S	R25E	13/24
84	RED BULL - 416	AMC431525	2015-2167	T5S	R25E	13
85	RED BULL - 417	AMC431526	2015-2168	T5S	R25E	13
86	RED BULL - 418	AMC431527	2015-2169	T5S	R25E	13
87	RED BULL - 419	AMC431528	2015-2170	T5S	R25E	13
88	RED BULL - 420	AMC431529	2015-2171	T5S	R25E	13
89	RED BULL - 421	AMC431530	2015-2172	T5S	R25E	13
90	RED BULL - 422	AMC431531	2015-2173	T5S	R25E	13
91	RED BULL - 423	AMC431532	2015-2174	T5S	R25E	13
92	RED BULL - 424	AMC431533	2015-2175	T5S	R25E	13/14/23/24
93	RED BULL - 425	AMC431534	2015-2176	T5S	R25E	13/14
94	RED BULL - 426	AMC431535	2015-2177	T5S	R25E	13/14
95	RED BULL - 427	AMC431536	2015-2178	T5S	R25E	13/14
96	RED BULL - 428	AMC431537	2015-2179	T5S	R25E	13/14
97	RED BULL - 429	AMC431538	2015-2180	T5S	R25E	13/14
98	RED BULL - 430	AMC431539	2015-2181	T5S	R25E	13/14
99	RED BULL - 431	AMC431540	2015-2182	T5S	R25E	13/14
100	RED BULL - 432	AMC431541	2015-2183	T5S	R25E	13/14
101	RED BULL - 438	AMC432143	2015-3044	T5S	R25E	24
102	RED BULL - 439	AMC432144	2015-3045	T5S	R25E	24
103	RED BULL - 440	AMC432145	2015-3046	T5S	R25E	24
104	RED BULL - 441	AMC432146	2015-3047	T5S	R25E	24
105	RED BULL - 447	AMC432152	2015-3053	T5S	R25E	24
106	RED BULL - 448	AMC432153	2015-3054	T5S	R25E	24
107	RED BULL - 449	AMC432154	2015-3055	T5S	R25E	24
108	RED BULL - 450	AMC432155	2015-3056	T5S	R25E	24
109	RED BULL - 456	AMC432161	2015-3062	T5S	R25E	24
110	RED BULL - 457	AMC432162	2015-3063	T5S	R25E	24
111	RED BULL - 458	AMC432163	2015-3064	T5S	R25E	24
112	RED BULL - 459	AMC432164	2015-3065	T5S	R25E	24
113	RED BULL - 465	AMC432170	2015-3071	T5S	R25E	23/24
114	RED BULL - 466	AMC432171	2015-3072	T5S	R25E	23/24
115	RED BULL - 467	AMC432172	2015-3073	T5S	R25E	23/24
116	RED BULL - 468	AMC432173	2015-3074	T5S	R25E	23/24

RECEIVED  
 2018 AUG 31 A 11:21  
 SHERIFF'S OFFICE



Southwest Exploration Group  
580 S Prospectors Rd  
Apache Junction AZ 85119

**CERTIFIED MAIL**



7017 1450 0001 3081 5830



85004

U.S. POSTAGE PAID  
FCM LETTER  
TIGLEY, AZ  
85236  
AUG 28, 18  
AMOUNT

**\$6.70**

R2305K142627-01

Arizona State Office  
Bureau of Land Management  
One W Central Ave, Suite 800  
Phoenix AZ 85004-4427

PHOENIX, ARIZONA

2018 AUG 31 A 11:31

PHOENIX STATE OFFICE

**United States Department of the Interior**  
**Bureau of Land Management**  
 DIV OF LANDS, MINRLS & ENERGY  
 ONE N CENTRAL AVE  
 PHOENIX, AZ 85004 -4427  
 Phone: 602-417-9200

Receipt

No: 4256103

<b>Transaction #:</b> 4371648	
<b>Date of Transaction:</b> 09/05/2018	
<b>CUSTOMER:</b>	
SOUTHWEST EXPLORATION GROUP LLC 580 S PROSPECTORS RD APACHE JUNCTION, AZ 85119-8828 US	

LINE #	QTY	DESCRIPTION	REMARKS	UNIT PRICE	TOTAL
1	1.00	LOCATABLE MINERALS / MINING CLAIMS- NOT NEW-UNADJUD, ONE AUTH NO. ONLY / MINING CLAIM MONEY RECEIVED <b>CASES: AMC359924/\$17980.00</b>	MAINT 2019/116	- n/a -	17980.00
<b>TOTAL:</b>					<b>\$17,980.00</b>

PAYMENT INFORMATION			
1	AMOUNT:	17980.00	POSTMARKED: N/A
	TYPE:	CHECK	RECEIVED: 08/31/2018
	CHECK NO:	1170	
	NAME:	SOUTHWEST EXPLORATION GROUP LLC 7834 E CANNON DR SCOTTSDALE AZ 85258 US	

REMARKS

This receipt was generated by the automated BLM Collections and Billing System and is a paper representation of a portion of the official electronic record contained therein.

AMC46122

47901

66892

78466

101235

113312

288506

289500

292727

293492

294150

294346

298849

298861

298929

305755

321860

324229

324366

324842

326065

326786

329064

329094

330967

331727

333390

334772

340495

340956

341652

344109

430691

430751

430889

431071

431121

431317

431566

431611

431791

431904

432120

432241

432443

432486

432621

432994

433439



June 21, 2018

After recording, return to:  
Freeport-McMoRan  
Attn: C. Loder  
333 North Central Avenue  
Phoenix, AZ 85004

Bureau of Land Management  
Department of the Interior  
One N. Central Avenue  
Phoenix, AZ 85004

2018

**NOTICE OF INTENT TO HOLD MINING CLAIMS AND PAYMENT OF BLM  
MAINTENANCE FEE**

Re: Payment of Annual Claim Maintenance Fee

Dear Sir or Madam:

This will serve as notice that Freeport-McMoRan Safford, Inc., whose address for purposes of this filing is Land and Water Department, 333 North Central Ave., Phoenix, Arizona 85004, intends to hold the mining claims and/or mill sites described on Exhibit A attached hereto for the assessment year ending at 12 o'clock, noon, on September 1, 2019 by payment of the annual maintenance fee of \$155 per claim or site. Payment of such amount is made herewith for such assessment year for each of the claims and sites, the name, and BLM serial number with the book and page or index number of recording of the location notice in the official records of Graham County, Arizona, of which, is set forth on Exhibit A attached hereto and by this reference incorporated herein.

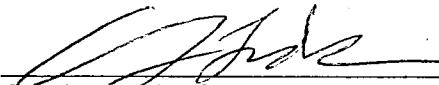
  
\_\_\_\_\_  
Carolyn Loder for  
Freeport-McMoRan Safford, Inc.

RECEIVED  
BLM STATE OFFICE  
JUN 25 P 12:59  
PHOENIX, ARIZONA

State of Arizona )  
  ) ss.  
County of Maricopa )

The foregoing instrument was acknowledged before me on June 21<sup>st</sup>, 2018, by Carolyn Loder, on behalf of Freeport-McMoRan Safford, Inc.

(Seal)

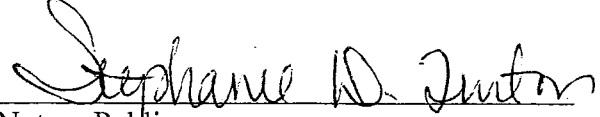

  
\_\_\_\_\_  
Notary Public  
My commission expires: 11-18-2019

JUN 27 2018

RAN

~~AMC 46122~~

### EXHIBIT A

County: Graham

State: AZ

BLM Serial #	Claim Name	Original Recording		Amended Recording		Location
		Recording #	Page #	Recording #	Page #	
AMC 046122	GEM 1	210	420			SEC26-T06S-R27E
AMC 046123	GEM 2	210	421			SEC35-T06S-R27E
AMC 046124	GEM 3	210	422			SEC35-T06S-R27E
AMC 046125	GEM 4	210	423			SEC35-T06S-R27E
AMC 046126	GEM 5	210	424			SEC35-T06S-R27E
AMC 046127	GEM 6	210	425	531	520	SEC35-T06S-R27E
AMC 046131	GEM 10	210	429			SEC26-T06S-R27E
AMC 046132	GEM 11	210	430			SEC26-T06S-R27E
AMC 046133	GEM 12	210	431			SEC35-T06S-R27E
AMC 046134	GEM 13	210	432			SEC35-T06S-R27E
AMC 046135	GEM 14	210	433			SEC35-T06S-R27E
AMC 046136	GEM 15	210	434			SEC35-T06S-R27E
AMC 046137	GEM 16	210	435			SEC35-T06S-R27E
AMC 046138	GEM 17	210	436			SEC35-T06S-R27E
AMC 046139	GEM 18	210	437			SEC35-T06S-R27E
AMC 046140	GEM 19	210	438			SEC35-T06S-R27E
AMC 046141	GEM 20	210	439			SEC26-T06S-R27E
AMC 046142	GEM 21	210	440			SEC26-T06S-R27E
AMC 046143	GEM 22	210	441			SEC26-T06S-R27E
AMC 046144	GEM 23	210	442			SEC26-T06S-R27E
AMC 046145	GEM 24	210	443			SEC26-T06S-R27E
AMC 046146	GEM 25	210	444			SEC26-T06S-R27E
AMC 046147	GEM 26	210	445			SEC26-T06S-R27E
AMC 046148	GEM 27	210	446			SEC26-T06S-R27E
AMC 046149	GEM 28	210	447			SEC26-T06S-R27E
AMC 046150	GEM 29	210	448			SEC26-T06S-R27E
AMC 046151	GEM 30	210	449			SEC26-T06S-R27E
AMC 046152	GEM 31	210	450			SEC26-T06S-R27E
AMC 046153	GEM 32	210	451			SEC26-T06S-R27E
AMC 046154	GEM 33	210	452			SEC26-T06S-R27E
AMC 046171	GEM 50	210	469			SEC26-T06S-R27E
AMC 046172	GEM 51	210	470			SEC26-T06S-R27E
AMC 046173	GEM 52	210	471			SEC26-T06S-R27E
AMC 046174	GEM 53	210	472			SEC26-T06S-R27E
AMC 046175	GEM 54	210	473			SEC26-T06S-R27E
AMC 046176	GEM 55	210	474			SEC26-T06S-R27E
AMC 046177	GEM 56	210	475			SEC26-T06S-R27E
AMC 046203	GEM 82	210	501			SEC26-T06S-R27E

Date: 5/23/2018

Page 1

RECEIVED  
BLM AZ STATE OFFICE  
PHOENIX, ARIZONA  
2018 JUN 25 P 12:59

## EXHIBIT A

County: Graham

State: AZ

BLM Serial #	Claim Name	Original Recording		Amended Recording		Location
		Recording #	Page #	Recording #	Page #	
AMC 046204 7	GEM 83	210	502			SEC26-T06S-R27E
AMC 046205	GEM 84	210	503			SEC26-T06S-R27E
AMC 046206	GEM 85	210	504			SEC26-T06S-R27E
AMC 046207	GEM 86	210	505			SEC26-T06S-R27E
AMC 046208	GEM 87	210	506			SEC26-T06S-R27E
AMC 046209	GEM 88	210	507			SEC26-T06S-R27E
AMC 046210	GEM 89	210	508			SEC26-T06S-R27E
AMC 046211	GEM 90	210	509			SEC26-T06S-R27E
AMC 046212	GEM 91	210	510			SEC26-T06S-R27E
AMC 046213	GEM 92	210	511			SEC26-T06S-R27E
AMC 046214	GEM 93	210	512			SEC26-T06S-R27E
AMC 046215	GEM 94	210	513			SEC26-T06S-R27E
AMC 046216	GEM 95	210	514			SEC26-T06S-R27E
AMC 046217	GEM 96	210	515			SEC26-T06S-R27E
AMC 046218	GEM 97	210	516			SEC26-T06S-R27E
AMC 046219	GEM 98	210	517			SEC26-T06S-R27E
AMC 046220	GEM 99	210	518			SEC26-T06S-R27E
AMC 046221	GEM 100	210	519			SEC26-T06S-R27E
AMC 046222	GEM 101	210	520			SEC26-T06S-R27E
AMC 046223	GEM 102	210	521			SEC26-T06S-R27E
AMC 046224	GEM 103	210	522			SEC26-T06S-R27E
AMC 046225	GEM 104	210	523			SEC26-T06S-R27E
AMC 046226	GEM 105	210	524			SEC26-T06S-R27E
AMC 046227	GEM 106	210	525			SEC26-T06S-R27E
AMC 046228	GEM 107	210	526			SEC26-T06S-R27E
AMC 046229	GEM 108	210	527			SEC26-T06S-R27E
AMC 046230	GEM 109	210	528			SEC26-T06S-R27E
AMC 046231	GEM 110	210	529			SEC26-T06S-R27E
AMC 046232	GEM 111	210	530			SEC26-T06S-R27E
AMC 046233	GEM 112	210	531			SEC26-T06S-R27E
AMC 046234	GEM 113	210	532			SEC23-T06S-R27E
AMC 046235	GEM 114	210	533			SEC23-T06S-R27E
AMC 046236	GEM 115	210	534			SEC23-T06S-R27E
AMC 046237	GEM 116	210	535			SEC23-T06S-R27E
AMC 046238	GEM 117	210	536			SEC25-T06S-R27E
AMC 046239	GEM 118	210	537			SEC25-T06S-R27E
AMC 046240	GEM 119	210	538			SEC25-T06S-R27E
AMC 046241 ✓	GEM 120	210	539			SEC25-T06S-R27E

Date: 5/23/2018

RECEIVED  
 BLM AZ STATE OFFICE  
 2018 JUN 25 P 12:59  
 PHOENIX, ARIZONA

## EXHIBIT A

County: Graham

State: AZ

<u>BLM Serial #</u>	<u>Claim Name</u>	<u>Original Recording</u>		<u>Amended Recording</u>		<u>Location</u>
		<u>Recording #</u>	<u>Page #</u>	<u>Recording #</u>	<u>Page #</u>	
AMC 046242	GEM 121	210	540			SEC25-T06S-R27E
AMC 046243	GEM 122	210	541			SEC25-T06S-R27E
AMC 046244	GEM 123	210	542			SEC25-T06S-R27E
AMC 046245	GEM 124	210	543			SEC25-T06S-R27E
AMC 046246	GEM 125	210	544			SEC25-T06S-R27E
AMC 046247	GEM 126	210	545			SEC25-T06S-R27E
AMC 046248	GEM 127	210	546			SEC25-T06S-R27E
AMC 046249	GEM 128	210	547			SEC25-T06S-R27E
AMC 046250	GEM 129	210	548			SEC25-T06S-R27E
AMC 046251	GEM 130	210	549			SEC25-T06S-R27E
AMC 046252	GEM 131	210	550			SEC25-T06S-R27E
AMC 046253	GEM 132	210	551			SEC25-T06S-R27E
AMC 046254	GEM 133	210	552			SEC25-T06S-R27E
AMC 046255	GEM 134	210	553			SEC25-T06S-R27E
AMC 046256	GEM 135	210	554			SEC25-T06S-R27E
AMC 046257	GEM 136	210	555			SEC25-T06S-R27E
AMC 046258	GEM 137	210	556			SEC25-T06S-R27E
AMC 046259	GEM 138	210	557			SEC25-T06S-R27E
AMC 046260	GEM 139	210	558			SEC25-T06S-R27E
AMC 046261	GEM 140	210	559			SEC25-T06S-R27E
AMC 046262	GEM 141	210	560			SEC25-T06S-R27E
AMC 046263	GEM 142	210	561			SEC25-T06S-R27E
AMC 046264	GEM 143	210	562			SEC25-T06S-R27E
AMC 046265	GEM 144	210	563			SEC25-T06S-R27E
AMC 046266	GEM 145	210	564			SEC25-T06S-R27E
AMC 046267	GEM 146	210	565			SEC25-T06S-R27E
AMC 046268	GEM 147	210	566			SEC25-T06S-R27E
AMC 046269	GEM 148	210	567			SEC25-T06S-R27E
AMC 046270	GEM 149	210	568			SEC25-T06S-R27E
AMC 046271	GEM 150	210	569			SEC25-T06S-R27E
AMC 046272	GEM 151	210	570			SEC25-T06S-R27E
AMC 046273	GEM 152	210	571			SEC25-T06S-R27E
AMC 046274	GEM 153	210	572			SEC25-T06S-R27E
AMC 046275	GEM 154	210	573			SEC25-T06S-R27E
AMC 046276	GEM 155	210	574			SEC25-T06S-R27E
AMC 046277	GEM 156	210	575			SEC25-T06S-R27E
AMC 046278	GEM 157	210	576			SEC25-T06S-R27E
AMC 046279	GEM 158	210	577			SEC25-T06S-R27E

Date: 5/23/2018

RECEIVED  
BLM AZ STATE OFFICE  
2018 JUN 25 P 12:59  
PHOENIX, ARIZONA

## EXHIBIT A

County: Graham

State: AZ

<u>BLM Serial #</u>	<u>Claim Name</u>	<u>Original Recording</u>		<u>Amended Recording</u>		<u>Location</u>
		<u>Recording #</u>	<u>Page #</u>	<u>Recording #</u>	<u>Page #</u>	
AMC 046280	GEM 159	210	578			SEC25-T06S-R27E
AMC 046281	GEM 160	210	579			SEC25-T06S-R27E
AMC 046282	GEM 161	210	580			SEC25-T06S-R27E
AMC 046283	GEM 162	210	581			SEC25-T06S-R27E
AMC 046284	GEM 163	210	582			SEC25-T06S-R27E
AMC 046285	GEM 164	210	583			SEC25-T06S-R27E
AMC 046286	GEM 165	210	584			SEC25-T06S-R27E
AMC 046287	GEM 166	210	585			SEC25-T06S-R27E
AMC 046288	GEM 167	210	586			SEC25-T06S-R27E
AMC 046289	GEM 168	210	587			SEC25-T06S-R27E
AMC 046290	GEM 169	210	588			SEC25-T06S-R27E
AMC 046291	GEM 170	210	589			SEC25-T06S-R27E
AMC 046292	GEM 171	210	590			SEC25-T06S-R27E
AMC 046293	GEM 172	210	591			SEC25-T06S-R27E
AMC 046294	GEM 173	210	592			SEC25-T06S-R27E
AMC 046295	GEM 174	210	593			SEC30-T06S-R28E
AMC 046296	GEM 175	210	594			SEC30-T06S-R28E
AMC 046297	GEM 176	210	595			SEC25-T06S-R27E
AMC 046298	GEM 177	210	596			SEC25-T06S-R27E
AMC 046299	GEM 178	210	597			SEC25-T06S-R27E
AMC 046300	GEM 179	210	598			SEC25-T06S-R27E
AMC 046301	GEM 180	210	599			SEC25-T06S-R27E
AMC 046302	GEM 181	210	600			SEC25-T06S-R27E
AMC 046303	GEM 182	211	1			SEC25-T06S-R27E
AMC 046304	GEM 183	211	2			SEC25-T06S-R27E
AMC 046305	GEM 184	211	3			SEC25-T06S-R27E
AMC 046306	GEM 185	211	4			SEC25-T06S-R27E
AMC 046307	GEM 186	211	5			SEC25-T06S-R27E
AMC 046308	GEM 187	211	6			SEC25-T06S-R27E
AMC 046309	GEM 188	211	7			SEC25-T06S-R27E
AMC 046310	GEM 189	211	8			SEC25-T06S-R27E
AMC 046311	GEM 190	211	9			SEC25-T06S-R27E
AMC 046312	GEM 191	211	10			SEC25-T06S-R27E
AMC 046313	GEM 192	211	11			SEC25-T06S-R27E
AMC 046314	GEM 193	211	12			SEC25-T06S-R27E
AMC 046315	GEM 194	211	13			SEC25-T06S-R27E
AMC 046316	GEM 195	211	14			SEC25-T06S-R27E
AMC 046317	GEM 196	211	15			SEC25-T06S-R27E

Date: 5/23/2018

RECEIVED  
BLM AZ STATE OFFICE  
PHOENIX, ARIZONA  
JUN 25 12:54 PM 2018

## EXHIBIT A

County: Graham

State: AZ

BLM Serial #	Claim Name	Original Recording		Amended Recording		Location
		Recording #	Page #	Recording #	Page #	
AMC 046318	GEM 197	211	16			SEC25-T06S-R27E
AMC 046319	GEM 198	211	17			SEC25-T06S-R27E
AMC 046320	GEM 199	211	18			SEC25-T06S-R27E
AMC 046321	GEM 200	211	19			SEC25-T06S-R27E
AMC 046322	GEM 201	211	20			SEC25-T06S-R27E
AMC 046323	GEM 202	211	21			SEC30-T06S-R28E
AMC 046324	GEM 203	211	22			SEC30-T06S-R28E
AMC 046328	GEM 207	211	26			SEC30-T06S-R28E
AMC 046329	GEM 208	211	27			SEC25-T06S-R27E
AMC 046330	GEM 209	211	28			SEC25-T06S-R27E
AMC 046331	GEM 210	211	29			SEC25-T06S-R27E
AMC 046332	GEM 211	211	30			SEC25-T06S-R27E
AMC 046333	GEM 212	211	31			SEC25-T06S-R27E
AMC 046334	GEM 213	211	32			SEC25-T06S-R27E
AMC 046335	GEM 214	211	33			SEC25-T06S-R27E
AMC 046336	GEM 215	211	34			SEC25-T06S-R27E
AMC 046337	GEM 216	211	35			SEC25-T06S-R27E
AMC 046338	GEM 217	211	36			SEC25-T06S-R27E
AMC 046339	GEM 218	211	37			SEC25-T06S-R27E
AMC 046340	GEM 219	211	38			SEC24-T06S-R27E
AMC 046341	GEM 220	211	39			SEC24-T06S-R27E
AMC 046342	GEM 221	211	40			SEC24-T06S-R27E
AMC 046343	GEM 222	211	41			SEC24-T06S-R27E
AMC 046344	GEM 223	211	42			SEC24-T06S-R27E
AMC 046345	GEM 224	211	43			SEC19-T06S-R28E
AMC 046352	GEM 231	211	50			SEC19-T06S-R28E
AMC 046353	GEM 232	211	51			SEC24-T06S-R27E
AMC 046354	GEM 233	211	52			SEC24-T06S-R27E
AMC 046355	GEM 234	211	53			SEC24-T06S-R27E
AMC 046356	GEM 235	211	54			SEC24-T06S-R27E
AMC 046380	Basalt No. 7	92	624	519	13	SEC26-T06S-R27E
AMC 046381	Basalt No. 8	92	625	519	15	SEC26-T06S-R27E
AMC 046382	Basalt No. 9	92	626	519	17	SEC26-T06S-R27E
AMC 046383	Basalt No. 10	92	656	519	19	SEC35-T06S-R27E
AMC 046388	Basalt No. 17	92	689	519	21	SEC25-T06S-R27E
AMC 046391	Basalt No. 23	98	139			SEC25-T06S-R27E
AMC 046392	Basalt No. 24	98	140	519	23	SEC25-T06S-R27E
AMC 046393	Basalt No. 25	98	141	519	25	SEC25-T06S-R27E

Date: 5/23/2018

RECEIVED  
BLM AZ STATE OFFICE  
JUN 25 12:58 PM 2018  
PHOENIX, ARIZONA

## EXHIBIT A

County: Graham

State: AZ

BLM Serial #	Claim Name	Original Recording		Amended Recording		Location
		Recording #	Page #	Recording #	Page #	
AMC 046468 7	Jerico	82	548	531	522	SEC35-T06S-R27E
AMC 046469 J	Jerico No. 2	82	549	519	45	SEC35-T06S-R27E
AMC 047907 7	Shasta No. 1	39	396			SEC26-T06S-R27E
AMC 047908	Shasta No. 2	39	397			SEC26-T06S-R27E
AMC 047909	Shasta No. 3	39	398	519	57	SEC26-T06S-R27E
AMC 047910 J	Shasta No. 4	39	399	519	59	SEC26-T06S-R27E
AMC 047913 7	Fox No. 3	36	506	519	27	SEC26-T06S-R27E
AMC 047914	Fox No. 4	36	507	519	29	SEC26-T06S-R27E
AMC 047915	Fox No. 5	36	508	519	31	SEC26-T06S-R27E
AMC 047916	Fox No. 6	36	509	519	33	SEC25-T06S-R27E
AMC 047917 J	Fox No. 7	36	510	519	35	SEC25-T06S-R27E
AMC 047920 7	Fox No. 18	75	625	519	37	SEC26-T06S-R27E
AMC 047921	Fox No. 19	75	626	519	39	SEC26-T06S-R27E
AMC 047922	Fox No. 20	75	627	519	41	SEC26-T06S-R27E
AMC 047923	Pat No. 3	39	404	519	47	SEC26-T06S-R27E
AMC 047924 J	Pat No. 4	39	405			SEC26-T06S-R27E
AMC 047926 7	Pat No. 6	89	674	519	49	SEC25-T06S-R27E
AMC 047927	Pat No. 7	89	675	519	51	SEC25-T06S-R27E
AMC 047928	Pat No. 8	89	676	519	53	SEC25-T06S-R27E
AMC 047929	Pat No. 9	89	677	519	55	SEC25-T06S-R27E
AMC 047930	AI No. 1	39	384	519	9	SEC26-T06S-R27E
AMC 047931 J	AI No. 2	39	385	519	11	SEC26-T06S-R27E
AMC 067551 -	Senorbac 24A	44	433	415	301	SEC31-T05S-R27E
AMC 067557 7	Senorbac 30A	44	439	415	317	SEC31-T05S-R27E
AMC 067558 J	Senorbac 31A	44	440	415	329	SEC31-T05S-R27E
AMC 067561 -	Senorbac 35A	44	443	415	333	SEC31-T05S-R27E
AMC 067596 -	A-1A	41	242	410	469	SEC12-T06S-R26E
AMC 067615 7	Bush 32A	53	386	414	21	SEC14-T06S-R26E
AMC 067616	Bush 33A	53	387	414	23	SEC14-T06S-R26E
AMC 067617	Bush 34A	53	388	414	25	SEC14-T06S-R26E
AMC 067618	Bush 35A	53	389	414	27	SEC14-T06S-R26E
AMC 067619 J	Bush 36A	53	390	414	29	SEC14-T06S-R26E
AMC 067633 7	Con. Metals No. 20A	31	597	410	451	SEC12-T06S-R26E
AMC 067634 J	Coors A	41	241	410	471	SEC12-T06S-R26E
AMC 067637 -	Griesdieck A	41	5	410	473	SEC12-T06S-R26E
AMC 067642 -	Ithaca No. 20A	41	235	410	461	SEC12-T06S-R26E
AMC 067655 7	Pabst A	41	240	414	37	SEC14-T06S-R26E
AMC 067656 J	Schlitz A	41	246	414	35	SEC14-T06S-R26E

Date: 5/23/2018

RECEIVED  
BLM AZ STATE OFFICE  
PHOENIX, ARIZONA  
JUN 25 P 12:59



## EXHIBIT A

County: Graham

State: AZ

BLM Serial #	Claim Name	Original Recording		Amended Recording		Location
		Recording #	Page #	Recording #	Page #	
AMC 067657 7	Mas No. 9	249	269			SEC27-T06S-R26E
AMC 067658	Mas No. 10	249	270			SEC27-T06S-R26E
AMC 067659	Mas No. 11	249	271			SEC27-T06S-R26E
AMC 067660	Mas No. 12	249	272			SEC27-T06S-R26E
AMC 067661	Mas No. 13	249	273			SEC27-T06S-R26E
AMC 067662	Mas No. 14	249	274			SEC27-T06S-R26E
AMC 067663	Mas No. 15	249	275			SEC27-T06S-R26E
AMC 067664	Mas No. 16	249	276			SEC27-T06S-R26E
AMC 067665	Mas No. 17	249	277			SEC27-T06S-R26E
AMC 067666	Mas No. 18	249	278			SEC27-T06S-R26E
AMC 067667	Mas No. 19	249	279			SEC34-T06S-R26E
AMC 067668	Mas No. 20	249	280			SEC34-T06S-R26E
AMC 067669	Mas No. 21	249	281			SEC34-T06S-R26E
AMC 067670	Mas No. 22	249	282			SEC34-T06S-R26E
AMC 067671	Mas No. 23	249	283			SEC34-T06S-R26E
AMC 067672	Mas No. 24	249	284			SEC34-T06S-R26E
AMC 067673	Mas No. 25	249	285			SEC34-T06S-R26E
AMC 067674	Mas No. 26	249	286			SEC34-T06S-R26E
AMC 067675	Mas No. 27	249	287			SEC34-T06S-R26E
AMC 067676	Mas No. 28	249	288			SEC34-T06S-R26E
AMC 067677	Mas No. 29	249	289			SEC34-T06S-R26E
AMC 067678	Mas No. 30	249	290			SEC34-T06S-R26E
AMC 067679	Mas No. 31	249	291			SEC34-T06S-R26E
AMC 067680	Mas No. 32	249	292			SEC34-T06S-R26E
AMC 067681	Mas No. 33	249	293			SEC34-T06S-R26E
AMC 067682	Mas No. 34	249	294			SEC34-T06S-R26E
AMC 067683	Mas No. 35	249	295			SEC34-T06S-R26E
AMC 067684	Mas No. 36	249	296			SEC34-T06S-R26E
AMC 067685	Mas No. 45	249	297			SEC27-T06S-R26E
AMC 067686	Mas No. 46	249	298			SEC27-T06S-R26E
AMC 067687	Mas No. 47	249	299			SEC27-T06S-R26E
AMC 067688	Mas No. 48	249	300			SEC27-T06S-R26E
AMC 067689	Mas No. 49	249	301			SEC27-T06S-R26E
AMC 067690	Mas No. 50	249	302			SEC27-T06S-R26E
AMC 067691	Mas No. 51	249	303			SEC27-T06S-R26E
AMC 067692	Mas No. 52	249	304			SEC27-T06S-R26E
AMC 067693	Mas No. 53	249	305			SEC27-T06S-R26E
AMC 067694	Mas No. 54	249	306			SEC27-T06S-R26E

Date: 5/23/2018

RECEIVED  
BLM AZ STATE OFFICE  
JUN 25 12:59 PM  
PHOENIX, ARIZONA

## EXHIBIT A

County: Graham

State: AZ

<u>BLM Serial #</u>	<u>Claim Name</u>	<u>Original Recording</u>		<u>Amended Recording</u>		<u>Location</u>
		<u>Recording #</u>	<u>Page #</u>	<u>Recording #</u>	<u>Page #</u>	
AMC 067695	Mas No. 55	249	307			SEC27-T06S-R26E
AMC 067696	Mas No. 56	249	308			SEC27-T06S-R26E
AMC 067697	Mas No. 57	249	309			SEC27-T06S-R26E
AMC 067698	Mas No. 58	249	310			SEC27-T06S-R26E
AMC 067699	Mas No. 59	249	311			SEC27-T06S-R26E
AMC 067700	Mas No. 60	249	312			SEC27-T06S-R26E
AMC 067701	Mas No. 61	249	313			SEC27-T06S-R26E
AMC 067702	Mas No. 62	249	314			SEC27-T06S-R26E
AMC 067703	Mas No. 63	249	315			SEC27-T06S-R26E
AMC 067704	Mas No. 64	249	316			SEC27-T06S-R26E
AMC 067705	Mas No. 65	249	317			SEC27-T06S-R26E
AMC 067706	Mas No. 66	249	318			SEC27-T06S-R26E
AMC 067707	Mas No. 67	249	319			SEC27-T06S-R26E
AMC 067708	Mas No. 68	249	320			SEC27-T06S-R26E
AMC 067709	Mas No. 69	249	321			SEC27-T06S-R26E
AMC 067710	Mas No. 70	249	322			SEC27-T06S-R26E
AMC 067711	Mas No. 71	249	323			SEC27-T06S-R26E
AMC 067712	Mas No. 72	249	324			SEC34-T06S-R26E
AMC 067713	Mas No. 73	249	325			SEC28-T06S-R26E
AMC 067714	Mas No. 74	249	326			SEC28-T06S-R26E
AMC 067715	Mas No. 75	249	327			SEC28-T06S-R26E
AMC 067716	Mas No. 76	249	328			SEC28-T06S-R26E
AMC 067717	Mas No. 77	249	329			SEC28-T06S-R26E
AMC 067718	Mas No. 78	249	330			SEC28-T06S-R26E
AMC 067719	Mas No. 79	249	331			SEC28-T06S-R26E
AMC 067720	Mas No. 80	249	332			SEC28-T06S-R26E
AMC 067721	Mas No. 81	249	333			SEC28-T06S-R26E
AMC 067722	Mas No. 82	249	334			SEC28-T06S-R26E
AMC 067723	Mas No. 83	249	335			SEC33-T06S-R26E
AMC 067724	Mas No. 84	249	336			SEC33-T06S-R26E
AMC 067725	Mas No. 85	249	337			SEC33-T06S-R26E
AMC 067726	Mas No. 86	249	338			SEC33-T06S-R26E
AMC 067727	Mas No. 87	249	339			SEC33-T06S-R26E
AMC 067728	Mas No. 88	249	340			SEC33-T06S-R26E
AMC 067729	Mas No. 89	249	341			SEC33-T06S-R26E
AMC 067730	Mas No. 90	249	342			SEC33-T06S-R26E
AMC 067731	Mas No. 91	249	343			SEC33-T06S-R26E
AMC 067732	Mas No. 92	249	344			SEC33-T06S-R26E

Date: 5/23/2018

Page 8

RECEIVED  
BLM AZ STATE OFFICE  
PHOENIX, ARIZONA  
JUN 25 12:54 PM '18

## EXHIBIT A

County: Graham

State: AZ

BLM Serial #	Claim Name	Original Recording		Amended Recording		Location
		Recording #	Page #	Recording #	Page #	
AMC 067733	Mas No. 93	249	345			SEC33-T06S-R26E
AMC 067734	Mas No. 94	249	346			SEC33-T06S-R26E
AMC 067735	Mas No. 96	249	348			SEC33-T06S-R26E
AMC 067736	Mas No. 98	249	349			SEC33-T06S-R26E
AMC 067737	Mas No. 100	249	350			SEC33-T06S-R26E
AMC 067750	Epsilon No. 51	51	38			SEC09-T06S-R27E
AMC 067767	Garoga 16A	46	61	416	972	SEC10-T06S-R27E
AMC 067772	Garoga #21	46	56			SEC10-T06S-R27E
AMC 067773	Garoga #22	46	55			SEC10-T06S-R27E
AMC 067774	Garoga #23	46	54			SEC10-T06S-R27E
AMC 067775	Garoga #24	46	53			SEC10-T06S-R27E
AMC 067776	Garoga #25	46	52			SEC10-T06S-R27E
AMC 067829	Alpha 61A	46	22	420	29	SEC20-T06S-R27E
AMC 067831	Alpha 63A	46	24	420	33	SEC20-T06S-R27E
AMC 067833	Alpha 65A	46	26	420	37	SEC20-T06S-R27E
AMC 067835	Alpha 67A	46	28	420	41	SEC20-T06S-R27E
AMC 067837	Alpha #69	46	30			SEC20-T06S-R27E
AMC 067839	Alpha #71	46	32			SEC20-T06S-R27E
AMC 067841	Alpha #73	46	34			SEC20-T06S-R27E
AMC 101253	Ace 19A	324	272	414	31	SEC14-T06S-R26E
AMC 101254	Ace 20A	324	274	414	33	SEC14-T06S-R26E
AMC 101282	Ace 48A	324	330	410	397	SEC11-T06S-R26E
AMC 101283	Ace 49A	324	332	410	399	SEC11-T06S-R26E
AMC 101284	Ace 50A	324	334	410	401	SEC11-T06S-R26E
AMC 101285	Ace 51A	324	336	478	241	SEC11-T06S-R26E
AMC 101286	Ace 52A	324	338	478	243	SEC11-T06S-R26E
AMC 113312	Melody #2A	332	595			SEC11-T06S-R26E
AMC 113313	Melody #4A	332	596			SEC11-T06S-R26E
AMC 113314	Melody #6A	332	597			SEC11-T06S-R26E
AMC 113315	Melody #12A	332	598			SEC11-T06S-R26E
AMC 113316	Melody #14A	332	599			SEC11-T06S-R26E
AMC 113317	Melody #22A	332	600			SEC11-T06S-R26E
AMC 113318	Melody #24A	332	601			SEC11-T06S-R26E
AMC 113319	Melody #26A	332	602			SEC11-T06S-R26E
AMC 113320	Melody #28A	332	603			SEC11-T06S-R26E
AMC 113321	Melody #30A	332	604			SEC11-T06S-R26E
AMC 288506	GEM 252	409	77			SEC36-T06S-R27E
AMC 288507	GEM 253	409	79			SEC36-T06S-R27E

Date: 5/23/2018

RECEIVED  
BLM AZ STATE OFFICE  
PHOENIX, ARIZONA  
2018 JUN 25 P 12: 59

## EXHIBIT A

County: Graham

State: AZ

BLM Serial #	Claim Name	Original Recording		Amended Recording		Location
		Recording #	Page #	Recording #	Page #	
AMC 288508 7	GEM 254	409	80			SEC36-T06S-R27E
AMC 288509	GEM 255	409	81			SEC36-T06S-R27E
AMC 288510	GEM 256	409	82			SEC36-T06S-R27E
AMC 288511	GEM 257	409	83			SEC36-T06S-R27E
AMC 288512	GEM 258	409	84			SEC36-T06S-R27E
AMC 288513	GEM 259	409	85			SEC36-T06S-R27E
AMC 288514	GEM 260	409	86			SEC36-T06S-R27E
AMC 288515	GEM 261	409	87			SEC36-T06S-R27E
AMC 288516	GEM 262	409	88			SEC36-T06S-R27E
AMC 288517	GEM 263	409	89			SEC36-T06S-R27E
AMC 288518	GEM 264	409	90			SEC36-T06S-R27E
AMC 288519	GEM 265	409	91			SEC36-T06S-R27E
AMC 288520	GEM 266	409	92			SEC36-T06S-R27E
AMC 288521	GEM 267	409	93			SEC36-T06S-R27E
AMC 288522	GEM 268	409	94			SEC36-T06S-R27E
AMC 288523	GEM 269	409	95			SEC36-T06S-R27E
AMC 288524	GEM 270	409	96			SEC36-T06S-R27E
AMC 288525	GEM 271	409	97			SEC36-T06S-R27E
AMC 288526	GEM 272	409	98			SEC36-T06S-R27E
AMC 288527	GEM 273	409	99			SEC36-T06S-R27E
AMC 288528	GEM 274	409	100			SEC36-T06S-R27E
AMC 288529	GEM 275	409	101			SEC36-T06S-R27E
AMC 289500 7	LS-21	410	379			SEC14-T06S-R26E
AMC 289501	LS-22	410	381			SEC11-T06S-R26E
AMC 292727 7	AZCO #1 Amended	413	128	512	669	SEC33-T06S-R27E
AMC 292728	AZCO #2 Amended	413	130	512	671	SEC04-T07S-R27E
AMC 292729	AZCO #3 Amended	413	132	512	673	SEC33-T06S-R27E
AMC 292730	AZCO #4 Amended	413	134	512	675	SEC04-T07S-R27E
AMC 292731	AZCO #5 Amended	413	136	512	677	SEC33-T06S-R27E
AMC 292732	AZCO #6 Amended	413	138	512	679	SEC04-T07S-R27E
AMC 292733	AZCO #7 Amended	413	140	512	681	SEC33-T06S-R27E
AMC 292734	AZCO #8 Amended	413	142	512	683	SEC04-T07S-R27E
AMC 292735	AZCO #9 Amended	413	144	512	685	SEC33-T06S-R27E
AMC 292736	AZCO #10 Amended	413	146	512	687	SEC04-T07S-R27E
AMC 292737	AZCO #11 Amended	413	148	512	689	SEC33-T06S-R27E
AMC 292738	AZCO #12 Amended	413	150	512	691	SEC04-T07S-R27E
AMC 292739	AZCO #13 Amended	413	152	512	693	SEC33-T06S-R27E
AMC 292740	AZCO #14 Amended	413	154	512	695	SEC04-T07S-R27E

Date: 5/23/2018

Page 10

RECEIVED  
BLM AZ STATE OFFICE  
PHOENIX, ARIZONA  
2018 JUN 25 P 12:58

## EXHIBIT A

County: Graham

State: AZ

BLM Serial #	Claim Name	Original Recording		Amended Recording		
		Recording #	Page #	Recording #	Page #	Location
AMC 292741	AZCO #15 Amended	413	156	512	697	SEC33-T06S-R27E
AMC 292742	AZCO #16 Amended	413	158	512	699	SEC04-T07S-R27E
AMC 292743	AZCO #17 Amended	413	160	512	701	SEC33-T06S-R27E
AMC 292744	AZCO #18 Amended	413	162	512	703	SEC04-T07S-R27E
AMC 292759	AZCO #33 Amended	413	192	512	705	SEC33-T06S-R27E
AMC 292760	AZCO #34 Amended	413	194	512	707	SEC33-T06S-R27E
AMC 292761	AZCO #35 Amended	413	196	512	709	SEC33-T06S-R27E
AMC 292762	AZCO #36 Amended	413	198	512	711	SEC33-T06S-R27E
AMC 292763	AZCO #37 Amended	413	200	512	713	SEC33-T06S-R27E
AMC 292764	AZCO #38 Amended	413	202	512	715	SEC33-T06S-R27E
AMC 292765	AZCO #100 Amended	413	204	512	731	SEC33-T06S-R27E
AMC 292766	AZCO #101 Amended	413	206	512	733	SEC33-T06S-R27E
AMC 292767	AZCO #102 Amended	413	208	512	735	SEC33-T06S-R27E
AMC 292768	AZCO #103 Amended	413	210	512	737	SEC33-T06S-R27E
AMC 292769	AZCO #104 Amended	413	212	512	739	SEC33-T06S-R27E
AMC 292770	AZCO #105 Amended	413	214	512	741	SEC33-T06S-R27E
AMC 292771	AZCO #106 Amended	413	216	512	743	SEC33-T06S-R27E
AMC 292772	AZCO #107 Amended	413	218	512	745	SEC33-T06S-R27E
AMC 292773	AZCO #108 Amended	413	220	512	747	SEC33-T06S-R27E
AMC 292774	AZCO #109 Amended	413	222	512	749	SEC33-T06S-R27E
AMC 292775	AZCO #110 Amended	413	224	512	751	SEC33-T06S-R27E
AMC 292776	AZCO #111 Amended	413	226	512	753	SEC33-T06S-R27E
AMC 292777	AZCO #112 Amended	413	228	512	755	SEC33-T06S-R27E
AMC 292778	AZCO #113 Amended	413	230	512	757	SEC33-T06S-R27E
AMC 292791	AZCO #126 Amended	413	256	512	759	SEC27-T06S-R27E
AMC 292792	AZCO #127 Amended	413	258	512	761	SEC27-T06S-R27E
AMC 292793	AZCO #128 Amended	413	260	512	763	SEC34-T06S-R27E
AMC 292794	AZCO #129 Amended	413	262	512	765	SEC34-T06S-R27E
AMC 292795	AZCO #130 Amended	413	264	512	767	SEC34-T06S-R27E
AMC 292796	AZCO #131 Amended	413	266	512	769	SEC34-T06S-R27E
AMC 292797	AZCO #132 Amended	413	268	512	771	SEC34-T06S-R27E
AMC 292798	AZCO #133 Amended	413	270	512	773	SEC34-T06S-R27E
AMC 292799	AZCO #134 Amended	413	272	512	775	SEC34-T06S-R27E
AMC 292800	AZCO #135 Amended	413	274	512	777	SEC34-T06S-R27E
AMC 292801	AZCO #136 Amended	413	276	512	779	SEC34-T06S-R27E
AMC 292802	AZCO #137 Amended	413	278	512	781	SEC34-T06S-R27E
AMC 292803	AZCO #138 Amended	413	280	512	783	SEC34-T06S-R27E
AMC 292804	AZCO #139 Amended	413	282	512	785	SEC34-T06S-R27E

Date: 5/23/2018

RECEIVED  
BLM AZ STATE OFFICE  
PHOENIX, ARIZONA  
JUN 25 P 12:58 2018

# EXHIBIT A

County: Graham

State: AZ

BLM Serial #	Claim Name	Original Recording		Amended Recording		
		Recording #	Page #	Recording #	Page #	Location
AMC 292809 7	AZCO #144 Amended	413	292	512	787	SEC34-T06S-R27E
AMC 292810	AZCO #145 Amended	413	294	512	789	SEC34-T06S-R27E
AMC 292811	AZCO #146 Amended	413	296	512	791	SEC34-T06S-R27E
AMC 292812 J	AZCO #147 Amended	413	298	512	793	SEC34-T06S-R27E
AMC 292820 -	AZCO #155 Amended	413	314	512	795	SEC28-T06S-R27E
AMC 292822 -	AZCO #157 Amended	413	318	512	797	SEC28-T06S-R27E
AMC 292824 -	AZCO #159 Amended	413	322	512	799	SEC28-T06S-R27E
AMC 292826 -	AZCO #161 Amended	413	326	512	801	SEC28-T06S-R27E
AMC 292828 7	AZCO #163 Amended	413	330	512	803	SEC27-T06S-R27E
AMC 292829	AZCO #164 Amended	413	332	512	805	SEC27-T06S-R27E
AMC 292830	AZCO #165 Amended	413	334	512	807	SEC27-T06S-R27E
AMC 292831	AZCO #166 Amended	413	336	512	809	SEC27-T06S-R27E
AMC 292832	AZCO #167 Amended	413	338	512	811	SEC27-T06S-R27E
AMC 292833	AZCO #168 Amended	413	340	512	813	SEC27-T06S-R27E
AMC 292834	AZCO #169 Amended	413	342	512	815	SEC27-T06S-R27E
AMC 292835	AZCO #170 Amended	413	344	512	817	SEC27-T06S-R27E
AMC 292836	AZCO #171 Amended	413	346	512	819	SEC27-T06S-R27E
AMC 292837	AZCO #172 Amended	413	348	512	821	SEC27-T06S-R27E
AMC 292838	AZCO #173 Amended	413	350	512	823	SEC27-T06S-R27E
AMC 292839	AZCO #174 Amended	413	352	512	825	SEC27-T06S-R27E
AMC 292840	AZCO #175 Amended	413	354	512	827	SEC27-T06S-R27E
AMC 292841	AZCO #176 Amended	413	356	512	829	SEC27-T06S-R27E
AMC 292842	AZCO #177 Amended	413	358	512	831	SEC27-T06S-R27E
AMC 292843	AZCO #178 Amended	413	360	512	833	SEC27-T06S-R27E
AMC 292844	AZCO #179 Amended	413	362	512	835	SEC27-T06S-R27E
AMC 292845	AZCO #180 Amended	413	364	512	837	SEC26-T06S-R27E
AMC 292846	AZCO #181 Amended	413	366	512	839	SEC26-T06S-R27E
AMC 292847	AZCO #182 Amended	413	368	512	841	SEC26-T06S-R27E
AMC 292848 J	AZCO #183 Amended	413	370	512	843	SEC26-T06S-R27E
AMC 292850 T	AZCO #195 Amended	413	374	512	857	SEC27-T06S-R27E
AMC 292851	AZCO #196 Amended	413	376	512	859	SEC26-T06S-R27E
AMC 292852 J	AZCO #197 Amended	413	378	512	861	SEC26-T06S-R27E
AMC 292853 J	AZCO #198 Amended	413	380	512	863	SEC26-T06S-R27E
AMC 292856 -	AZCO #202 Amended	413	386	512	865	SEC35-T06S-R27E
AMC 293498 -	LS-36					SEC14-T06S-R26E
AMC 294150 L	AZCO #39 Amended	415	11	512	717	SEC33-T06S-R27E
AMC 294151	AZCO #40 Amended	415	11	512	719	SEC33-T06S-R27E
AMC 294152 L	AZCO #41 Amended	415	11	512	721	SEC33-T06S-R27E

Date: 5/23/2018

PHOENIX, ARIZONA  
 2018 JAN 25 P 12: 59

RECEIVED  
 BLM AZ STATE OFFICE

## EXHIBIT A

County: Graham

State: AZ

BLM Serial #	Claim Name	Original Recording		Amended Recording		
		Recording #	Page #	Recording #	Page #	Location
AMC 294153	AZCO #42 Amended	415	15	512	723	SEC33-T06S-R27E
AMC 294154	AZCO #43 Amended	415	17	512	725	SEC28-T06S-R27E
AMC 294155	AZCO #203 Amended	415	19	512	867	SEC28-T06S-R27E
AMC 294157	AZCO #205 Amended	415	23	512	869	SEC28-T06S-R27E
AMC 294159	AZCO #207 Amended	415	27	512	871	SEC28-T06S-R27E
AMC 294161	AZCO #209 Amended	415	31	512	873	SEC28-T06S-R27E
AMC 294167	AZCO #357 Amended	415	135	512	889	SEC24-T06S-R27E
AMC 294168	AZCO #359 Amended	415	137	512	893	SEC24-T06S-R27E
AMC 294169	AZCO #361 Amended	415	139	512	897	SEC24-T06S-R27E
AMC 294170	AZCO #363 Amended	415	141	512	901	SEC24-T06S-R27E
AMC 294171	AZCO #364 Amended	415	143	512	903	SEC24-T06S-R27E
AMC 294172	AZCO #365 Amended	415	145	512	905	SEC24-T06S-R27E
AMC 294173	AZCO #366 Amended	415	147	512	907	SEC24-T06S-R27E
AMC 294174	AZCO #367 Amended	415	149	512	909	SEC23-T06S-R27E
AMC 294175	AZCO #368 Amended	415	151	512	911	SEC23-T06S-R27E
AMC 294176	AZCO #369 Amended	415	153	512	913	SEC23-T06S-R27E
AMC 294177	AZCO #370 Amended	415	155	512	915	SEC23-T06S-R27E
AMC 294178	AZCO #371 Amended	415	157	512	917	SEC23-T06S-R27E
AMC 294179	AZCO #372 Amended	415	159	512	919	SEC23-T06S-R27E
AMC 294180	AZCO #373 Amended	415	161	512	921	SEC23-T06S-R27E
AMC 294181	AZCO #374 Amended	415	163	512	923	SEC23-T06S-R27E
AMC 294182	AZCO #375 Amended	415	165	512	925	SEC23-T06S-R27E
AMC 294183	AZCO #376 Amended	415	167	512	927	SEC23-T06S-R27E
AMC 294184	AZCO #377 Amended	415	169	512	929	SEC23-T06S-R27E
AMC 294185	AZCO #378 Amended	415	171	512	931	SEC23-T06S-R27E
AMC 294186	AZCO #379 Amended	415	173	512	933	SEC23-T06S-R27E
AMC 294187	AZCO #380 Amended	415	175	512	935	SEC23-T06S-R27E
AMC 294188	AZCO #381 Amended	415	177	512	937	SEC26-T06S-R27E
AMC 294189	AZCO #382 Amended	415	179	512	939	SEC26-T06S-R27E
AMC 294190	AZCO #383 Amended	415	181	512	941	SEC26-T06S-R27E
AMC 294191	AZCO #384 Amended	415	183	512	943	SEC26-T06S-R27E
AMC 294192	AZCO #300 Amended	415	43	512	875	SEC30-T06S-R27E
AMC 294193	AZCO #301 Amended	415	45	512	877	SEC30-T06S-R27E
AMC 294194	AZCO #302 Amended	415	47	512	879	SEC25-T06S-R27E
AMC 294195	AZCO #303 Amended	415	49	512	881	SEC25-T06S-R27E
AMC 294196	AZCO #304 Amended	415	51	512	883	SEC25-T06S-R27E
AMC 294197	AZCO #305 Amended	415	53	512	885	SEC30-T06S-R27E
AMC 294198	AZCO #306 Amended	415	55	512	887	SEC30-T06S-R27E

Date: 5/23/2018

RECEIVED  
 BLM AZ STATE OFFICE  
 PHOENIX, ARIZONA  
 2018 JUN 25 P 12:59



# EXHIBIT A

County: Graham

State: AZ

BLM Serial #	Claim Name	Original Recording		Amended Recording		
		Recording #	Page #	Recording #	Page #	Location
AMC 294348	LS-39	415	305			
AMC 294349	LS-40	415	319			SEC31-T05S-R27E
AMC 294350	LS-41	415	303			SEC31-T05S-R27E
AMC 298852	LS-53	419	998			SEC31-T05S-R27E
AMC 298855	LS-56	420	5			SEC20-T06S-R27E
AMC 298861	AZCO #44 Amended	419	636	512	727	SEC20-T06S-R27E
AMC 298862	AZCO #45 Amended	419	638	512	729	SEC34-T06S-R27E
AMC 298867	AZCO #185 Amended	419	634	512	845	SEC34-T06S-R27E
AMC 298868	AZCO #400 Amended	419	616	512	945	SEC26-T06S-R27E
AMC 298870	AZCO #402 Amended	419	620	512	947	SEC36-T06S-R27E
AMC 298876	AZCO #410 Amended	419	632	512	949	SEC36-T06S-R27E
AMC 298877	AZCO #411 Amended	419	648	512	949	SEC36-T06S-R27E
AMC 298878	AZCO #412 Amended	419	650	512	951	SEC29-T06S-R27E
AMC 298879	AZCO #413 Amended	419	652	512	953	SEC29-T06S-R27E
AMC 298880	AZCO #414 Amended	419	652	512	955	SEC29-T06S-R27E
AMC 298881	AZCO #415 Amended	419	654	512	957	SEC29-T06S-R27E
AMC 298882	AZCO #416 Amended	419	656	512	959	SEC29-T06S-R27E
AMC 298883	AZCO #417 Amended	419	658	512	961	SEC29-T06S-R27E
AMC 298884	AZCO #418 Amended	419	660	512	963	SEC29-T06S-R27E
AMC 298885	AZCO #419 Amended	419	662	512	965	SEC29-T06S-R27E
AMC 298886	AZCO #420 Amended	419	664	512	967	SEC29-T06S-R27E
AMC 298887	AZCO #421 Amended	419	666	512	969	SEC29-T06S-R27E
AMC 298888	AZCO #422 Amended	419	668	512	971	SEC29-T06S-R27E
AMC 298889	AZCO #423 Amended	419	670	512	973	SEC29-T06S-R27E
AMC 298890	AZCO #424 Amended	419	672	512	975	SEC29-T06S-R27E
AMC 298891	AZCO #425 Amended	419	674	512	977	SEC29-T06S-R27E
AMC 298892	AZCO #426 Amended	419	676	512	979	SEC29-T06S-R27E
AMC 298893	AZCO #427 Amended	419	678	512	981	SEC29-T06S-R27E
AMC 298894	AZCO #428 Amended	419	680	512	983	SEC29-T06S-R27E
AMC 298895	AZCO #429 Amended	419	682	512	985	SEC29-T06S-R27E
AMC 298896	AZCO #430 Amended	419	684	512	987	SEC29-T06S-R27E
AMC 298897	AZCO #461 Amended	419	686	512	989	SEC29-T06S-R27E
AMC 298898	AZCO #462 Amended	419	708	513	11	SEC28-T06S-R27E
AMC 298899	AZCO #463 Amended	419	710	513	13	SEC28-T06S-R27E
AMC 298929	AZCO #190 Amended	419	712	513	15	SEC28-T06S-R27E
AMC 298930	AZCO #191 Amended	419	818	512	847	SEC27-T06S-R27E
AMC 298931	AZCO #192 Amended	419	820	512	849	SEC27-T06S-R27E
AMC 298932	AZCO #193 Amended	419	822	512	851	SEC27-T06S-R27E
		419	824	512	853	SEC27-T06S-R27E

Date: 5/23/2018

RECEIVED  
BLM AZ STATE OFFICE

### EXHIBIT A

County: Graham

State: AZ

BLM Serial #	Claim Name	Original Recording		Amended Recording		
		Recording #	Page #	Recording #	Page #	Location
AMC 298933 7	AZCO #194 Amended	419	826	512	855	SEC27-T06S-R27E
AMC 298934	AZCO #358 Amended	419	828	512	891	SEC24-T06S-R27E
AMC 298935	AZCO #360 Amended	419	830	512	895	SEC24-T06S-R27E
AMC 298936 )	AZCO #362 Amended	419	832	512	899	SEC24-T06S-R27E
AMC 305755 7	AZCO #441 Amended	426	703	512	991	SEC29-T06S-R27E
AMC 305756	AZCO #442 Amended	426	705	512	993	SEC29-T06S-R27E
AMC 305757	AZCO #443 Amended	426	707	512	995	SEC29-T06S-R27E
AMC 305758	AZCO #444 Amended	426	709	512	997	SEC21-T06S-R27E
AMC 305759	AZCO #445 Amended	426	711	512	999	SEC20-T06S-R27E
AMC 305760	AZCO #446 Amended	426	713	513	1	SEC20-T06S-R27E
AMC 305761	AZCO #447 Amended	426	715	513	03	SEC20-T06S-R27E
AMC 305762	AZCO #448 Amended	426	717	513	05	SEC20-T06S-R27E
AMC 305763	AZCO #449 Amended	426	719	513	07	SEC20-T06S-R27E
AMC 305764 }	AZCO #450 Amended	426	721	513	09	SEC20-T06S-R27E
AMC 321860 7	M1	448	441			SEC15-T06S-R27E
AMC 321861	M2	448	443			SEC15-T06S-R27E
AMC 321862	M3	448	445			SEC15-T06S-R27E
AMC 321863	M4	448	447			SEC15-T06S-R27E
AMC 321864	M5	448	449			SEC15-T06S-R27E
AMC 321865	M6	448	451			SEC15-T06S-R27E
AMC 321866	M7	448	453			SEC15-T06S-R27E
AMC 321867	M8	448	455			SEC15-T06S-R27E
AMC 321868	M9	448	457			SEC15-T06S-R27E
AMC 321869	M10	448	459			SEC15-T06S-R27E
AMC 321870	M11	448	461			SEC15-T06S-R27E
AMC 321871	M12	448	463			SEC15-T06S-R27E
AMC 321872	M13	448	465			SEC15-T06S-R27E
AMC 321873	M14	448	467			SEC15-T06S-R27E
AMC 321874	M15	448	469			SEC15-T06S-R27E
AMC 321875	M16	448	471			SEC15-T06S-R27E
AMC 321876	M17	448	473			SEC15-T06S-R27E
AMC 321877	M18	448	475			SEC15-T06S-R27E
AMC 321878	M37	448	477			SEC10-T06S-R27E
AMC 321879	M38	448	479			SEC10-T06S-R27E
AMC 321880	M39	448	481			SEC15-T06S-R27E
AMC 321881	M40	448	483			SEC15-T06S-R27E
AMC 321882	M41	448	485			SEC15-T06S-R27E
AMC 321883 }	M42	448	487			SEC15-T06S-R27E

Date: 5/23/2018

RECEIVED  
 BLM AZ STATE OFFICE  
 2018 JUN 25 P 1:00  
 PHOENIX, ARIZONA

### EXHIBIT A

County: Graham

State: AZ

BLM Serial #	Claim Name	Original Recording		Amended Recording		
		Recording #	Page #	Recording #	Page #	Location
AMC 321884	M43	448	489			
AMC 321885	M44	448	491			SEC15-T06S-R27E
AMC 321886	M45	448	493			SEC15-T06S-R27E
AMC 321887	M46	448	495			SEC15-T06S-R27E
AMC 321888	M47	448	497			SEC15-T06S-R27E
AMC 321889	M48	448	499			SEC15-T06S-R27E
AMC 321890	M49	448	501			SEC15-T06S-R27E
AMC 321891	M50	448	503			SEC15-T06S-R27E
AMC 321892	M51	448	505			SEC15-T06S-R27E
AMC 321893	M52	448	507			SEC15-T06S-R27E
AMC 321894	M53	448	509			SEC15-T06S-R27E
AMC 321895	M54	448	511			SEC15-T06S-R27E
AMC 321896	M73	448	513			SEC15-T06S-R27E
AMC 321897	M74	448	515			SEC10-T06S-R27E
AMC 321898	M75	448	517			SEC10-T06S-R27E
AMC 321899	M76	448	519			SEC10-T06S-R27E
AMC 321900	M77	448	521			SEC10-T06S-R27E
AMC 321901	M78	448	523			SEC10-T06S-R27E
AMC 321902	M79	448	525			SEC10-T06S-R27E
AMC 321903	M80	448	527			SEC10-T06S-R27E
AMC 321904	M81	448	529			SEC10-T06S-R27E
AMC 321905	M82	448	531			SEC10-T06S-R27E
AMC 321906	M83	448	533			SEC10-T06S-R27E
AMC 321907	M84	448	535			SEC10-T06S-R27E
AMC 321908	M85	448	537			SEC10-T06S-R27E
AMC 321909	M86	448	539			SEC10-T06S-R27E
AMC 321910	M87	448	541			SEC10-T06S-R27E
AMC 321911	M88	448	543			SEC11-T06S-R27E
AMC 321912	M89	448	545			SEC11-T06S-R27E
AMC 321913	M90	448	547			SEC11-T06S-R27E
AMC 321914	M91	448	549			SEC11-T06S-R27E
AMC 321915	M92	448	551			SEC11-T06S-R27E
AMC 321916	M93	448	553			SEC11-T06S-R27E
AMC 321917	M94	448	555			SEC11-T06S-R27E
AMC 321918	M95	448	557			SEC11-T06S-R27E
AMC 321919	M96	448	559			SEC11-T06S-R27E
AMC 321920	M97	448	561			SEC11-T06S-R27E
AMC 321921	M98	448	563			SEC11-T06S-R27E

Date: 5/23/2018

PHOENIX, ARIZONA  
2018 JUN 25 P 1:00

RECEIVED  
BLM AZ STATE OFFICE

**EXHIBIT A**

County: Graham

State: AZ

BLM Serial #	Claim Name	Original Recording		Amended Recording		
		Recording #	Page #	Recording #	Page #	Location
AMC 321922	M99	448	565			
AMC 321923	M100	448	567			SEC11-T06S-R27E
AMC 321924	M101	448	569			SEC11-T06S-R27E
AMC 321925	M102	448	571			SEC11-T06S-R27E
AMC 321926	M103	448	573			SEC11-T06S-R27E
AMC 321927	M104	448	575			SEC11-T06S-R27E
AMC 321928	M105	448	577			SEC11-T06S-R27E
AMC 321929	M106	448	579			SEC10-T06S-R27E
AMC 321930	M107	448	581			SEC10-T06S-R27E
AMC 321931	M108	448	583			SEC10-T06S-R27E
AMC 321932	M109	448	585			SEC10-T06S-R27E
AMC 321933	M110	448	587			SEC10-T06S-R27E
AMC 321934	M111	448	589			SEC11-T06S-R27E
AMC 321935	M112	448	589			SEC11-T06S-R27E
AMC 321936	M113	448	591			SEC11-T06S-R27E
AMC 321937	M114	448	593			SEC11-T06S-R27E
AMC 321938	M115	448	595			SEC11-T06S-R27E
AMC 321939	M116	448	597			SEC11-T06S-R27E
AMC 321940	M117	448	599			SEC11-T06S-R27E
AMC 321941	M118	448	601			SEC11-T06S-R27E
AMC 321942	M119	448	603			SEC11-T06S-R27E
AMC 321943	M120	448	605			SEC11-T06S-R27E
AMC 321944	M121	448	607			SEC10-T06S-R27E
AMC 321945	M122	448	609			SEC10-T06S-R27E
AMC 321946	M123	448	611			SEC11-T06S-R27E
AMC 321947	M124	448	613			SEC11-T06S-R27E
AMC 324229	M56	448	615			SEC11-T06S-R27E
AMC 324230	M58	452	54			SEC11-T06S-R27E
AMC 324231	M60	452	56			SEC11-T06S-R27E
AMC 324232	M62	452	58			SEC14-T06S-R27E
AMC 324233	M64	452	60			SEC11-T06S-R27E
AMC 324234	M66	452	62			SEC11-T06S-R27E
AMC 324235	M68	452	64			SEC11-T06S-R27E
AMC 324236	M70	452	66			SEC11-T06S-R27E
AMC 324237	M72	452	68			SEC11-T06S-R27E
AMC 324367	AZCO #465 Amended	449	937	513	17	SEC28-T06S-R27E
AMC 324368	AZCO #466 Amended	449	939	513	19	SEC28-T06S-R27E
AMC 324369	AZCO #467 Amended	449	941	513	21	SEC28-T06S-R27E

Date: 5/23/2018

RECEIVED  
 BLM AZ STATE OFFICE  
 PHOENIX, ARIZONA  
 JUN 25 2018

## EXHIBIT A

County: Graham

State: AZ

BLM Serial #	Claim Name	Original Recording		Amended Recording		
		Recording #	Page #	Recording #	Page #	Location
AMC 324370	AZCO #468 Amended	449	943	513	23	SEC28-T06S-R27E
AMC 324371	AZCO #469 Amended	449	945	513	25	SEC21-T06S-R27E
AMC 324892	MG 121	453	901			SEC30-T05S-R26E
AMC 324893	MG 122	453	903			SEC30-T05S-R26E
AMC 324894	MG 123	453	905			SEC30-T05S-R26E
AMC 324895	MG 124	453	907			SEC30-T05S-R26E
AMC 324896	MG 125	453	909			SEC30-T05S-R26E
AMC 324897	MG 126	453	911			SEC30-T05S-R26E
AMC 324898	MG 127	453	913			SEC30-T05S-R26E
AMC 324899	MG 128	453	915			SEC30-T05S-R26E
AMC 324900	MG 129	453	917			SEC30-T05S-R26E
AMC 324901	MG 130	453	919			SEC30-T05S-R26E
AMC 324902	MG 179	453	933			SEC30-T05S-R26E
AMC 324903	MG 180	453	935			SEC25-T05S-R25E
AMC 324904	MG 181	453	937			SEC25-T05S-R25E
AMC 324905	MG 182	453	939			SEC25-T05S-R25E
AMC 324906	MG 183	453	941			SEC25-T05S-R25E
AMC 324907	MG 184	453	943			SEC25-T05S-R25E
AMC 324908	MG 185	453	945			SEC25-T05S-R25E
AMC 324909	MG 186	453	947			SEC25-T05S-R25E
AMC 324910	MG 187	453	949			SEC25-T05S-R25E
AMC 324911	MG 188	453	951			SEC25-T05S-R25E
AMC 324912	MG 189	453	953			SEC25-T05S-R25E
AMC 324913	MG 190	453	955			SEC25-T05S-R25E
AMC 324914	MG 191	453	957			SEC25-T05S-R25E
AMC 324915	MG 192	453	959			SEC25-T05S-R25E
AMC 324916	MG 193	453	961			SEC25-T05S-R25E
AMC 324917	MG 194	453	963			SEC25-T05S-R25E
AMC 324918	MG 195	453	965			SEC25-T05S-R25E
AMC 324919	MG 196	453	967			SEC25-T05S-R25E
AMC 324920	MG 223	453	969			SEC25-T05S-R25E
AMC 324921	MG 224	453	971			SEC25-T05S-R25E
AMC 324922	MG 225	453	973			SEC25-T05S-R25E
AMC 324923	MG 226	453	975			SEC25-T05S-R25E
AMC 324924	MG 227	453	977			SEC25-T05S-R25E
AMC 324925	MG 228	453	979			SEC25-T05S-R25E
AMC 324926	MG 229	453	981			SEC25-T05S-R25E
AMC 324927	MG 230	453	983			SEC25-T05S-R25E

Date: 5/23/2018

RECEIVED  
 BLM AZ STATE OFFICE  
 PHOENIX, ARIZONA  
 JUN 25 11:00 AM 2018

# EXHIBIT A

County: Graham

State: AZ

BLM Serial #	Claim Name	Original Recording		Amended Recording		
		Recording #	Page #	Recording #	Page #	Location
AMC 324928	MG 231	453	985			SEC25-T05S-R25E
AMC 324929	MG 232	453	987			SEC25-T05S-R25E
AMC 324930	MG 233	453	989			SEC25-T05S-R25E
AMC 324931	MG 234	453	991			SEC25-T05S-R25E
AMC 324932	MG 235	453	993			SEC25-T05S-R25E
AMC 324933	MG 236	453	995			SEC25-T05S-R25E
AMC 324934	MG 237	453	997			SEC25-T05S-R25E
AMC 324935	MG 238	453	999			SEC25-T05S-R25E
AMC 324936	MG 239	453	999			SEC25-T05S-R25E
AMC 324937	MG 240	454	1			SEC25-T05S-R25E
AMC 326065	SOB 1	454	2A			SEC25-T05S-R25E
AMC 326066	SOB 2	458	703			SEC25-T05S-R25E
AMC 326067	SOB 3	458	704			SEC27-T06S-R27E
AMC 326068	SOB 4	458	705			SEC27-T06S-R27E
AMC 326069	SOB 5	458	706			SEC27-T06S-R27E
AMC 326070	SOB 6	458	707			SEC27-T06S-R27E
AMC 326071	SOB 7	458	708			SEC27-T06S-R27E
AMC 326072	SOB 8	458	709			SEC27-T06S-R27E
AMC 326073	SOB 9	458	710			SEC27-T06S-R27E
AMC 326074	SOB 10	458	711			SEC27-T06S-R27E
AMC 326075	SOB 11	458	712			SEC27-T06S-R27E
AMC 326076	SOB 12	458	713			SEC27-T06S-R27E
AMC 326077	SOB 13	458	714			SEC27-T06S-R27E
AMC 326078	SOB 14	458	715			SEC27-T06S-R27E
AMC 326079	SOB 15	458	716			SEC29-T06S-R27E
AMC 326080	SOB 16	458	717			SEC29-T06S-R27E
AMC 326081	SOB 17	458	718			SEC29-T06S-R27E
AMC 326082	SOB 18	458	719			SEC29-T06S-R27E
AMC 326083	SOB 19	458	720			SEC29-T06S-R27E
AMC 326084	SOB 20	458	721			SEC29-T06S-R27E
AMC 326085	SOB 21	458	722			SEC20-T06S-R27E
AMC 326086	SOB 22	458	723			SEC20-T06S-R27E
AMC 326087	SOB 23	458	724			SEC20-T06S-R27E
AMC 326088	SOB 24	458	725			SEC20-T06S-R27E
AMC 326089	SOB 25	458	726			SEC29-T06S-R27E
AMC 326090	SOB 26	458	727			SEC29-T06S-R27E
AMC 326091	SOB 27	458	728			SEC29-T06S-R27E
AMC 326092	SOB 28	458	729			SEC29-T06S-R27E
		458	730			SEC29-T06S-R27E

Date: 5/23/2018

RECEIVED  
 BLM AZ STATE OFFICE  
 PHOENIX, ARIZONA  
 2018 JUN 25 P 1:00

**EXHIBIT A**

County: Graham

State: AZ

<u>BLM Serial #</u>	<u>Claim Name</u>	<u>Original Recording</u>		<u>Amended Recording</u>		
		<u>Recording #</u>	<u>Page #</u>	<u>Recording #</u>	<u>Page #</u>	<u>Location</u>
AMC 326093	SOB 29	458	731			
AMC 326094	SOB 30	458	732			SEC29-T06S-R27E
AMC 326095	SOB 31	458	733			SEC29-T06S-R27E
AMC 326096	SOB 32	458	734			SEC29-T06S-R27E
AMC 326097	SOB 33	458	735			SEC29-T06S-R27E
AMC 326098	SOB 34	458	736			SEC29-T06S-R27E
AMC 326099	SOB 35	458	737			SEC29-T06S-R27E
AMC 326100	SOB 36	458	738			SEC29-T06S-R27E
AMC 326101	SOB 37	458	739			SEC29-T06S-R27E
AMC 326102	SOB 38	458	740			SEC29-T06S-R27E
AMC 326103	SOB 39	458	741			SEC29-T06S-R27E
AMC 326104	SOB 40	458	742			SEC29-T06S-R27E
AMC 326105	SOB 41	458	743			SEC29-T06S-R27E
AMC 326106	SOB 42	458	744			SEC29-T06S-R27E
AMC 326107	SOB 43	458	745			SEC29-T06S-R27E
AMC 326108	SOB 44	458	746			SEC29-T06S-R27E
AMC 326109	SOB 45	458	747			SEC29-T06S-R27E
AMC 326110	SOB 46	458	748			SEC29-T06S-R27E
AMC 326111	SOB 47	458	749			SEC29-T06S-R27E
AMC 326112	SOB 48	458	750			SEC21-T06S-R27E
AMC 326113	SOB 49	458	751			SEC21-T06S-R27E
AMC 326114	SOB 50	458	752			SEC21-T06S-R27E
AMC 326115	SOB 51	458	753			SEC21-T06S-R27E
AMC 326116	SOB 52	458	754			SEC28-T06S-R27E
AMC 326117	SOB 53	458	755			SEC28-T06S-R27E
AMC 326118	SOB 54	458	756			SEC28-T06S-R27E
AMC 326119	SOB 55	458	757			SEC28-T06S-R27E
AMC 326120	SOB 56	458	758			SEC28-T06S-R27E
AMC 326121	SOB 57	458	759			SEC28-T06S-R27E
AMC 326122	SOB 58	458	760			SEC28-T06S-R27E
AMC 326123	SOB 59	458	761			SEC28-T06S-R27E
AMC 326124	SOB 60	458	762			SEC28-T06S-R27E
AMC 326125	SOB 61	458	763			SEC28-T06S-R27E
AMC 326126	SOB 62	458	764			SEC28-T06S-R27E
AMC 326127	SOB 63	458	765			SEC28-T06S-R27E
AMC 326128	SOB 64	458	766			SEC28-T06S-R27E
AMC 326129	SOB 65	458	767			SEC28-T06S-R27E
AMC 326130	SOB 66	458	768			SEC28-T06S-R27E

Date: 5/23/2018

RECEIVED  
BLM AZ STATE OFFICE  
PHOENIX, ARIZONA  
2018 JUN 25 P 1:00

# EXHIBIT A

County: Graham

State: AZ

BLM Serial #	Claim Name	Original Recording		Amended Recording		
		Recording #	Page #	Recording #	Page #	Location
AMC 326131	SOB 67	458	769			SEC28-T06S-R27E
AMC 326132	SOB 68	458	770			SEC28-T06S-R27E
AMC 326133	SOB 69	458	771			SEC28-T06S-R27E
AMC 326134	SOB 70	458	772			SEC28-T06S-R27E
AMC 326135	SOB 71	458	773			SEC28-T06S-R27E
AMC 326136	SOB 72	458	774			SEC28-T06S-R27E
AMC 326137	SOB 73	458	775			SEC28-T06S-R27E
AMC 326138	SOB 74	458	776			SEC28-T06S-R27E
AMC 326139	SOB 75	458	777			SEC28-T06S-R27E
AMC 326140	SOB 76	458	778			SEC28-T06S-R27E
AMC 326141	SOB 77	458	779			SEC28-T06S-R27E
AMC 326142	SOB 78	458	780			SEC21-T06S-R27E
AMC 326143	SOB 79	458	781			SEC21-T06S-R27E
AMC 326144	SOB 80	458	782			SEC28-T06S-R27E
AMC 326145	SOB 81	458	783			SEC28-T06S-R27E
AMC 326146	SOB 82	458	784			SEC28-T06S-R27E
AMC 326147	SOB 83	458	785			SEC28-T06S-R27E
AMC 326148	SOB 84	458	786			SEC28-T06S-R27E
AMC 326149	SOB 85	458	787			SEC28-T06S-R27E
AMC 326150	SOB 86	458	788			SEC28-T06S-R27E
AMC 326151	SOB 87	458	789			SEC28-T06S-R27E
AMC 326152	SOB 88	458	790			SEC28-T06S-R27E
AMC 326153	SOB 89	458	791			SEC28-T06S-R27E
AMC 326154	SOB 90	458	792			SEC28-T06S-R27E
AMC 326155	SOB 91	458	793			SEC28-T06S-R27E
AMC 326156	SOB 92	458	794			SEC28-T06S-R27E
AMC 326157	SOB 93	458	795			SEC28-T06S-R27E
AMC 326158	SOB 94	458	796			SEC28-T06S-R27E
AMC 326159	SOB 95	458	797			SEC28-T06S-R27E
AMC 326160	SOB 96	458	798			SEC28-T06S-R27E
AMC 326161	SOB 97	458	799			SEC28-T06S-R27E
AMC 326162	SOB 98	458	800			SEC28-T06S-R27E
AMC 326163	SOB 99	458	801			SEC28-T06S-R27E
AMC 326164	SOB 100	458	802			SEC28-T06S-R27E
AMC 326165	SOB 101	458	803			SEC28-T06S-R27E
AMC 326166	SOB 102	458	804			SEC28-T06S-R27E
AMC 326167	SOB 103	458	805			SEC28-T06S-R27E
AMC 326168	SOB 104	458	806			SEC28-T06S-R27E

Date: 5/23/2018

PHOENIX, ARIZONA

JUN 25 P 1:00 2018

RECEIVED  
BLM AZ STATE OFFICE



# EXHIBIT A

County: Graham

State: AZ

<u>BLM Serial #</u>	<u>Claim Name</u>	<u>Original Recording</u>		<u>Amended Recording</u>		
		<u>Recording #</u>	<u>Page #</u>	<u>Recording #</u>	<u>Page #</u>	<u>Location</u>
AMC 326169	SOB 105	458	807			
AMC 326170	SOB 106	458	808			SEC28-T06S-R27E
AMC 326171	SOB 107	458	809			SEC28-T06S-R27E
AMC 326172	SOB 108	458	810			SEC28-T06S-R27E
AMC 326173	SOB 109	458	811			SEC28-T06S-R27E
AMC 326174	SOB 110	458	812			SEC28-T06S-R27E
AMC 326175	SOB 111	458	813			SEC28-T06S-R27E
AMC 326176	SOB 112	458	814			SEC33-T06S-R27E
AMC 326177	SOB 113	458	815			SEC33-T06S-R27E
AMC 326178	SOB 114	458	816			SEC33-T06S-R27E
AMC 326179	SOB 115	458	817			SEC33-T06S-R27E
AMC 326180	SOB 116	458	818			SEC28-T06S-R27E
AMC 326181	SOB 117	458	819			SEC28-T06S-R27E
AMC 326182	SOB 118	458	820			SEC28-T06S-R27E
AMC 326183	SOB 119	458	821			SEC28-T06S-R27E
AMC 326184	SOB 120	458	822			SEC28-T06S-R27E
AMC 326185	SOB 121	458	823			SEC28-T06S-R27E
AMC 326186	SOB 122	458	824			SEC28-T06S-R27E
AMC 326187	SOB 123	458	825			SEC28-T06S-R27E
AMC 326188	SOB 124	458	826			SEC28-T06S-R27E
AMC 326189	SOB 125	458	827			SEC28-T06S-R27E
AMC 326190	SOB 126	458	828			SEC28-T06S-R27E
AMC 326191	SOB 127	458	829			SEC28-T06S-R27E
AMC 326192	SOB 128	458	830			SEC28-T06S-R27E
AMC 326193	SOB 129	458	831			SEC28-T06S-R27E
AMC 326194	SOB 130	458	832			SEC28-T06S-R27E
AMC 326195	SOB 131	458	833			SEC28-T06S-R27E
AMC 326196	SOB 132	458	834			SEC28-T06S-R27E
AMC 326197	SOB 133	458	835			SEC28-T06S-R27E
AMC 326198	SOB 134	458	836			SEC28-T06S-R27E
AMC 326199	SOB 135	458	837			SEC28-T06S-R27E
AMC 326200	SOB 136	458	838			SEC28-T06S-R27E
AMC 326201	SOB 137	458	839			SEC28-T06S-R27E
AMC 326202	SOB 138	458	840			SEC28-T06S-R27E
AMC 326203	SOB 139	458	841			SEC28-T06S-R27E
AMC 326204	SOB 140	458	842			SEC28-T06S-R27E
AMC 326205	SOB 141	458	843			SEC28-T06S-R27E
AMC 326206	SOB 142	458	844			SEC28-T06S-R27E

Date: 5/23/2018

RECEIVED  
BLM AZ STATE OFFICE  
PHOENIX, ARIZONA  
JUN 25 P 1:00

## EXHIBIT A

County: Graham

State: AZ

<u>BLM Serial #</u>	<u>Claim Name</u>	<u>Original Recording</u>		<u>Amended Recording</u>		<u>Location</u>
		<u>Recording #</u>	<u>Page #</u>	<u>Recording #</u>	<u>Page #</u>	
AMC 326207	SOB 143	458	845			SEC28-T06S-R27E
AMC 326208	SOB 144	458	846			SEC28-T06S-R27E
AMC 326209	SOB 145	458	847			SEC28-T06S-R27E
AMC 326210	SOB 146	458	848			SEC33-T06S-R27E
AMC 326211	SOB 147	458	849			SEC33-T06S-R27E
AMC 326212	SOB 148	458	850			SEC33-T06S-R27E
AMC 326213	SOB 149	458	851			SEC33-T06S-R27E
AMC 326214	SOB 150	458	852			SEC33-T06S-R27E
AMC 326215	SOB 151	458	853			SEC33-T06S-R27E
AMC 326216	SOB 152	458	854			SEC28-T06S-R27E
AMC 326217	SOB 153	458	855			SEC28-T06S-R27E
AMC 326218	SOB 154	458	856			SEC28-T06S-R27E
AMC 326219	SOB 155	458	857			SEC28-T06S-R27E
AMC 326220	SOB 156	458	858			SEC28-T06S-R27E
AMC 326221	SOB 157	458	859			SEC28-T06S-R27E
AMC 326222	SOB 158	458	860			SEC28-T06S-R27E
AMC 326223	SOB 159	458	861			SEC28-T06S-R27E
AMC 326224	SOB 160	458	862			SEC28-T06S-R27E
AMC 326225	SOB 161	458	863			SEC28-T06S-R27E
AMC 326226	SOB 162	458	864			SEC28-T06S-R27E
AMC 326227	SOB 163	458	865			SEC28-T06S-R27E
AMC 326228	SOB 164	458	866			SEC28-T06S-R27E
AMC 326229	SOB 165	458	867			SEC28-T06S-R27E
AMC 326230	SOB 166	458	868			SEC28-T06S-R27E
AMC 326231	SOB 167	458	869			SEC28-T06S-R27E
AMC 326232	SOB 168	458	870			SEC28-T06S-R27E
AMC 326233	SOB 169	458	871			SEC28-T06S-R27E
AMC 326234	SOB 170	458	872			SEC28-T06S-R27E
AMC 326235	SOB 171	458	873			SEC28-T06S-R27E
AMC 326236	SOB 172	458	874			SEC28-T06S-R27E
AMC 326237	SOB 173	458	875			SEC28-T06S-R27E
AMC 326238	SOB 174	458	876			SEC28-T06S-R27E
AMC 326239	SOB 175	458	877			SEC28-T06S-R27E
AMC 326240	SOB 176	458	878			SEC28-T06S-R27E
AMC 326241	SOB 177	458	879			SEC28-T06S-R27E
AMC 326242	SOB 178	458	880			SEC28-T06S-R27E
AMC 326243	SOB 179	458	881			SEC28-T06S-R27E
AMC 326244	SOB 180	458	882			SEC33-T06S-R27E

Date: 5/23/2018

Page 23

RECEIVED  
BLM AZ STATE OFFICE  
2018 JUN 25 P 1:00  
PHOENIX, ARIZONA

## EXHIBIT A

County: Graham

State: AZ

<u>BLM Serial #</u>	<u>Claim Name</u>	<u>Original Recording</u>		<u>Amended Recording</u>		<u>Location</u>
		<u>Recording #</u>	<u>Page #</u>	<u>Recording #</u>	<u>Page #</u>	
AMC 326245	SOB 181	458	883			SEC33-T06S-R27E
AMC 326246	SOB 182	458	884			SEC33-T06S-R27E
AMC 326247	SOB 183	458	885			SEC33-T06S-R27E
AMC 326248	SOB 184	458	886			SEC33-T06S-R27E
AMC 326249	SOB 185	458	887			SEC33-T06S-R27E
AMC 326250	SOB 186	458	888			SEC33-T06S-R27E
AMC 326251	SOB 187	458	889			SEC33-T06S-R27E
AMC 326252	SOB 188	458	890			SEC27-T06S-R27E
AMC 326253	SOB 189	458	891			SEC27-T06S-R27E
AMC 326254	SOB 190	458	892			SEC27-T06S-R27E
AMC 326255	SOB 191	458	893			SEC27-T06S-R27E
AMC 326256	SOB 192	458	894			SEC27-T06S-R27E
AMC 326257	SOB 193	458	895			SEC27-T06S-R27E
AMC 326258	SOB 194	458	896			SEC27-T06S-R27E
AMC 326259	SOB 195	458	897			SEC27-T06S-R27E
AMC 326260	SOB 196	458	898			SEC27-T06S-R27E
AMC 326261	SOB 197	458	899			SEC27-T06S-R27E
AMC 326262	SOB 198	458	900			SEC27-T06S-R27E
AMC 326263	SOB 199	458	901			SEC27-T06S-R27E
AMC 326264	SOB 200	458	902			SEC27-T06S-R27E
AMC 326265	SOB 201	458	903			SEC27-T06S-R27E
AMC 326266	SOB 202	458	904			SEC27-T06S-R27E
AMC 326267	SOB 203	458	905			SEC27-T06S-R27E
AMC 326268	SOB 204	458	906			SEC27-T06S-R27E
AMC 326269	SOB 205	458	907			SEC27-T06S-R27E
AMC 326270	SOB 206	458	908			SEC27-T06S-R27E
AMC 326271	SOB 207	458	909			SEC27-T06S-R27E
AMC 326272	SOB 208	458	910			SEC27-T06S-R27E
AMC 326273	SOB 209	458	911			SEC27-T06S-R27E
AMC 326274	SOB 210	458	912			SEC27-T06S-R27E
AMC 326275	SOB 211	458	913			SEC27-T06S-R27E
AMC 326276	SOB 212	458	914			SEC27-T06S-R27E
AMC 326277	SOB 213	458	915			SEC34-T06S-R27E
AMC 326278	SOB 214	458	916			SEC34-T06S-R27E
AMC 326279	SOB 215	458	917			SEC26-T06S-R27E
AMC 326280	SOB 216	458	918			SEC26-T06S-R27E
AMC 326281	SOB 217	458	919			SEC26-T06S-R27E
AMC 326282	SOB 218	458	920			SEC26-T06S-R27E

Date: 5/23/2018

Page 24

RECEIVED  
BLM AZ STATE OFFICE  
JUN 25 11:00 AM  
PHOENIX, ARIZONA

## EXHIBIT A

County: Graham

State: AZ

<u>BLM Serial #</u>	<u>Claim Name</u>	<u>Original Recording</u>		<u>Amended Recording</u>		<u>Location</u>
		<u>Recording #</u>	<u>Page #</u>	<u>Recording #</u>	<u>Page #</u>	
AMC 326843	M19	463	593			SEC14-T06S-R27E
AMC 326844	M20	463	595			SEC14-T06S-R27E
AMC 326845	M21	463	597			SEC14-T06S-R27E
AMC 326846	M22	463	599			SEC14-T06S-R27E
AMC 326847	M23	463	601			SEC14-T06S-R27E
AMC 326848	M24	463	603			SEC14-T06S-R27E
AMC 326849	M25	463	605			SEC14-T06S-R27E
AMC 326850	M26	463	607			SEC14-T06S-R27E
AMC 326851	M27	463	609			SEC14-T06S-R27E
AMC 326852	M28	463	611			SEC14-T06S-R27E
AMC 326853	M29	463	613			SEC14-T06S-R27E
AMC 326854	M30	463	615			SEC14-T06S-R27E
AMC 326855	M31	463	617			SEC14-T06S-R27E
AMC 326856	M55	463	629			SEC14-T06S-R27E
AMC 326857	M32	463	619			SEC14-T06S-R27E
AMC 326858	M33	463	621			SEC14-T06S-R27E
AMC 326859	M34	463	623			SEC14-T06S-R27E
AMC 326860	M35	463	625			SEC14-T06S-R27E
AMC 326861	M36	463	627			SEC14-T06S-R27E
AMC 326862	M57	463	631			SEC14-T06S-R27E
AMC 326863	M59	463	633			SEC14-T06S-R27E
AMC 326864	M61	463	635			SEC14-T06S-R27E
AMC 326865	M63	463	637			SEC14-T06S-R27E
AMC 326866	M65	463	639			SEC14-T06S-R27E
AMC 326867	M67	463	641			SEC14-T06S-R27E
AMC 326868	M69	463	643			SEC14-T06S-R27E
AMC 326869	M71	463	645			SEC14-T06S-R27E
AMC 326870	M145	463	647			SEC22-T06S-R27E
AMC 326871	M146	463	649			SEC22-T06S-R27E
AMC 326872	M147	463	651			SEC22-T06S-R27E
AMC 326873	M148	463	653			SEC22-T06S-R27E
AMC 326874	M149	463	655			SEC22-T06S-R27E
AMC 326875	M150	463	657			SEC22-T06S-R27E
AMC 326876	M151	463	659			SEC22-T06S-R27E
AMC 326877	M152	463	661			SEC22-T06S-R27E
AMC 326878	M153	463	663			SEC22-T06S-R27E
AMC 326879	M154	463	665			SEC22-T06S-R27E
AMC 326880	M155	463	667			SEC22-T06S-R27E

Date: 5/23/2018

Page 25

RECEIVED  
BLM AZ STATE OFFICE  
2018 JUN 25 P 1:00  
PHOENIX, ARIZONA

## EXHIBIT A

County: Graham

State: AZ

<u>BLM Serial #</u>	<u>Claim Name</u>	<u>Original Recording</u>		<u>Amended Recording</u>		<u>Location</u>
		<u>Recording #</u>	<u>Page #</u>	<u>Recording #</u>	<u>Page #</u>	
AMC 326881	M156	463	669			SEC22-T06S-R27E
AMC 326882	M157	463	671			SEC22-T06S-R27E
AMC 326883	M158	463	673			SEC22-T06S-R27E
AMC 326884	M159	463	675			SEC22-T06S-R27E
AMC 326885	M160	463	677			SEC22-T06S-R27E
AMC 326886	M161	463	679			SEC22-T06S-R27E
AMC 326887	M162	463	681			SEC22-T06S-R27E
AMC 326888	M163	463	683			SEC23-T06S-R27E
AMC 326889	M164	463	685			SEC23-T06S-R27E
AMC 326890	M165	463	687			SEC23-T06S-R27E
AMC 326891	M166	463	689			SEC23-T06S-R27E
AMC 326892	M167	463	691			SEC23-T06S-R27E
AMC 326893	M168	463	693			SEC23-T06S-R27E
AMC 326894	M169	463	695			SEC23-T06S-R27E
AMC 326895	M170	463	697			SEC23-T06S-R27E
AMC 326896	M171	463	699			SEC23-T06S-R27E
AMC 326897	M172	463	701			SEC23-T06S-R27E
AMC 326898	M173	463	703			SEC23-T06S-R27E
AMC 326899	M174	463	705			SEC23-T06S-R27E
AMC 326900	M175	463	707			SEC23-T06S-R27E
AMC 326901	M176	463	709			SEC23-T06S-R27E
AMC 326902	M177	463	711			SEC23-T06S-R27E
AMC 326903	M178	463	713			SEC23-T06S-R27E
AMC 326904	M188	463	715			SEC22-T06S-R27E
AMC 326905	M189	463	717			SEC22-T06S-R27E
AMC 326906	M190	463	719			SEC22-T06S-R27E
AMC 326907	M191	463	721			SEC22-T06S-R27E
AMC 326908	M192	463	723			SEC22-T06S-R27E
AMC 326909	M193	463	725			SEC22-T06S-R27E
AMC 326910	M194	463	727			SEC22-T06S-R27E
AMC 326911	M195	463	729			SEC22-T06S-R27E
AMC 326912	M196	463	731			SEC22-T06S-R27E
AMC 326913	M197	463	733			SEC23-T06S-R27E
AMC 326914	M199	463	735			SEC22-T06S-R27E
AMC 326915	M200	463	737			SEC22-T06S-R27E
AMC 326916	M201	463	739			SEC22-T06S-R27E
AMC 326917	M202	463	741			SEC22-T06S-R27E
AMC 326918	M203	463	743			SEC22-T06S-R27E

Date: 5/23/2018

Page 26

RECEIVED  
BLM AZ STATE OFFICE  
2018 JUN 25 P 1:00  
PHOENIX, ARIZONA

## EXHIBIT A

County: Graham

State: AZ

<u>BLM Serial #</u>	<u>Claim Name</u>	<u>Original Recording</u>		<u>Amended Recording</u>		<u>Location</u>
		<u>Recording #</u>	<u>Page #</u>	<u>Recording #</u>	<u>Page #</u>	
AMC 326919	M204	463	745			SEC22-T06S-R27E
AMC 326920	M205	463	747			SEC22-T06S-R27E
AMC 326921	M206	463	749			SEC22-T06S-R27E
AMC 329068	MG 5	471	483			SEC20-T05S-R26E
AMC 329077	MG 24	471	501			SEC20-T05S-R26E
AMC 329078	MG 25	471	503			SEC20-T05S-R26E
AMC 329087	MG 83	471	521			SEC19-T05S-R26E
AMC 329088	MG 84	471	523			SEC19-T05S-R26E
AMC 329089	MG 131	471	525			SEC19-T05S-R26E
AMC 329090	MG 133	471	527			SEC19-T05S-R26E
AMC 329091	MG 135	471	529			SEC19-T05S-R26E
AMC 329092	MG 137	471	531			SEC19-T05S-R26E
AMC 329093	MG 139	471	533			SEC19-T05S-R26E
AMC 329113	Joy 179	471	573			SEC10-T06S-R26E
AMC 329115	Joy 181	471	577			SEC10-T06S-R26E
AMC 329123	Joy 189	471	593			SEC10-T06S-R26E
AMC 329124	Joy 190	471	595			SEC11-T06S-R26E
AMC 329125	Joy 191	471	597			SEC11-T06S-R26E
AMC 329126	Joy 192	471	599			SEC11-T06S-R26E
AMC 329127	Joy 193	471	601			SEC11-T06S-R26E
AMC 329128	Joy 194	471	603			SEC11-T06S-R26E
AMC 329129	Joy 195	471	605			SEC11-T06S-R26E
AMC 329130	Joy 196	471	607			SEC11-T06S-R26E
AMC 329144	Joy 210A	471	635	481	919	SEC02-T06S-R26E
AMC 329145	Joy 212A	471	637	481	923	SEC02-T06S-R26E
AMC 330969	Joy 214	478	215			SEC02-T06S-R26E
AMC 330971	Joy 216	478	219			SEC02-T06S-R26E
AMC 330973	Joy 218	478	223			SEC02-T06S-R26E
AMC 331745	Joy 303	483	801			SEC14-T06S-R26E
AMC 331747	Joy 305	483	805			SEC14-T06S-R26E
AMC 331749	Joy 307	483	809			SEC14-T06S-R26E
AMC 331751	Joy 309	483	813			SEC14-T06S-R26E
AMC 331752	Joy 310	483	815			SEC14-T06S-R26E
AMC 331753	Joy 312	483	817			SEC14-T06S-R26E
AMC 333390	M207	488	141			SEC21-T06S-R27E
AMC 333391	M208	488	143			SEC21-T06S-R27E
AMC 333392	M209	488	145			SEC21-T06S-R27E
AMC 333393	M210	488	147			SEC21-T06S-R27E

Date: 5/23/2018

Page 27

RECEIVED  
BLM AZ STATE OFFICE  
2018 JUN 25 P 1:00  
PHOENIX, ARIZONA

## EXHIBIT A

County: Graham

State: AZ

BLM Serial #	Claim Name	Original Recording		Amended Recording		Location
		Recording #	Page #	Recording #	Page #	
AMC 333394	M211	488	149			SEC21-T06S-R27E
AMC 333395	M212	488	151			SEC21-T06S-R27E
AMC 333396	M213	488	153			SEC21-T06S-R27E
AMC 333397	M214	488	155			SEC21-T06S-R27E
AMC 333398	M215	488	157			SEC21-T06S-R27E
AMC 333399	M216	488	159			SEC21-T06S-R27E
AMC 333400	M217	488	161			SEC21-T06S-R27E
AMC 333401	M218	488	163			SEC21-T06S-R27E
AMC 333402	M219	488	165			SEC21-T06S-R27E
AMC 333403	M220	488	167			SEC21-T06S-R27E
AMC 333404	M221	488	169			SEC21-T06S-R27E
AMC 333405	M222	488	171			SEC21-T06S-R27E
AMC 333406	M223	488	173			SEC21-T06S-R27E
AMC 333407	M224	488	175			SEC21-T06S-R27E
AMC 333408	M225	488	177			SEC21-T06S-R27E
AMC 333409	M226	488	179			SEC21-T06S-R27E
AMC 333410	M227	488	181			SEC21-T06S-R27E
AMC 333411	M228	488	183			SEC21-T06S-R27E
AMC 333412	M229	488	185			SEC21-T06S-R27E
AMC 333413	M230	488	187			SEC21-T06S-R27E
AMC 333414	M231	488	189			SEC21-T06S-R27E
AMC 333415	M232	488	191			SEC21-T06S-R27E
AMC 333416	M233	488	193			SEC21-T06S-R27E
AMC 333417	M234	488	195			SEC21-T06S-R27E
AMC 333418	M235	488	197			SEC21-T06S-R27E
AMC 333419	M236	488	199			SEC16-T06S-R27E
AMC 333420	M237	488	201			SEC16-T06S-R27E
AMC 333421	M238	488	203			SEC16-T06S-R27E
AMC 334772	CHE 1	492	843			SEC23-T05S-R25E
AMC 334773	CHE 2	492	845			SEC23-T05S-R25E
AMC 334774	CHE 3	492	847			SEC23-T05S-R25E
AMC 334775	CHE 4	492	849			SEC23-T05S-R25E
AMC 334776	CHE 5	492	851			SEC23-T05S-R25E
AMC 334777	CHE 6	492	853			SEC23-T05S-R25E
AMC 334778	CHE 7	492	855			SEC23-T05S-R25E
AMC 334779	CHE 8	492	857			SEC23-T05S-R25E
AMC 334780	CHE 9	492	859			SEC23-T05S-R25E
AMC 334781	CHE 10	492	861			SEC23-T05S-R25E

Date: 5/23/2018

RECEIVED  
BLM AZ STATE OFFICE  
2018 JUN 25 P 1:00  
PHOENIX, ARIZONA

## EXHIBIT A

County: Graham

State: AZ

<u>BLM Serial #</u>	<u>Claim Name</u>	<u>Original Recording</u>		<u>Amended Recording</u>		<u>Location</u>
		<u>Recording #</u>	<u>Page #</u>	<u>Recording #</u>	<u>Page #</u>	
AMC 334782	CHE 11	492	863			SEC26-T05S-R25E
AMC 334783	CHE 12	492	865			SEC26-T05S-R25E
AMC 334784	CHE 13	492	867			SEC26-T05S-R25E
AMC 334785	CHE 14	492	869			SEC26-T05S-R25E
AMC 334786	CHE 15	492	871			SEC26-T05S-R25E
AMC 334787	CHE 16	492	873			SEC26-T05S-R25E
AMC 334788	CHE 17	492	875			SEC26-T05S-R25E
AMC 334789	CHE 18	492	877			SEC26-T05S-R25E
AMC 334790	CHE 19	492	879			SEC26-T05S-R25E
AMC 334791	CHE 20	492	881			SEC26-T05S-R25E
AMC 334792	CHE 21	492	883			SEC26-T05S-R25E
AMC 334793	CHE 22	492	885			SEC26-T05S-R25E
AMC 334794	CHE 23	492	887			SEC26-T05S-R25E
AMC 334795	CHE 24	492	889			SEC26-T05S-R25E
AMC 334796	CHE 25	492	891			SEC26-T05S-R25E
AMC 334797	CHE 26	492	893			SEC26-T05S-R25E
AMC 334798	CHE 27	492	895			SEC26-T05S-R25E
AMC 334799	CHE 28	492	897			SEC26-T05S-R25E
AMC 334800	CHE 29	492	899			SEC23-T05S-R25E
AMC 334801	CHE 30	492	901			SEC23-T05S-R25E
AMC 334802	CHE 31	492	903			SEC23-T05S-R25E
AMC 334803	CHE 32	492	905			SEC23-T05S-R25E
AMC 334804	CHE 33	492	907			SEC23-T05S-R25E
AMC 334805	CHE 34	492	909			SEC23-T05S-R25E
AMC 334806	CHE 35	492	911			SEC23-T05S-R25E
AMC 334807	CHE 36	492	913			SEC23-T05S-R25E
AMC 334808	CHE 37	492	915			SEC23-T05S-R25E
AMC 334809	CHE 38	492	917			SEC23-T05S-R25E
AMC 334810	CHE 39	492	919			SEC26-T05S-R25E
AMC 334811	CHE 40	492	921			SEC26-T05S-R25E
AMC 334812	CHE 41	492	923			SEC26-T05S-R25E
AMC 334813	CHE 42	492	925			SEC26-T05S-R25E
AMC 334814	CHE 43	492	927			SEC26-T05S-R25E
AMC 334815	CHE 44	492	929			SEC26-T05S-R25E
AMC 334816	CHE 45	492	931			SEC26-T05S-R25E
AMC 334817	CHE 46	492	933			SEC26-T05S-R25E
AMC 334818	CHE 47	492	935			SEC26-T05S-R25E
AMC 334819	CHE 48	492	937			SEC26-T05S-R25E

Date: 5/23/2018

Page 29

RECEIVED  
BLM AZ STATE OFFICE  
PHOENIX, ARIZONA  
2018 JUN 25 P 1:08



## EXHIBIT A

County: Graham

State: AZ

BLM Serial #	Claim Name	Original Recording		Amended Recording		Location
		Recording #	Page #	Recording #	Page #	
AMC 334820	CHE 49	492	939			SEC26-T05S-R25E
AMC 334821	CHE 50	492	941			SEC26-T05S-R25E
AMC 334822	CHE 51	492	943			SEC26-T05S-R25E
AMC 334823	CHE 52	492	945			SEC26-T05S-R25E
AMC 334824	CHE 53	492	947			SEC26-T05S-R25E
AMC 334825	CHE 54	492	949			SEC26-T05S-R25E
AMC 334826	CHE 55	492	951			SEC26-T05S-R25E
AMC 334827	CHE 56	492	953			SEC26-T05S-R25E
AMC 340515	BH 21	510	117			SEC24-T05S-R26E
AMC 340539	Cliff 1R	510	1			SEC22-T05S-R26E
AMC 340540	Cliff 2R	510	3			SEC22-T05S-R26E
AMC 340541	Cliff 3R	510	5			SEC22-T05S-R26E
AMC 340542	Cliff 4R	510	7			SEC22-T05S-R26E
AMC 340543	Cliff 6R	510	9			SEC22-T05S-R26E
AMC 340544	Cliff 8R	510	11			SEC22-T05S-R26E
AMC 340545	Cliff 23R	510	13			SEC26-T05S-R26E
AMC 340546	Cliff 24R	510	15			SEC26-T05S-R26E
AMC 340547	Cliff 25R	510	17			SEC23-T05S-R26E
AMC 340548	Cliff 26R	510	19			SEC23-T05S-R26E
AMC 340549	Cliff 27R	510	21			SEC23-T05S-R26E
AMC 340550	Cliff 28R	510	23			SEC23-T05S-R26E
AMC 340551	Cliff 29R	510	25			SEC23-T05S-R26E
AMC 340552	Cliff 30R	510	27			SEC23-T05S-R26E
AMC 340553	Cliff 31R	510	29			SEC23-T05S-R26E
AMC 340554	Cliff 32R	510	31			SEC23-T05S-R26E
AMC 340558	Cliff 41R Amended	510	39	532	479	SEC23-T05S-R26E
AMC 340559	Cliff 42R Amended	510	41	532	751	SEC23-T05S-R26E
AMC 340560	Cliff 43R Amended	510	43	532	753	SEC23-T05S-R26E
AMC 340561	Cliff 44R Amended	510	45	532	755	SEC23-T05S-R26E
AMC 340562	Cliff 45	510	47			SEC23-T05S-R26E
AMC 340563	Cliff 46	510	49			SEC23-T05S-R26E
AMC 340564	Cliff 59	510	51			SEC23-T05S-R26E
AMC 340565	Cliff 60	510	53			SEC23-T05S-R26E
AMC 340566	Cliff 61	510	55			SEC23-T05S-R26E
AMC 340567	Cliff 62	510	57			SEC23-T05S-R26E
AMC 340568	Cliff 63	510	59			SEC23-T05S-R26E
AMC 340569	Cliff 64	510	61			SEC14-T05S-R26E
AMC 340570	Cliff 65	510	63			SEC14-T05S-R26E

Date: 5/23/2018

Page 30

RECEIVED  
BLM AZ STATE OFFICE  
2018 JUN 25 P 1:00  
PHOENIX, ARIZONA

## EXHIBIT A

County: Graham

State: AZ

<u>BLM Serial #</u>	<u>Claim Name</u>	<u>Original Recording</u>		<u>Amended Recording</u>		<u>Location</u>
		<u>Recording #</u>	<u>Page #</u>	<u>Recording #</u>	<u>Page #</u>	
AMC 340956	SG 1	513	27			SEC20-T06S-R27E
AMC 340957	SG 2	513	29			SEC28-T06S-R27E
AMC 340958	SG 3	513	31			SEC29-T06S-R27E
AMC 340959	SG 4	513	33			SEC29-T06S-R27E
AMC 340960	SG 5	513	35			SEC29-T06S-R27E
AMC 340961	SG 6	513	37			SEC33-T06S-R27E
AMC 340962	SG 7	513	39			SEC33-T06S-R27E
AMC 340963	SG 8	513	41			SEC33-T06S-R27E
AMC 340964	SG 9	513	43			SEC04-T07S-R27E
AMC 340965	SG 10	513	45			SEC04-T07S-R27E
AMC 340966	SG 11	513	47			SEC04-T07S-R27E
AMC 340967	SG 12 Amended	513	49	525	947	SEC04-T07S-R27E
AMC 340968	SG 13	513	51			SEC04-T07S-R27E
AMC 340969	SG 14	513	53			SEC04-T07S-R27E
AMC 340970	SG 15	513	55			SEC33-T06S-R27E
AMC 340971	SG 16	513	57			SEC33-T06S-R27E
AMC 340972	SG 17	513	59			SEC33-T06S-R27E
AMC 340973	SG 18	513	61			SEC33-T06S-R27E
AMC 340974	SG 19	513	63			SEC33-T06S-R27E
AMC 340975	SG 20	513	65			SEC33-T06S-R27E
AMC 340976	SG 21	513	67			SEC34-T06S-R27E
AMC 340977	SG 22	513	69			SEC34-T06S-R27E
AMC 340978	SG 23	513	71			SEC27-T06S-R27E
AMC 340979	SG 24	513	73			SEC34-T06S-R27E
AMC 340980	SG 25	513	75			SEC34-T06S-R27E
AMC 340981	SG 26	513	77			SEC27-T06S-R27E
AMC 340982	SG 27	513	79			SEC27-T06S-R27E
AMC 340983	SG 28	513	81			SEC26-T06S-R27E
AMC 340984	SG 29	513	83			SEC27-T06S-R27E
AMC 340985	SG 30	513	85			SEC27-T06S-R27E
AMC 340986	SG 31	513	87			SEC26-T06S-R27E
AMC 340987	SG 32	513	89			SEC27-T06S-R27E
AMC 340988	SG 33	513	91			SEC27-T06S-R27E
AMC 340989	SG 34	513	93			SEC23-T06S-R27E
AMC 340990	SG 35	513	95			SEC23-T06S-R27E
AMC 340991	SG 36	513	97			SEC23-T06S-R27E
AMC 340992	SG 37	513	99			SEC23-T06S-R27E
AMC 340993	SG 38	513	101			SEC28-T06S-R27E

Date: 5/23/2018

Page 31

RECEIVED  
BLM AZ STATE OFFICE  
2816 JUN 25 P 1:00  
PHOENIX, ARIZONA

## EXHIBIT A

County: Graham

State: AZ

BLM Serial #	Claim Name	Original Recording		Amended Recording		Location
		Recording #	Page #	Recording #	Page #	
AMC 340994	SG 39	513	103			SEC24-T06S-R27E
AMC 340995	SG 40	513	105			SEC25-T06S-R27E
AMC 340996	SG 41	513	107			SEC27-T06S-R27E
AMC 340997	SG 42	513	109			SEC28-T06S-R27E
AMC 340998	SG 43	513	111			SEC28-T06S-R27E
AMC 340999	SG 44	513	113			SEC23-T06S-R27E
AMC 341000	SG 45	513	115			SEC23-T06S-R27E
AMC 341001	SG 46	513	117			SEC25-T06S-R27E
AMC 341002	SZ 1	513	119			SEC29-T06S-R27E
AMC 341003	SZ 2	513	121			SEC29-T06S-R27E
AMC 341004	SZ 3	513	123			SEC29-T06S-R27E
AMC 341005	SZ 4	513	125			SEC29-T06S-R27E
AMC 341006	SZ 5	513	127			SEC29-T06S-R27E
AMC 341007	SZ 6	513	129			SEC29-T06S-R27E
AMC 341008	SZ 7	513	131			SEC29-T06S-R27E
AMC 341009	SZ 8	513	133			SEC29-T06S-R27E
AMC 341010	SZ 9	513	135			SEC29-T06S-R27E
AMC 341011	SZ 10	513	137			SEC29-T06S-R27E
AMC 341012	SZ 11	513	139			SEC29-T06S-R27E
AMC 341013	SZ 12	513	141			SEC29-T06S-R27E
AMC 341014	SZ 13	513	143			SEC29-T06S-R27E
AMC 341015	SZ 14	513	145			SEC20-T06S-R27E
AMC 341016	SZ 15	513	147			SEC20-T06S-R27E
AMC 341017	SZ 16	513	149			SEC20-T06S-R27E
AMC 341018	SZ 17	513	151			SEC20-T06S-R27E
AMC 341019	SZ 18	513	153			SEC20-T06S-R27E
AMC 341020	SZ 19	513	155			SEC20-T06S-R27E
AMC 341021	SZ 20	513	157			SEC20-T06S-R27E
AMC 341022	SZ 21	513	159			SEC20-T06S-R27E
AMC 341023	SZ 22	513	161			SEC20-T06S-R27E
AMC 341024	SZ 23	513	163			SEC20-T06S-R27E
AMC 341025	SZ 24	513	165			SEC20-T06S-R27E
AMC 341026	SZ 25	513	167			SEC20-T06S-R27E
AMC 341652	BH 4B	514	787			SEC26-T05S-R26E
AMC 341653	BH 6B	514	789			SEC26-T05S-R26E
AMC 341654	BH 8B	514	791			SEC26-T05S-R26E
AMC 341655	BH 10B	514	793			SEC25-T05S-R26E
AMC 341656	BH 12B	514	795			SEC25-T05S-R26E

Date: 5/23/2018

RECEIVED  
BLM AZ STATE OFFICE  
2018 JUN 25 P 1:01  
PHOENIX, ARIZONA

## EXHIBIT A

County: Graham

State: AZ

<u>BLM Serial #</u>	<u>Claim Name</u>	<u>Original Recording</u>		<u>Amended Recording</u>		<u>Location</u>
		<u>Recording #</u>	<u>Page #</u>	<u>Recording #</u>	<u>Page #</u>	
AMC 341657	BH 14B	514	797			SEC25-T05S-R26E
AMC 341658	BH 16B	514	799			SEC25-T05S-R26E
AMC 341659	BH 18B	514	801			SEC25-T05S-R26E
AMC 341660	BH 20B	514	803			SEC25-T05S-R26E
AMC 341661	BH 22B	514	805			SEC24-T05S-R26E
AMC 341662	BH 25B	514	807			SEC25-T05S-R26E
AMC 341663	BH 26B	514	809			SEC25-T05S-R26E
AMC 341664	BH 27B	514	811			SEC25-T05S-R26E
AMC 341665	BH 28B	514	813			SEC25-T05S-R26E
AMC 341666	BH 29B	514	815			SEC25-T05S-R26E
AMC 341667	BH 30B	514	817			SEC25-T05S-R26E
AMC 341668	BH 31B	514	819			SEC25-T05S-R26E
AMC 341669	BH 32B	514	821			SEC25-T05S-R26E
AMC 341670	BH 33B	514	823			SEC25-T05S-R26E
AMC 341671	BH 34B	514	825			SEC25-T05S-R26E
AMC 341672	BH 35B	514	827			SEC25-T05S-R26E
AMC 341673	BH 36B	514	829			SEC25-T05S-R26E
AMC 341674	BH 37B	514	831			SEC25-T05S-R26E
AMC 341675	BH 38B	514	833			SEC25-T05S-R26E
AMC 341676	BH 39B	514	835			SEC25-T05S-R26E
AMC 341677	BH 40B	514	837			SEC25-T05S-R26E
AMC 341678	BH 41B	514	839			SEC25-T05S-R26E
AMC 341679	BH 42B	514	841			SEC25-T05S-R26E
AMC 341680	BH 43B	514	843			SEC24-T05S-R26E
AMC 341681	BH 44B	514	845			SEC24-T05S-R26E
AMC 344109	SL 1	519	61			SEC26-T06S-R27E
AMC 344110	SL 2	519	63			SEC26-T06S-R27E
AMC 344111	SL 3	519	65			SEC26-T06S-R27E
AMC 344112	SL 4	519	67			SEC26-T06S-R27E
AMC 344113	SL 5	519	69			SEC26-T06S-R27E
AMC 344114	SL 6	519	71			SEC26-T06S-R27E
AMC 344115	SL 7	519	73			SEC25-T06S-R27E
AMC 344116	SG 47	519	75			SEC26-T06S-R27E
AMC 344117	SG 48	519	77			SEC26-T06S-R27E
AMC 344118	SG 49	519	79			SEC26-T06S-R27E
AMC 344119	SG 50	519	81			SEC23-T06S-R27E
AMC 344120	SG 51	519	83			SEC24-T06S-R27E
AMC 344121	SG 52	519	85			SEC24-T06S-R27E

Date: 5/23/2018

Page 33

RECEIVED  
 BLM AZ STATE OFFICE  
 PHOENIX, ARIZONA  
 2018 JUN 25 P 1:01

## EXHIBIT A

County: Graham

State: AZ

<u>BLM Serial #</u>	<u>Claim Name</u>	<u>Original Recording</u>		<u>Amended Recording</u>		<u>Location</u>
		<u>Recording #</u>	<u>Page #</u>	<u>Recording #</u>	<u>Page #</u>	
AMC 344122 —	SG 53		519	419		SEC27-T06S-R27E
AMC 430691 7	ROCKSTAR 001	2015-1345				SEC01-T06S-R27E
AMC 430692	ROCKSTAR 002	2015-1346				SEC01-T06S-R27E
AMC 430693	ROCKSTAR 003	2015-1347				SEC01-T06S-R27E
AMC 430694	ROCKSTAR 004	2015-1348				SEC01-T06S-R27E
AMC 430695	ROCKSTAR 005	2015-1349				SEC01-T06S-R27E
AMC 430696	ROCKSTAR 006	2015-1350				SEC01-T06S-R27E
AMC 430697	ROCKSTAR 007	2015-1351				SEC01-T06S-R27E
AMC 430698	ROCKSTAR 008	2015-1352				SEC01-T06S-R27E
AMC 430699	ROCKSTAR 009	2015-1353				SEC01-T06S-R27E
AMC 430700	ROCKSTAR 010	2015-1354				SEC01-T06S-R27E
AMC 430701	ROCKSTAR 011	2015-1355				SEC01-T06S-R27E
AMC 430702	ROCKSTAR 012	2015-1356				SEC01-T06S-R27E
AMC 430703	ROCKSTAR 013	2015-1357				SEC01-T06S-R27E
AMC 430704	ROCKSTAR 014	2015-1358				SEC01-T06S-R27E
AMC 430705	ROCKSTAR 015	2015-1359				SEC01-T06S-R27E
AMC 430706	ROCKSTAR 016	2015-1360				SEC01-T06S-R27E
AMC 430707	ROCKSTAR 017	2015-1361				SEC01-T06S-R27E
AMC 430708	ROCKSTAR 018	2015-1362				SEC01-T06S-R27E
AMC 430709	ROCKSTAR 019	2015-1363				SEC01-T06S-R27E
AMC 430710	ROCKSTAR 020	2015-1364				SEC01-T06S-R27E
AMC 430711	ROCKSTAR 021	2015-1365				SEC01-T06S-R27E
AMC 430712	ROCKSTAR 022	2015-1366				SEC01-T06S-R27E
AMC 430713	ROCKSTAR 023	2015-1367				SEC01-T06S-R27E
AMC 430714	ROCKSTAR 024	2015-1368				SEC01-T06S-R27E
AMC 430715	ROCKSTAR 025	2015-1369				SEC01-T06S-R27E
AMC 430716	ROCKSTAR 026	2015-1370				SEC01-T06S-R27E
AMC 430717	ROCKSTAR 027	2015-1371				SEC01-T06S-R27E
AMC 430718	ROCKSTAR 028	2015-1372				SEC01-T06S-R27E
AMC 430719	ROCKSTAR 029	2015-1373				SEC01-T06S-R27E
AMC 430720	ROCKSTAR 030	2015-1374				SEC01-T06S-R27E
AMC 430721	ROCKSTAR 031	2015-1375				SEC01-T06S-R27E
AMC 430722	ROCKSTAR 032	2015-1376				SEC01-T06S-R27E
AMC 430723	ROCKSTAR 033	2015-1377				SEC01-T06S-R27E
AMC 430724	ROCKSTAR 034	2015-1378				SEC01-T06S-R27E
AMC 430725	ROCKSTAR 035	2015-1379				SEC01-T06S-R27E
AMC 430726	ROCKSTAR 036	2015-1380				SEC01-T06S-R27E
AMC 430751 —	ROCKSTAR 037	2015-1381				SEC02-T06S-R27E

Date: 5/23/2018

PHOENIX, ARIZONA

2018 JUN 25 P 1:01

RECEIVED  
BLM AZ STATE OFFICE

**EXHIBIT A**

County: Graham

State: AZ

<u>BLM Serial #</u>	<u>Claim Name</u>	<u>Original Recording</u>		<u>Amended Recording</u>		<u>Location</u>
		<u>Recording #</u>	<u>Page #</u>	<u>Recording #</u>	<u>Page #</u>	
AMC 430752	ROCKSTAR 038	2015-1382				SEC02-T06S-R27E
AMC 430753	ROCKSTAR 039	2015-1383				SEC02-T06S-R27E
AMC 430754	ROCKSTAR 040	2015-1384				SEC02-T06S-R27E
AMC 430755	ROCKSTAR 041	2015-1385				SEC02-T06S-R27E
AMC 430756	ROCKSTAR 042	2015-1386				SEC02-T06S-R27E
AMC 430757	ROCKSTAR 043	2015-1387				SEC02-T06S-R27E
AMC 430758	ROCKSTAR 044	2015-1388				SEC02-T06S-R27E
AMC 430759	ROCKSTAR 045	2015-1389				SEC02-T06S-R27E
AMC 430760	ROCKSTAR 046	2015-1390				SEC02-T06S-R27E
AMC 430761	ROCKSTAR 047	2015-1391				SEC02-T06S-R27E
AMC 430762	ROCKSTAR 048	2015-1392				SEC02-T06S-R27E
AMC 430763	ROCKSTAR 049	2015-1393				SEC02-T06S-R27E
AMC 430764	ROCKSTAR 050	2015-1394				SEC02-T06S-R27E
AMC 430765	ROCKSTAR 051	2015-1395				SEC02-T06S-R27E
AMC 430766	ROCKSTAR 052	2015-1396				SEC02-T06S-R27E
AMC 430767	ROCKSTAR 053	2015-1397				SEC02-T06S-R27E
AMC 430768	ROCKSTAR 054	2015-1398				SEC02-T06S-R27E
AMC 430769	ROCKSTAR 055	2015-1399				SEC02-T06S-R27E
AMC 430770	ROCKSTAR 056	2015-1400				SEC02-T06S-R27E
AMC 430771	ROCKSTAR 057	2015-1401				SEC02-T06S-R27E
AMC 430772	ROCKSTAR 058	2015-1402				SEC02-T06S-R27E
AMC 430773	ROCKSTAR 059	2015-1403				SEC02-T06S-R27E
AMC 430774	ROCKSTAR 060	2015-1404				SEC02-T06S-R27E
AMC 430775	ROCKSTAR 061	2015-1405				SEC02-T06S-R27E
AMC 430776	ROCKSTAR 062	2015-1406				SEC02-T06S-R27E
AMC 430777	ROCKSTAR 063	2015-1407				SEC02-T06S-R27E
AMC 430778	ROCKSTAR 064	2015-1408				SEC02-T06S-R27E
AMC 430779	ROCKSTAR 065	2015-1409				SEC02-T06S-R27E
AMC 430780	ROCKSTAR 066	2015-1410				SEC02-T06S-R27E
AMC 430781	ROCKSTAR 067	2015-1411				SEC02-T06S-R27E
AMC 430782	ROCKSTAR 068	2015-1412				SEC02-T06S-R27E
AMC 430783	ROCKSTAR 069	2015-1413				SEC02-T06S-R27E
AMC 430784	ROCKSTAR 070	2015-1414				SEC02-T06S-R27E
AMC 430785	ROCKSTAR 071	2015-1415				SEC02-T06S-R27E
AMC 430786	ROCKSTAR 072	2015-1416				SEC02-T06S-R27E
AMC 430787	ROCKSTAR 073	2015-1417				SEC03-T06S-R27E
AMC 430788	ROCKSTAR 074	2015-1418				SEC03-T06S-R27E
AMC 430789	ROCKSTAR 075	2015-1419				SEC03-T06S-R27E

Date: 5/23/2018

RECEIVED  
BLM AZ STATE OFFICE  
2018 JUN 25 P 1:01  
PHOENIX, ARIZONA

## EXHIBIT A

County: Graham

State: AZ

<u>BLM Serial #</u>	<u>Claim Name</u>	<u>Original Recording</u>		<u>Amended Recording</u>		<u>Location</u>
		<u>Recording #</u>	<u>Page #</u>	<u>Recording #</u>	<u>Page #</u>	
AMC 430790	ROCKSTAR 076	2015-1420				SEC03-T06S-R27E
AMC 430791	ROCKSTAR 077	2015-1421				SEC03-T06S-R27E
AMC 430792	ROCKSTAR 078	2015-1422				SEC03-T06S-R27E
AMC 430793	ROCKSTAR 079	2015-1423				SEC03-T06S-R27E
AMC 430794	ROCKSTAR 080	2015-1424				SEC03-T06S-R27E
AMC 430795	ROCKSTAR 081	2015-1425				SEC03-T06S-R27E
AMC 430796	ROCKSTAR 082	2015-1426				SEC03-T06S-R27E
AMC 430797	ROCKSTAR 083	2015-1427				SEC03-T06S-R27E
AMC 430798	ROCKSTAR 084	2015-1428				SEC03-T06S-R27E
AMC 430799	ROCKSTAR 085	2015-1429				SEC03-T06S-R27E
AMC 430800	ROCKSTAR 086	2015-1430				SEC03-T06S-R27E
AMC 430801	ROCKSTAR 087	2015-1431				SEC03-T06S-R27E
AMC 430802	ROCKSTAR 088	2015-1432				SEC03-T06S-R27E
AMC 430803	ROCKSTAR 089	2015-1433				SEC03-T06S-R27E
AMC 430804	ROCKSTAR 090	2015-1434				SEC03-T06S-R27E
AMC 430805	ROCKSTAR 091	2015-1435				SEC12-T06S-R27E
AMC 430806	ROCKSTAR 092	2015-1436				SEC12-T06S-R27E
AMC 430807	ROCKSTAR 093	2015-1437				SEC12-T06S-R27E
AMC 430808	ROCKSTAR 094	2015-1438				SEC12-T06S-R27E
AMC 430809	ROCKSTAR 095	2015-1439				SEC12-T06S-R27E
AMC 430810	ROCKSTAR 096	2015-1440				SEC12-T06S-R27E
AMC 430811	ROCKSTAR 097	2015-1441				SEC12-T06S-R27E
AMC 430812	ROCKSTAR 098	2015-1442				SEC12-T06S-R27E
AMC 430813	ROCKSTAR 099	2015-1443				SEC12-T06S-R27E
AMC 430814	ROCKSTAR 100	2015-1444				SEC12-T06S-R27E
AMC 430815	ROCKSTAR 101	2015-1445				SEC12-T06S-R27E
AMC 430816	ROCKSTAR 102	2015-1446				SEC12-T06S-R27E
AMC 430817	ROCKSTAR 103	2015-1447				SEC12-T06S-R27E
AMC 430818	ROCKSTAR 104	2015-1448				SEC12-T06S-R27E
AMC 430819	ROCKSTAR 105	2015-1449				SEC12-T06S-R27E
AMC 430820	ROCKSTAR 106	2015-1450				SEC12-T06S-R27E
AMC 430821	ROCKSTAR 107	2015-1451				SEC12-T06S-R27E
AMC 430822	ROCKSTAR 108	2015-1452				SEC12-T06S-R27E
AMC 430823	ROCKSTAR 109	2015-1453				SEC12-T06S-R27E
AMC 430824	ROCKSTAR 110	2015-1454				SEC12-T06S-R27E
AMC 430825	ROCKSTAR 111	2015-1455				SEC12-T06S-R27E
AMC 430826	ROCKSTAR 112	2015-1456				SEC12-T06S-R27E
AMC 430827	ROCKSTAR 113	2015-1457				SEC12-T06S-R26E

Date: 5/23/2018

RECEIVED  
BLM AZ STATE OFFICE  
2018 JUN 25 P 1:01  
PHOENIX, ARIZONA

## EXHIBIT A

County: Graham

State: AZ

BLM Serial #	Claim Name	Original Recording		Amended Recording		Location
		Recording #	Page #	Recording #	Page #	
AMC 430828	ROCKSTAR 114	2015-1458				SEC12-T06S-R26E
AMC 430829	ROCKSTAR 115	2015-1459				SEC12-T06S-R27E
AMC 430830	ROCKSTAR 116	2015-1460				SEC12-T06S-R27E
AMC 430831	ROCKSTAR 117	2015-1461				SEC12-T06S-R27E
AMC 430832	ROCKSTAR 118	2015-1462				SEC12-T06S-R27E
AMC 430833	ROCKSTAR 119	2015-1463				SEC12-T06S-R27E
AMC 430834	ROCKSTAR 120	2015-1464				SEC12-T06S-R27E
AMC 430835	ROCKSTAR 121	2015-1465				SEC12-T06S-R27E
AMC 430836	ROCKSTAR 122	2015-1466				SEC13-T06S-R27E
AMC 430889	Red Bull-1	2015-1696				SEC27-T05S-R25E
AMC 430890	Red Bull-2	2015-1697				SEC27-T05S-R25E
AMC 430891	Red Bull-3	2015-1698				SEC27-T05S-R25E
AMC 430892	Red Bull-4	2015-1699				SEC27-T05S-R25E
AMC 430893	Red Bull-5	2015-1700				SEC27-T05S-R25E
AMC 430894	Red Bull-6	2015-1701				SEC27-T05S-R25E
AMC 430895	Red Bull-7	2015-1702				SEC27-T05S-R25E
AMC 430896	Red Bull-8	2015-1703				SEC27-T05S-R25E
AMC 430897	Red Bull-9	2015-1704				SEC27-T05S-R25E
AMC 430898	Red Bull-10	2015-1705				SEC27-T05S-R25E
AMC 430899	Red Bull-11	2015-1706				SEC27-T05S-R25E
AMC 430900	Red Bull-12	2015-1707				SEC27-T05S-R25E
AMC 430901	Red Bull-13	2015-1708				SEC27-T05S-R25E
AMC 430902	Red Bull-14	2015-1709				SEC27-T05S-R25E
AMC 430903	Red Bull-15	2015-1710				SEC27-T05S-R25E
AMC 430904	Red Bull-16	2015-1711				SEC27-T05S-R25E
AMC 430905	Red Bull-17	2015-1712				SEC27-T05S-R25E
AMC 430906	Red Bull-18	2015-1713				SEC27-T05S-R25E
AMC 430907	Red Bull-19	2015-1714				SEC27-T05S-R25E
AMC 430908	Red Bull-20	2015-1715				SEC27-T05S-R25E
AMC 430909	Red Bull-21	2015-1716				SEC27-T05S-R25E
AMC 430910	Red Bull-22	2015-1717				SEC27-T05S-R25E
AMC 430911	Red Bull-23	2015-1718				SEC27-T05S-R25E
AMC 430912	Red Bull-24	2015-1719				SEC27-T05S-R25E
AMC 430913	Red Bull-25	2015-1720				SEC27-T05S-R25E
AMC 430914	Red Bull-26	2015-1721				SEC27-T05S-R25E
AMC 430915	Red Bull-27	2015-1722				SEC27-T05S-R25E
AMC 430916	Red Bull-28	2015-1723				SEC27-T05S-R25E
AMC 430917	Red Bull-29	2015-1724				SEC27-T05S-R25E

Date: 5/23/2018

RECEIVED  
BLM AZ STATE OFFICE  
2018 JUN 25 P 1:01  
PHOENIX, ARIZONA



## EXHIBIT A

County: Graham

State: AZ

<u>BLM Serial #</u>	<u>Claim Name</u>	<u>Original Recording</u>		<u>Amended Recording</u>		<u>Location</u>
		<u>Recording #</u>	<u>Page #</u>	<u>Recording #</u>	<u>Page #</u>	
AMC 430918	Red Bull-30	2015-1725				SEC27-T05S-R25E
AMC 430919	Red Bull-31	2015-1726				SEC27-T05S-R25E
AMC 430920	Red Bull-32	2015-1727				SEC27-T05S-R25E
AMC 430921	Red Bull-33	2015-1728				SEC27-T05S-R25E
AMC 430922	Red Bull-34	2015-1729				SEC27-T05S-R25E
AMC 430923	Red Bull-35	2015-1730				SEC27-T05S-R25E
AMC 430924	Red Bull-36	2015-1731				SEC27-T05S-R25E
AMC 430925	Red Bull-37	2015-1732				SEC34-T05S-R25E
AMC 430926	Red Bull-38	2015-1733				SEC34-T05S-R25E
AMC 430927	Red Bull-39	2015-1734				SEC34-T05S-R25E
AMC 430928	Red Bull-40	2015-1735				SEC34-T05S-R25E
AMC 430929	Red Bull-41	2015-1736				SEC34-T05S-R25E
AMC 430930	Red Bull-42	2015-1737				SEC34-T05S-R25E
AMC 430931	Red Bull-43	2015-1738				SEC34-T05S-R25E
AMC 430932	Red Bull-44	2015-1739				SEC34-T05S-R25E
AMC 430933	Red Bull-45	2015-1740				SEC34-T05S-R25E
AMC 430934	Red Bull-46	2015-1741				SEC34-T05S-R25E
AMC 430935	Red Bull-47	2015-1742				SEC34-T05S-R25E
AMC 430936	Red Bull-48	2015-1743				SEC34-T05S-R25E
AMC 430937	Red Bull-49	2015-1744				SEC34-T05S-R25E
AMC 430938	Red Bull-50	2015-1745				SEC34-T05S-R25E
AMC 430939	Red Bull-51	2015-1746				SEC34-T05S-R25E
AMC 430940	Red Bull-52	2015-1747				SEC34-T05S-R25E
AMC 430941	Red Bull-53	2015-1748				SEC34-T05S-R25E
AMC 430942	Red Bull-54	2015-1749				SEC34-T05S-R25E
AMC 430943	Red Bull-55	2015-1750				SEC34-T05S-R25E
AMC 430944	Red Bull-56	2015-1751				SEC34-T05S-R25E
AMC 430945	Red Bull-57	2015-1752				SEC34-T05S-R25E
AMC 430946	Red Bull-58	2015-1753				SEC34-T05S-R25E
AMC 430947	Red Bull-59	2015-1754				SEC34-T05S-R25E
AMC 430948	Red Bull-60	2015-1755				SEC34-T05S-R25E
AMC 430949	Red Bull-61	2015-1756				SEC34-T05S-R25E
AMC 430950	Red Bull-62	2015-1757				SEC34-T05S-R25E
AMC 430951	Red Bull-63	2015-1758				SEC34-T05S-R25E
AMC 430952	Red Bull-64	2015-1759				SEC34-T05S-R25E
AMC 430953	Red Bull-65	2015-1760				SEC34-T05S-R25E
AMC 430954	Red Bull-66	2015-1761				SEC34-T05S-R25E
AMC 430955	Red Bull-67	2015-1762				SEC34-T05S-R25E

Date: 5/23/2018

PHOENIX, ARIZONA

2018 JUN 25 P 1:01

RECEIVED  
BLM AZ STATE OFFICE

## EXHIBIT A

County: Graham

State: AZ

<u>BLM Serial #</u>	<u>Claim Name</u>	<u>Original Recording</u>		<u>Amended Recording</u>		<u>Location</u>
		<u>Recording #</u>	<u>Page #</u>	<u>Recording #</u>	<u>Page #</u>	
AMC 430956	Red Bull-68	2015-1763				SEC34-T05S-R25E
AMC 430957	Red Bull-69	2015-1764				SEC34-T05S-R25E
AMC 430958	Red Bull-70	2015-1765				SEC34-T05S-R25E
AMC 430959	Red Bull-71	2015-1766				SEC34-T05S-R25E
AMC 430960	Red Bull-72	2015-1767				SEC34-T05S-R25E
AMC 430961	Red Bull-73	2015-1768				SEC33-T05S-R25E
AMC 430962	Red Bull-74	2015-1769				SEC33-T05S-R25E
AMC 430963	Red Bull-75	2015-1770				SEC33-T05S-R25E
AMC 430964	Red Bull-76	2015-1771				SEC33-T05S-R25E
AMC 430965	Red Bull-77	2015-1772				SEC33-T05S-R25E
AMC 430966	Red Bull-78	2015-1773				SEC33-T05S-R25E
AMC 430967	Red Bull-79	2015-1774				SEC33-T05S-R25E
AMC 430968	Red Bull-80	2015-1775				SEC33-T05S-R25E
AMC 430969	Red Bull-81	2015-1776				SEC33-T05S-R25E
AMC 430970	Red Bull-82	2015-1777				SEC33-T05S-R25E
AMC 430971	Red Bull-83	2015-1778				SEC33-T05S-R25E
AMC 430972	Red Bull-84	2015-1779				SEC33-T05S-R25E
AMC 430973	Red Bull-85	2015-1780				SEC33-T05S-R25E
AMC 430974	Red Bull-86	2015-1781				SEC33-T05S-R25E
AMC 430975	Red Bull-87	2015-1782				SEC33-T05S-R25E
AMC 430976	Red Bull-88	2015-1783				SEC33-T05S-R25E
AMC 430977	Red Bull-89	2015-1784				SEC33-T05S-R25E
AMC 430978	Red Bull-90	2015-1785				SEC33-T05S-R25E
AMC 430979	Red Bull-91	2015-1786				SEC33-T05S-R25E
AMC 430980	Red Bull-92	2015-1787				SEC33-T05S-R25E
AMC 430981	Red Bull-93	2015-1788				SEC33-T05S-R25E
AMC 430982	Red Bull-94	2015-1789				SEC33-T05S-R25E
AMC 430983	Red Bull-95	2015-1790				SEC33-T05S-R25E
AMC 430984	Red Bull-96	2015-1791				SEC33-T05S-R25E
AMC 430985	Red Bull-97	2015-1792				SEC33-T05S-R25E
AMC 430986	Red Bull-98	2015-1793				SEC33-T05S-R25E
AMC 430987	Red Bull-99	2015-1794				SEC33-T05S-R25E
AMC 430988	Red Bull-100	2015-1795				SEC33-T05S-R25E
AMC 430989	Red Bull-101	2015-1796				SEC33-T05S-R25E
AMC 430990	Red Bull-102	2015-1797				SEC33-T05S-R25E
AMC 430991	Red Bull-103	2015-1798				SEC33-T05S-R25E
AMC 430992	Red Bull-104	2015-1799				SEC33-T05S-R25E
AMC 430993	Red Bull-105	2015-1800				SEC33-T05S-R25E

Date: 5/23/2018

PHOENIX, ARIZONA

2018 JUN 25 P 1:01

RECEIVED  
BLM AZ STATE OFFICE

## EXHIBIT A

County: Graham

State: AZ

<u>BLM Serial #</u>	<u>Claim Name</u>	<u>Original Recording</u>		<u>Amended Recording</u>		<u>Location</u>
		<u>Recording #</u>	<u>Page #</u>	<u>Recording #</u>	<u>Page #</u>	
AMC 430994	Red Bull-106	2015-1801				SEC33-T05S-R25E
AMC 430995	Red Bull-107	2015-1802				SEC33-T05S-R25E
AMC 430996	Red Bull-108	2015-1803				SEC33-T05S-R25E
AMC 430997	Red Bull-109	2015-1804				SEC28-T05S-R25E
AMC 430998	Red Bull-110	2015-1805				SEC28-T05S-R25E
AMC 430999	Red Bull-111	2015-1806				SEC28-T05S-R25E
AMC 431000	Red Bull-112	2015-1807				SEC28-T05S-R25E
AMC 431001	Red Bull-113	2015-1808				SEC28-T05S-R25E
AMC 431002	Red Bull-114	2015-1809				SEC28-T05S-R25E
AMC 431003	Red Bull-115	2015-1810				SEC28-T05S-R25E
AMC 431004	Red Bull-116	2015-1811				SEC28-T05S-R25E
AMC 431005	Red Bull-117	2015-1812				SEC28-T05S-R25E
AMC 431006	Red Bull-118	2015-1813				SEC28-T05S-R25E
AMC 431007	Red Bull-119	2015-1814				SEC28-T05S-R25E
AMC 431008	Red Bull-120	2015-1815				SEC28-T05S-R25E
AMC 431009	Red Bull-121	2015-1816				SEC28-T05S-R25E
AMC 431010	Red Bull-122	2015-1817				SEC28-T05S-R25E
AMC 431011	Red Bull-123	2015-1818				SEC28-T05S-R25E
AMC 431012	Red Bull-124	2015-1819				SEC28-T05S-R25E
AMC 431013	Red Bull-125	2015-1820				SEC28-T05S-R25E
AMC 431014	Red Bull-126	2015-1821				SEC28-T05S-R25E
AMC 431015	Red Bull-127	2015-1822				SEC28-T05S-R25E
AMC 431016	Red Bull-128	2015-1823				SEC28-T05S-R25E
AMC 431017	Red Bull-129	2015-1824				SEC28-T05S-R25E
AMC 431018	Red Bull-130	2015-1825				SEC28-T05S-R25E
AMC 431019	Red Bull-131	2015-1826				SEC28-T05S-R25E
AMC 431020	Red Bull-132	2015-1827				SEC28-T05S-R25E
AMC 431021	Red Bull-133	2015-1828				SEC28-T05S-R25E
AMC 431022	Red Bull-134	2015-1829				SEC28-T05S-R25E
AMC 431023	Red Bull-135	2015-1830				SEC28-T05S-R25E
AMC 431024	Red Bull-136	2015-1831				SEC28-T05S-R25E
AMC 431025	Red Bull-137	2015-1832				SEC28-T05S-R25E
AMC 431026	Red Bull-138	2015-1833				SEC28-T05S-R25E
AMC 431027	Red Bull-139	2015-1834				SEC28-T05S-R25E
AMC 431028	Red Bull-140	2015-1835				SEC28-T05S-R25E
AMC 431029	Red Bull-141	2015-1836				SEC28-T05S-R25E
AMC 431030	Red Bull-142	2015-1837				SEC28-T05S-R25E
AMC 431031	Red Bull-143	2015-1838				SEC28-T05S-R25E

Date: 5/23/2018

PHOENIX, ARIZONA

2018 JUN 25 P 1:01

RECEIVED  
BLM AZ STATE OFFICE

## EXHIBIT A

County: Graham

State: AZ

<u>BLM Serial #</u>	<u>Claim Name</u>	<u>Original Recording</u>		<u>Amended Recording</u>		<u>Location</u>
		<u>Recording #</u>	<u>Page #</u>	<u>Recording #</u>	<u>Page #</u>	
AMC 431032 7	Red Bull-144	2015-1839				SEC28-T05S-R25E
AMC 431033	Red Bull-316	2015-1840				SEC16-T05S-R25E
AMC 431034	Red Bull-317	2015-1841				SEC16-T05S-R25E
AMC 431035	Red Bull-318	2015-1842				SEC16-T05S-R25E
AMC 431036	Red Bull-319	2015-1843				SEC16-T05S-R25E
AMC 431037	Red Bull-320	2015-1844				SEC16-T05S-R25E
AMC 431038	Red Bull-321	2015-1845				SEC16-T05S-R25E
AMC 431039	Red Bull-322	2015-1846				SEC16-T05S-R25E
AMC 431040	Red Bull-323	2015-1847				SEC16-T05S-R25E
AMC 431041	Red Bull-324	2015-1848				SEC16-T05S-R25E
AMC 431042	Red Bull-325	2015-1849				SEC16-T05S-R25E
AMC 431043	Red Bull-326	2015-1850				SEC16-T05S-R25E
AMC 431044	Red Bull-327	2015-1851				SEC16-T05S-R25E
AMC 431045	Red Bull-328	2015-1852				SEC16-T05S-R25E
AMC 431046	Red Bull-329	2015-1853				SEC16-T05S-R25E
AMC 431047	Red Bull-330	2015-1854				SEC16-T05S-R25E
AMC 431048	Red Bull-331	2015-1855				SEC16-T05S-R25E
AMC 431049	Red Bull-332	2015-1856				SEC16-T05S-R25E
AMC 431050	Red Bull-333	2015-1857				SEC16-T05S-R25E
AMC 431051	Red Bull-334	2015-1858				SEC16-T05S-R25E
AMC 431052	Red Bull-335	2015-1859				SEC16-T05S-R25E
AMC 431053	Red Bull-336	2015-1860				SEC16-T05S-R25E
AMC 431054	Red Bull-337	2015-1861				SEC16-T05S-R25E
AMC 431055	Red Bull-338	2015-1862				SEC16-T05S-R25E
AMC 431056	Red Bull-339	2015-1863				SEC16-T05S-R25E
AMC 431057	Red Bull-340	2015-1864				SEC16-T05S-R25E
AMC 431058	Red Bull-341	2015-1865				SEC16-T05S-R25E
AMC 431059	Red Bull-342	2015-1866				SEC16-T05S-R25E
AMC 431060	Red Bull-343	2015-1867				SEC16-T05S-R25E
AMC 431061	Red Bull-344	2015-1868				SEC16-T05S-R25E
AMC 431062	Red Bull-345	2015-1869				SEC16-T05S-R25E
AMC 431063	Red Bull-346	2015-1870				SEC16-T05S-R25E
AMC 431064	Red Bull-347	2015-1871				SEC16-T05S-R25E
AMC 431065	Red Bull-348	2015-1872				SEC16-T05S-R25E
AMC 431066	Red Bull-349	2015-1873				SEC16-T05S-R25E
AMC 431067	Red Bull-350	2015-1874				SEC16-T05S-R25E
AMC 431068	Red Bull-351	2015-1875				SEC16-T05S-R25E
AMC 431071	ROCKSTAR 123	2015-1913				SEC13-T06S-R27E

Date: 5/23/2018

PHOENIX, ARIZONA

2018 JUN 25 P 1:01

RECEIVED  
BLM AZ STATE OFFICE

## EXHIBIT A

County: Graham

State: AZ

<u>BLM Serial #</u>	<u>Claim Name</u>	<u>Original Recording</u>		<u>Amended Recording</u>		<u>Location</u>
		<u>Recording #</u>	<u>Page #</u>	<u>Recording #</u>	<u>Page #</u>	
AMC 431072	ROCKSTAR 124	2015-1914				SEC13-T06S-R27E
AMC 431073	ROCKSTAR 125	2015-1915				SEC13-T06S-R27E
AMC 431074	ROCKSTAR 126	2015-1916				SEC24-T06S-R27E
AMC 431075	ROCKSTAR 127	2015-1917				SEC13-T06S-R27E
AMC 431076	ROCKSTAR 128	2015-1918				SEC13-T06S-R27E
AMC 431077	ROCKSTAR 129	2015-1919				SEC13-T06S-R27E
AMC 431078	ROCKSTAR 130	2015-1920				SEC13-T06S-R27E
AMC 431079	ROCKSTAR 131	2015-1921				SEC13-T06S-R27E
AMC 431080	ROCKSTAR 132	2015-1922				SEC13-T06S-R27E
AMC 431081	ROCKSTAR 133	2015-1923				SEC13-T06S-R27E
AMC 431082	ROCKSTAR 134	2015-1924				SEC13-T06S-R27E
AMC 431083	ROCKSTAR 135	2015-1925				SEC13-T06S-R27E
AMC 431084	ROCKSTAR 136	2015-1926				SEC13-T06S-R27E
AMC 431085	ROCKSTAR 137	2015-1927				SEC13-T06S-R27E
AMC 431086	ROCKSTAR 138	2015-1928				SEC13-T06S-R27E
AMC 431087	ROCKSTAR 139	2015-1929				SEC13-T06S-R27E
AMC 431088	ROCKSTAR 140	2015-1930				SEC13-T06S-R27E
AMC 431089	ROCKSTAR 141	2015-1931				SEC13-T06S-R27E
AMC 431090	ROCKSTAR 142	2015-1932				SEC13-T06S-R27E
AMC 431091	ROCKSTAR 143	2015-1933				SEC13-T06S-R27E
AMC 431092	ROCKSTAR 144	2015-1934				SEC13-T06S-R27E
AMC 431093	ROCKSTAR 145	2015-1935				SEC13-T06S-R27E
AMC 431094	ROCKSTAR 146	2015-1936				SEC13-T06S-R27E
AMC 431095	ROCKSTAR 147	2015-1937				SEC13-T06S-R27E
AMC 431096	ROCKSTAR 148	2015-1938				SEC13-T06S-R27E
AMC 431097	ROCKSTAR 149	2015-1939				SEC13-T06S-R27E
AMC 431098	ROCKSTAR 150	2015-1940				SEC13-T06S-R27E
AMC 431099	ROCKSTAR 151	2015-1941				SEC24-T06S-R27E
AMC 431100	ROCKSTAR 152	2015-1942				SEC24-T06S-R27E
AMC 431101	ROCKSTAR 153	2015-1943				SEC24-T06S-R27E
AMC 431102	ROCKSTAR 154	2015-1944				SEC24-T06S-R27E
AMC 431103	ROCKSTAR 155	2015-1945				SEC24-T06S-R27E
AMC 431104	ROCKSTAR 156	2015-1946				SEC24-T06S-R27E
AMC 431105	ROCKSTAR 157	2015-1947				SEC24-T06S-R27E
AMC 431106	ROCKSTAR 158	2015-1948				SEC24-T06S-R27E
AMC 431107	ROCKSTAR 159	2015-1949				SEC24-T06S-R27E
AMC 431108	ROCKSTAR 160	2015-1950				SEC24-T06S-R27E
AMC 431109	ROCKSTAR 161	2015-1951				SEC24-T06S-R27E

Date: 5/23/2018

PHOENIX, ARIZONA

2018 JUN 25 P 1:01

RECEIVED  
BLM AZ STATE OFFICE

## EXHIBIT A

County: Graham

State: AZ

<u>BLM Serial #</u>	<u>Claim Name</u>	<u>Original Recording</u>		<u>Amended Recording</u>		<u>Location</u>
		<u>Recording #</u>	<u>Page #</u>	<u>Recording #</u>	<u>Page #</u>	
AMC 431110	ROCKSTAR 162	2015-1952				SEC24-T06S-R27E
AMC 431111	ROCKSTAR 163	2015-1953				SEC24-T06S-R27E
AMC 431112	ROCKSTAR 164	2015-1954				SEC24-T06S-R27E
AMC 431113	ROCKSTAR 165	2015-1955				SEC24-T06S-R27E
AMC 431114	ROCKSTAR 166	2015-1956				SEC24-T06S-R27E
AMC 431115	ROCKSTAR 167	2015-1957				SEC24-T06S-R27E
AMC 431116	ROCKSTAR 168	2015-1958				SEC24-T06S-R27E
AMC 431117	ROCKSTAR 169	2015-1959				SEC24-T06S-R27E
AMC 431118	ROCKSTAR 170	2015-1960				SEC24-T06S-R27E
AMC 431119	ROCKSTAR 171	2015-1961				SEC24-T06S-R27E
AMC 431120	ROCKSTAR 172	2015-1962				SEC23-T06S-R27E
AMC 431121	MONSTER-001	2015-1963				SEC30-T05S-R27E
AMC 431122	MONSTER-002	2015-1964				SEC30-T05S-R27E
AMC 431123	MONSTER-003	2015-1965				SEC30-T05S-R27E
AMC 431124	MONSTER-004	2015-1966				SEC30-T05S-R27E
AMC 431125	MONSTER-005	2015-1967				SEC30-T05S-R27E
AMC 431126	MONSTER-006	2015-1968				SEC30-T05S-R27E
AMC 431127	MONSTER-007	2015-1969				SEC30-T05S-R27E
AMC 431128	MONSTER-008	2015-1970				SEC30-T05S-R27E
AMC 431129	MONSTER-009	2015-1971				SEC30-T05S-R27E
AMC 431130	MONSTER-010	2015-1972				SEC30-T05S-R27E
AMC 431131	MONSTER-011	2015-1973				SEC30-T05S-R27E
AMC 431132	MONSTER-012	2015-1974				SEC30-T05S-R27E
AMC 431133	MONSTER-013	2015-1975				SEC30-T05S-R27E
AMC 431134	MONSTER-014	2015-1976				SEC30-T05S-R27E
AMC 431135	MONSTER-015	2015-1977				SEC30-T05S-R27E
AMC 431136	MONSTER-016	2015-1978				SEC30-T05S-R27E
AMC 431137	MONSTER-017	2015-1979				SEC30-T05S-R27E
AMC 431138	MONSTER-018	2015-1980				SEC30-T05S-R27E
AMC 431139	MONSTER-019	2015-1981				SEC30-T05S-R27E
AMC 431140	MONSTER-020	2015-1982				SEC30-T05S-R27E
AMC 431141	MONSTER-021	2015-1983				SEC30-T05S-R27E
AMC 431142	MONSTER-022	2015-1984				SEC30-T05S-R27E
AMC 431143	MONSTER-023	2015-1985				SEC30-T05S-R27E
AMC 431144	MONSTER-024	2015-1986				SEC30-T05S-R27E
AMC 431145	MONSTER-025	2015-1987				SEC30-T05S-R27E
AMC 431146	MONSTER-026	2015-1988				SEC30-T05S-R27E
AMC 431147	MONSTER-027	2015-1989				SEC30-T05S-R27E

Date: 5/23/2018

RECEIVED  
 BLM AZ STATE OFFICE  
 2018 JUN 25 P 1:01  
 PHOENIX, ARIZONA

## EXHIBIT A

County: Graham

State: AZ

<u>BLM Serial #</u>	<u>Claim Name</u>	<u>Original Recording</u>		<u>Amended Recording</u>		<u>Location</u>
		<u>Recording #</u>	<u>Page #</u>	<u>Recording #</u>	<u>Page #</u>	
AMC 431148	MONSTER-028	2015-1990				SEC30-T05S-R27E
AMC 431149	MONSTER-029	2015-1991				SEC30-T05S-R27E
AMC 431150	MONSTER-030	2015-1992				SEC30-T05S-R27E
AMC 431151	MONSTER-031	2015-1993				SEC30-T05S-R27E
AMC 431152	MONSTER-032	2015-1994				SEC30-T05S-R27E
AMC 431153	MONSTER-033	2015-1995				SEC30-T05S-R27E
AMC 431154	MONSTER-034	2015-1996				SEC30-T05S-R27E
AMC 431155	MONSTER-035	2015-1997				SEC30-T05S-R27E
AMC 431156	MONSTER-036	2015-1998				SEC30-T05S-R27E
AMC 431157	MONSTER-037	2015-1999				SEC29-T05S-R27E
AMC 431158	MONSTER-038	2015-2000				SEC29-T05S-R27E
AMC 431159	MONSTER-039	2015-2001				SEC29-T05S-R27E
AMC 431160	MONSTER-040	2015-2002				SEC29-T05S-R27E
AMC 431161	MONSTER-041	2015-2003				SEC29-T05S-R27E
AMC 431162	MONSTER-042	2015-2004				SEC29-T05S-R27E
AMC 431163	MONSTER-043	2015-2005				SEC29-T05S-R27E
AMC 431164	MONSTER-044	2015-2006				SEC29-T05S-R27E
AMC 431165	MONSTER-045	2015-2007				SEC29-T05S-R27E
AMC 431166	MONSTER-046	2015-2008				SEC29-T05S-R27E
AMC 431167	MONSTER-047	2015-2009				SEC29-T05S-R27E
AMC 431168	MONSTER-048	2015-2010				SEC29-T05S-R27E
AMC 431169	MONSTER-049	2015-2011				SEC29-T05S-R27E
AMC 431170	MONSTER-050	2015-2012				SEC29-T05S-R27E
AMC 431171	MONSTER-051	2015-2013				SEC29-T05S-R27E
AMC 431172	MONSTER-052	2015-2014				SEC29-T05S-R27E
AMC 431173	MONSTER-053	2015-2015				SEC29-T05S-R27E
AMC 431174	MONSTER-054	2015-2016				SEC29-T05S-R27E
AMC 431175	MONSTER-055	2015-2017				SEC29-T05S-R27E
AMC 431176	MONSTER-056	2015-2018				SEC29-T05S-R27E
AMC 431177	MONSTER-057	2015-2019				SEC29-T05S-R27E
AMC 431178	MONSTER-058	2015-2020				SEC29-T05S-R27E
AMC 431179	MONSTER-059	2015-2021				SEC29-T05S-R27E
AMC 431180	MONSTER-060	2015-2022				SEC29-T05S-R27E
AMC 431181	MONSTER-061	2015-2023				SEC29-T05S-R27E
AMC 431182	MONSTER-062	2015-2024				SEC29-T05S-R27E
AMC 431183	MONSTER-063	2015-2025				SEC29-T05S-R27E
AMC 431184	MONSTER-064	2015-2026				SEC29-T05S-R27E
AMC 431185	MONSTER-065	2015-2027				SEC29-T05S-R27E

Date: 5/23/2018

RECEIVED  
BLM AZ STATE OFFICE  
JUN 25 P 1:01  
PHOENIX, ARIZONA

## EXHIBIT A

County: Graham

State: AZ

<u>BLM Serial #</u>	<u>Claim Name</u>	<u>Original Recording</u>		<u>Amended Recording</u>		<u>Location</u>
		<u>Recording #</u>	<u>Page #</u>	<u>Recording #</u>	<u>Page #</u>	
AMC 431186	MONSTER-066	2015-2028				SEC29-T05S-R27E
AMC 431187	MONSTER-067	2015-2029				SEC29-T05S-R27E
AMC 431188	MONSTER-068	2015-2030				SEC29-T05S-R27E
AMC 431189	MONSTER-069	2015-2031				SEC29-T05S-R27E
AMC 431190	MONSTER-070	2015-2032				SEC29-T05S-R27E
AMC 431191	MONSTER-071	2015-2033				SEC29-T05S-R27E
AMC 431192	MONSTER-072	2015-2034				SEC29-T05S-R27E
AMC 431193	MONSTER-073	2015-2035				SEC28-T05S-R27E
AMC 431194	MONSTER-074	2015-2036				SEC28-T05S-R27E
AMC 431195	MONSTER-075	2015-2037				SEC28-T05S-R27E
AMC 431196	MONSTER-076	2015-2038				SEC28-T05S-R27E
AMC 431197	MONSTER-077	2015-2039				SEC28-T05S-R27E
AMC 431198	MONSTER-078	2015-2040				SEC28-T05S-R27E
AMC 431199	MONSTER-079	2015-2041				SEC28-T05S-R27E
AMC 431200	MONSTER-080	2015-2042				SEC28-T05S-R27E
AMC 431201	MONSTER-081	2015-2043				SEC28-T05S-R27E
AMC 431202	MONSTER-082	2015-2044				SEC28-T05S-R27E
AMC 431203	MONSTER-083	2015-2045				SEC28-T05S-R27E
AMC 431204	MONSTER-084	2015-2046				SEC28-T05S-R27E
AMC 431205	MONSTER-085	2015-2047				SEC28-T05S-R27E
AMC 431206	MONSTER-086	2015-2048				SEC28-T05S-R27E
AMC 431207	MONSTER-087	2015-2049				SEC28-T05S-R27E
AMC 431208	MONSTER-088	2015-2050				SEC28-T05S-R27E
AMC 431209	MONSTER-089	2015-2051				SEC28-T05S-R27E
AMC 431210	MONSTER-090	2015-2052				SEC28-T05S-R27E
AMC 431211	MONSTER-091	2015-2053				SEC28-T05S-R27E
AMC 431212	MONSTER-092	2015-2054				SEC28-T05S-R27E
AMC 431213	MONSTER-093	2015-2055				SEC28-T05S-R27E
AMC 431214	MONSTER-094	2015-2056				SEC28-T05S-R27E
AMC 431215	MONSTER-095	2015-2057				SEC28-T05S-R27E
AMC 431216	MONSTER-096	2015-2058				SEC28-T05S-R27E
AMC 431217	MONSTER-097	2015-2059				SEC28-T05S-R27E
AMC 431218	MONSTER-098	2015-2060				SEC28-T05S-R27E
AMC 431219	MONSTER-099	2015-2061				SEC28-T05S-R27E
AMC 431220	MONSTER-100	2015-2062				SEC28-T05S-R27E
AMC 431221	MONSTER-101	2015-2063				SEC28-T05S-R27E
AMC 431222	MONSTER-102	2015-2064				SEC28-T05S-R27E
AMC 431223	MONSTER-103	2015-2065				SEC28-T05S-R27E

Date: 5/23/2018

RECEIVED  
 BLM AZ STATE OFFICE  
 2018 JUN 25 P 1:01  
 PHOENIX, ARIZONA



EXHIBIT A

County: Graham

State: AZ

<u>BLM Serial #</u>	<u>Claim Name</u>	<u>Original Recording</u>		<u>Amended Recording</u>		<u>Location</u>
		<u>Recording #</u>	<u>Page #</u>	<u>Recording #</u>	<u>Page #</u>	
AMC 431224	MONSTER-104	2015-2066				SEC28-T05S-R27E
AMC 431225	MONSTER-105	2015-2067				SEC28-T05S-R27E
AMC 431226	MONSTER-106	2015-2068				SEC28-T05S-R27E
AMC 431227	MONSTER-107	2015-2069				SEC28-T05S-R27E
AMC 431228	MONSTER-108	2015-2070				SEC28-T05S-R27E
AMC 431229	MONSTER-149	2015-2071				SEC34-T05S-R27E
AMC 431230	MONSTER-150	2015-2072				SEC34-T05S-R27E
AMC 431231	MONSTER-159	2015-2073				SEC34-T05S-R27E
AMC 431232	MONSTER-160	2015-2074				SEC34-T05S-R27E
AMC 431233	MONSTER-161	2015-2075				SEC34-T05S-R27E
AMC 431234	MONSTER-162	2015-2076				SEC34-T05S-R27E
AMC 431235	MONSTER-163	2015-2077				SEC34-T05S-R27E
AMC 431236	MONSTER-164	2015-2078				SEC34-T05S-R27E
AMC 431237	MONSTER-165	2015-2079				SEC34-T05S-R27E
AMC 431238	MONSTER-166	2015-2080				SEC34-T05S-R27E
AMC 431239	MONSTER-167	2015-2081				SEC34-T05S-R27E
AMC 431240	MONSTER-168	2015-2082				SEC34-T05S-R27E
AMC 431241	MONSTER-169	2015-2083				SEC34-T05S-R27E
AMC 431242	MONSTER-170	2015-2084				SEC34-T05S-R27E
AMC 431243	MONSTER-171	2015-2085				SEC34-T05S-R27E
AMC 431244	MONSTER-172	2015-2086				SEC34-T05S-R27E
AMC 431245	MONSTER-173	2015-2087				SEC34-T05S-R27E
AMC 431246	MONSTER-174	2015-2088				SEC34-T05S-R27E
AMC 431247	MONSTER-175	2015-2089				SEC34-T05S-R27E
AMC 431248	MONSTER-176	2015-2090				SEC34-T05S-R27E
AMC 431249	MONSTER-331	2015-2091				SEC19-T05S-R27E
AMC 431250	MONSTER-332	2015-2092				SEC19-T05S-R27E
AMC 431251	MONSTER-333	2015-2093				SEC19-T05S-R27E
AMC 431252	MONSTER-334	2015-2094				SEC19-T05S-R27E
AMC 431253	MONSTER-335	2015-2095				SEC19-T05S-R27E
AMC 431254	MONSTER-336	2015-2096				SEC19-T05S-R27E
AMC 431255	MONSTER-337	2015-2097				SEC19-T05S-R27E
AMC 431256	MONSTER-338	2015-2098				SEC19-T05S-R27E
AMC 431257	MONSTER-339	2015-2099				SEC19-T05S-R27E
AMC 431258	MONSTER-340	2015-2100				SEC19-T05S-R27E
AMC 431259	MONSTER-341	2015-2101				SEC19-T05S-R27E
AMC 431260	MONSTER-342	2015-2102				SEC19-T05S-R27E
AMC 431261	MONSTER-343	2015-2103				SEC19-T05S-R27E

Date: 5/23/2018

PHOENIX, ARIZONA

2018 JUN 25 P 1:01

RECEIVED  
BLM AZ STATE OFFICE

## EXHIBIT A

County: Graham

State: AZ

<u>BLM Serial #</u>	<u>Claim Name</u>	<u>Original Recording</u>		<u>Amended Recording</u>		<u>Location</u>
		<u>Recording #</u>	<u>Page #</u>	<u>Recording #</u>	<u>Page #</u>	
AMC 431262	MONSTER-344	2015-2104				SEC19-T05S-R27E
AMC 431263	MONSTER-345	2015-2105				SEC19-T05S-R27E
AMC 431264	MONSTER-346	2015-2106				SEC19-T05S-R27E
AMC 431265	MONSTER-347	2015-2107				SEC19-T05S-R27E
AMC 431266	MONSTER-348	2015-2108				SEC19-T05S-R27E
AMC 431267	MONSTER-349	2015-2109				SEC19-T05S-R27E
AMC 431268	MONSTER-350	2015-2110				SEC19-T05S-R27E
AMC 431269	MONSTER-351	2015-2111				SEC19-T05S-R27E
AMC 431270	MONSTER-352	2015-2112				SEC19-T05S-R27E
AMC 431271	MONSTER-353	2015-2113				SEC19-T05S-R27E
AMC 431272	MONSTER-354	2015-2114				SEC19-T05S-R27E
AMC 431273	MONSTER-355	2015-2115				SEC19-T05S-R27E
AMC 431274	MONSTER-356	2015-2116				SEC19-T05S-R27E
AMC 431275	MONSTER-357	2015-2117				SEC19-T05S-R27E
AMC 431276	MONSTER-358	2015-2118				SEC19-T05S-R27E
AMC 431277	MONSTER-359	2015-2119				SEC19-T05S-R27E
AMC 431278	MONSTER-360	2015-2120				SEC19-T05S-R27E
AMC 431279	MONSTER-361	2015-2121				SEC19-T05S-R27E
AMC 431280	MONSTER-362	2015-2122				SEC19-T05S-R27E
AMC 431281	MONSTER-363	2015-2123				SEC19-T05S-R27E
AMC 431282	MONSTER-364	2015-2124				SEC19-T05S-R27E
AMC 431283	MONSTER-365	2015-2125				SEC19-T05S-R27E
AMC 431284	MONSTER-366	2015-2126				SEC19-T05S-R27E
AMC 431317	Red Bull-145	2015-2200				SEC29-T05S-R25E
AMC 431318	Red Bull-146	2015-2201				SEC29-T05S-R25E
AMC 431319	Red Bull-147	2015-2202				SEC29-T05S-R25E
AMC 431320	Red Bull-148	2015-2203				SEC29-T05S-R25E
AMC 431321	Red Bull-149	2015-2204				SEC29-T05S-R25E
AMC 431322	Red Bull-150	2015-2205				SEC29-T05S-R25E
AMC 431323	Red Bull-151	2015-2206				SEC29-T05S-R25E
AMC 431324	Red Bull-152	2015-2207				SEC29-T05S-R25E
AMC 431325	Red Bull-153	2015-2208				SEC29-T05S-R25E
AMC 431326	Red Bull-154	2015-2209				SEC29-T05S-R25E
AMC 431327	Red Bull-155	2015-2210				SEC29-T05S-R25E
AMC 431328	Red Bull-156	2015-2211				SEC29-T05S-R25E
AMC 431329	Red Bull-157	2015-2212				SEC29-T05S-R25E
AMC 431330	Red Bull-158	2015-2213				SEC29-T05S-R25E
AMC 431331	Red Bull-159	2015-2214				SEC29-T05S-R25E

Date: 5/23/2018

RECEIVED  
BLM AZ STATE OFFICE  
JUN 25 P 1:01  
PHOENIX, ARIZONA

## EXHIBIT A

County: Graham

State: AZ

BLM Serial #	Claim Name	Original Recording		Amended Recording		Location
		Recording #	Page #	Recording #	Page #	
AMC 431332 7	Red Bull-160	2015-2215				SEC29-T05S-R25E
AMC 431333	Red Bull-161	2015-2216				SEC29-T05S-R25E
AMC 431334	Red Bull-162	2015-2217				SEC29-T05S-R25E
AMC 431335	Red Bull-163	2015-2218				SEC29-T05S-R25E
AMC 431336	Red Bull-164	2015-2219				SEC29-T05S-R25E
AMC 431337	Red Bull-165	2015-2220				SEC29-T05S-R25E
AMC 431338	Red Bull-166	2015-2221				SEC29-T05S-R25E
AMC 431339	Red Bull-167	2015-2222				SEC29-T05S-R25E
AMC 431340	Red Bull-168	2015-2223				SEC29-T05S-R25E
AMC 431341	Red Bull-169	2015-2224				SEC29-T05S-R25E
AMC 431342	Red Bull-170	2015-2225				SEC29-T05S-R25E
AMC 431343	Red Bull-171	2015-2226				SEC29-T05S-R25E
AMC 431344	Red Bull-172	2015-2227				SEC29-T05S-R25E
AMC 431345	Red Bull-173	2015-2228				SEC29-T05S-R25E
AMC 431346	Red Bull-174	2015-2229				SEC29-T05S-R25E
AMC 431347	Red Bull-175	2015-2230				SEC29-T05S-R25E
AMC 431348	Red Bull-176	2015-2231				SEC29-T05S-R25E
AMC 431349	Red Bull-177	2015-2232				SEC29-T05S-R25E
AMC 431350	Red Bull-178	2015-2233				SEC29-T05S-R25E
AMC 431351	Red Bull-179	2015-2234				SEC29-T05S-R25E
AMC 431352	Red Bull-180	2015-2235				SEC29-T05S-R25E
AMC 431353	Red Bull-181	2015-2236				SEC30-T05S-R25E
AMC 431354	Red Bull-182	2015-2237				SEC30-T05S-R25E
AMC 431355	Red Bull-183	2015-2238				SEC30-T05S-R25E
AMC 431356	Red Bull-184	2015-2239				SEC30-T05S-R25E
AMC 431357	Red Bull-185	2015-2240				SEC30-T05S-R25E
AMC 431358	Red Bull-186	2015-2241				SEC30-T05S-R25E
AMC 431359	Red Bull-187	2015-2242				SEC30-T05S-R25E
AMC 431360	Red Bull-188	2015-2243				SEC30-T05S-R25E
AMC 431361	Red Bull-189	2015-2244				SEC30-T05S-R25E
AMC 431362	Red Bull-190	2015-2245				SEC30-T05S-R25E
AMC 431363	Red Bull-191	2015-2246				SEC30-T05S-R25E
AMC 431364	Red Bull-192	2015-2247				SEC30-T05S-R25E
AMC 431365	Red Bull-193	2015-2248				SEC30-T05S-R25E
AMC 431366	Red Bull-194	2015-2249				SEC30-T05S-R25E
AMC 431367	Red Bull-195	2015-2250				SEC30-T05S-R25E
AMC 431368	Red Bull-196	2015-2251				SEC30-T05S-R25E
AMC 431369	Red Bull-197	2015-2252				SEC30-T05S-R25E

Date: 5/23/2018

RECEIVED  
BLM AZ STATE OFFICE  
2018 JUN 25 P 1:01  
PHOENIX, ARIZONA

## EXHIBIT A

County: Graham

State: AZ

<u>BLM Serial #</u>	<u>Claim Name</u>	<u>Original Recording</u>		<u>Amended Recording</u>		<u>Location</u>
		<u>Recording #</u>	<u>Page #</u>	<u>Recording #</u>	<u>Page #</u>	
AMC 431370	Red Bull-198	2015-2253				SEC30-T05S-R25E
AMC 431371	Red Bull-199	2015-2254				SEC30-T05S-R25E
AMC 431372	Red Bull-200	2015-2255				SEC30-T05S-R25E
AMC 431373	Red Bull-201	2015-2256				SEC30-T05S-R25E
AMC 431374	Red Bull-202	2015-2257				SEC30-T05S-R25E
AMC 431375	Red Bull-203	2015-2258				SEC30-T05S-R25E
AMC 431376	Red Bull-204	2015-2259				SEC30-T05S-R25E
AMC 431377	Red Bull-205	2015-2260				SEC30-T05S-R25E
AMC 431378	Red Bull-206	2015-2261				SEC30-T05S-R25E
AMC 431379	Red Bull-207	2015-2262				SEC30-T05S-R25E
AMC 431380	Red Bull-208	2015-2263				SEC30-T05S-R25E
AMC 431381	Red Bull-209	2015-2264				SEC30-T05S-R25E
AMC 431382	Red Bull-210	2015-2265				SEC30-T05S-R25E
AMC 431383	Red Bull-211	2015-2266				SEC30-T05S-R25E
AMC 431384	Red Bull-212	2015-2267				SEC30-T05S-R25E
AMC 431385	Red Bull-213	2015-2268				SEC30-T05S-R25E
AMC 431386	Red Bull-214	2015-2269				SEC30-T05S-R25E
AMC 431387	Red Bull-215	2015-2270				SEC30-T05S-R25E
AMC 431388	Red Bull-216	2015-2271				SEC30-T05S-R25E
AMC 431389	Red Bull-217	2015-2272				SEC19-T05S-R25E
AMC 431390	Red Bull-218	2015-2273				SEC19-T05S-R25E
AMC 431391	Red Bull-219	2015-2274				SEC19-T05S-R25E
AMC 431392	Red Bull-220	2015-2275				SEC19-T05S-R25E
AMC 431393	Red Bull-221	2015-2276				SEC19-T05S-R25E
AMC 431394	Red Bull-222	2015-2277				SEC19-T05S-R25E
AMC 431395	Red Bull-223	2015-2278				SEC19-T05S-R25E
AMC 431396	Red Bull-224	2015-2279				SEC19-T05S-R25E
AMC 431397	Red Bull-225	2015-2280				SEC19-T05S-R25E
AMC 431398	Red Bull-226	2015-2281				SEC19-T05S-R25E
AMC 431399	Red Bull-227	2015-2282				SEC19-T05S-R25E
AMC 431400	Red Bull-228	2015-2283				SEC19-T05S-R25E
AMC 431401	Red Bull-229	2015-2284				SEC19-T05S-R25E
AMC 431402	Red Bull-230	2015-2285				SEC19-T05S-R25E
AMC 431403	Red Bull-231	2015-2286				SEC19-T05S-R25E
AMC 431404	Red Bull-232	2015-2287				SEC19-T05S-R25E
AMC 431405	Red Bull-233	2015-2288				SEC19-T05S-R25E
AMC 431406	Red Bull-234	2015-2289				SEC19-T05S-R25E
AMC 431407	Red Bull-235	2015-2290				SEC19-T05S-R25E

Date: 5/23/2018

PHOENIX, ARIZONA

2018 JUN 25 P 1:01

RECEIVED  
BLM AZ STATE OFFICE

**EXHIBIT A**

County: Graham

State: AZ

<u>BLM Serial #</u>	<u>Claim Name</u>	<u>Original Recording</u>		<u>Amended Recording</u>		<u>Location</u>
		<u>Recording #</u>	<u>Page #</u>	<u>Recording #</u>	<u>Page #</u>	
AMC 431408	Red Bull-236	2015-2291				SEC19-T05S-R25E
AMC 431409	Red Bull-237	2015-2292				SEC19-T05S-R25E
AMC 431410	Red Bull-238	2015-2293				SEC19-T05S-R25E
AMC 431411	Red Bull-239	2015-2294				SEC19-T05S-R25E
AMC 431412	Red Bull-240	2015-2295				SEC19-T05S-R25E
AMC 431413	Red Bull-241	2015-2296				SEC19-T05S-R25E
AMC 431414	Red Bull-242	2015-2297				SEC19-T05S-R25E
AMC 431415	Red Bull-243	2015-2298				SEC19-T05S-R25E
AMC 431416	Red Bull-244	2015-2299				SEC20-T05S-R25E
AMC 431417	Red Bull-245	2015-2300				SEC20-T05S-R25E
AMC 431418	Red Bull-246	2015-2301				SEC20-T05S-R25E
AMC 431419	Red Bull-247	2015-2302				SEC20-T05S-R25E
AMC 431420	Red Bull-248	2015-2303				SEC20-T05S-R25E
AMC 431421	Red Bull-249	2015-2304				SEC20-T05S-R25E
AMC 431422	Red Bull-250	2015-2305				SEC20-T05S-R25E
AMC 431423	Red Bull-251	2015-2306				SEC20-T05S-R25E
AMC 431424	Red Bull-252	2015-2307				SEC20-T05S-R25E
AMC 431425	Red Bull-253	2015-2308				SEC20-T05S-R25E
AMC 431426	Red Bull-254	2015-2309				SEC20-T05S-R25E
AMC 431427	Red Bull-255	2015-2310				SEC20-T05S-R25E
AMC 431428	Red Bull-256	2015-2311				SEC20-T05S-R25E
AMC 431429	Red Bull-257	2015-2312				SEC20-T05S-R25E
AMC 431430	Red Bull-258	2015-2313				SEC20-T05S-R25E
AMC 431431	Red Bull-259	2015-2314				SEC20-T05S-R25E
AMC 431432	Red Bull-260	2015-2315				SEC20-T05S-R25E
AMC 431433	Red Bull-261	2015-2316				SEC20-T05S-R25E
AMC 431434	Red Bull-262	2015-2317				SEC20-T05S-R25E
AMC 431435	Red Bull-263	2015-2318				SEC20-T05S-R25E
AMC 431436	Red Bull-264	2015-2319				SEC20-T05S-R25E
AMC 431437	Red Bull-265	2015-2320				SEC20-T05S-R25E
AMC 431438	Red Bull-266	2015-2321				SEC20-T05S-R25E
AMC 431439	Red Bull-267	2015-2322				SEC20-T05S-R25E
AMC 431440	Red Bull-268	2015-2323				SEC20-T05S-R25E
AMC 431441	Red Bull-269	2015-2324				SEC20-T05S-R25E
AMC 431442	Red Bull-270	2015-2325				SEC20-T05S-R25E
AMC 431443	Red Bull-271	2015-2326				SEC20-T05S-R25E
AMC 431444	Red Bull-272	2015-2327				SEC20-T05S-R25E
AMC 431445	Red Bull-273	2015-2328				SEC20-T05S-R25E

Date: 5/23/2018

PHOENIX, ARIZONA

2018 JUN 25 P 1:01

RECEIVED  
BLM AZ STATE OFFICE

## EXHIBIT A

County: Graham

State: AZ

<u>BLM Serial #</u>	<u>Claim Name</u>	<u>Original Recording</u>		<u>Amended Recording</u>		<u>Location</u>
		<u>Recording #</u>	<u>Page #</u>	<u>Recording #</u>	<u>Page #</u>	
AMC 431446	Red Bull-274	2015-2329				SEC20-T05S-R25E
AMC 431447	Red Bull-275	2015-2330				SEC20-T05S-R25E
AMC 431448	Red Bull-276	2015-2331				SEC20-T05S-R25E
AMC 431449	Red Bull-277	2015-2332				SEC20-T05S-R25E
AMC 431450	Red Bull-278	2015-2333				SEC20-T05S-R25E
AMC 431451	Red Bull-279	2015-2334				SEC20-T05S-R25E
AMC 431452	Red Bull-280	2015-2335				SEC21-T05S-R25E
AMC 431453	Red Bull-281	2015-2336				SEC21-T05S-R25E
AMC 431454	Red Bull-282	2015-2337				SEC21-T05S-R25E
AMC 431455	Red Bull-283	2015-2338				SEC21-T05S-R25E
AMC 431456	Red Bull-284	2015-2339				SEC21-T05S-R25E
AMC 431457	Red Bull-285	2015-2340				SEC21-T05S-R25E
AMC 431458	Red Bull-286	2015-2341				SEC21-T05S-R25E
AMC 431459	Red Bull-287	2015-2342				SEC21-T05S-R25E
AMC 431460	Red Bull-288	2015-2343				SEC21-T05S-R25E
AMC 431461	Red Bull-289	2015-2344				SEC21-T05S-R25E
AMC 431462	Red Bull-290	2015-2345				SEC21-T05S-R25E
AMC 431463	Red Bull-291	2015-2346				SEC21-T05S-R25E
AMC 431464	Red Bull-292	2015-2347				SEC21-T05S-R25E
AMC 431465	Red Bull-293	2015-2348				SEC21-T05S-R25E
AMC 431466	Red Bull-294	2015-2349				SEC21-T05S-R25E
AMC 431467	Red Bull-295	2015-2350				SEC21-T05S-R25E
AMC 431468	Red Bull-296	2015-2351				SEC21-T05S-R25E
AMC 431469	Red Bull-297	2015-2352				SEC21-T05S-R25E
AMC 431470	Red Bull-298	2015-2353				SEC21-T05S-R25E
AMC 431471	Red Bull-299	2015-2354				SEC21-T05S-R25E
AMC 431472	Red Bull-300	2015-2355				SEC21-T05S-R25E
AMC 431473	Red Bull-301	2015-2356				SEC21-T05S-R25E
AMC 431474	Red Bull-302	2015-2357				SEC21-T05S-R25E
AMC 431475	Red Bull-303	2015-2358				SEC21-T05S-R25E
AMC 431476	Red Bull-304	2015-2359				SEC21-T05S-R25E
AMC 431477	Red Bull-305	2015-2360				SEC21-T05S-R25E
AMC 431478	Red Bull-306	2015-2361				SEC21-T05S-R25E
AMC 431479	Red Bull-307	2015-2362				SEC21-T05S-R25E
AMC 431480	Red Bull-308	2015-2363				SEC21-T05S-R25E
AMC 431481	Red Bull-309	2015-2364				SEC21-T05S-R25E
AMC 431482	Red Bull-310	2015-2365				SEC21-T05S-R25E
AMC 431483	Red Bull-311	2015-2366				SEC21-T05S-R25E

Date: 5/23/2018

RECEIVED  
BLM AZ STATE OFFICE  
2016 JUN 25 P 1:02  
PHOENIX, ARIZONA

## EXHIBIT A

County: Graham

State: AZ

<u>BLM Serial #</u>	<u>Claim Name</u>	<u>Original Recording</u>		<u>Amended Recording</u>		<u>Location</u>
		<u>Recording #</u>	<u>Page #</u>	<u>Recording #</u>	<u>Page #</u>	
AMC 431484	Red Bull-312	2015-2367				SEC21-T05S-R25E
AMC 431485	Red Bull-313	2015-2368				SEC21-T05S-R25E
AMC 431486	Red Bull-314	2015-2369				SEC21-T05S-R25E
AMC 431487	Red Bull-315	2015-2370				SEC21-T05S-R25E
AMC 431488	Red Bull-379	2015-2130				SEC14-T05S-R25E
AMC 431489	Red Bull-380	2015-2131				SEC14-T05S-R25E
AMC 431490	Red Bull-381	2015-2132				SEC14-T05S-R25E
AMC 431491	Red Bull-382	2015-2133				SEC14-T05S-R25E
AMC 431492	Red Bull-383	2015-2134				SEC14-T05S-R25E
AMC 431493	Red Bull-384	2015-2135				SEC14-T05S-R25E
AMC 431494	Red Bull-385	2015-2136				SEC14-T05S-R25E
AMC 431495	Red Bull-386	2015-2137				SEC14-T05S-R25E
AMC 431496	Red Bull-387	2015-2138				SEC14-T05S-R25E
AMC 431497	Red Bull-388	2015-2139				SEC14-T05S-R25E
AMC 431498	Red Bull-389	2015-2140				SEC14-T05S-R25E
AMC 431499	Red Bull-390	2015-2141				SEC14-T05S-R25E
AMC 431500	Red Bull-391	2015-2142				SEC14-T05S-R25E
AMC 431501	Red Bull-392	2015-2143				SEC14-T05S-R25E
AMC 431502	Red Bull-393	2015-2144				SEC14-T05S-R25E
AMC 431503	Red Bull-394	2015-2145				SEC14-T05S-R25E
AMC 431504	Red Bull-395	2015-2146				SEC14-T05S-R25E
AMC 431505	Red Bull-396	2015-2147				SEC14-T05S-R25E
AMC 431542	Red Bull-469	2015-2184				SEC23-T05S-R25E
AMC 431543	Red Bull-470	2015-2185				SEC23-T05S-R25E
AMC 431544	Red Bull-471	2015-2186				SEC23-T05S-R25E
AMC 431545	Red Bull-472	2015-2187				SEC23-T05S-R25E
AMC 431546	Red Bull-473	2015-2188				SEC23-T05S-R25E
AMC 431547	Red Bull-474	2015-2189				SEC23-T05S-R25E
AMC 431548	Red Bull-475	2015-2190				SEC23-T05S-R25E
AMC 431549	Red Bull-476	2015-2191				SEC23-T05S-R25E
AMC 431550	Red Bull-477	2015-2192				SEC23-T05S-R25E
AMC 431551	Red Bull-478	2015-2193				SEC23-T05S-R25E
AMC 431552	Red Bull-479	2015-2194				SEC23-T05S-R25E
AMC 431553	Red Bull-480	2015-2195				SEC23-T05S-R25E
AMC 431554	Red Bull-481	2015-2196				SEC23-T05S-R25E
AMC 431555	Red Bull-482	2015-2197				SEC23-T05S-R25E
AMC 431556	Red Bull-483	2015-2198				SEC23-T05S-R25E
AMC 431557	Red Bull-484	2015-2199				SEC23-T05S-R25E

Date: 5/23/2018

RECEIVED  
BLM AZ STATE OFFICE  
2018 JUN 25 P 1:02  
PHOENIX, ARIZONA

## EXHIBIT A

County: Graham

State: AZ

<u>BLM Serial #</u>	<u>Claim Name</u>	<u>Original Recording</u>		<u>Amended Recording</u>		<u>Location</u>
		<u>Recording #</u>	<u>Page #</u>	<u>Recording #</u>	<u>Page #</u>	
AMC 431566	ROCKSTAR 173	2015-2450				SEC36-T06S-R27E
AMC 431567	ROCKSTAR 174	2015-2451				SEC36-T06S-R27E
AMC 431568	ROCKSTAR 175	2015-2452				SEC36-T06S-R27E
AMC 431569	ROCKSTAR 176	2015-2453				SEC36-T06S-R27E
AMC 431570	ROCKSTAR 177	2015-2454				SEC36-T06S-R27E
AMC 431571	ROCKSTAR 178	2015-2455				SEC36-T06S-R27E
AMC 431572	ROCKSTAR 179	2015-2456				SEC35-T06S-R27E
AMC 431573	ROCKSTAR 180	2015-2457				SEC35-T06S-R27E
AMC 431574	ROCKSTAR 181	2015-2458				SEC35-T06S-R27E
AMC 431575	ROCKSTAR 182	2015-2459				SEC35-T06S-R27E
AMC 431576	ROCKSTAR 183	2015-2460				SEC35-T06S-R27E
AMC 431577	ROCKSTAR 184	2015-2461				SEC35-T06S-R27E
AMC 431578	ROCKSTAR 185	2015-2462				SEC35-T06S-R27E
AMC 431579	ROCKSTAR 186	2015-2463				SEC35-T06S-R27E
AMC 431580	ROCKSTAR 187	2015-2464				SEC35-T06S-R27E
AMC 431581	ROCKSTAR 188	2015-2465				SEC35-T06S-R27E
AMC 431582	ROCKSTAR 189	2015-2466				SEC35-T06S-R27E
AMC 431583	ROCKSTAR 190	2015-2467				SEC35-T06S-R27E
AMC 431584	ROCKSTAR 191	2015-2468				SEC35-T06S-R27E
AMC 431585	ROCKSTAR 192	2015-2469				SEC35-T06S-R27E
AMC 431586	ROCKSTAR 193	2015-2470				SEC35-T06S-R27E
AMC 431587	ROCKSTAR 194	2015-2471				SEC35-T06S-R27E
AMC 431588	ROCKSTAR 195	2015-2472				SEC35-T06S-R27E
AMC 431589	ROCKSTAR 196	2015-2473				SEC35-T06S-R27E
AMC 431590	ROCKSTAR 197	2015-2474				SEC34-T06S-R27E
AMC 431591	ROCKSTAR 198	2015-2475				SEC34-T06S-R27E
AMC 431592	ROCKSTAR 199	2015-2476				SEC34-T06S-R27E
AMC 431593	ROCKSTAR 200	2015-2477				SEC34-T06S-R27E
AMC 431594	ROCKSTAR 201	2015-2478				SEC34-T06S-R27E
AMC 431595	ROCKSTAR 202	2015-2479				SEC34-T06S-R27E
AMC 431596	ROCKSTAR 203	2015-2480				SEC34-T06S-R27E
AMC 431597	ROCKSTAR 204	2015-2481				SEC34-T06S-R27E
AMC 431598	ROCKSTAR 205	2015-2482				SEC34-T06S-R27E
AMC 431599	ROCKSTAR 206	2015-2483				SEC34-T06S-R27E
AMC 431600	ROCKSTAR 207	2015-2484				SEC34-T06S-R27E
AMC 431601	ROCKSTAR 208	2015-2485				SEC34-T06S-R27E
AMC 431602	ROCKSTAR 209	2015-2486				SEC35-T06S-R27E
AMC 431603	ROCKSTAR 210	2015-2487				SEC27-T06S-R27E

Date: 5/23/2018

RECEIVED  
BLM AZ STATE OFFICE  
2018 JUN 25 P 1:02  
PHOENIX, ARIZONA



## EXHIBIT A

County: Graham

State: AZ

<u>BLM Serial #</u>	<u>Claim Name</u>	<u>Original Recording</u>		<u>Amended Recording</u>		<u>Location</u>
		<u>Recording #</u>	<u>Page #</u>	<u>Recording #</u>	<u>Page #</u>	
AMC 431611	ROCKSTAR 211	2015-2591				SEC04-T07S-R27E
AMC 431612	ROCKSTAR 212	2015-2592				SEC04-T07S-R27E
AMC 431613	ROCKSTAR 213	2015-2593				SEC04-T07S-R27E
AMC 431614	ROCKSTAR 214	2015-2594				SEC04-T07S-R27E
AMC 431615	ROCKSTAR 215	2015-2595				SEC04-T07S-R27E
AMC 431616	ROCKSTAR 216	2015-2596				SEC04-T07S-R27E
AMC 431617	ROCKSTAR 217	2015-2597				SEC04-T07S-R27E
AMC 431618	ROCKSTAR 218	2015-2598				SEC04-T07S-R27E
AMC 431619	ROCKSTAR 219	2015-2599				SEC04-T07S-R27E
AMC 431620	ROCKSTAR 220	2015-2600				SEC04-T07S-R27E
AMC 431621	ROCKSTAR 221	2015-2601				SEC04-T07S-R27E
AMC 431622	ROCKSTAR 222	2015-2602				SEC04-T07S-R27E
AMC 431623	ROCKSTAR 223	2015-2603				SEC04-T07S-R27E
AMC 431624	ROCKSTAR 224	2015-2604				SEC04-T07S-R27E
AMC 431625	ROCKSTAR 225	2015-2605				SEC04-T07S-R27E
AMC 431626	ROCKSTAR 226	2015-2606				SEC04-T07S-R27E
AMC 431627	ROCKSTAR 227	2015-2607				SEC04-T07S-R27E
AMC 431628	ROCKSTAR 228	2015-2608				SEC04-T07S-R27E
AMC 431629	ROCKSTAR 229	2015-2609				SEC04-T07S-R27E
AMC 431630	ROCKSTAR 230	2015-2610				SEC04-T07S-R27E
AMC 431631	ROCKSTAR 231	2015-2611				SEC04-T07S-R27E
AMC 431632	ROCKSTAR 232	2015-2612				SEC04-T07S-R27E
AMC 431633	ROCKSTAR 233	2015-2613				SEC04-T07S-R27E
AMC 431634	ROCKSTAR 234	2015-2614				SEC04-T07S-R27E
AMC 431635	ROCKSTAR 235	2015-2615				SEC04-T07S-R27E
AMC 431636	ROCKSTAR 236	2015-2616				SEC04-T07S-R27E
AMC 431637	ROCKSTAR 237	2015-2617				SEC04-T07S-R27E
AMC 431638	ROCKSTAR 238	2015-2618				SEC04-T07S-R27E
AMC 431639	ROCKSTAR 239	2015-2619				SEC04-T07S-R27E
AMC 431640	ROCKSTAR 240	2015-2620				SEC04-T07S-R27E
AMC 431641	ROCKSTAR 241	2015-2621				SEC04-T07S-R27E
AMC 431642	ROCKSTAR 242	2015-2622				SEC04-T07S-R27E
AMC 431643	ROCKSTAR 243	2015-2623				SEC08-T07S-R27E
AMC 431644	ROCKSTAR 244	2015-2624				SEC08-T07S-R27E
AMC 431645	ROCKSTAR 245	2015-2625				SEC08-T07S-R27E
AMC 431646	ROCKSTAR 246	2015-2626				SEC08-T07S-R27E
AMC 431647	ROCKSTAR 247	2015-2627				SEC08-T07S-R27E
AMC 431648	ROCKSTAR 248	2015-2628				SEC08-T07S-R27E

Date: 5/23/2018

PHOENIX, ARIZONA  
 2018 JUN 25 P 1:02  
 RECEIVED  
 BLM AZ STATE OFFICE

## EXHIBIT A

County: Graham

State: AZ

<u>BLM Serial #</u>	<u>Claim Name</u>	<u>Original Recording</u>		<u>Amended Recording</u>		<u>Location</u>
		<u>Recording #</u>	<u>Page #</u>	<u>Recording #</u>	<u>Page #</u>	
AMC 431649	ROCKSTAR 249	2015-2629				SEC08-T07S-R27E
AMC 431650	ROCKSTAR 250	2015-2630				SEC08-T07S-R27E
AMC 431651	ROCKSTAR 251	2015-2631				SEC08-T07S-R27E
AMC 431652	ROCKSTAR 252	2015-2632				SEC08-T07S-R27E
AMC 431653	ROCKSTAR 253	2015-2633				SEC08-T07S-R27E
AMC 431654	ROCKSTAR 254	2015-2634				SEC08-T07S-R27E
AMC 431655	ROCKSTAR 255	2015-2635				SEC08-T07S-R27E
AMC 431656	ROCKSTAR 256	2015-2636				SEC08-T07S-R27E
AMC 431657	ROCKSTAR 257	2015-2637				SEC08-T07S-R27E
AMC 431658	ROCKSTAR 258	2015-2638				SEC08-T07S-R27E
AMC 431659	ROCKSTAR 259	2015-2639				SEC08-T07S-R27E
AMC 431660	ROCKSTAR 260	2015-2640				SEC08-T07S-R27E
AMC 431661	ROCKSTAR 261	2015-2641				SEC08-T07S-R27E
AMC 431662	ROCKSTAR 262	2015-2642				SEC08-T07S-R27E
AMC 431663	ROCKSTAR 263	2015-2643				SEC08-T07S-R27E
AMC 431664	ROCKSTAR 264	2015-2644				SEC08-T07S-R27E
AMC 431665	ROCKSTAR 265	2015-2645				SEC07-T07S-R27E
AMC 431666	ROCKSTAR 266	2015-2646				SEC07-T07S-R27E
AMC 431667	ROCKSTAR 267	2015-2647				SEC07-T07S-R27E
AMC 431668	ROCKSTAR 268	2015-2648				SEC07-T07S-R27E
AMC 431669	ROCKSTAR 269	2015-2649				SEC07-T07S-R27E
AMC 431671	ROCKSTAR 271	2015-2651				SEC07-T07S-R27E
AMC 431672	ROCKSTAR 272	2015-2652				SEC07-T07S-R27E
AMC 431673	ROCKSTAR 273	2015-2653				SEC07-T07S-R27E
AMC 431674	ROCKSTAR 274	2015-2654				SEC07-T07S-R27E
AMC 431675	ROCKSTAR 275	2015-2655				SEC07-T07S-R27E
AMC 431676	ROCKSTAR 276	2015-2656				SEC07-T07S-R27E
AMC 431677	ROCKSTAR 277	2015-2657				SEC07-T07S-R27E
AMC 431678	ROCKSTAR 278	2015-2658				SEC07-T07S-R27E
AMC 431679	ROCKSTAR 279	2015-2659				SEC07-T07S-R27E
AMC 431683	ROCKSTAR 283	2015-2663				SEC07-T07S-R27E
AMC 431791	MONSTER-224	2015-2808				SEC22-T05S-R27E
AMC 431792	MONSTER-225	2015-2809				SEC22-T05S-R27E
AMC 431793	MONSTER-226	2015-2810				SEC22-T05S-R27E
AMC 431794	MONSTER-227	2015-2811				SEC22-T05S-R27E
AMC 431795	MONSTER-228	2015-2812				SEC22-T05S-R27E
AMC 431796	MONSTER-229	2015-2813				SEC22-T05S-R27E
AMC 431797	MONSTER-230	2015-2814				SEC22-T05S-R27E

Date: 5/23/2018

RECEIVED  
BLM AZ STATE OFFICE  
2018 JUN 25 P 1:02  
PHOENIX, ARIZONA

## EXHIBIT A

County: Graham

State: AZ

<u>BLM Serial #</u>	<u>Claim Name</u>	<u>Original Recording</u>		<u>Amended Recording</u>		<u>Location</u>
		<u>Recording #</u>	<u>Page #</u>	<u>Recording #</u>	<u>Page #</u>	
AMC 431798	MONSTER-231	2015-2815				SEC22-T05S-R27E
AMC 431799	MONSTER-232	2015-2816				SEC22-T05S-R27E
AMC 431800	MONSTER-233	2015-2817				SEC22-T05S-R27E
AMC 431801	MONSTER-234	2015-2818				SEC22-T05S-R27E
AMC 431802	MONSTER-235	2015-2819				SEC22-T05S-R27E
AMC 431803	MONSTER-236	2015-2820				SEC22-T05S-R27E
AMC 431804	MONSTER-237	2015-2821				SEC22-T05S-R27E
AMC 431805	MONSTER-238	2015-2822				SEC22-T05S-R27E
AMC 431806	MONSTER-239	2015-2823				SEC22-T05S-R27E
AMC 431807	MONSTER-240	2015-2824				SEC22-T05S-R27E
AMC 431808	MONSTER-241	2015-2825				SEC22-T05S-R27E
AMC 431809	MONSTER-242	2015-2826				SEC22-T05S-R27E
AMC 431810	MONSTER-243	2015-2827				SEC22-T05S-R27E
AMC 431811	MONSTER-244	2015-2828				SEC22-T05S-R27E
AMC 431812	MONSTER-245	2015-2829				SEC22-T05S-R27E
AMC 431813	MONSTER-246	2015-2830				SEC22-T05S-R27E
AMC 431814	MONSTER-247	2015-2831				SEC22-T05S-R27E
AMC 431815	MONSTER-248	2015-2832				SEC22-T05S-R27E
AMC 431816	MONSTER-249	2015-2833				SEC22-T05S-R27E
AMC 431817	MONSTER-250	2015-2834				SEC22-T05S-R27E
AMC 431818	MONSTER-251	2015-2835				SEC22-T05S-R27E
AMC 431819	MONSTER-252	2015-2836				SEC22-T05S-R27E
AMC 431820	MONSTER-253	2015-2837				SEC22-T05S-R27E
AMC 431821	MONSTER-254	2015-2838				SEC22-T05S-R27E
AMC 431822	MONSTER-255	2015-2839				SEC22-T05S-R27E
AMC 431823	MONSTER-256	2015-2840				SEC22-T05S-R27E
AMC 431824	MONSTER-257	2015-2841				SEC22-T05S-R27E
AMC 431825	MONSTER-258	2015-2842				SEC22-T05S-R27E
AMC 431826	MONSTER-259	2015-2843				SEC21-T05S-R27E
AMC 431827	MONSTER-260	2015-2844				SEC21-T05S-R27E
AMC 431828	MONSTER-261	2015-2845				SEC21-T05S-R27E
AMC 431829	MONSTER-262	2015-2846				SEC21-T05S-R27E
AMC 431830	MONSTER-263	2015-2847				SEC21-T05S-R27E
AMC 431831	MONSTER-264	2015-2848				SEC21-T05S-R27E
AMC 431832	MONSTER-265	2015-2849				SEC21-T05S-R27E
AMC 431833	MONSTER-266	2015-2850				SEC21-T05S-R27E
AMC 431834	MONSTER-267	2015-2851				SEC21-T05S-R27E
AMC 431835	MONSTER-268	2015-2852				SEC21-T05S-R27E

Date: 5/23/2018

RECEIVED  
 BLM AZ STATE OFFICE  
 2018 JUN 25 P 1:02  
 PHOENIX, ARIZONA

## EXHIBIT A

County: Graham

State: AZ

<u>BLM Serial #</u>	<u>Claim Name</u>	<u>Original Recording</u>		<u>Amended Recording</u>		<u>Location</u>
		<u>Recording #</u>	<u>Page #</u>	<u>Recording #</u>	<u>Page #</u>	
AMC 431836	MONSTER-269	2015-2853				SEC21-T05S-R27E
AMC 431837	MONSTER-270	2015-2854				SEC21-T05S-R27E
AMC 431838	MONSTER-271	2015-2855				SEC21-T05S-R27E
AMC 431839	MONSTER-272	2015-2856				SEC21-T05S-R27E
AMC 431840	MONSTER-277	2015-2857				SEC21-T05S-R27E
AMC 431841	MONSTER-278	2015-2858				SEC21-T05S-R27E
AMC 431842	MONSTER-279	2015-2859				SEC21-T05S-R27E
AMC 431843	MONSTER-280	2015-2860				SEC21-T05S-R27E
AMC 431844	MONSTER-285	2015-2861				SEC21-T05S-R27E
AMC 431845	MONSTER-286	2015-2862				SEC21-T05S-R27E
AMC 431846	MONSTER-287	2015-2863				SEC21-T05S-R27E
AMC 431847	MONSTER-288	2015-2864				SEC21-T05S-R27E
AMC 431848	MONSTER-293	2015-2865				SEC21-T05S-R27E
AMC 431849	MONSTER-294	2015-2866				SEC21-T05S-R27E
AMC 431850	MONSTER-421	2015-2867				SEC16-T05S-R27E
AMC 431851	MONSTER-422	2015-2868				SEC16-T05S-R27E
AMC 431852	MONSTER-423	2015-2869				SEC16-T05S-R27E
AMC 431853	MONSTER-424	2015-2870				SEC16-T05S-R27E
AMC 431854	MONSTER-425	2015-2871				SEC16-T05S-R27E
AMC 431855	MONSTER-426	2015-2872				SEC16-T05S-R27E
AMC 431856	MONSTER-427	2015-2873				SEC16-T05S-R27E
AMC 431857	MONSTER-428	2015-2874				SEC16-T05S-R27E
AMC 431858	MONSTER-429	2015-2875				SEC16-T05S-R27E
AMC 431859	MONSTER-430	2015-2876				SEC16-T05S-R27E
AMC 431860	MONSTER-431	2015-2877				SEC16-T05S-R27E
AMC 431861	MONSTER-432	2015-2878				SEC16-T05S-R27E
AMC 431862	MONSTER-433	2015-2879				SEC16-T05S-R27E
AMC 431863	MONSTER-434	2015-2880				SEC16-T05S-R27E
AMC 431864	MONSTER-435	2015-2881				SEC16-T05S-R27E
AMC 431865	MONSTER-436	2015-2882				SEC16-T05S-R27E
AMC 431866	MONSTER-437	2015-2883				SEC16-T05S-R27E
AMC 431867	MONSTER-438	2015-2884				SEC16-T05S-R27E
AMC 431868	MONSTER-439	2015-2885				SEC16-T05S-R27E
AMC 431869	MONSTER-440	2015-2886				SEC16-T05S-R27E
AMC 431870	MONSTER-441	2015-2887				SEC16-T05S-R27E
AMC 431871	MONSTER-442	2015-2888				SEC16-T05S-R27E
AMC 431872	MONSTER-443	2015-2889				SEC16-T05S-R27E
AMC 431873	MONSTER-444	2015-2890				SEC16-T05S-R27E

Date: 5/23/2018

RECEIVED  
BLM AZ STATE OFFICE  
2018 JUN 25 P 1:02  
PHOENIX, ARIZONA

## EXHIBIT A

County: Graham

State: AZ

<u>BLM Serial #</u>	<u>Claim Name</u>	<u>Original Recording</u>		<u>Amended Recording</u>		<u>Location</u>
		<u>Recording #</u>	<u>Page #</u>	<u>Recording #</u>	<u>Page #</u>	
AMC 431874	MONSTER-445	2015-2891				SEC16-T05S-R27E
AMC 431875	MONSTER-446	2015-2892				SEC16-T05S-R27E
AMC 431876	MONSTER-447	2015-2893				SEC16-T05S-R27E
AMC 431877	MONSTER-448	2015-2894				SEC16-T05S-R25E
AMC 431878	MONSTER-449	2015-2895				SEC15-T05S-R27E
AMC 431879	MONSTER-450	2015-2896				SEC15-T05S-R27E
AMC 431880	MONSTER-451	2015-2897				SEC15-T05S-R27E
AMC 431881	MONSTER-452	2015-2898				SEC15-T05S-R27E
AMC 431882	MONSTER-453	2015-2899				SEC15-T05S-R27E
AMC 431883	MONSTER-454	2015-2900				SEC15-T05S-R27E
AMC 431884	MONSTER-455	2015-2901				SEC15-T05S-R27E
AMC 431885	MONSTER-456	2015-2902				SEC15-T05S-R27E
AMC 431886	MONSTER-457	2015-2903				SEC15-T05S-R27E
AMC 431887	MONSTER-458	2015-2904				SEC15-T05S-R27E
AMC 431888	MONSTER-459	2015-2905				SEC15-T05S-R27E
AMC 431889	MONSTER-460	2015-2906				SEC15-T05S-R27E
AMC 431890	MONSTER-461	2015-2907				SEC15-T05S-R27E
AMC 431891	MONSTER-462	2015-2908				SEC15-T05S-R27E
AMC 431892	MONSTER-463	2015-2909				SEC15-T05S-R27E
AMC 431893	MONSTER-464	2015-2910				SEC15-T05S-R27E
AMC 431894	MONSTER-465	2015-2911				SEC15-T05S-R27E
AMC 431895	MONSTER-466	2015-2912				SEC15-T05S-R27E
AMC 431896	MONSTER-467	2015-2913				SEC15-T05S-R27E
AMC 431897	MONSTER-468	2015-2914				SEC15-T05S-R27E
AMC 431898	MONSTER-469	2015-2915				SEC15-T05S-R27E
AMC 431899	MONSTER-470	2015-2916				SEC15-T05S-R27E
AMC 431900	MONSTER-471	2015-2917				SEC15-T05S-R27E
AMC 431901	MONSTER-472	2015-2918				SEC15-T05S-R27E
AMC 431902	MONSTER-473	2015-2919				SEC15-T05S-R27E
AMC 431903	MONSTER-474	2015-2920				SEC15-T05S-R27E
AMC 431904	MONSTER-109	2015-2664				SEC27-T05S-R27E
AMC 431905	MONSTER-110	2015-2665				SEC27-T05S-R27E
AMC 431906	MONSTER-111	2015-2666				SEC27-T05S-R27E
AMC 431907	MONSTER-112	2015-2667				SEC27-T05S-R27E
AMC 431908	MONSTER-113	2015-2668				SEC27-T05S-R27E
AMC 431909	MONSTER-114	2015-2669				SEC27-T05S-R27E
AMC 431910	MONSTER-115	2015-2670				SEC27-T05S-R27E
AMC 431911	MONSTER-116	2015-2671				SEC27-T05S-R27E

Date: 5/23/2018

PHOENIX, ARIZONA

2018 JUN 25 P 1:03

RECEIVED  
BLM AZ STATE OFFICE

## EXHIBIT A

County: Graham

State: AZ

<u>BLM Serial #</u>	<u>Claim Name</u>	<u>Original Recording</u>		<u>Amended Recording</u>		<u>Location</u>
		<u>Recording #</u>	<u>Page #</u>	<u>Recording #</u>	<u>Page #</u>	
AMC 431912	MONSTER-117	2015-2672				SEC27-T05S-R27E
AMC 431913	MONSTER-118	2015-2673				SEC27-T05S-R27E
AMC 431914	MONSTER-119	2015-2674				SEC27-T05S-R27E
AMC 431915	MONSTER-120	2015-2675				SEC27-T05S-R27E
AMC 431916	MONSTER-121	2015-2676				SEC27-T05S-R27E
AMC 431917	MONSTER-122	2015-2677				SEC27-T05S-R27E
AMC 431918	MONSTER-123	2015-2678				SEC27-T05S-R27E
AMC 431919	MONSTER-124	2015-2679				SEC27-T05S-R27E
AMC 431920	MONSTER-125	2015-2680				SEC27-T05S-R27E
AMC 431921	MONSTER-126	2015-2681				SEC27-T05S-R27E
AMC 431922	MONSTER-127	2015-2682				SEC27-T05S-R27E
AMC 431923	MONSTER-128	2015-2683				SEC27-T05S-R27E
AMC 431924	MONSTER-129	2015-2684				SEC27-T05S-R27E
AMC 431925	MONSTER-130	2015-2685				SEC27-T05S-R27E
AMC 431926	MONSTER-131	2015-2686				SEC27-T05S-R27E
AMC 431927	MONSTER-132	2015-2687				SEC27-T05S-R27E
AMC 431928	MONSTER-133	2015-2688				SEC27-T05S-R27E
AMC 431929	MONSTER-134	2015-2689				SEC27-T05S-R27E
AMC 431930	MONSTER-135	2015-2690				SEC27-T05S-R27E
AMC 431931	MONSTER-136	2015-2691				SEC27-T05S-R27E
AMC 431932	MONSTER-137	2015-2692				SEC27-T05S-R27E
AMC 431933	MONSTER-138	2015-2693				SEC27-T05S-R27E
AMC 431934	MONSTER-139	2015-2694				SEC27-T05S-R27E
AMC 431935	MONSTER-140	2015-2695				SEC27-T05S-R27E
AMC 431936	MONSTER-141	2015-2696				SEC34-T05S-R27E
AMC 431937	MONSTER-142	2015-2697				SEC34-T05S-R27E
AMC 431938	MONSTER-143	2015-2698				SEC34-T05S-R27E
AMC 431939	MONSTER-144	2015-2699				SEC34-T05S-R27E
AMC 431940	MONSTER-145	2015-2700				SEC34-T05S-R27E
AMC 431941	MONSTER-146	2015-2701				SEC34-T05S-R27E
AMC 431942	MONSTER-147	2015-2702		2016-04041		SEC34-T05S-R27E
AMC 431943	MONSTER-148	2015-2703		2016-04042		SEC34-T05S-R27E
AMC 431944	MONSTER-151	2015-2704		2016-04043		SEC34-T05S-R27E
AMC 431945	MONSTER-152	2015-2705		2016-04044		SEC34-T05S-R27E
AMC 431946	MONSTER-153	2015-2706				SEC34-T05S-R27E
AMC 431947	MONSTER-154	2015-2707				SEC34-T05S-R27E
AMC 431948	MONSTER-155	2015-2708				SEC34-T05S-R27E
AMC 431949	MONSTER-156	2015-2709				SEC34-T05S-R27E

Date: 5/23/2018

PHOENIX, ARIZONA

2018 JUN 25 P 1:03

RECEIVED  
BLM AZ STATE OFFICE

## EXHIBIT A

County: Graham

State: AZ

<u>BLM Serial #</u>	<u>Claim Name</u>	<u>Original Recording</u>		<u>Amended Recording</u>		<u>Location</u>
		<u>Recording #</u>	<u>Page #</u>	<u>Recording #</u>	<u>Page #</u>	
AMC 431950	MONSTER-157	2015-2710				SEC34-T05S-R27E
AMC 431951	MONSTER-158	2015-2711				SEC34-T05S-R27E
AMC 431952	MONSTER-177	2015-2712				SEC35-T05S-R27E
AMC 431953	MONSTER-178	2015-2713				SEC35-T05S-R27E
AMC 431954	MONSTER-179	2015-2714				SEC35-T05S-R27E
AMC 431955	MONSTER-180	2015-2715				SEC35-T05S-R27E
AMC 431956	MONSTER-181	2015-2716				SEC35-T05S-R27E
AMC 431957	MONSTER-182	2015-2717				SEC35-T05S-R27E
AMC 431958	MONSTER-183	2015-2718				SEC35-T05S-R27E
AMC 431959	MONSTER-184	2015-2719				SEC35-T05S-R27E
AMC 431960	MONSTER-185	2015-2720				SEC35-T05S-R27E
AMC 431961	MONSTER-186	2015-2721				SEC35-T05S-R27E
AMC 431962	MONSTER-187	2015-2722				SEC35-T05S-R27E
AMC 431963	MONSTER-188	2015-2723				SEC35-T05S-R27E
AMC 431964	MONSTER-189	2015-2724				SEC35-T05S-R27E
AMC 431965	MONSTER-190	2015-2725				SEC35-T05S-R27E
AMC 431966	MONSTER-191	2015-2726				SEC35-T05S-R27E
AMC 431967	MONSTER-192	2015-2727				SEC35-T05S-R27E
AMC 431968	MONSTER-193	2015-2728				SEC35-T05S-R27E
AMC 431969	MONSTER-194	2015-2729				SEC35-T05S-R27E
AMC 431970	MONSTER-195	2015-2730				SEC35-T05S-R27E
AMC 431971	MONSTER-196	2015-2731				SEC35-T05S-R27E
AMC 431972	MONSTER-197	2015-2732				SEC35-T05S-R27E
AMC 431973	MONSTER-198	2015-2733				SEC35-T05S-R27E
AMC 431974	MONSTER-199	2015-2734				SEC35-T05S-R27E
AMC 431975	MONSTER-200	2015-2735				SEC35-T05S-R27E
AMC 431976	MONSTER-201	2015-2736				SEC35-T05S-R27E
AMC 431977	MONSTER-202	2015-2737				SEC26-T05S-R27E
AMC 431978	MONSTER-203	2015-2738				SEC26-T05S-R27E
AMC 431979	MONSTER-204	2015-2739				SEC26-T05S-R27E
AMC 431980	MONSTER-205	2015-2740				SEC26-T05S-R27E
AMC 431981	MONSTER-206	2015-2741				SEC26-T05S-R27E
AMC 431982	MONSTER-207	2015-2742				SEC26-T05S-R27E
AMC 431983	MONSTER-208	2015-2743				SEC26-T05S-R27E
AMC 431984	MONSTER-209	2015-2744				SEC26-T05S-R27E
AMC 431985	MONSTER-210	2015-2745				SEC26-T05S-R27E
AMC 431986	MONSTER-211	2015-2746				SEC26-T05S-R27E
AMC 431987	MONSTER-212	2015-2747				SEC26-T05S-R27E

Date: 5/23/2018

RECEIVED  
BLM AZ STATE OFFICE  
2018 JUN 25 P 1:03  
PHOENIX, ARIZONA

## EXHIBIT A

County: Graham

State: AZ

BLM Serial #	Claim Name	Original Recording		Amended Recording		Location
		Recording #	Page #	Recording #	Page #	
AMC 431988	MONSTER-213	2015-2748				SEC26-T05S-R27E
AMC 431989	MONSTER-214	2015-2749				SEC26-T05S-R27E
AMC 431990	MONSTER-215	2015-2750				SEC26-T05S-R27E
AMC 431991	MONSTER-216	2015-2751				SEC26-T05S-R27E
AMC 431992	MONSTER-217	2015-2752				SEC26-T05S-R27E
AMC 431993	MONSTER-218	2015-2753				SEC26-T05S-R27E
AMC 431994	MONSTER-219	2015-2754				SEC23-T05S-R27E
AMC 431995	MONSTER-220	2015-2755				SEC23-T05S-R27E
AMC 431996	MONSTER-221	2015-2756				SEC23-T05S-R27E
AMC 431997	MONSTER-222	2015-2757				SEC23-T05S-R27E
AMC 431998	MONSTER-223	2015-2758				SEC23-T05S-R27E
AMC 431999	MONSTER-273	2015-2759				SEC21-T05S-R27E
AMC 432000	MONSTER-274	2015-2760				SEC21-T05S-R27E
AMC 432001	MONSTER-275	2015-2761				SEC21-T05S-R27E
AMC 432002	MONSTER-276	2015-2762				SEC21-T05S-R27E
AMC 432003	MONSTER-281	2015-2763				SEC21-T05S-R27E
AMC 432004	MONSTER-282	2015-2764				SEC21-T05S-R27E
AMC 432005	MONSTER-283	2015-2765				SEC21-T05S-R27E
AMC 432006	MONSTER-284	2015-2766				SEC21-T05S-R27E
AMC 432007	MONSTER-289	2015-2767				SEC21-T05S-R27E
AMC 432008	MONSTER-290	2015-2768				SEC21-T05S-R27E
AMC 432009	MONSTER-291	2015-2769				SEC21-T05S-R27E
AMC 432010	MONSTER-292	2015-2770				SEC21-T05S-R27E
AMC 432011	MONSTER-295	2015-2771				SEC20-T05S-R27E
AMC 432012	MONSTER-296	2015-2772				SEC20-T05S-R27E
AMC 432013	MONSTER-297	2015-2773				SEC20-T05S-R27E
AMC 432014	MONSTER-298	2015-2774				SEC20-T05S-R27E
AMC 432015	MONSTER-299	2015-2775				SEC20-T05S-R27E
AMC 432016	MONSTER-300	2015-2776				SEC20-T05S-R27E
AMC 432017	MONSTER-301	2015-2777				SEC20-T05S-R27E
AMC 432018	MONSTER-302	2015-2778				SEC20-T05S-R27E
AMC 432019	MONSTER-303	2015-2779				SEC20-T05S-R27E
AMC 432020	MONSTER-304	2015-2780				SEC20-T05S-R27E
AMC 432021	MONSTER-305	2015-2781				SEC20-T05S-R27E
AMC 432022	MONSTER-306	2015-2782				SEC20-T05S-R27E
AMC 432023	MONSTER-307	2015-2783				SEC20-T05S-R27E
AMC 432024	MONSTER-308	2015-2784				SEC20-T05S-R27E
AMC 432025	MONSTER-309	2015-2785				SEC20-T05S-R27E

Date: 5/23/2018

Page 61

PHOENIX, ARIZONA

2018 JUN 25 P 1:03

RECEIVED  
BLM AZ STATE OFFICE



## EXHIBIT A

County: Graham

State: AZ

BLM Serial #	Claim Name	Original Recording		Amended Recording		Location
		Recording #	Page #	Recording #	Page #	
AMC 432026	MONSTER-310	2015-2786				SEC20-T05S-R27E
AMC 432027	MONSTER-311	2015-2787				SEC20-T05S-R27E
AMC 432028	MONSTER-312	2015-2789				SEC20-T05S-R27E
AMC 432029	MONSTER-313	2015-2790				SEC20-T05S-R27E
AMC 432030	MONSTER-314	2015-2791				SEC20-T05S-R27E
AMC 432031	MONSTER-315	2015-2792				SEC20-T05S-R27E
AMC 432032	MONSTER-316	2015-2793				SEC20-T05S-R27E
AMC 432033	MONSTER-317	2015-2794				SEC20-T05S-R27E
AMC 432034	MONSTER-318	2015-2795				SEC20-T05S-R27E
AMC 432035	MONSTER-319	2015-2796				SEC20-T05S-R27E
AMC 432036	MONSTER-320	2015-2797				SEC20-T05S-R27E
AMC 432037	MONSTER-321	2015-2798				SEC20-T05S-R27E
AMC 432038	MONSTER-322	2015-2799				SEC20-T05S-R27E
AMC 432039	MONSTER-323	2015-2800				SEC20-T05S-R27E
AMC 432040	MONSTER-324	2015-2801				SEC20-T05S-R27E
AMC 432041	MONSTER-325	2015-2802				SEC20-T05S-R27E
AMC 432042	MONSTER-326	2015-2803				SEC20-T05S-R27E
AMC 432043	MONSTER-327	2015-2804				SEC20-T05S-R27E
AMC 432044	MONSTER-328	2015-2805				SEC20-T05S-R27E
AMC 432045	MONSTER-329	2015-2806				SEC20-T05S-R27E
AMC 432046	MONSTER-330	2015-2807				SEC20-T05S-R27E
AMC 432120	Red Bull-361	2015-3021				SEC14-T05S-R25E
AMC 432121	Red Bull-362	2015-3022				SEC14-T05S-R25E
AMC 432122	Red Bull-363	2015-3023				SEC14-T05S-R25E
AMC 432123	Red Bull-364	2015-3024				SEC14-T05S-R25E
AMC 432124	Red Bull-365	2015-3025				SEC14-T05S-R25E
AMC 432125	Red Bull-366	2015-3026				SEC14-T05S-R25E
AMC 432126	Red Bull-367	2015-3027				SEC14-T05S-R25E
AMC 432127	Red Bull-368	2015-3028				SEC14-T05S-R25E
AMC 432128	Red Bull-369	2015-3029				SEC14-T05S-R25E
AMC 432129	Red Bull-370	2015-3030				SEC14-T05S-R25E
AMC 432130	Red Bull-371	2015-3031				SEC14-T05S-R25E
AMC 432131	Red Bull-372	2015-3032				SEC14-T05S-R25E
AMC 432132	Red Bull-373	2015-3033				SEC14-T05S-R25E
AMC 432133	Red Bull-374	2015-3034				SEC14-T05S-R25E
AMC 432134	Red Bull-375	2015-3035				SEC14-T05S-R25E
AMC 432135	Red Bull-376	2015-3036				SEC14-T06S-R25E
AMC 432136	Red Bull-377	2015-3037				SEC14-T05S-R25E

Date: 5/23/2018

RECEIVED  
BLM AZ STATE OFFICE  
2018 JUN 25 P 1:03  
PHOENIX, ARIZONA

## EXHIBIT A

County: Graham

State: AZ

<u>BLM Serial #</u>	<u>Claim Name</u>	<u>Original Recording</u>		<u>Amended Recording</u>		<u>Location</u>
		<u>Recording #</u>	<u>Page #</u>	<u>Recording #</u>	<u>Page #</u>	
AMC 432137	Red Bull-378	2015-3038				SEC14-T05S-R25E
AMC 432174	Red Bull-485	2015-3075				SEC25-T05S-R26E
AMC 432175	Red Bull-486	2015-3076				SEC25-T05S-R26E
AMC 432176	Red Bull-487	2015-3077				SEC25-T05S-R26E
AMC 432177	Red Bull-488	2015-3078				SEC25-T05S-R26E
AMC 432178	Red Bull-489	2015-3079				SEC25-T05S-R26E
AMC 432179	Red Bull-490	2015-3080				SEC25-T05S-R26E
AMC 432180	Red Bull-491	2015-3081				SEC25-T05S-R26E
AMC 432181	Red Bull-492	2015-3082				SEC25-T05S-R26E
AMC 432182	Red Bull-530	2015-3083				SEC13-T05S-R26E
AMC 432183	Red Bull-531	2015-3084				SEC13-T05S-R26E
AMC 432184	Red Bull-533	2015-3085				SEC13-T05S-R26E
AMC 432185	Red Bull-534	2015-3086				SEC13-T05S-R26E
AMC 432186	Red Bull-536	2015-3087				SEC13-T05S-R26E
AMC 432187	Red Bull-537	2015-3088				SEC13-T05S-R26E
AMC 432188	Red Bull-539	2015-3089				SEC13-T05S-R26E
AMC 432189	Red Bull-540	2015-3090				SEC13-T05S-R26E
AMC 432190	Red Bull-542	2015-3091				SEC13-T05S-R26E
AMC 432191	Red Bull-543	2015-3092				SEC13-T05S-R26E
AMC 432192	Red Bull-545	2015-3093				SEC13-T05S-R26E
AMC 432193	Red Bull-546	2015-3094				SEC13-T05S-R26E
AMC 432194	Red Bull-548	2015-3095				SEC13-T05S-R26E
AMC 432195	Red Bull-549	2015-3096				SEC13-T05S-R26E
AMC 432196	Red Bull-551	2015-3097				SEC13-T05S-R26E
AMC 432197	Red Bull-552	2015-3098				SEC13-T05S-R26E
AMC 432198	Red Bull-554	2015-3099				SEC13-T05S-R26E
AMC 432199	Red Bull-555	2015-3100				SEC12-T05S-R26E
AMC 432200	Red Bull-556	2015-3101				SEC12-T05S-R26E
AMC 432201	Red Bull-557	2015-3102				SEC12-T05S-R26E
AMC 432202	Red Bull-558	2015-3103				SEC12-T05S-R26E
AMC 432203	Red Bull-559	2015-3104				SEC12-T05S-R26E
AMC 432204	Red Bull-560	2015-3105				SEC12-T05S-R26E
AMC 432205	Red Bull-561	2015-3106				SEC12-T05S-R26E
AMC 432206	Red Bull-562	2015-3107				SEC12-T05S-R26E
AMC 432207	Red Bull-563	2015-3108				SEC12-T05S-R26E
AMC 432208	Red Bull-564	2015-3109				SEC12-T05S-R26E
AMC 432209	Red Bull-565	2015-3110				SEC12-T05S-R26E
AMC 432210	Red Bull-566	2015-3111				SEC12-T05S-R26E

Date: 5/23/2018

RECEIVED  
BLM AZ STATE OFFICE  
2018 JUN 25 P 1:03  
PHOENIX, ARIZONA

## EXHIBIT A

County: Graham

State: AZ

<u>BLM Serial #</u>	<u>Claim Name</u>	<u>Original Recording</u>		<u>Amended Recording</u>		<u>Location</u>
		<u>Recording #</u>	<u>Page #</u>	<u>Recording #</u>	<u>Page #</u>	
AMC 432211	Red Bull-567	2015-3112				SEC12-T05S-R26E
AMC 432212	Red Bull-568	2015-3113				SEC12-T05S-R26E
AMC 432213	Red Bull-569	2015-3114				SEC12-T05S-R26E
AMC 432214	Red Bull-570	2015-3115				SEC12-T05S-R26E
AMC 432215	Red Bull-571	2015-3116				SEC12-T05S-R26E
AMC 432216	Red Bull-572	2015-3117				SEC12-T05S-R26E
AMC 432217	Red Bull-573	2015-3118				SEC12-T05S-R26E
AMC 432218	Red Bull-574	2015-3119				SEC12-T05S-R26E
AMC 432219	Red Bull-575	2015-3120				SEC12-T05S-R26E
AMC 432220	Red Bull-576	2015-3121				SEC12-T05S-R26E
AMC 432221	Red Bull-577	2015-3122				SEC12-T05S-R26E
AMC 432222	Red Bull-578	2015-3123				SEC12-T05S-R26E
AMC 432223	Red Bull-579	2015-3124				SEC12-T05S-R26E
AMC 432224	Red Bull-580	2015-3125				SEC12-T05S-R26E
AMC 432225	Red Bull-581	2015-3126				SEC12-T05S-R26E
AMC 432226	Red Bull-582	2015-3127				SEC12-T05S-R26E
AMC 432227	Red Bull-583	2015-3128				SEC12-T05S-R26E
AMC 432228	Red Bull-584	2015-3129				SEC12-T05S-R26E
AMC 432229	Red Bull-585	2015-3130				SEC12-T05S-R26E
AMC 432230	Red Bull-586	2015-3131				SEC12-T05S-R26E
AMC 432231	Red Bull-587	2015-3132				SEC12-T05S-R26E
AMC 432232	Red Bull-588	2015-3133				SEC12-T05S-R26E
AMC 432233	Red Bull-589	2015-3134				SEC12-T05S-R26E
AMC 432234	Red Bull-590	2015-3135				SEC12-T05S-R26E
AMC 432235	Red Bull-591	2015-3136				SEC12-T05S-R26E
AMC 432241	MONSTER-367	2015-3138				SEC18-T05S-R27E
AMC 432242	MONSTER-368	2015-3139				SEC18-T05S-R27E
AMC 432243	MONSTER-369	2015-3140				SEC18-T05S-R27E
AMC 432244	MONSTER-370	2015-3141				SEC18-T05S-R27E
AMC 432245	MONSTER-371	2015-3142				SEC18-T05S-R27E
AMC 432246	MONSTER-372	2015-3143				SEC18-T05S-R27E
AMC 432247	MONSTER-373	2015-3144				SEC18-T05S-R27E
AMC 432248	MONSTER-374	2015-3145				SEC18-T05S-R27E
AMC 432249	MONSTER-375	2015-3146				SEC18-T05S-R27E
AMC 432250	MONSTER-376	2015-3147				SEC18-T05S-R27E
AMC 432251	MONSTER-377	2015-3148				SEC18-T05S-R27E
AMC 432252	MONSTER-378	2015-3149				SEC18-T05S-R27E
AMC 432253	MONSTER-379	2015-3150				SEC18-T05S-R27E

Date: 5/23/2018

PHOENIX, ARIZONA  
 2018 JUN 25 P 1:03

RECEIVED  
 BLM AZ STATE OFFICE

## EXHIBIT A

County: Graham

State: AZ

<u>BLM Serial #</u>	<u>Claim Name</u>	<u>Original Recording</u>		<u>Amended Recording</u>		<u>Location</u>
		<u>Recording #</u>	<u>Page #</u>	<u>Recording #</u>	<u>Page #</u>	
AMC 432254	MONSTER-380	2015-3151				SEC18-T05S-R27E
AMC 432255	MONSTER-381	2015-3152				SEC18-T05S-R27E
AMC 432256	MONSTER-382	2015-3153				SEC18-T05S-R27E
AMC 432257	MONSTER-383	2015-3154				SEC18-T05S-R27E
AMC 432258	MONSTER-384	2015-3155				SEC18-T05S-R27E
AMC 432259	MONSTER-385	2015-3156				SEC18-T05S-R27E
AMC 432260	MONSTER-386	2015-3157				SEC18-T05S-R27E
AMC 432261	MONSTER-387	2015-3158				SEC18-T05S-R27E
AMC 432262	MONSTER-388	2015-3159				SEC18-T05S-R27E
AMC 432263	MONSTER-389	2015-3160				SEC18-T05S-R27E
AMC 432264	MONSTER-390	2015-3161				SEC18-T05S-R27E
AMC 432265	MONSTER-391	2015-3162				SEC18-T05S-R27E
AMC 432266	MONSTER-392	2015-3163				SEC18-T05S-R27E
AMC 432267	MONSTER-393	2015-3164				SEC18-T05S-R27E
AMC 432268	MONSTER-394	2015-3165				SEC17-T05S-R27E
AMC 432269	MONSTER-395	2015-3166				SEC17-T05S-R27E
AMC 432270	MONSTER-396	2015-3167				SEC17-T05S-R27E
AMC 432271	MONSTER-397	2015-3168				SEC17-T05S-R27E
AMC 432272	MONSTER-398	2015-3169				SEC17-T05S-R27E
AMC 432273	MONSTER-399	2015-3170				SEC17-T05S-R27E
AMC 432274	MONSTER-400	2015-3171				SEC17-T05S-R27E
AMC 432275	MONSTER-401	2015-3172				SEC17-T05S-R27E
AMC 432276	MONSTER-402	2015-3173				SEC17-T05S-R27E
AMC 432277	MONSTER-403	2015-3174				SEC17-T05S-R27E
AMC 432278	MONSTER-404	2015-3175				SEC17-T05S-R27E
AMC 432279	MONSTER-405	2015-3176				SEC17-T05S-R27E
AMC 432280	MONSTER-406	2015-3177				SEC17-T05S-R27E
AMC 432281	MONSTER-407	2015-3178				SEC17-T05S-R27E
AMC 432282	MONSTER-408	2015-3179				SEC17-T05S-R27E
AMC 432283	MONSTER-409	2015-3180				SEC17-T05S-R27E
AMC 432284	MONSTER-410	2015-3181				SEC17-T05S-R27E
AMC 432285	MONSTER-411	2015-3182				SEC17-T05S-R27E
AMC 432286	MONSTER-412	2015-3183				SEC17-T05S-R27E
AMC 432287	MONSTER-413	2015-3184				SEC17-T05S-R27E
AMC 432288	MONSTER-414	2015-3185				SEC17-T05S-R27E
AMC 432289	MONSTER-415	2015-3186				SEC17-T05S-R27E
AMC 432290	MONSTER-416	2015-3187				SEC17-T05S-R27E
AMC 432291	MONSTER-417	2015-3188				SEC17-T05S-R27E

Date: 5/23/2018

RECEIVED  
BLM AZ STATE OFFICE  
2018 JUN 25 P 1:03  
PHOENIX, ARIZONA

## EXHIBIT A

County: Graham

State: AZ

<u>BLM Serial #</u>	<u>Claim Name</u>	<u>Original Recording</u>		<u>Amended Recording</u>		<u>Location</u>
		<u>Recording #</u>	<u>Page #</u>	<u>Recording #</u>	<u>Page #</u>	
AMC 432292	MONSTER-418	2015-3189				SEC17-T05S-R27E
AMC 432293	MONSTER-419	2015-3190				SEC17-T05S-R27E
AMC 432294	MONSTER-420	2015-3191				SEC17-T05S-R27E
AMC 432295	MONSTER-475	2015-3182				SEC10-T05S-R27E
AMC 432296	MONSTER-476	2015-3183				SEC10-T05S-R27E
AMC 432297	MONSTER-477	2015-3184				SEC10-T05S-R27E
AMC 432298	MONSTER-478	2015-3185				SEC10-T05S-R27E
AMC 432299	MONSTER-479	2015-3186				SEC10-T05S-R27E
AMC 432300	MONSTER-480	2015-3187				SEC10-T05S-R27E
AMC 432301	MONSTER-481	2015-3188				SEC10-T05S-R27E
AMC 432302	MONSTER-482	2015-3189				SEC10-T05S-R27E
AMC 432303	MONSTER-483	2015-3190				SEC09-T05S-R27E
AMC 432304	MONSTER-484	2015-3191				SEC09-T05S-R27E
AMC 432305	MONSTER-485	2015-3192				SEC09-T05S-R27E
AMC 432306	MONSTER-486	2015-3193				SEC09-T05S-R27E
AMC 432307	MONSTER-487	2015-3194				SEC09-T05S-R27E
AMC 432308	MONSTER-488	2015-3195				SEC09-T05S-R27E
AMC 432309	MONSTER-489	2015-3196				SEC09-T05S-R27E
AMC 432310	MONSTER-490	2015-3197				SEC09-T05S-R27E
AMC 432311	MONSTER-491	2015-3198				SEC09-T05S-R27E
AMC 432312	MONSTER-492	2015-3199				SEC09-T05S-R27E
AMC 432313	MONSTER-493	2015-3200				SEC09-T05S-R27E
AMC 432314	MONSTER-494	2015-3201				SEC09-T05S-R27E
AMC 432315	MONSTER-495	2015-3202				SEC09-T05S-R27E
AMC 432316	MONSTER-496	2015-3203				SEC09-T05S-R27E
AMC 432317	MONSTER-497	2015-3204				SEC09-T05S-R27E
AMC 432318	MONSTER-498	2015-3205				SEC09-T05S-R27E
AMC 432319	MONSTER-499	2015-3206				SEC09-T05S-R27E
AMC 432320	MONSTER-500	2015-3207				SEC09-T05S-R27E
AMC 432321	MONSTER-501	2015-3208				SEC09-T05S-R27E
AMC 432322	MONSTER-502	2015-3209				SEC09-T05S-R27E
AMC 432323	MONSTER-503	2015-3210				SEC09-T05S-R27E
AMC 432324	MONSTER-504	2015-3211				SEC09-T05S-R27E
AMC 432325	MONSTER-505	2015-3212				SEC09-T05S-R27E
AMC 432326	MONSTER-506	2015-3213				SEC09-T05S-R27E
AMC 432327	MONSTER-507	2015-3214				SEC09-T05S-R27E
AMC 432328	MONSTER-508	2015-3215				SEC09-T05S-R27E
AMC 432329	MONSTER-509	2015-3216				SEC09-T05S-R27E

Date: 5/23/2018

RECEIVED  
BLM AZ STATE OFFICE  
PHOENIX, ARIZONA  
2018 JUN 25 P 1:03

## EXHIBIT A

County: Graham

State: AZ

<u>BLM Serial #</u>	<u>Claim Name</u>	<u>Original Recording</u>		<u>Amended Recording</u>		<u>Location</u>
		<u>Recording #</u>	<u>Page #</u>	<u>Recording #</u>	<u>Page #</u>	
AMC 432330 7	MONSTER-510	2015-3217				SEC08-T05S-R27E
AMC 432331	MONSTER-511	2015-3218				SEC08-T05S-R27E
AMC 432332	MONSTER-512	2015-3219				SEC08-T05S-R27E
AMC 432333	MONSTER-513	2015-3220				SEC08-T05S-R27E
AMC 432334	MONSTER-514	2015-3221				SEC08-T05S-R27E
AMC 432335	MONSTER-515	2015-3222				SEC08-T05S-R27E
AMC 432336	MONSTER-516	2015-3223				SEC08-T05S-R27E
AMC 432337	MONSTER-517	2015-3224				SEC08-T05S-R27E
AMC 432338	MONSTER-518	2015-3225				SEC08-T05S-R27E
AMC 432339	MONSTER-519	2015-3226				SEC08-T05S-R27E
AMC 432340	MONSTER-520	2015-3227				SEC08-T05S-R27E
AMC 432341	MONSTER-521	2015-3228				SEC08-T05S-R27E
AMC 432342	MONSTER-522	2015-3229				SEC08-T05S-R27E
AMC 432343	MONSTER-523	2015-3230				SEC08-T05S-R27E
AMC 432344	MONSTER-524	2015-3231				SEC08-T05S-R27E
AMC 432345	MONSTER-525	2015-3232				SEC08-T05S-R27E
AMC 432346	MONSTER-526	2015-3233				SEC08-T05S-R27E
AMC 432347	MONSTER-527	2015-3234				SEC08-T05S-R27E
AMC 432348	MONSTER-528	2015-3235				SEC08-T05S-R27E
AMC 432349	MONSTER-529	2015-3236				SEC08-T05S-R27E
AMC 432350	MONSTER-530	2015-3237				SEC08-T05S-R27E
AMC 432351	MONSTER-531	2015-3238				SEC08-T05S-R27E
AMC 432352	MONSTER-532	2015-3239				SEC08-T05S-R27E
AMC 432353	MONSTER-533	2015-3240				SEC08-T05S-R27E
AMC 432354	MONSTER-534	2015-3241				SEC08-T05S-R27E
AMC 432355	MONSTER-535	2015-3242				SEC08-T05S-R27E
AMC 432356	MONSTER-536	2015-3243				SEC08-T05S-R27E
AMC 432357	MONSTER-537	2015-3244				SEC07-T05S-R27E
AMC 432358	MONSTER-538	2015-3245				SEC07-T05S-R27E
AMC 432359	MONSTER-539	2015-3246				SEC07-T05S-R27E
AMC 432360	MONSTER-540	2015-3247				SEC07-T05S-R27E
AMC 432361	MONSTER-541	2015-3248				SEC07-T05S-R27E
AMC 432362	MONSTER-542	2015-3249				SEC07-T05S-R27E
AMC 432363	MONSTER-543	2015-3250				SEC07-T05S-R27E
AMC 432364	MONSTER-544	2015-3251				SEC07-T05S-R27E
AMC 432365	MONSTER-545	2015-3252				SEC07-T05S-R27E
AMC 432366	MONSTER-546	2015-3253				SEC07-T05S-R27E
AMC 432367	MONSTER-547	2015-3254				SEC07-T05S-R27E

Date: 5/23/2018

RECEIVED  
BLM AZ STATE OFFICE  
2018 JUN 25 P 1:03  
PHOENIX, ARIZONA

## EXHIBIT A

County: Graham

State: AZ

<u>BLM Serial #</u>	<u>Claim Name</u>	<u>Original Recording</u>		<u>Amended Recording</u>		<u>Location</u>
		<u>Recording #</u>	<u>Page #</u>	<u>Recording #</u>	<u>Page #</u>	
AMC 432368	MONSTER-548	2015-3255				SEC07-T05S-R27E
AMC 432369	MONSTER-549	2015-3256				SEC07-T05S-R27E
AMC 432370	MONSTER-550	2015-3257				SEC07-T05S-R27E
AMC 432371	MONSTER-551	2015-3258				SEC07-T05S-R27E
AMC 432372	MONSTER-552	2015-3259				SEC07-T05S-R27E
AMC 432373	MONSTER-553	2015-3260				SEC07-T05S-R27E
AMC 432374	MONSTER-554	2015-3261				SEC07-T05S-R27E
AMC 432375	MONSTER-555	2015-3262				SEC07-T05S-R27E
AMC 432376	MONSTER-556	2015-3263				SEC07-T05S-R27E
AMC 432377	MONSTER-557	2015-3264				SEC07-T05S-R27E
AMC 432378	MONSTER-558	2015-3265				SEC07-T05S-R27E
AMC 432379	MONSTER-559	2015-3266				SEC07-T05S-R27E
AMC 432380	MONSTER-560	2015-3267				SEC07-T05S-R27E
AMC 432381	MONSTER-561	2015-3268				SEC07-T05S-R27E
AMC 432382	MONSTER-562	2015-3269				SEC07-T05S-R27E
AMC 432383	MONSTER-563	2015-3270				SEC07-T05S-R27E
AMC 432384	MONSTER-589	2015-3281				SEC08-T05S-R27E
AMC 432385	MONSTER-590	2015-3282				SEC05-T05S-R27E
AMC 432386	MONSTER-591	2015-3283				SEC04-T05S-R27E
AMC 432387	MONSTER-592	2015-3284				SEC04-T05S-R27E
AMC 432388	MONSTER-593	2015-3285				SEC04-T05S-R27E
AMC 432389	MONSTER-594	2015-3286				SEC04-T05S-R27E
AMC 432390	MONSTER-595	2015-3287				SEC04-T05S-R27E
AMC 432391	MONSTER-596	2015-3288				SEC04-T05S-R27E
AMC 432392	MONSTER-597	2015-3289				SEC04-T05S-R27E
AMC 432393	MONSTER-598	2015-3290				SEC04-T05S-R27E
AMC 432394	MONSTER-599	2015-3291				SEC04-T05S-R27E
AMC 432395	MONSTER-600	2015-3292				SEC04-T05S-R27E
AMC 432396	MONSTER-601	2015-3293				SEC04-T05S-R27E
AMC 432397	MONSTER-602	2015-3294				SEC04-T05S-R27E
AMC 432398	MONSTER-603	2015-3295				SEC04-T05S-R27E
AMC 432399	MONSTER-604	2015-3296				SEC04-T05S-R27E
AMC 432400	MONSTER-605	2015-3297				SEC04-T05S-R27E
AMC 432401	MONSTER-606	2015-3298				SEC04-T05S-R27E
AMC 432402	MONSTER-607	2015-3299				SEC04-T05S-R27E
AMC 432403	MONSTER-608	2015-3300				SEC04-T05S-R27E
AMC 432404	MONSTER-609	2015-3301				SEC04-T05S-R27E
AMC 432405	MONSTER-610	2015-3302				SEC04-T05S-R27E

Date: 5/23/2018

PHOENIX, ARIZONA  
2018 JUN 25 P 1:03  
RECEIVED

RECEIVED  
BLM AZ STATE OFFICE

## EXHIBIT A

County: Graham

State: AZ

BLM Serial #	Claim Name	Original Recording		Amended Recording		Location
		Recording #	Page #	Recording #	Page #	
AMC 432406	MONSTER-611	2015-3303				SEC04-T05S-R27E
AMC 432407	MONSTER-612	2015-3304				SEC04-T05S-R27E
AMC 432408	MONSTER-613	2015-3305				SEC04-T05S-R27E
AMC 432409	MONSTER-614	2015-3306				SEC04-T05S-R27E
AMC 432410	MONSTER-615	2015-3307				SEC04-T05S-R27E
AMC 432411	MONSTER-616	2015-3308				SEC04-T05S-R27E
AMC 432412	MONSTER-617	2015-3309				SEC04-T05S-R27E
AMC 432413	MONSTER-618	2015-3310				SEC04-T05S-R27E
AMC 432414	MONSTER-619	2015-3311				SEC04-T05S-R27E
AMC 432415	MONSTER-620	2015-3312				SEC04-T05S-R27E
AMC 432416	MONSTER-621	2015-3313				SEC04-T05S-R27E
AMC 432417	MONSTER-622	2015-3314				SEC04-T05S-R27E
AMC 432443	MONSTER-564	2015-3476				SEC06-T05S-R27E
AMC 432444	MONSTER-565	2015-3477				SEC06-T05S-R27E
AMC 432445	MONSTER-566	2015-3478				SEC06-T05S-R27E
AMC 432446	MONSTER-567	2015-3479				SEC06-T05S-R27E
AMC 432447	MONSTER-568	2015-3480				SEC06-T05S-R27E
AMC 432448	MONSTER-569	2015-3481				SEC06-T05S-R27E
AMC 432449	MONSTER-570	2015-3482				SEC06-T05S-R27E
AMC 432450	MONSTER-571	2015-3483				SEC06-T05S-R27E
AMC 432451	MONSTER-572	2015-3484				SEC06-T05S-R27E
AMC 432452	MONSTER-573	2015-3485				SEC06-T05S-R27E
AMC 432453	MONSTER-574	2015-3486				SEC06-T05S-R27E
AMC 432454	MONSTER-575	2015-3487				SEC06-T05S-R27E
AMC 432455	MONSTER-576	2015-3488				SEC06-T05S-R27E
AMC 432456	MONSTER-577	2015-3489				SEC06-T05S-R27E
AMC 432457	MONSTER-578	2015-3490				SEC06-T05S-R27E
AMC 432458	MONSTER-579	2015-3491				SEC06-T05S-R27E
AMC 432459	MONSTER-580	2015-3492				SEC06-T05S-R27E
AMC 432460	MONSTER-581	2015-3493				SEC06-T05S-R27E
AMC 432461	MONSTER-582	2015-3494				SEC06-T05S-R27E
AMC 432462	MONSTER-583	2015-3495				SEC06-T05S-R27E
AMC 432463	MONSTER-584	2015-3496				SEC05-T05S-R27E
AMC 432464	MONSTER-585	2015-3497				SEC05-T05S-R27E
AMC 432465	MONSTER-586	2015-3498				SEC08-T05S-R27E
AMC 432466	MONSTER-587	2015-3499				SEC08-T05S-R27E
AMC 432467	MONSTER-588	2015-3500				SEC08-T05S-R27E
AMC 432486	Red Bull-493	2015-3656				SEC24-T05S-R26E

Date: 5/23/2018

PHOENIX, ARIZONA  
2018 JUN 25 P 1:03  
RECEIVED

RECEIVED  
BLM AZ STATE OFFICE



## EXHIBIT A

County: Graham

State: AZ

<u>BLM Serial #</u>	<u>Claim Name</u>	<u>Original Recording</u>		<u>Amended Recording</u>		<u>Location</u>
		<u>Recording #</u>	<u>Page #</u>	<u>Recording #</u>	<u>Page #</u>	
AMC 432487	Red Bull-494	2015-3657				SEC24-T05S-R26E
AMC 432488	Red Bull-495	2015-3658				SEC24-T05S-R26E
AMC 432489	Red Bull-496	2015-3659				SEC24-T05S-R26E
AMC 432490	Red Bull-497	2015-3660				SEC24-T05S-R26E
AMC 432491	Red Bull-498	2015-3661				SEC24-T05S-R26E
AMC 432492	Red Bull-499	2015-3662				SEC24-T05S-R26E
AMC 432493	Red Bull-500	2015-3663				SEC24-T05S-R26E
AMC 432494	Red Bull-501	2015-3664				SEC24-T05S-R26E
AMC 432495	Red Bull-502	2015-3665				SEC24-T05S-R26E
AMC 432496	Red Bull-503	2015-3666				SEC24-T05S-R26E
AMC 432497	Red Bull-504	2015-3667				SEC24-T05S-R26E
AMC 432498	Red Bull-505	2015-3668				SEC24-T05S-R26E
AMC 432499	Red Bull-506	2015-3669				SEC24-T05S-R26E
AMC 432500	Red Bull-507	2015-3670				SEC24-T05S-R26E
AMC 432501	Red Bull-508	2015-3671				SEC24-T05S-R26E
AMC 432502	Red Bull-509	2015-3672				SEC24-T05S-R26E
AMC 432503	Red Bull-510	2015-3673				SEC24-T05S-R26E
AMC 432504	Red Bull-511	2015-3674				SEC24-T05S-R26E
AMC 432505	Red Bull-512	2015-3675				SEC24-T05S-R26E
AMC 432506	Red Bull-513	2015-3676				SEC24-T05S-R26E
AMC 432507	Red Bull-514	2015-3677				SEC24-T05S-R26E
AMC 432508	Red Bull-515	2015-3678				SEC24-T05S-R26E
AMC 432509	Red Bull-516	2015-3679				SEC24-T05S-R26E
AMC 432510	Red Bull-517	2015-3680				SEC24-T05S-R26E
AMC 432511	Red Bull-518	2015-3681				SEC24-T05S-R26E
AMC 432512	Red Bull-519	2015-3682				SEC24-T05S-R26E
AMC 432513	Red Bull-520	2015-3683				SEC24-T05S-R26E
AMC 432514	Red Bull-521	2015-3684				SEC24-T05S-R26E
AMC 432515	Red Bull-522	2015-3685				SEC24-T05S-R26E
AMC 432516	Red Bull-523	2015-3686				SEC24-T05S-R26E
AMC 432517	Red Bull-524	2015-3687				SEC24-T05S-R26E
AMC 432518	Red Bull-525	2015-3688				SEC24-T05S-R26E
AMC 432519	Red Bull-526	2015-3689				SEC24-T05S-R26E
AMC 432520	Red Bull-527	2015-3690				SEC24-T05S-R26E
AMC 432521	Red Bull-528	2015-3691				SEC24-T05S-R26E
AMC 432522	Red Bull-529	2015-3692				SEC13-T05S-R26E
AMC 432523	Red Bull-532	2015-3693				SEC13-T05S-R26E
AMC 432524	Red Bull-535	2015-3694				SEC13-T05S-R26E

Date: 5/23/2018

RECEIVED  
BLM AZ STATE OFFICE  
2018 JUN 25 P 1:03  
PHOENIX, ARIZONA

## EXHIBIT A

County: Graham

State: AZ

<u>BLM Serial #</u>	<u>Claim Name</u>	<u>Original Recording</u>		<u>Amended Recording</u>		<u>Location</u>
		<u>Recording #</u>	<u>Page #</u>	<u>Recording #</u>	<u>Page #</u>	
AMC 432525	Red Bull-538	2015-3695				SEC13-T05S-R26E
AMC 432526	Red Bull-541	2015-3696				SEC13-T05S-R26E
AMC 432527	Red Bull-544	2015-3697				SEC13-T05S-R26E
AMC 432528	Red Bull-547	2015-3698				SEC13-T05S-R26E
AMC 432529	Red Bull-550	2015-3699				SEC13-T05S-R26E
AMC 432530	Red Bull-553	2015-3700				SEC13-T05S-R26E
AMC 432531	Red Bull-592	2015-3701				SEC01-T05S-R26E
AMC 432532	Red Bull-593	2015-3702				SEC01-T05S-R26E
AMC 432533	Red Bull-594	2015-3703				SEC01-T05S-R26E
AMC 432534	Red Bull-595	2015-3704				SEC01-T05S-R26E
AMC 432535	Red Bull-596	2015-3705				SEC01-T05S-R26E
AMC 432536	Red Bull-597	2015-3706				SEC01-T05S-R26E
AMC 432537	Red Bull-598	2015-3707				SEC01-T05S-R26E
AMC 432538	Red Bull-599	2015-3708				SEC01-T05S-R26E
AMC 432539	Red Bull-600	2015-3709				SEC01-T05S-R26E
AMC 432540	Red Bull-601	2015-3710				SEC01-T05S-R26E
AMC 432541	Red Bull-602	2015-3711				SEC01-T05S-R26E
AMC 432542	Red Bull-603	2015-3712				SEC01-T05S-R26E
AMC 432543	Red Bull-604	2015-3713				SEC01-T05S-R26E
AMC 432544	Red Bull-605	2015-3714				SEC23-T05S-R26E
AMC 432545	Red Bull-606	2015-3715				SEC23-T05S-R26E
AMC 432546	Red Bull-607	2015-3716				SEC23-T05S-R26E
AMC 432547	Red Bull-608	2015-3717				SEC23-T05S-R26E
AMC 432548	Red Bull-609	2015-3718				SEC23-T05S-R26E
AMC 432549	Red Bull-610	2015-3719				SEC23-T05S-R26E
AMC 432550	Red Bull-611	2015-3720				SEC23-T05S-R26E
AMC 432551	Red Bull-612	2015-3721				SEC23-T05S-R25E
AMC 432552	Red Bull-613	2015-3722				SEC14-T05S-R26E
AMC 432553	Red Bull-614	2015-3723				SEC14-T05S-R26E
AMC 432554	Red Bull-615	2015-3724				SEC14-T05S-R26E
AMC 432555	Red Bull-616	2015-3725				SEC14-T05S-R26E
AMC 432556	Red Bull-617	2015-3726				SEC14-T05S-R26E
AMC 432557	Red Bull-618	2015-3727				SEC14-T05S-R26E
AMC 432558	Red Bull-619	2015-3728				SEC14-T05S-R26E
AMC 432559	Red Bull-620	2015-3729				SEC14-T05S-R26E
AMC 432560	Red Bull-621	2015-3730				SEC14-T05S-R26E
AMC 432561	Red Bull-622	2015-3731				SEC14-T05S-R26E
AMC 432562	Red Bull-623	2015-3732				SEC14-T05S-R26E

Date: 5/23/2018

RECEIVED  
BLM AZ STATE OFFICE  
2018 JUN 25 P 1:03  
PHOENIX, ARIZONA

## EXHIBIT A

County: Graham

State: AZ

<u>BLM Serial #</u>	<u>Claim Name</u>	<u>Original Recording</u>		<u>Amended Recording</u>		<u>Location</u>
		<u>Recording #</u>	<u>Page #</u>	<u>Recording #</u>	<u>Page #</u>	
AMC 432563	Red Bull-624	2015-3733				SEC14-T05S-R26E
AMC 432564	Red Bull-625	2015-3734				SEC14-T05S-R26E
AMC 432565	Red Bull-626	2015-3735				SEC14-T05S-R26E
AMC 432566	Red Bull-627	2015-3736				SEC14-T05S-R26E
AMC 432567	Red Bull-628	2015-3737				SEC14-T05S-R26E
AMC 432568	Red Bull-629	2015-3738				SEC14-T05S-R26E
AMC 432569	Red Bull-630	2015-3739				SEC14-T05S-R26E
AMC 432570	Red Bull-631	2015-3740				SEC14-T05S-R26E
AMC 432571	Red Bull-632	2015-3741				SEC14-T05S-R26E
AMC 432572	Red Bull-633	2015-3742				SEC14-T05S-R26E
AMC 432573	Red Bull-634	2015-3743				SEC14-T05S-R26E
AMC 432574	Red Bull-635	2015-3744				SEC14-T05S-R26E
AMC 432575	Red Bull-636	2015-3745				SEC14-T05S-R26E
AMC 432576	Red Bull-637	2015-3746				SEC14-T05S-R26E
AMC 432577	Red Bull-638	2015-3747				SEC14-T05S-R26E
AMC 432578	Red Bull-639	2015-3748				SEC14-T05S-R26E
AMC 432579	Red Bull-640	2015-3749				SEC14-T05S-R26E
AMC 432580	Red Bull-641	2015-3750				SEC11-T05S-R26E
AMC 432581	Red Bull-642	2015-3751				SEC11-T05S-R26E
AMC 432582	Red Bull-643	2015-3752				SEC11-T05S-R26E
AMC 432583	Red Bull-644	2015-3753				SEC11-T05S-R26E
AMC 432584	Red Bull-645	2015-3754				SEC11-T05S-R26E
AMC 432585	Red Bull-646	2015-3755				SEC11-T05S-R26E
AMC 432586	Red Bull-647	2015-3756				SEC11-T05S-R26E
AMC 432587	Red Bull-648	2015-3757				SEC11-T05S-R26E
AMC 432588	Red Bull-649	2015-3758				SEC11-T05S-R26E
AMC 432589	Red Bull-650	2015-3759				SEC11-T05S-R26E
AMC 432590	Red Bull-651	2015-3760				SEC11-T05S-R26E
AMC 432591	Red Bull-652	2015-3761				SEC11-T05S-R26E
AMC 432592	Red Bull-653	2015-3762				SEC11-T05S-R26E
AMC 432593	Red Bull-654	2015-3763				SEC11-T05S-R26E
AMC 432594	Red Bull-655	2015-3764				SEC11-T05S-R26E
AMC 432595	Red Bull-656	2015-3765				SEC11-T05S-R26E
AMC 432596	Red Bull-657	2015-3766				SEC11-T05S-R26E
AMC 432597	Red Bull-658	2015-3767				SEC11-T05S-R26E
AMC 432598	Red Bull-659	2015-3768				SEC11-T05S-R26E
AMC 432599	Red Bull-660	2015-3769				SEC11-T05S-R26E
AMC 432600	Red Bull-661	2015-3770				SEC11-T05S-R26E

Date: 5/23/2018

RECEIVED  
 BLM AZ STATE OFFICE  
 2018 JUN 25 P 1:04  
 PHOENIX, ARIZONA

## EXHIBIT A

County: Graham

State: AZ

<u>BLM Serial #</u>	<u>Claim Name</u>	<u>Original Recording</u>		<u>Amended Recording</u>		<u>Location</u>
		<u>Recording #</u>	<u>Page #</u>	<u>Recording #</u>	<u>Page #</u>	
AMC 432601	Red Bull-662	2015-3771				SEC11-T05S-R26E
AMC 432602	Red Bull-663	2015-3772				SEC11-T05S-R26E
AMC 432603	Red Bull-664	2015-3773				SEC11-T05S-R26E
AMC 432604	Red Bull-665	2015-3774				SEC11-T05S-R26E
AMC 432605	Red Bull-666	2015-3775				SEC11-T05S-R26E
AMC 432606	Red Bull-667	2015-3776				SEC11-T05S-R26E
AMC 432607	Red Bull-668	2015-3777				SEC11-T05S-R26E
AMC 432608	Red Bull-669	2015-3778				SEC11-T05S-R26E
AMC 432609	Red Bull-670	2015-3779				SEC11-T05S-R26E
AMC 432610	Red Bull-671	2015-3780				SEC11-T05S-R26E
AMC 432611	Red Bull-672	2015-3781				SEC11-T05S-R26E
AMC 432612	Red Bull-673	2015-3782				SEC11-T05S-R26E
AMC 432613	Red Bull-674	2015-3783				SEC11-T05S-R26E
AMC 432614	Red Bull-675	2015-3784				SEC11-T05S-R26E
AMC 432615	Red Bull-676	2015-3785				SEC11-T05S-R26E
AMC 432616	Red Bull-677	2015-3786				SEC11-T05S-R26E
AMC 432617	Red Bull-678	2015-3787				SEC11-T05S-R26E
AMC 432618	Red Bull-679	2015-3788				SEC11-T05S-R26E
AMC 432619	Red Bull-680	2015-3789				SEC11-T05S-R26E
AMC 432621	ROCKSTAR 284	2015-3867				SEC06-T06S-R27E
AMC 432622	ROCKSTAR 285	2015-3868				SEC06-T06S-R25E
AMC 432623	ROCKSTAR 286	2015-3869				SEC06-T06S-R25E
AMC 432624	ROCKSTAR 287	2015-3870				SEC06-T06S-R25E
AMC 432625	ROCKSTAR 288	2015-3871				SEC06-T06S-R25E
AMC 432626	ROCKSTAR 289	2015-3872				SEC06-T06S-R25E
AMC 432627	ROCKSTAR 290	2015-3873				SEC06-T06S-R25E
AMC 432628	ROCKSTAR 291	2015-3874				SEC06-T06S-R25E
AMC 432629	ROCKSTAR 292	2015-3875				SEC06-T06S-R25E
AMC 432630	ROCKSTAR 293	2015-3876				SEC06-T06S-R25E
AMC 432631	ROCKSTAR 294	2015-3877				SEC06-T06S-R25E
AMC 432632	ROCKSTAR 295	2015-3878				SEC06-T06S-R25E
AMC 432633	ROCKSTAR 296	2015-3879				SEC06-T06S-R25E
AMC 432634	ROCKSTAR 297	2015-3880				SEC06-T06S-R25E
AMC 432635	ROCKSTAR 298	2015-3881				SEC06-T06S-R25E
AMC 432636	ROCKSTAR 299	2015-3882				SEC06-T06S-R25E
AMC 432637	ROCKSTAR 300	2015-3883				SEC06-T06S-R25E
AMC 432638	ROCKSTAR 301	2015-3884				SEC06-T06S-R25E
AMC 432639	ROCKSTAR 302	2015-3885				SEC06-T06S-R25E

Date: 5/23/2018

RECEIVED  
BLM AZ STATE OFFICE  
2018 JUN 25 P 1:04  
PHOENIX, ARIZONA

## EXHIBIT A

County: Graham

State: AZ

<u>BLM Serial #</u>	<u>Claim Name</u>	<u>Original Recording</u>		<u>Amended Recording</u>		<u>Location</u>
		<u>Recording #</u>	<u>Page #</u>	<u>Recording #</u>	<u>Page #</u>	
AMC 432640	ROCKSTAR 303	2015-3886				SEC06-T06S-R25E
AMC 432641	ROCKSTAR 304	2015-3887				SEC06-T06S-R25E
AMC 432642	ROCKSTAR 305	2015-3888				SEC06-T06S-R25E
AMC 432643	ROCKSTAR 306	2015-3889				SEC06-T06S-R25E
AMC 432644	ROCKSTAR 307	2015-3890				SEC06-T06S-R25E
AMC 432645	ROCKSTAR 308	2015-3891				SEC06-T06S-R25E
AMC 432646	ROCKSTAR 309	2015-3892				SEC06-T06S-R25E
AMC 432647	ROCKSTAR 310	2015-3893				SEC06-T06S-R25E
AMC 432648	ROCKSTAR 311	2015-3894				SEC06-T06S-R25E
AMC 432649	ROCKSTAR 312	2015-3895				SEC06-T06S-R25E
AMC 432650	ROCKSTAR 313	2015-3896				SEC06-T06S-R25E
AMC 432651	ROCKSTAR 314	2015-3897				SEC05-T06S-R25E
AMC 432652	ROCKSTAR 315	2015-3898				SEC05-T06S-R25E
AMC 432653	ROCKSTAR 316	2015-3899				SEC05-T06S-R25E
AMC 432654	ROCKSTAR 317	2015-3900				SEC05-T06S-R25E
AMC 432655	ROCKSTAR 318	2015-3901				SEC05-T06S-R25E
AMC 432656	ROCKSTAR 319	2015-3902				SEC05-T06S-R25E
AMC 432657	ROCKSTAR 320	2015-3903				SEC05-T06S-R25E
AMC 432658	ROCKSTAR 321	2015-3904				SEC05-T06S-R25E
AMC 432659	ROCKSTAR 322	2015-3905				SEC05-T06S-R25E
AMC 432660	ROCKSTAR 323	2015-3906				SEC05-T06S-R25E
AMC 432661	ROCKSTAR 324	2015-3907				SEC05-T06S-R25E
AMC 432662	ROCKSTAR 325	2015-3908				SEC05-T06S-R25E
AMC 432663	ROCKSTAR 326	2015-3909				SEC05-T06S-R25E
AMC 432664	ROCKSTAR 327	2015-3910				SEC05-T06S-R25E
AMC 432665	ROCKSTAR 328	2015-3911				SEC05-T06S-R25E
AMC 432666	ROCKSTAR 329	2015-3912				SEC05-T06S-R25E
AMC 432667	ROCKSTAR 330	2015-3913				SEC05-T06S-R25E
AMC 432668	ROCKSTAR 331	2015-3914				SEC05-T06S-R25E
AMC 432669	ROCKSTAR 332	2015-3915				SEC05-T06S-R25E
AMC 432670	ROCKSTAR 333	2015-3916				SEC05-T06S-R25E
AMC 432671	ROCKSTAR 334	2015-3917				SEC05-T06S-R25E
AMC 432672	ROCKSTAR 335	2015-3918				SEC05-T06S-R25E
AMC 432673	ROCKSTAR 336	2015-3919				SEC05-T06S-R25E
AMC 432674	ROCKSTAR 337	2015-3920				SEC05-T06S-R25E
AMC 432675	ROCKSTAR 338	2015-3921				SEC05-T06S-R25E
AMC 432676	ROCKSTAR 339	2015-3922				SEC05-T06S-R25E
AMC 432677	ROCKSTAR 340	2015-3923				SEC05-T06S-R25E

Date: 5/23/2018

PHOENIX, ARIZONA  
 2018 JUN 25 P 1:04

RECEIVED  
 BLM AZ STATE OFFICE

## EXHIBIT A

County: Graham

State: AZ

<u>BLM Serial #</u>	<u>Claim Name</u>	<u>Original Recording</u>		<u>Amended Recording</u>		<u>Location</u>
		<u>Recording #</u>	<u>Page #</u>	<u>Recording #</u>	<u>Page #</u>	
AMC 432678 7	ROCKSTAR 341	2015-3924				SEC05-T06S-R25E
AMC 432679	ROCKSTAR 342	2015-3925				SEC05-T06S-R25E
AMC 432680	ROCKSTAR 343	2015-3926				SEC05-T06S-R25E
AMC 432681	ROCKSTAR 344	2015-3927				SEC05-T06S-R25E
AMC 432682	ROCKSTAR 345	2015-3928				SEC05-T06S-R25E
AMC 432683	ROCKSTAR 346	2015-3929				SEC05-T06S-R25E
AMC 432684	ROCKSTAR 347	2015-3930				SEC05-T06S-R25E
AMC 432685	ROCKSTAR 348	2015-3931				SEC05-T06S-R25E
AMC 432686	ROCKSTAR 349	2015-3932				SEC05-T06S-R25E
AMC 432687	ROCKSTAR 350	2015-3933				SEC04-T06S-R25E
AMC 432688	ROCKSTAR 351	2015-3934				SEC04-T06S-R25E
AMC 432689	ROCKSTAR 352	2015-3935				SEC04-T06S-R25E
AMC 432690	ROCKSTAR 353	2015-3936				SEC04-T06S-R25E
AMC 432691	ROCKSTAR 354	2015-3937				SEC04-T06S-R25E
AMC 432692	ROCKSTAR 355	2015-3938				SEC04-T06S-R25E
AMC 432693	ROCKSTAR 356	2015-3939				SEC04-T06S-R25E
AMC 432694	ROCKSTAR 357	2015-3940				SEC04-T06S-R25E
AMC 432695	ROCKSTAR 358	2015-3941				SEC04-T06S-R25E
AMC 432696	ROCKSTAR 359	2015-3942				SEC04-T06S-R25E
AMC 432697	ROCKSTAR 360	2015-3943				SEC04-T06S-R25E
AMC 432698	ROCKSTAR 361	2015-3944				SEC04-T06S-R25E
AMC 432699	ROCKSTAR 362	2015-3945				SEC04-T06S-R25E
AMC 432700	ROCKSTAR 363	2015-3946				SEC04-T06S-R25E
AMC 432701	ROCKSTAR 364	2015-3947				SEC04-T06S-R25E
AMC 432702	ROCKSTAR 365	2015-3948				SEC04-T06S-R25E
AMC 432703	ROCKSTAR 366	2015-3949				SEC04-T06S-R25E
AMC 432704	ROCKSTAR 367	2015-3950				SEC04-T06S-R25E
AMC 432705	ROCKSTAR 368	2015-3951				SEC03-T06S-R25E
AMC 432706	ROCKSTAR 369	2015-3952				SEC03-T06S-R25E
AMC 432707	ROCKSTAR 370	2015-3953				SEC03-T06S-R25E
AMC 432708	ROCKSTAR 371	2015-3954				SEC03-T06S-R25E
AMC 432709	ROCKSTAR 372	2015-3955				SEC03-T06S-R25E
AMC 432710	ROCKSTAR 373	2015-3956				SEC03-T06S-R25E
AMC 432711	ROCKSTAR 374	2015-3957				SEC03-T06S-R25E
AMC 432712	ROCKSTAR 375	2015-3958				SEC03-T06S-R25E
AMC 432713	ROCKSTAR 376	2015-3959				SEC03-T06S-R25E
AMC 432714	ROCKSTAR 377	2015-3960				SEC03-T06S-R25E
AMC 432715	ROCKSTAR 378	2015-3961				SEC03-T06S-R25E

Date: 5/23/2018

RECEIVED  
BLM AZ STATE OFFICE  
PHOENIX, ARIZONA  
2018 JUN 25 P 1:04

## EXHIBIT A

County: Graham

State: AZ

<u>BLM Serial #</u>	<u>Claim Name</u>	<u>Original Recording</u>		<u>Amended Recording</u>		<u>Location</u>
		<u>Recording #</u>	<u>Page #</u>	<u>Recording #</u>	<u>Page #</u>	
AMC 432716	ROCKSTAR 379	2015-3962				SEC03-T06S-R25E
AMC 432717	ROCKSTAR 380	2015-3963				SEC03-T06S-R25E
AMC 432718	ROCKSTAR 381	2015-3964				SEC03-T06S-R25E
AMC 432719	ROCKSTAR 382	2015-3965				SEC03-T06S-R25E
AMC 432720	ROCKSTAR 383	2015-3966				SEC03-T06S-R25E
AMC 432721	ROCKSTAR 384	2015-3967				SEC03-T06S-R25E
AMC 432722	ROCKSTAR 385	2015-3968				SEC03-T06S-R25E
AMC 432723	ROCKSTAR 386	2015-3969				SEC03-T06S-R25E
AMC 432724	ROCKSTAR 387	2015-3970				SEC03-T06S-R25E
AMC 432725	ROCKSTAR 388	2015-3971				SEC03-T06S-R25E
AMC 432726	ROCKSTAR 389	2015-3972				SEC03-T06S-R25E
AMC 432727	ROCKSTAR 390	2015-3973				SEC03-T06S-R25E
AMC 432728	ROCKSTAR 391	2015-3974				SEC03-T06S-R25E
AMC 432729	ROCKSTAR 392	2015-3975				SEC03-T06S-R25E
AMC 432730	ROCKSTAR 393	2015-3976				SEC03-T06S-R25E
AMC 432731	ROCKSTAR 394	2015-3977				SEC03-T06S-R25E
AMC 432732	ROCKSTAR 395	2015-3978				SEC03-T06S-R25E
AMC 432733	ROCKSTAR 396	2015-3979				SEC03-T06S-R25E
AMC 432734	ROCKSTAR 397	2015-3980				SEC03-T06S-R25E
AMC 432735	ROCKSTAR 398	2015-3981				SEC03-T06S-R25E
AMC 432736	ROCKSTAR 399	2015-3982				SEC03-T06S-R25E
AMC 432737	ROCKSTAR 400	2015-3983				SEC03-T06S-R25E
AMC 432738	ROCKSTAR 401	2015-3984				SEC03-T06S-R25E
AMC 432739	ROCKSTAR 402	2015-3985				SEC03-T06S-R25E
AMC 432740	ROCKSTAR 403	2015-3986				SEC02-T06S-R25E
AMC 432741	ROCKSTAR 404	2015-3987				SEC02-T06S-R25E
AMC 432742	ROCKSTAR 405	2015-3988				SEC02-T06S-R25E
AMC 432743	ROCKSTAR 406	2015-3989				SEC02-T06S-R25E
AMC 432744	ROCKSTAR 407	2015-3990				SEC02-T06S-R25E
AMC 432745	ROCKSTAR 408	2015-3991				SEC02-T06S-R25E
AMC 432746	ROCKSTAR 409	2015-3992				SEC02-T06S-R25E
AMC 432747	ROCKSTAR 410	2015-3993				SEC02-T06S-R25E
AMC 432748	ROCKSTAR 411	2015-3994				SEC02-T06S-R25E
AMC 432749	ROCKSTAR 412	2015-3995				SEC02-T06S-R25E
AMC 432750	ROCKSTAR 413	2015-3996				SEC02-T06S-R25E
AMC 432751	ROCKSTAR 414	2015-3997				SEC02-T06S-R25E
AMC 432752	ROCKSTAR 415	2015-3998				SEC02-T06S-R25E
AMC 432753	ROCKSTAR 416	2015-3999				SEC02-T06S-R25E

Date: 5/23/2018

RECEIVED  
BLM AZ STATE OFFICE  
2018 JUN 25 P 1:04  
PHOENIX, ARIZONA

## EXHIBIT A

County: Graham

State: AZ

<u>BLM Serial #</u>	<u>Claim Name</u>	<u>Original Recording</u>		<u>Amended Recording</u>		<u>Location</u>
		<u>Recording #</u>	<u>Page #</u>	<u>Recording #</u>	<u>Page #</u>	
AMC 432754	ROCKSTAR 417	2015-4000				SEC02-T06S-R25E
AMC 432755	ROCKSTAR 418	2015-4001				SEC02-T06S-R25E
AMC 432756	ROCKSTAR 419	2015-4002				SEC02-T06S-R25E
AMC 432757	ROCKSTAR 420	2015-4003				SEC02-T06S-R25E
AMC 432758	ROCKSTAR 421	2015-4004				SEC02-T06S-R25E
AMC 432759	ROCKSTAR 422	2015-4005				SEC02-T06S-R25E
AMC 432760	ROCKSTAR 423	2015-4006				SEC02-T06S-R25E
AMC 432761	ROCKSTAR 424	2015-4007				SEC02-T06S-R25E
AMC 432762	ROCKSTAR 425	2015-4008				SEC02-T06S-R25E
AMC 432763	ROCKSTAR 426	2015-4009				SEC02-T06S-R25E
AMC 432764	ROCKSTAR 427	2015-4010				SEC02-T06S-R25E
AMC 432765	ROCKSTAR 428	2015-4011				SEC02-T06S-R25E
AMC 432766	ROCKSTAR 429	2015-4012				SEC02-T06S-R25E
AMC 432767	ROCKSTAR 430	2015-4013				SEC02-T06S-R25E
AMC 432768	ROCKSTAR 431	2015-4014				SEC08-T06S-R25E
AMC 432769	ROCKSTAR 432	2015-4015				SEC08-T06S-R25E
AMC 432770	ROCKSTAR 433	2015-4016				SEC08-T06S-R25E
AMC 432771	ROCKSTAR 434	2015-4017				SEC08-T06S-R25E
AMC 432772	ROCKSTAR 435	2015-4018				SEC08-T06S-R25E
AMC 432773	ROCKSTAR 436	2015-4019				SEC08-T06S-R25E
AMC 432774	ROCKSTAR 437	2015-4020				SEC08-T06S-R25E
AMC 432775	ROCKSTAR 438	2015-4021				SEC08-T06S-R25E
AMC 432776	ROCKSTAR 439	2015-4022				SEC08-T06S-R25E
AMC 432777	ROCKSTAR 440	2015-4023				SEC08-T06S-R25E
AMC 432778	ROCKSTAR 441	2015-4024				SEC08-T06S-R25E
AMC 432779	ROCKSTAR 442	2015-4025				SEC08-T06S-R25E
AMC 432780	ROCKSTAR 443	2015-4026				SEC08-T06S-R25E
AMC 432781	ROCKSTAR 444	2015-4027				SEC08-T06S-R25E
AMC 432782	ROCKSTAR 445	2015-4028				SEC08-T06S-R25E
AMC 432783	ROCKSTAR 446	2015-4029				SEC08-T06S-R25E
AMC 432784	ROCKSTAR 447	2015-4030				SEC08-T06S-R25E
AMC 432785	ROCKSTAR 448	2015-4031				SEC08-T06S-R25E
AMC 432786	ROCKSTAR 449	2015-4032				SEC08-T06S-R25E
AMC 432787	ROCKSTAR 450	2015-4033				SEC08-T06S-R25E
AMC 432788	ROCKSTAR 451	2015-4034				SEC08-T06S-R25E
AMC 432789	ROCKSTAR 452	2015-4035				SEC08-T06S-R25E
AMC 432790	ROCKSTAR 453	2015-4036				SEC08-T06S-R25E
AMC 432791	ROCKSTAR 454	2015-4037				SEC09-T06S-R25E

Date: 5/23/2018

RECEIVED  
BLM AZ STATE OFFICE  
2018 JUN 25 P 1:04  
PHOENIX, ARIZONA



## EXHIBIT A

County: Graham

State: AZ

BLM Serial #	Claim Name	Original Recording		Amended Recording		Location
		Recording #	Page #	Recording #	Page #	
AMC 432792	ROCKSTAR 455	2015-4038				SEC09-T06S-R25E
AMC 432793	ROCKSTAR 456	2015-4039				SEC09-T06S-R25E
AMC 432794	ROCKSTAR 457	2015-4040				SEC09-T06S-R25E
AMC 432795	ROCKSTAR 458	2015-4041				SEC09-T06S-R25E
AMC 432796	ROCKSTAR 459	2015-4042				SEC09-T06S-R25E
AMC 432797	ROCKSTAR 460	2015-4043				SEC09-T06S-R25E
AMC 432798	ROCKSTAR 461	2015-4044				SEC09-T06S-R25E
AMC 432799	ROCKSTAR 462	2015-4045				SEC09-T06S-R25E
AMC 432800	ROCKSTAR 463	2015-4046				SEC09-T06S-R25E
AMC 432801	ROCKSTAR 464	2015-4047				SEC09-T06S-R25E
AMC 432802	ROCKSTAR 465	2015-4048				SEC09-T06S-R25E
AMC 432803	ROCKSTAR 466	2015-4049				SEC09-T06S-R25E
AMC 432804	ROCKSTAR 467	2015-4050				SEC09-T06S-R25E
AMC 432805	ROCKSTAR 468	2015-4051				SEC09-T06S-R25E
AMC 432806	ROCKSTAR 469	2015-4052				SEC09-T06S-R25E
AMC 432807	ROCKSTAR 470	2015-4053				SEC09-T06S-R25E
AMC 432808	ROCKSTAR 471	2015-4054				SEC09-T06S-R25E
AMC 432809	ROCKSTAR 472	2015-4055				SEC10-T06S-R25E
AMC 432810	ROCKSTAR 473	2015-4056				SEC10-T06S-R25E
AMC 432811	ROCKSTAR 474	2015-4057				SEC10-T06S-R25E
AMC 432812	ROCKSTAR 475	2015-4058				SEC10-T06S-R25E
AMC 432813	ROCKSTAR 476	2015-4059				SEC10-T06S-R25E
AMC 432814	ROCKSTAR 477	2015-4060				SEC10-T06S-R25E
AMC 432815	ROCKSTAR 478	2015-4061				SEC10-T06S-R25E
AMC 432816	ROCKSTAR 479	2015-4062				SEC10-T06S-R25E
AMC 432817	ROCKSTAR 480	2015-4063				SEC10-T06S-R25E
AMC 432818	ROCKSTAR 481	2015-4064				SEC10-T06S-R25E
AMC 432819	ROCKSTAR 482	2015-4065				SEC10-T06S-R25E
AMC 432820	ROCKSTAR 483	2015-4066				SEC10-T06S-R25E
AMC 432821	ROCKSTAR 484	2015-4067				SEC10-T06S-R25E
AMC 432822	ROCKSTAR 485	2015-4068				SEC10-T06S-R25E
AMC 432823	ROCKSTAR 486	2015-4069				SEC10-T06S-R25E
AMC 432824	ROCKSTAR 487	2015-4070				SEC10-T06S-R25E
AMC 432825	ROCKSTAR 488	2015-4071				SEC10-T06S-R25E
AMC 432826	ROCKSTAR 489	2015-4072				SEC10-T06S-R25E
AMC 432827	ROCKSTAR 490	2015-4073				SEC10-T06S-R25E
AMC 432828	ROCKSTAR 491	2015-4074				SEC10-T06S-R25E
AMC 432829	ROCKSTAR 492	2015-4075				SEC10-T06S-R25E

Date: 5/23/2018

PHOENIX, ARIZONA

2018 JUN 25 P 1:04

RECEIVED  
BLM AZ STATE OFFICE

## EXHIBIT A

County: Graham

State: AZ

<u>BLM Serial #</u>	<u>Claim Name</u>	<u>Original Recording</u>		<u>Amended Recording</u>		<u>Location</u>
		<u>Recording #</u>	<u>Page #</u>	<u>Recording #</u>	<u>Page #</u>	
AMC 432830	ROCKSTAR 493	2015-4076				SEC10-T06S-R25E
AMC 432831	ROCKSTAR 494	2015-4077				SEC10-T06S-R25E
AMC 432832	ROCKSTAR 495	2015-4078				SEC10-T06S-R25E
AMC 432833	ROCKSTAR 496	2015-4079				SEC10-T06S-R25E
AMC 432834	ROCKSTAR 497	2015-4080				SEC10-T06S-R25E
AMC 432835	ROCKSTAR 498	2015-4081				SEC10-T06S-R25E
AMC 432836	ROCKSTAR 499	2015-4082				SEC10-T06S-R25E
AMC 432837	ROCKSTAR 500	2015-4083				SEC10-T06S-R25E
AMC 432838	ROCKSTAR 501	2015-4084				SEC10-T06S-R25E
AMC 432839	ROCKSTAR 502	2015-4085				SEC10-T06S-R25E
AMC 432840	ROCKSTAR 503	2015-4086				SEC10-T06S-R25E
AMC 432841	ROCKSTAR 504	2015-4087				SEC10-T06S-R25E
AMC 432842	ROCKSTAR 505	2015-4088				SEC10-T06S-R25E
AMC 432843	ROCKSTAR 506	2015-4089				SEC10-T06S-R25E
AMC 432844	ROCKSTAR 507	2015-4090				SEC11-T06S-R25E
AMC 432845	ROCKSTAR 508	2015-4091				SEC11-T06S-R25E
AMC 432846	ROCKSTAR 509	2015-4092				SEC11-T06S-R25E
AMC 432847	ROCKSTAR 510	2015-4093				SEC11-T06S-R25E
AMC 432848	ROCKSTAR 511	2015-4094				SEC11-T06S-R25E
AMC 432849	ROCKSTAR 512	2015-4095				SEC11-T06S-R25E
AMC 432850	ROCKSTAR 513	2015-4096				SEC11-T06S-R25E
AMC 432851	ROCKSTAR 514	2015-4097				SEC11-T06S-R25E
AMC 432852	ROCKSTAR 515	2015-4098				SEC11-T06S-R25E
AMC 432853	ROCKSTAR 516	2015-4099				SEC11-T06S-R25E
AMC 432854	ROCKSTAR 517	2015-4100				SEC11-T06S-R25E
AMC 432855	ROCKSTAR 518	2015-4101				SEC11-T06S-R25E
AMC 432856	ROCKSTAR 519	2015-4102				SEC11-T06S-R25E
AMC 432857	ROCKSTAR 520	2015-4103				SEC11-T06S-R25E
AMC 432858	ROCKSTAR 521	2015-4104				SEC11-T06S-R25E
AMC 432859	ROCKSTAR 522	2015-4105				SEC11-T06S-R25E
AMC 432860	ROCKSTAR 523	2015-4106				SEC11-T06S-R25E
AMC 432861	ROCKSTAR 524	2015-4107				SEC11-T06S-R25E
AMC 432862	ROCKSTAR 525	2015-4108				SEC11-T06S-R25E
AMC 432863	ROCKSTAR 526	2015-4109				SEC11-T06S-R25E
AMC 432864	ROCKSTAR 527	2015-4110				SEC11-T06S-R25E
AMC 432865	ROCKSTAR 528	2015-4111				SEC11-T06S-R25E
AMC 432866	ROCKSTAR 529	2015-4112				SEC11-T06S-R25E
AMC 432867	ROCKSTAR 530	2015-4113				SEC11-T06S-R25E

Date: 5/23/2018

RECEIVED  
BLM AZ STATE OFFICE  
2018 JUN 25 P 1:00  
PHOENIX, ARIZONA

## EXHIBIT A

County: Graham

State: AZ

<u>BLM Serial #</u>	<u>Claim Name</u>	<u>Original Recording</u>		<u>Amended Recording</u>		<u>Location</u>
		<u>Recording #</u>	<u>Page #</u>	<u>Recording #</u>	<u>Page #</u>	
AMC 432868	ROCKSTAR 531	2015-4114				SEC11-T06S-R25E
AMC 432869	ROCKSTAR 532	2015-4115				SEC11-T06S-R25E
AMC 432870	ROCKSTAR 533	2015-4116				SEC11-T06S-R25E
AMC 432871	ROCKSTAR 534	2015-4117				SEC15-T06S-R25E
AMC 432872	ROCKSTAR 535	2015-4118				SEC15-T06S-R25E
AMC 432873	ROCKSTAR 536	2015-4119				SEC15-T06S-R25E
AMC 432874	ROCKSTAR 537	2015-4120				SEC15-T06S-R25E
AMC 432875	ROCKSTAR 538	2015-4121				SEC15-T06S-R25E
AMC 432876	ROCKSTAR 539	2015-4122				SEC15-T06S-R25E
AMC 432877	ROCKSTAR 540	2015-4123				SEC15-T06S-R25E
AMC 432878	ROCKSTAR 541	2015-4124				SEC15-T06S-R25E
AMC 432879	ROCKSTAR 542	2015-4125				SEC15-T06S-R25E
AMC 432880	ROCKSTAR 543	2015-4126				SEC15-T06S-R25E
AMC 432881	ROCKSTAR 544	2015-4127				SEC15-T06S-R25E
AMC 432882	ROCKSTAR 545	2015-4128				SEC15-T06S-R25E
AMC 432883	ROCKSTAR 546	2015-4129				SEC15-T06S-R25E
AMC 432884	ROCKSTAR 547	2015-4130				SEC15-T06S-R25E
AMC 432885	ROCKSTAR 548	2015-4131				SEC15-T06S-R25E
AMC 432886	ROCKSTAR 549	2015-4132				SEC15-T06S-R25E
AMC 432887	ROCKSTAR 550	2015-4133				SEC15-T06S-R25E
AMC 432888	ROCKSTAR 551	2015-4134				SEC15-T06S-R25E
AMC 432889	ROCKSTAR 552	2015-4135				SEC15-T06S-R25E
AMC 432890	ROCKSTAR 553	2015-4136				SEC15-T06S-R25E
AMC 432891	ROCKSTAR 554	2015-4137				SEC15-T06S-R25E
AMC 432892	ROCKSTAR 555	2015-4138				SEC15-T06S-R25E
AMC 432893	ROCKSTAR 556	2015-4139				SEC15-T06S-R25E
AMC 432894	ROCKSTAR 557	2015-4140				SEC15-T06S-R25E
AMC 432895	ROCKSTAR 558	2015-4141				SEC15-T06S-R25E
AMC 432896	ROCKSTAR 559	2015-4142				SEC15-T06S-R25E
AMC 432897	ROCKSTAR 560	2015-4143				SEC15-T06S-R25E
AMC 432898	ROCKSTAR 561	2015-4144				SEC15-T06S-R25E
AMC 432899	ROCKSTAR 562	2015-4145				SEC15-T06S-R25E
AMC 432900	ROCKSTAR 563	2015-4146				SEC15-T06S-R25E
AMC 432901	ROCKSTAR 564	2015-4147				SEC14-T06S-R25E
AMC 432902	ROCKSTAR 565	2015-4148				SEC14-T06S-R25E
AMC 432903	ROCKSTAR 566	2015-4149				SEC14-T06S-R25E
AMC 432904	ROCKSTAR 567	2015-4150				SEC14-T06S-R25E
AMC 432905	ROCKSTAR 568	2015-4151				SEC14-T06S-R25E

Date: 5/23/2018

PHOENIX, ARIZONA  
2018 JUN 25 P 1:04  
RECEIVED

RECEIVED  
BLM AZ STATE OFFICE  
Page 80

## EXHIBIT A

County: Graham

State: AZ

BLM Serial #	Claim Name	Original Recording		Amended Recording		Location
		Recording #	Page #	Recording #	Page #	
AMC 432906 7	ROCKSTAR 569	2015-4152				SEC14-T06S-R25E
AMC 432907	ROCKSTAR 570	2015-4153				SEC14-T06S-R25E
AMC 432908	ROCKSTAR 571	2015-4154				SEC14-T06S-R25E
AMC 432909	ROCKSTAR 572	2015-4155				SEC14-T06S-R25E
AMC 432910	ROCKSTAR 573	2015-4156				SEC14-T06S-R25E
AMC 432911	ROCKSTAR 574	2015-4157				SEC14-T06S-R25E
AMC 432912	ROCKSTAR 575	2015-4158				SEC14-T06S-R25E
AMC 432913	ROCKSTAR 576	2015-4159				SEC14-T06S-R25E
AMC 432914	ROCKSTAR 577	2015-4160				SEC14-T06S-R25E
AMC 432915	ROCKSTAR 578	2015-4161				SEC14-T06S-R25E
AMC 432916	ROCKSTAR 579	2015-4162				SEC14-T06S-R25E
AMC 432917	ROCKSTAR 580	2015-4163				SEC14-T06S-R25E
AMC 432918	ROCKSTAR 581	2015-4164				SEC14-T06S-R25E
AMC 432919	ROCKSTAR 582	2015-4165				SEC14-T06S-R25E
AMC 432920	ROCKSTAR 583	2015-4166				SEC14-T06S-R25E
AMC 432921	ROCKSTAR 584	2015-4167				SEC14-T06S-R25E
AMC 432922	ROCKSTAR 585	2015-4168				SEC14-T06S-R25E
AMC 432923	ROCKSTAR 586	2015-4169				SEC14-T06S-R25E
AMC 432924	ROCKSTAR 587	2015-4170				SEC14-T06S-R25E
AMC 432925	ROCKSTAR 588	2015-4171				SEC14-T06S-R25E
AMC 432926	ROCKSTAR 589	2015-4172				SEC14-T06S-R25E
AMC 432927	ROCKSTAR 590	2015-4173				SEC14-T06S-R25E
AMC 432928	ROCKSTAR 591	2015-4174				SEC14-T06S-R25E
AMC 432929	ROCKSTAR 592	2015-4175				SEC14-T06S-R25E
AMC 432930	ROCKSTAR 593	2015-4176				SEC14-T06S-R25E
AMC 432931 J	ROCKSTAR 594	2015-4177				SEC14-T06S-R25E
AMC 432994 T	ROCKSTAR 595	2015-4259				SEC13-T06S-R25E
AMC 432995	ROCKSTAR 596	2015-4260				SEC13-T06S-R25E
AMC 432996	ROCKSTAR 597	2015-4261				SEC13-T06S-R25E
AMC 432997	ROCKSTAR 598	2015-4262				SEC13-T06S-R25E
AMC 432998	ROCKSTAR 599	2015-4263				SEC13-T06S-R25E
AMC 432999	ROCKSTAR 600	2015-4264				SEC13-T06S-R25E
AMC 433000	ROCKSTAR 601	2015-4265				SEC13-T06S-R25E
AMC 433001	ROCKSTAR 602	2015-4266				SEC13-T06S-R25E
AMC 433002	ROCKSTAR 603	2015-4267				SEC13-T06S-R25E
AMC 433003	ROCKSTAR 604	2015-4268				SEC13-T06S-R25E
AMC 433004	ROCKSTAR 605	2015-4269				SEC13-T06S-R25E
AMC 433005 J	ROCKSTAR 606	2015-4270				SEC13-T06S-R25E

Date: 5/23/2018

RECEIVED  
BLM AZ STATE OFFICE  
2018 JUN 25 P 1:04  
PHOENIX, ARIZONA

## EXHIBIT A

County: Graham

State: AZ

<u>BLM Serial #</u>	<u>Claim Name</u>	<u>Original Recording</u>		<u>Amended Recording</u>		<u>Location</u>
		<u>Recording #</u>	<u>Page #</u>	<u>Recording #</u>	<u>Page #</u>	
AMC 433006	ROCKSTAR 607	2015-4271				SEC13-T06S-R25E
AMC 433007	ROCKSTAR 608	2015-4272				SEC13-T06S-R25E
AMC 433008	ROCKSTAR 609	2015-4273				SEC13-T06S-R25E
AMC 433009	ROCKSTAR 610	2015-4274				SEC13-T06S-R25E
AMC 433010	ROCKSTAR 611	2015-4275				SEC13-T06S-R25E
AMC 433011	ROCKSTAR 612	2015-4276				SEC13-T06S-R25E
AMC 433012	ROCKSTAR 613	2015-4277				SEC13-T06S-R25E
AMC 433013	ROCKSTAR 614	2015-4278				SEC13-T06S-R25E
AMC 433014	ROCKSTAR 615	2015-4279				SEC23-T06S-R25E
AMC 433015	ROCKSTAR 616	2015-4280				SEC23-T06S-R25E
AMC 433016	ROCKSTAR 617	2015-4281				SEC23-T06S-R25E
AMC 433017	ROCKSTAR 618	2015-4282				SEC23-T06S-R25E
AMC 433018	ROCKSTAR 619	2015-4283				SEC23-T06S-R25E
AMC 433019	ROCKSTAR 620	2015-4284				SEC23-T06S-R25E
AMC 433020	ROCKSTAR 621	2015-4285				SEC23-T06S-R25E
AMC 433021	ROCKSTAR 622	2015-4286				SEC23-T06S-R25E
AMC 433022	ROCKSTAR 623	2015-4287				SEC23-T06S-R25E
AMC 433023	ROCKSTAR 624	2015-4288				SEC23-T06S-R25E
AMC 433024	ROCKSTAR 625	2015-4289				SEC23-T06S-R25E
AMC 433025	ROCKSTAR 626	2015-4290				SEC23-T06S-R25E
AMC 433026	ROCKSTAR 627	2015-4291				SEC23-T06S-R25E
AMC 433027	ROCKSTAR 628	2015-4292				SEC23-T06S-R25E
AMC 433028	ROCKSTAR 629	2015-4293				SEC23-T06S-R25E
AMC 433029	ROCKSTAR 630	2015-4294				SEC23-T06S-R25E
AMC 433030	ROCKSTAR 631	2015-4295				SEC23-T06S-R25E
AMC 433031	ROCKSTAR 632	2015-4296				SEC23-T06S-R25E
AMC 433032	ROCKSTAR 633	2015-4297				SEC23-T06S-R25E
AMC 433033	ROCKSTAR 634	2015-4298				SEC23-T06S-R25E
AMC 433034	ROCKSTAR 635	2015-4299				SEC23-T06S-R25E
AMC 433035	ROCKSTAR 636	2015-4300				SEC23-T06S-R25E
AMC 433036	ROCKSTAR 637	2015-4301				SEC23-T06S-R25E
AMC 433037	ROCKSTAR 638	2015-4302				SEC23-T06S-R25E
AMC 433038	ROCKSTAR 639	2015-4303				SEC23-T06S-R25E
AMC 433039	ROCKSTAR 640	2015-4304				SEC23-T06S-R25E
AMC 433040	ROCKSTAR 641	2015-4305				SEC23-T06S-R25E
AMC 433041	ROCKSTAR 642	2015-4306				SEC23-T06S-R25E
AMC 433042	ROCKSTAR 643	2015-4307				SEC23-T06S-R25E
AMC 433043	ROCKSTAR 644	2015-4308				SEC23-T06S-R25E

Date: 5/23/2018

PHOENIX, ARIZONA

2018 JUN 25 P 1:04

RECEIVED  
BLM AZ STATE OFFICE

## EXHIBIT A

County: Graham

State: AZ

<u>BLM Serial #</u>	<u>Claim Name</u>	<u>Original Recording</u>		<u>Amended Recording</u>		<u>Location</u>
		<u>Recording #</u>	<u>Page #</u>	<u>Recording #</u>	<u>Page #</u>	
AMC 433044	ROCKSTAR 645	2015-4309				SEC23-T06S-R25E
AMC 433045	ROCKSTAR 646	2015-4310				SEC23-T06S-R25E
AMC 433046	ROCKSTAR 647	2015-4311				SEC24-T06S-R25E
AMC 433047	ROCKSTAR 648	2015-4312				SEC24-T06S-R25E
AMC 433048	ROCKSTAR 649	2015-4313				SEC24-T06S-R25E
AMC 433049	ROCKSTAR 650	2015-4314				SEC24-T06S-R25E
AMC 433050	ROCKSTAR 651	2015-4315				SEC24-T06S-R25E
AMC 433051	ROCKSTAR 652	2015-4316				SEC24-T06S-R25E
AMC 433052	ROCKSTAR 653	2015-4317				SEC24-T06S-R25E
AMC 433053	ROCKSTAR 654	2015-4318				SEC24-T06S-R25E
AMC 433054	ROCKSTAR 655	2015-4319				SEC24-T06S-R25E
AMC 433055	ROCKSTAR 656	2015-4320				SEC24-T06S-R25E
AMC 433056	ROCKSTAR 657	2015-4321				SEC24-T06S-R25E
AMC 433057	ROCKSTAR 658	2015-4322				SEC24-T06S-R25E
AMC 433058	ROCKSTAR 659	2015-4323				SEC24-T06S-R25E
AMC 433059	ROCKSTAR 660	2015-4324				SEC24-T06S-R25E
AMC 433060	ROCKSTAR 661	2015-4325				SEC24-T06S-R25E
AMC 433061	ROCKSTAR 662	2015-4326				SEC24-T06S-R25E
AMC 433062	ROCKSTAR 663	2015-4327				SEC24-T06S-R25E
AMC 433063	ROCKSTAR 664	2015-4328				SEC24-T06S-R25E
AMC 433064	ROCKSTAR 665	2015-4329				SEC24-T06S-R25E
AMC 433065	ROCKSTAR 666	2015-4330				SEC24-T06S-R25E
AMC 433066	ROCKSTAR 667	2015-4331				SEC24-T06S-R25E
AMC 433067	ROCKSTAR 668	2015-4332				SEC24-T06S-R25E
AMC 433068	ROCKSTAR 669	2015-4333				SEC24-T06S-R25E
AMC 433069	ROCKSTAR 670	2015-4334				SEC24-T06S-R25E
AMC 433070	ROCKSTAR 671	2015-4335				SEC24-T06S-R25E
AMC 433071	ROCKSTAR 672	2015-4336				SEC24-T06S-R25E
AMC 433072	ROCKSTAR 673	2015-4337				SEC24-T06S-R25E
AMC 433073	ROCKSTAR 674	2015-4338				SEC24-T06S-R25E
AMC 433074	ROCKSTAR 675	2015-4339				SEC24-T06S-R25E
AMC 433075	ROCKSTAR 676	2015-4340				SEC24-T06S-R25E
AMC 433076	ROCKSTAR 677	2015-4341				SEC24-T06S-R25E
AMC 433077	ROCKSTAR 678	2015-4342				SEC24-T06S-R25E
AMC 433078	ROCKSTAR 679	2015-4343				SEC24-T06S-R25E
AMC 433079	ROCKSTAR 680	2015-4344				SEC24-T06S-R25E
AMC 433080	ROCKSTAR 681	2015-4345				SEC24-T06S-R25E
AMC 433081	ROCKSTAR 682	2015-4346				SEC24-T06S-R25E

Date: 5/23/2018

RECEIVED  
 BLM AZ STATE OFFICE  
 2018 JUN 25 P 1:04  
 PHOENIX, ARIZONA

## EXHIBIT A

County: Graham

State: AZ

<u>BLM Serial #</u>	<u>Claim Name</u>	<u>Original Recording</u>		<u>Amended Recording</u>		<u>Location</u>
		<u>Recording #</u>	<u>Page #</u>	<u>Recording #</u>	<u>Page #</u>	
AMC 433082	ROCKSTAR 683	2015-4347				SEC25-T06S-R25E
AMC 433083	ROCKSTAR 684	2015-4348				SEC25-T06S-R25E
AMC 433084	ROCKSTAR 685	2015-4349				SEC25-T06S-R25E
AMC 433085	ROCKSTAR 686	2015-4350				SEC25-T06S-R25E
AMC 433086	ROCKSTAR 687	2015-4351				SEC25-T06S-R25E
AMC 433087	ROCKSTAR 688	2015-4352				SEC25-T06S-R25E
AMC 433088	ROCKSTAR 689	2015-4353				SEC25-T06S-R25E
AMC 433089	ROCKSTAR 690	2015-4354				SEC25-T06S-R25E
AMC 433090	ROCKSTAR 691	2015-4355				SEC25-T06S-R25E
AMC 433091	ROCKSTAR 692	2015-4356				SEC25-T06S-R25E
AMC 433092	ROCKSTAR 693	2015-4357				SEC25-T06S-R25E
AMC 433093	ROCKSTAR 694	2015-4358				SEC25-T06S-R25E
AMC 433094	ROCKSTAR 695	2015-4359				SEC25-T06S-R25E
AMC 433095	ROCKSTAR 696	2015-4360				SEC25-T06S-R25E
AMC 433096	ROCKSTAR 697	2015-4361				SEC25-T06S-R25E
AMC 433097	ROCKSTAR 698	2015-4362				SEC25-T06S-R25E
AMC 433098	ROCKSTAR 699	2015-4363				SEC25-T06S-R25E
AMC 433099	ROCKSTAR 700	2015-4364				SEC25-T06S-R25E
AMC 433100	ROCKSTAR 701	2015-4365				SEC25-T06S-R25E
AMC 433101	ROCKSTAR 702	2015-4366				SEC25-T06S-R25E
AMC 433102	ROCKSTAR 703	2015-4367				SEC25-T06S-R25E
AMC 433103	ROCKSTAR 704	2015-4368				SEC25-T06S-R25E
AMC 433104	ROCKSTAR 705	2015-4369				SEC25-T06S-R25E
AMC 433105	ROCKSTAR 706	2015-4370				SEC25-T06S-R25E
AMC 433106	ROCKSTAR 707	2015-4371				SEC25-T06S-R25E
AMC 433107	ROCKSTAR 708	2015-4372				SEC25-T06S-R25E
AMC 433108	ROCKSTAR 709	2015-4373				SEC25-T06S-R25E
AMC 433109	ROCKSTAR 710	2015-4374				SEC18-T06S-R26E
AMC 433110	ROCKSTAR 711	2015-4375				SEC18-T06S-R26E
AMC 433111	ROCKSTAR 712	2015-4376				SEC18-T06S-R26E
AMC 433112	ROCKSTAR 713	2015-4377				SEC18-T06S-R26E
AMC 433113	ROCKSTAR 714	2015-4378				SEC18-T06S-R26E
AMC 433114	ROCKSTAR 715	2015-4379				SEC18-T06S-R26E
AMC 433115	ROCKSTAR 716	2015-4380				SEC18-T06S-R26E
AMC 433116	ROCKSTAR 717	2015-4381				SEC18-T06S-R26E
AMC 433117	ROCKSTAR 718	2015-4382				SEC18-T06S-R26E
AMC 433118	ROCKSTAR 719	2015-4383				SEC18-T06S-R26E
AMC 433119	ROCKSTAR 720	2015-4384				SEC18-T06S-R26E

Date: 5/23/2018

PHOENIX, ARIZONA  
2018 JUN 25 P 1:04

RECEIVED  
BLM AZ STATE OFFICE

## EXHIBIT A

County: Graham

State: AZ

<u>BLM Serial #</u>	<u>Claim Name</u>	<u>Original Recording</u>		<u>Amended Recording</u>		<u>Location</u>
		<u>Recording #</u>	<u>Page #</u>	<u>Recording #</u>	<u>Page #</u>	
AMC 433120	ROCKSTAR 721	2015-4385				SEC18-T06S-R26E
AMC 433121	ROCKSTAR 722	2015-4386				SEC18-T06S-R26E
AMC 433122	ROCKSTAR 723	2015-4387				SEC18-T06S-R26E
AMC 433123	ROCKSTAR 724	2015-4388				SEC18-T06S-R26E
AMC 433124	ROCKSTAR 725	2015-4389				SEC18-T06S-R26E
AMC 433125	ROCKSTAR 726	2015-4390				SEC18-T06S-R26E
AMC 433126	ROCKSTAR 727	2015-4391				SEC19-T06S-R26E
AMC 433127	ROCKSTAR 728	2015-4392				SEC19-T06S-R26E
AMC 433128	ROCKSTAR 729	2015-4393				SEC19-T06S-R26E
AMC 433129	ROCKSTAR 730	2015-4394				SEC19-T06S-R26E
AMC 433130	ROCKSTAR 731	2015-4395				SEC19-T06S-R26E
AMC 433131	ROCKSTAR 732	2015-4396				SEC19-T06S-R26E
AMC 433132	ROCKSTAR 733	2015-4397				SEC19-T06S-R26E
AMC 433133	ROCKSTAR 734	2015-4398				SEC19-T06S-R26E
AMC 433134	ROCKSTAR 735	2015-4399				SEC19-T06S-R26E
AMC 433135	ROCKSTAR 736	2015-4400				SEC19-T06S-R26E
AMC 433136	ROCKSTAR 737	2015-4401				SEC19-T06S-R26E
AMC 433137	ROCKSTAR 738	2015-4402				SEC19-T06S-R26E
AMC 433138	ROCKSTAR 739	2015-4403				SEC19-T06S-R26E
AMC 433139	ROCKSTAR 740	2015-4404				SEC19-T06S-R26E
AMC 433140	ROCKSTAR 741	2015-4405				SEC19-T06S-R26E
AMC 433141	ROCKSTAR 742	2015-4406				SEC19-T06S-R26E
AMC 433142	ROCKSTAR 743	2015-4407				SEC19-T06S-R26E
AMC 433143	ROCKSTAR 744	2015-4408				SEC19-T06S-R26E
AMC 433144	ROCKSTAR 745	2015-4409				SEC19-T06S-R26E
AMC 433145	ROCKSTAR 746	2015-4410				SEC19-T06S-R26E
AMC 433146	ROCKSTAR 747	2015-4411				SEC19-T06S-R26E
AMC 433147	ROCKSTAR 748	2015-4412				SEC19-T06S-R26E
AMC 433148	ROCKSTAR 749	2015-4413				SEC19-T06S-R26E
AMC 433149	ROCKSTAR 750	2015-4414				SEC19-T06S-R26E
AMC 433150	ROCKSTAR 751	2015-4415				SEC19-T06S-R26E
AMC 433151	ROCKSTAR 752	2015-4416				SEC19-T06S-R26E
AMC 433152	ROCKSTAR 753	2015-4417				SEC19-T06S-R26E
AMC 433153	ROCKSTAR 754	2015-4418				SEC20-T06S-R26E
AMC 433154	ROCKSTAR 755	2015-4419				SEC20-T06S-R26E
AMC 433155	ROCKSTAR 756	2015-4420				SEC20-T06S-R26E
AMC 433156	ROCKSTAR 757	2015-4421				SEC20-T06S-R26E
AMC 433157	ROCKSTAR 758	2015-4422				SEC20-T06S-R26E

Date: 5/23/2018

PHOENIX, ARIZONA  
 2018 JUN 25 P 1:04

RECEIVED  
 BLM AZ STATE OFFICE



## EXHIBIT A

County: Graham

State: AZ

<u>BLM Serial #</u>	<u>Claim Name</u>	<u>Original Recording</u>		<u>Amended Recording</u>		<u>Location</u>
		<u>Recording #</u>	<u>Page #</u>	<u>Recording #</u>	<u>Page #</u>	
AMC 433158	ROCKSTAR 759	2015-4423				SEC20-T06S-R26E
AMC 433159	ROCKSTAR 760	2015-4424				SEC20-T06S-R26E
AMC 433160	ROCKSTAR 761	2015-4425				SEC20-T06S-R26E
AMC 433161	ROCKSTAR 762	2015-4426				SEC20-T06S-R26E
AMC 433162	ROCKSTAR 763	2015-4427				SEC20-T06S-R26E
AMC 433163	ROCKSTAR 764	2015-4428				SEC20-T06S-R26E
AMC 433164	ROCKSTAR 765	2015-4429				SEC20-T06S-R26E
AMC 433165	ROCKSTAR 766	2015-4430				SEC20-T06S-R26E
AMC 433166	ROCKSTAR 767	2015-4431				SEC20-T06S-R26E
AMC 433167	ROCKSTAR 768	2015-4432				SEC20-T06S-R26E
AMC 433168	ROCKSTAR 769	2015-4433				SEC20-T06S-R26E
AMC 433169	ROCKSTAR 770	2015-4434				SEC20-T06S-R26E
AMC 433170	ROCKSTAR 771	2015-4435				SEC20-T06S-R26E
AMC 433171	ROCKSTAR 772	2015-4436				SEC20-T06S-R26E
AMC 433172	ROCKSTAR 773	2015-4437				SEC20-T06S-R26E
AMC 433173	ROCKSTAR 774	2015-4438				SEC20-T06S-R26E
AMC 433174	ROCKSTAR 775	2015-4439				SEC20-T06S-R26E
AMC 433175	ROCKSTAR 776	2015-4440				SEC20-T06S-R26E
AMC 433176	ROCKSTAR 777	2015-4441				SEC20-T06S-R26E
AMC 433177	ROCKSTAR 778	2015-4442				SEC20-T06S-R26E
AMC 433178	ROCKSTAR 779	2015-4443				SEC20-T06S-R26E
AMC 433179	ROCKSTAR 780	2015-4444				SEC20-T06S-R26E
AMC 433180	ROCKSTAR 781	2015-4445				SEC20-T06S-R26E
AMC 433181	ROCKSTAR 782	2015-4446				SEC20-T06S-R26E
AMC 433182	ROCKSTAR 783	2015-4447				SEC20-T06S-R26E
AMC 433183	ROCKSTAR 784	2015-4448				SEC20-T06S-R26E
AMC 433184	ROCKSTAR 785	2015-4449				SEC20-T06S-R26E
AMC 433185	ROCKSTAR 786	2015-4450				SEC20-T06S-R26E
AMC 433186	ROCKSTAR 787	2015-4451				SEC20-T06S-R26E
AMC 433187	ROCKSTAR 788	2015-4452				SEC20-T06S-R26E
AMC 433188	ROCKSTAR 789	2015-4453				SEC20-T06S-R26E
AMC 433189	ROCKSTAR 790	2015-4454				SEC21-T06S-R26E
AMC 433190	ROCKSTAR 791	2015-4455				SEC21-T06S-R26E
AMC 433191	ROCKSTAR 792	2015-4456				SEC21-T06S-R26E
AMC 433192	ROCKSTAR 793	2015-4457				SEC21-T06S-R26E
AMC 433193	ROCKSTAR 794	2015-4458				SEC21-T06S-R26E
AMC 433194	ROCKSTAR 795	2015-4459				SEC21-T06S-R26E
AMC 433195	ROCKSTAR 796	2015-4460				SEC21-T06S-R26E

Date: 5/23/2018

PHOENIX, ARIZONA  
2018 JUN 25 P 1:04  
RECEIVED

RECEIVED  
BLM AZ STATE OFFICE

## EXHIBIT A

County: Graham

State: AZ

<u>BLM Serial #</u>	<u>Claim Name</u>	<u>Original Recording</u>		<u>Amended Recording</u>		<u>Location</u>
		<u>Recording #</u>	<u>Page #</u>	<u>Recording #</u>	<u>Page #</u>	
AMC 433196	ROCKSTAR 797	2015-4461				SEC21-T06S-R26E
AMC 433197	ROCKSTAR 798	2015-4462				SEC21-T06S-R26E
AMC 433198	ROCKSTAR 799	2015-4463				SEC21-T06S-R26E
AMC 433199	ROCKSTAR 800	2015-4464				SEC21-T06S-R26E
AMC 433200	ROCKSTAR 801	2015-4465				SEC21-T06S-R26E
AMC 433201	ROCKSTAR 802	2015-4466				SEC21-T06S-R26E
AMC 433202	ROCKSTAR 803	2015-4467				SEC21-T06S-R26E
AMC 433203	ROCKSTAR 804	2015-4468				SEC21-T06S-R26E
AMC 433204	ROCKSTAR 805	2015-4469				SEC21-T06S-R26E
AMC 433205	ROCKSTAR 806	2015-4470				SEC21-T06S-R26E
AMC 433206	ROCKSTAR 807	2015-4471				SEC21-T06S-R26E
AMC 433207	ROCKSTAR 808	2015-4472				SEC21-T06S-R26E
AMC 433208	ROCKSTAR 809	2015-4473				SEC21-T06S-R26E
AMC 433209	ROCKSTAR 810	2015-4474				SEC21-T06S-R26E
AMC 433210	ROCKSTAR 811	2015-4475				SEC21-T06S-R26E
AMC 433211	ROCKSTAR 812	2015-4476				SEC21-T06S-R26E
AMC 433212	ROCKSTAR 813	2015-4477				SEC21-T06S-R26E
AMC 433213	ROCKSTAR 814	2015-4478				SEC21-T06S-R26E
AMC 433214	ROCKSTAR 815	2015-4479				SEC21-T06S-R26E
AMC 433215	ROCKSTAR 816	2015-4480				SEC21-T06S-R26E
AMC 433216	ROCKSTAR 817	2015-4481				SEC21-T06S-R26E
AMC 433217	ROCKSTAR 818	2015-4482				SEC21-T06S-R26E
AMC 433218	ROCKSTAR 819	2015-4483				SEC21-T06S-R26E
AMC 433219	ROCKSTAR 820	2015-4484				SEC21-T06S-R26E
AMC 433220	ROCKSTAR 821	2015-4485				SEC21-T06S-R26E
AMC 433221	ROCKSTAR 822	2015-4486				SEC21-T06S-R26E
AMC 433222	ROCKSTAR 823	2015-4487				SEC21-T06S-R26E
AMC 433223	ROCKSTAR 824	2015-4488				SEC21-T06S-R26E
AMC 433224	ROCKSTAR 825	2015-4489				SEC21-T06S-R26E
AMC 433225	ROCKSTAR 826	2015-4490				SEC22-T06S-R26E
AMC 433226	ROCKSTAR 827	2015-4491				SEC22-T06S-R26E
AMC 433227	ROCKSTAR 828	2015-4492				SEC22-T06S-R26E
AMC 433228	ROCKSTAR 829	2015-4493				SEC22-T06S-R26E
AMC 433229	ROCKSTAR 830	2015-4494				SEC22-T06S-R26E
AMC 433230	ROCKSTAR 831	2015-4495				SEC22-T06S-R26E
AMC 433231	ROCKSTAR 832	2015-4496				SEC22-T06S-R26E
AMC 433232	ROCKSTAR 833	2015-4497				SEC22-T06S-R26E
AMC 433233	ROCKSTAR 834	2015-4498				SEC22-T06S-R26E

Date: 5/23/2018

RECEIVED  
BLM AZ STATE OFFICE  
2018 JUN 25 P 1:04  
PHOENIX, ARIZONA

## EXHIBIT A

County: Graham

State: AZ

<u>BLM Serial #</u>	<u>Claim Name</u>	<u>Original Recording</u>		<u>Amended Recording</u>		<u>Location</u>
		<u>Recording #</u>	<u>Page #</u>	<u>Recording #</u>	<u>Page #</u>	
AMC 433234	ROCKSTAR 835	2015-4499				SEC22-T06S-R26E
AMC 433235	ROCKSTAR 836	2015-4500				SEC22-T06S-R26E
AMC 433236	ROCKSTAR 837	2015-4501				SEC22-T06S-R26E
AMC 433237	ROCKSTAR 838	2015-4502				SEC22-T06S-R26E
AMC 433238	ROCKSTAR 839	2015-4503				SEC22-T06S-R26E
AMC 433239	ROCKSTAR 840	2015-4504				SEC22-T06S-R26E
AMC 433240	ROCKSTAR 841	2015-4505				SEC22-T06S-R26E
AMC 433241	ROCKSTAR 842	2015-4506				SEC22-T06S-R26E
AMC 433242	ROCKSTAR 843	2015-4507				SEC22-T06S-R26E
AMC 433243	ROCKSTAR 844	2015-4508				SEC22-T06S-R26E
AMC 433244	ROCKSTAR 845	2015-4509				SEC22-T06S-R26E
AMC 433245	ROCKSTAR 846	2015-4510				SEC22-T06S-R26E
AMC 433246	ROCKSTAR 847	2015-4511				SEC22-T06S-R26E
AMC 433247	ROCKSTAR 848	2015-4512				SEC22-T06S-R26E
AMC 433248	ROCKSTAR 849	2015-4513				SEC22-T06S-R26E
AMC 433249	ROCKSTAR 850	2015-4514				SEC22-T06S-R26E
AMC 433250	ROCKSTAR 851	2015-4515				SEC22-T06S-R26E
AMC 433251	ROCKSTAR 852	2015-4516				SEC22-T06S-R26E
AMC 433252	ROCKSTAR 853	2015-4517				SEC22-T06S-R26E
AMC 433253	ROCKSTAR 854	2015-4518				SEC22-T06S-R26E
AMC 433254	ROCKSTAR 855	2015-4519				SEC22-T06S-R26E
AMC 433255	ROCKSTAR 856	2015-4520				SEC22-T06S-R26E
AMC 433256	ROCKSTAR 857	2015-4521				SEC22-T06S-R26E
AMC 433257	ROCKSTAR 858	2015-4522				SEC22-T06S-R26E
AMC 433258	ROCKSTAR 859	2015-4523				SEC22-T06S-R26E
AMC 433259	ROCKSTAR 860	2015-4524				SEC22-T06S-R26E
AMC 433260	ROCKSTAR 861	2015-4525				SEC22-T06S-R26E
AMC 433261	ROCKSTAR 862	2015-4526				SEC27-T06S-R26E
AMC 433262	ROCKSTAR 863	2015-4527				SEC27-T06S-R26E
AMC 433263	ROCKSTAR 864	2015-4528				SEC27-T06S-R26E
AMC 433264	ROCKSTAR 865	2015-4529				SEC27-T06S-R26E
AMC 433265	ROCKSTAR 866	2015-4530				SEC27-T06S-R26E
AMC 433266	ROCKSTAR 867	2015-4531				SEC27-T06S-R26E
AMC 433267	ROCKSTAR 868	2015-4532				SEC27-T06S-R26E
AMC 433268	ROCKSTAR 869	2015-4533				SEC27-T06S-R26E
AMC 433269	ROCKSTAR 870	2015-4534				SEC27-T06S-R26E
AMC 433270	ROCKSTAR 871	2015-4535				SEC27-T06S-R26E
AMC 433271	ROCKSTAR 872	2015-4536				SEC27-T06S-R26E

Date: 5/23/2018

PHOENIX, ARIZONA

2018 JUN 25 P 1:00

RECEIVED  
BLM AZ STATE OFFICE

## EXHIBIT A

County: Graham

State: AZ

<u>BLM Serial #</u>	<u>Claim Name</u>	<u>Original Recording</u>		<u>Amended Recording</u>		<u>Location</u>
		<u>Recording #</u>	<u>Page #</u>	<u>Recording #</u>	<u>Page #</u>	
AMC 433272	ROCKSTAR 873	2015-4537				SEC27-T06S-R26E
AMC 433273	ROCKSTAR 874	2015-4538				SEC27-T06S-R26E
AMC 433274	ROCKSTAR 875	2015-4539				SEC27-T06S-R26E
AMC 433275	ROCKSTAR 876	2015-4540				SEC27-T06S-R26E
AMC 433276	ROCKSTAR 877	2015-4541				SEC27-T06S-R26E
AMC 433277	ROCKSTAR 878	2015-4542				SEC27-T06S-R26E
AMC 433278	ROCKSTAR 879	2015-4543				SEC27-T06S-R26E
AMC 433279	ROCKSTAR 880	2015-4544				SEC27-T06S-R26E
AMC 433280	ROCKSTAR 881	2015-4545				SEC27-T06S-R26E
AMC 433281	ROCKSTAR 882	2015-4546				SEC28-T06S-R26E
AMC 433282	ROCKSTAR 883	2015-4547				SEC28-T06S-R26E
AMC 433283	ROCKSTAR 884	2015-4548				SEC28-T06S-R26E
AMC 433284	ROCKSTAR 885	2015-4549				SEC28-T06S-R26E
AMC 433285	ROCKSTAR 886	2015-4550				SEC28-T06S-R26E
AMC 433286	ROCKSTAR 887	2015-4551				SEC28-T06S-R26E
AMC 433287	ROCKSTAR 888	2015-4552				SEC28-T06S-R26E
AMC 433288	ROCKSTAR 889	2015-4553				SEC28-T06S-R26E
AMC 433289	ROCKSTAR 890	2015-4554				SEC28-T06S-R26E
AMC 433290	ROCKSTAR 891	2015-4555				SEC28-T06S-R26E
AMC 433291	ROCKSTAR 892	2015-4556				SEC28-T06S-R26E
AMC 433292	ROCKSTAR 893	2015-4557				SEC28-T06S-R26E
AMC 433293	ROCKSTAR 894	2015-4558				SEC28-T06S-R26E
AMC 433294	ROCKSTAR 895	2015-4559				SEC28-T06S-R26E
AMC 433295	ROCKSTAR 896	2015-4560				SEC28-T06S-R26E
AMC 433296	ROCKSTAR 897	2015-4561				SEC28-T06S-R26E
AMC 433297	ROCKSTAR 898	2015-4562				SEC28-T06S-R26E
AMC 433298	ROCKSTAR 899	2015-4563				SEC28-T06S-R26E
AMC 433299	ROCKSTAR 900	2015-4564				SEC28-T06S-R26E
AMC 433300	ROCKSTAR 901	2015-4565				SEC28-T06S-R26E
AMC 433301	ROCKSTAR 902	2015-4566				SEC28-T06S-R26E
AMC 433302	ROCKSTAR 903	2015-4567				SEC28-T06S-R26E
AMC 433303	ROCKSTAR 904	2015-4568				SEC28-T06S-R26E
AMC 433304	ROCKSTAR 905	2015-4569				SEC28-T06S-R26E
AMC 433305	ROCKSTAR 906	2015-4570				SEC28-T06S-R26E
AMC 433306	ROCKSTAR 907	2015-4571				SEC28-T06S-R26E
AMC 433307	ROCKSTAR 908	2015-4572				SEC28-T06S-R26E
AMC 433308	ROCKSTAR 909	2015-4573				SEC28-T06S-R26E
AMC 433309	ROCKSTAR 910	2015-4574				SEC28-T06S-R26E

Date: 5/23/2018

RECEIVED  
BLM AZ STATE OFFICE  
2018 JUN 25 P 1:05  
PHOENIX, ARIZONA

## EXHIBIT A

County: Graham

State: AZ

<u>BLM Serial #</u>	<u>Claim Name</u>	<u>Original Recording</u>		<u>Amended Recording</u>		<u>Location</u>
		<u>Recording #</u>	<u>Page #</u>	<u>Recording #</u>	<u>Page #</u>	
AMC 433310	ROCKSTAR 911	2015-4575				SEC29-T06S-R26E
AMC 433311	ROCKSTAR 912	2015-4576				SEC29-T06S-R26E
AMC 433312	ROCKSTAR 913	2015-4577				SEC29-T06S-R26E
AMC 433313	ROCKSTAR 914	2015-4578				SEC29-T06S-R26E
AMC 433314	ROCKSTAR 915	2015-4579				SEC29-T06S-R26E
AMC 433315	ROCKSTAR 916	2015-4580				SEC29-T06S-R26E
AMC 433316	ROCKSTAR 917	2015-4581				SEC29-T06S-R26E
AMC 433317	ROCKSTAR 918	2015-4582				SEC29-T06S-R26E
AMC 433318	ROCKSTAR 919	2015-4583				SEC29-T06S-R26E
AMC 433319	ROCKSTAR 920	2015-4584				SEC29-T06S-R26E
AMC 433320	ROCKSTAR 921	2015-4585				SEC29-T06S-R26E
AMC 433321	ROCKSTAR 922	2015-4586				SEC29-T06S-R26E
AMC 433322	ROCKSTAR 923	2015-4587				SEC29-T06S-R26E
AMC 433323	ROCKSTAR 924	2015-4588				SEC29-T06S-R26E
AMC 433324	ROCKSTAR 925	2015-4589				SEC29-T06S-R26E
AMC 433325	ROCKSTAR 926	2015-4590				SEC29-T06S-R26E
AMC 433326	ROCKSTAR 927	2015-4591				SEC29-T06S-R26E
AMC 433327	ROCKSTAR 928	2015-4592				SEC29-T06S-R26E
AMC 433328	ROCKSTAR 929	2015-4593				SEC29-T06S-R26E
AMC 433329	ROCKSTAR 930	2015-4594				SEC30-T06S-R26E
AMC 433330	ROCKSTAR 931	2015-4595				SEC30-T06S-R26E
AMC 433331	ROCKSTAR 932	2015-4596		2017-00416		SEC30-T06S-R26E
AMC 433332	ROCKSTAR 933	2015-4597		2017-00417		SEC30-T06S-R26E
AMC 433333	ROCKSTAR 934	2015-4598		2017-00418		SEC30-T06S-R26E
AMC 433334	ROCKSTAR 935	2015-4599		2017-00419		SEC30-T06S-R26E
AMC 433335	ROCKSTAR 936	2015-4600		2017-00420		SEC30-T06S-R26E
AMC 433336	ROCKSTAR 937	2015-4601		2017-00421		SEC30-T06S-R26E
AMC 433344	ROCKSTAR 945	2015-4609		2017-00422		SEC30-T06S-R26E
AMC 433345	ROCKSTAR 946	2015-4610				SEC30-T06S-R26E
AMC 433346	ROCKSTAR 947	2015-4611				SEC30-T06S-R26E
AMC 433347	ROCKSTAR 948	2015-4612				SEC30-T06S-R26E
AMC 433355	ROCKSTAR 956	2015-4620				SEC31-T06S-R26E
AMC 433356	ROCKSTAR 957	2015-4621				SEC31-T06S-R26E
AMC 433357	ROCKSTAR 958	2015-4622				SEC32-T06S-R26E
AMC 433358	ROCKSTAR 959	2015-4623				SEC32-T06S-R26E
AMC 433359	ROCKSTAR 960	2015-4624				SEC31-T06S-R26E
AMC 433360	ROCKSTAR 961	2015-4625				SEC31-T06S-R26E
AMC 433361	ROCKSTAR 962	2015-4626				SEC31-T06S-R26E

Date: 5/23/2018

PHOENIX, ARIZONA  
 2018 JUN 25 P 1:05

RECEIVED  
 BLM AZ STATE OFFICE

## EXHIBIT A

County: Graham

State: AZ

<u>BLM Serial #</u>	<u>Claim Name</u>	<u>Original Recording</u>		<u>Amended Recording</u>		<u>Location</u>
		<u>Recording #</u>	<u>Page #</u>	<u>Recording #</u>	<u>Page #</u>	
AMC 433362	ROCKSTAR 963	2015-4627				SEC31-T06S-R26E
AMC 433363	ROCKSTAR 964	2015-4628				SEC31-T06S-R26E
AMC 433364	ROCKSTAR 965	2015-4629				SEC31-T06S-R26E
AMC 433365	ROCKSTAR 966	2015-4630				SEC31-T06S-R26E
AMC 433366	ROCKSTAR 967	2015-4631				SEC31-T06S-R26E
AMC 433367	ROCKSTAR 968	2015-4632				SEC31-T06S-R26E
AMC 433368	ROCKSTAR 969	2015-4633				SEC31-T06S-R26E
AMC 433369	ROCKSTAR 970	2015-4634				SEC31-T06S-R26E
AMC 433370	ROCKSTAR 971	2015-4635				SEC31-T06S-R26E
AMC 433371	ROCKSTAR 973	2015-4636				SEC31-T06S-R26E
AMC 433372	ROCKSTAR 974	2015-4637				SEC32-T06S-R26E
AMC 433373	ROCKSTAR 975	2015-4638				SEC31-T06S-R26E
AMC 433374	ROCKSTAR 976	2015-4639				SEC31-T06S-R26E
AMC 433375	ROCKSTAR 977	2015-4640				SEC32-T06S-R26E
AMC 433376	ROCKSTAR 978	2015-4641				SEC32-T06S-R26E
AMC 433377	ROCKSTAR 979	2015-4642				SEC32-T06S-R26E
AMC 433378	ROCKSTAR 980	2015-4643				SEC32-T06S-R26E
AMC 433379	ROCKSTAR 981	2015-4644				SEC32-T06S-R26E
AMC 433380	ROCKSTAR 982	2015-4645				SEC32-T06S-R26E
AMC 433381	ROCKSTAR 983	2015-4646				SEC32-T06S-R26E
AMC 433382	ROCKSTAR 984	2015-4647				SEC32-T06S-R26E
AMC 433383	ROCKSTAR 985	2015-4648				SEC32-T06S-R26E
AMC 433384	ROCKSTAR 986	2015-4649				SEC32-T06S-R26E
AMC 433385	ROCKSTAR 987	2015-4650				SEC32-T06S-R26E
AMC 433386	ROCKSTAR 988	2015-4651				SEC32-T06S-R26E
AMC 433387	ROCKSTAR 989	2015-4652				SEC32-T06S-R26E
AMC 433388	ROCKSTAR 990	2015-4653				SEC32-T06S-R26E
AMC 433389	ROCKSTAR 991	2015-4654				SEC33-T06S-R26E
AMC 433390	ROCKSTAR 992	2015-4655				SEC33-T06S-R26E
AMC 433391	ROCKSTAR 993	2015-4656				SEC33-T06S-R26E
AMC 433392	ROCKSTAR 994	2015-4657				SEC33-T06S-R26E
AMC 433393	ROCKSTAR 995	2015-4658				SEC33-T06S-R26E
AMC 433394	ROCKSTAR 996	2015-4659				SEC33-T06S-R26E
AMC 433395	ROCKSTAR 997	2015-4660				SEC33-T06S-R26E
AMC 433396	ROCKSTAR 998	2015-4661				SEC33-T06S-R26E
AMC 433397	ROCKSTAR 999	2015-4662				SEC33-T06S-R26E
AMC 433398	ROCKSTAR 1000	2015-4663				SEC33-T06S-R26E
AMC 433399	ROCKSTAR 1001	2015-4664				SEC33-T06S-R26E

Date: 5/23/2018

PHOENIX, ARIZONA  
2018 JUN 25 P 1:05

RECEIVED  
BLM AZ STATE OFFICE

## EXHIBIT A

County: Graham

State: AZ

BLM Serial #	Claim Name	Original Recording		Amended Recording		Location
		Recording #	Page #	Recording #	Page #	
AMC 433400	ROCKSTAR 1002	2015-4665				SEC33-T06S-R26E
AMC 433401	ROCKSTAR 1003	2015-4666				SEC32-T06S-R26E
AMC 433402	ROCKSTAR 1004	2015-4667				SEC32-T06S-R26E
AMC 433403	ROCKSTAR 1005	2015-4668				SEC32-T06S-R26E
AMC 433404	ROCKSTAR 1006	2015-4669				SEC33-T06S-R26E
AMC 433405	ROCKSTAR 1007	2015-4670				SEC33-T06S-R26E
AMC 433406	ROCKSTAR 1008	2015-4671				SEC28-T06S-R26E
AMC 433439	Red Bull-681	2015-4746				SEC22-T05S-R26E
AMC 433440	Red Bull-682	2015-4747				SEC22-T05S-R26E
AMC 433441	Red Bull-683	2015-4748				SEC22-T05S-R26E
AMC 433442	Red Bull-684	2015-4749				SEC22-T05S-R26E
AMC 433443	Red Bull-685	2015-4750				SEC22-T05S-R26E
AMC 433444	Red Bull-686	2015-4751				SEC22-T05S-R26E
AMC 433448	Red Bull-690	2015-4755				SEC22-T05S-R26E
AMC 433449	Red Bull-691	2015-4756				SEC22-T05S-R26E
AMC 433450	Red Bull-692	2015-4757				SEC22-T05S-R26E
AMC 433451	Red Bull-693	2015-4758				SEC22-T05S-R26E
AMC 433452	Red Bull-694	2015-4759				SEC22-T05S-R26E
AMC 433453	Red Bull-695	2015-4760				SEC22-T05S-R26E
AMC 433457	Red Bull-699	2015-4764				SEC09-T05S-R26E
AMC 433458	Red Bull-700	2015-4765				SEC09-T05S-R26E
AMC 433469	Red Bull-711	2015-4776				SEC09-T05S-R26E
AMC 433470	Red Bull-712	2015-4777				SEC09-T05S-R26E
AMC 433471	Red Bull-713	2015-4778				SEC09-T05S-R26E
AMC 433472	Red Bull-714	2015-4779				SEC09-T05S-R26E
AMC 433473	Red Bull-715	2015-4780				SEC09-T05S-R26E
AMC 433474	Red Bull-716	2015-4781				SEC09-T05S-R26E
AMC 433475	Red Bull-717	2015-4782				SEC09-T05S-R26E
AMC 433476	Red Bull-718	2015-4783				SEC09-T05S-R26E
AMC 433477	Red Bull-719	2015-4784				SEC09-T05S-R26E
AMC 433478	Red Bull-720	2015-4785				SEC09-T05S-R26E
AMC 433479	Red Bull-721	2015-4786				SEC09-T05S-R26E
AMC 433480	Red Bull-722	2015-4787				SEC09-T05S-R26E
AMC 433481	Red Bull-723	2015-4788				SEC09-T05S-R26E
AMC 433482	Red Bull-724	2015-4789				SEC09-T05S-R26E
AMC 433483	Red Bull-725	2015-4790				SEC09-T05S-R26E
AMC 433484	Red Bull-726	2015-4791				SEC09-T05S-R26E
AMC 433485	Red Bull-727	2015-4792				SEC09-T05S-R26E

Date: 5/23/2018

PHOENIX, ARIZONA  
 2018 JUN 25 P 1:05  
 RECEIVED  
 BLM AZ STATE OFFICE

## EXHIBIT A

County: Graham

State: AZ

BLM Serial #	Claim Name	Original Recording		Amended Recording		Location
		Recording #	Page #	Recording #	Page #	
AMC 433486	Red Bull-728	2015-4793				SEC09-T05S-R26E
AMC 433487	Red Bull-729	2015-4794				SEC09-T05S-R26E
AMC 433488	Red Bull-730	2015-4795				SEC09-T05S-R26E
AMC 433489	Red Bull-731	2015-4796				SEC09-T05S-R26E
AMC 433490	Red Bull-732	2015-4797				SEC09-T05S-R26E
AMC 433491	Red Bull-733	2015-4798				SEC09-T05S-R26E
AMC 433492	Red Bull-734	2015-4799				SEC04-T05S-R26E
AMC 433493	Red Bull-735	2015-4800				SEC04-T05S-R26E
AMC 433494	Red Bull-736	2015-4801				SEC04-T05S-R26E
AMC 433495	Red Bull-737	2015-4802				SEC05-T05S-R26E
AMC 433496	Red Bull-738	2015-4803				SEC05-T05S-R26E
AMC 433497	Red Bull-739	2015-4804				SEC05-T05S-R26E
AMC 78650	Melody #1	77	472			SEC11-T06S-R26E
AMC 78651	Melody #5	77	474			SEC11-T06S-R26E
AMC 78652	Melody #7	77	475			SEC11-T06S-R26E
AMC 78653	Melody #9	77	476			SEC11-T06S-R26E
AMC 78654	Melody #11	77	477			SEC11-T06S-R26E
AMC 78655	Melody #8	77	490			SEC11-T06S-R26E
AMC 78656	Melody #10	77	491			SEC11-T06S-R26E
AMC 78657	Melody #18	77	495			SEC14-T06S-R26E
AMC 78658	Melody #20	77	496			SEC14-T06S-R26E
AMC 78659	Melody #13	77	478			SEC11-T06S-R26E
AMC 78660	Melody #17	77	480			SEC14-T06S-R26E
AMC 78661	Melody #19	77	481			SEC14-T06S-R26E
AMC 78662	Melody #21	77	482			SEC14-T06S-R26E
AMC 78663	Melody #23	77	483			SEC14-T06S-R26E
AMC 78664	Melody #27	77	485			SEC14-T06S-R26E
AMC 78665	Melody #29	77	486			SEC14-T06S-R26E
AMC 78666	Melody #31	257	540			SEC14-T06S-R26E
AMC 78667	Melody #32	257	541			SEC14-T06S-R26E
AMC 78668	Melody #16	77	494			SEC11-T06S-R26E
AMC 78669	Melody #3	77	473			SEC11-T06S-R26E
AMC 78670	Melody #15	77	479			SEC11-T06S-R26E
AMC 78671	Melody #25	77	484			SEC14-T06S-R26E
No. Of Claims	3530					

PHOENIX, ARIZONA

2018 JUN 25 P 11:05

RECEIVED  
BLM AZ STATE OFFICE

Date: 5/23/2018



**United States Department of the Interior**  
**Bureau of Land Management**  
 DIV OF LANDS, MINRLS & ENERGY  
 ONE N CENTRAL AVE  
 PHOENIX, AZ 85004 -4427  
 Phone: 602-417-9200

Receipt

No: 4196364

<b>Transaction #:</b> 4311167	
<b>Date of Transaction:</b> 06/25/2018	
CUSTOMER:	
FREEPORT MCMORAN INC 333 N CENTRAL AVE PHOENIX,AZ 85004-2121 US	

LINE #	QTY	DESCRIPTION	REMARKS	UNIT PRICE	TOTAL
1	1.00	LOCATABLE MINERALS / MINING CLAIMS- NOT NEW-UNADJUD,ONE AUTH NO. ONLY / MINING CLAIM MONEY RECEIVED CASES: AMC46122/\$547150.00	MAINT 2019/3530	- n/a -	547150.00
<b>TOTAL:</b>					<b>\$547,150.00</b>

PAYMENT INFORMATION			
1	AMOUNT:	547150.00	POSTMARKED: N/A
	TYPE:	CHECK	RECEIVED: 06/25/2018
	CHECK NO:	0000899226	
	NAME:	FREEPORT MCMORAN INC 333 N CENTRAL AVE PHOENIX AZ 85004-2121 US	

REMARKS

This receipt was generated by the automated BLM Collections and Billing System and is a paper representation of a portion of the official electronic record contained therein.

2

359924

432933

364985

431317

Southwest Exploration Group LLC  
580 S. Prospectors Road  
Apache Junction, AZ 85119

432120

August 30, 2017

Arizona State Office  
Bureau of Land Management  
One N Central Ave, Suite 800  
Phoenix AZ 85004-4427

RECEIVED  
BLM AZ STATE OFFICE  
2017 SEP - 1 A 8:15  
PHOENIX, ARIZONA

Dear Arizona State Office Personnel,

Enclosed are checks totaling \$17,980.00 for maintenance fees for 116 unpatented mining claims listed on Exhibit A.

Best regards,

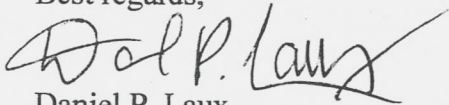

Daniel P. Laux  
Member  
Southwest Exploration Group LLC

#3971278

ENTERED  
SEP 01 2017  
BY: Rana

# Exhibit A - Graham County Claim Listing

Southwest Exploration Group LLC

18/30/2017

	Name	AMC#	Graham Co. Info	TWP	RNG	SEC
1	CS-1	AMC359924	2004-00903	5S	26E	20
2	CS-2	AMC359925	2004-00904	5S	26E	20
3	CS-3	AMC359926	2004-00905	5S	26E	20
4	CS-4	AMC359927	2004-00906	5S	26E	20
5	CS-5	AMC359928	2004-00907	5S	26E	20
6	CS-6	AMC359929	2004-00908	5S	26E	20
7	CS-7	AMC359930	2004-00909	5S	26E	20
8	CS-8	AMC359931	2004-00910	5S	26E	20
9	CS-9	AMC359932	2004-00911	5S	26E	17
10	CS-10	AMC359933	2004-00912	5S	26E	17
11	CS-11	AMC359934	2004-00913	5S	26E	17
12	CS-12	AMC359935	2004-00914	5S	26E	17
13	CS-13	AMC359936	2004-00915	5S	26E	17
14	CS-14	AMC359937	2004-00916	5S	26E	17
15	CS-27	AMC359950	2004-00929	5S	26E	19/20
16	CS-28	AMC359951	2004-00930	5S	26E	20
17	CS-29	AMC359952	2004-00931	5S	26E	19/20
18	CS-30	AMC359953	2004-00932	5S	26E	20
19	CS-31	AMC359954	2004-00933	5S	26E	19/20
20	CS-32	AMC359955	2004-00934	5S	26E	20
21	CS-33	AMC359956	2004-00935	5S	26E	19/20
22	CS-34	AMC359957	2004-00936	5S	26E	20
23	CS-35	AMC359958	2004-00937	5S	26E	17/18
24	CS-36	AMC359959	2004-00938	5S	26E	17
25	CS-37	AMC359960	2004-00939	5S	26E	17/18
26	CS-38	AMC359961	2004-00940	5S	26E	17
27	CS-39	AMC359962	2004-00941	5S	26E	17/18
28	CS-40	AMC359963	2004-00942	5S	26E	17
29	CS-41	AMC432933	2015-04201	5S	26E	17/18
30	CS-42	AMC432934	2015-04202	5S	26E	17
31	CS-43	AMC432935	2015-04203	5S	26E	17/18
32	CS-44	AMC432936	2015-04204	5S	26E	17
33	CS-45	AMC432937	2015-04205	5S	26E	17/18
34	CS-46	AMC432938	2015-04206	5S	26E	17
35	CS-47	AMC432939	2015-04207	5S	26E	17/18
36	CS-48	AMC432940	2015-04208	5S	26E	17
37	CS-49	AMC432941	2015-04209	5S	26E	17/18
38	CS-50	AMC432942	2015-04210	5S	26E	17
39	CS-51	AMC432943	2015-04211	5S	26E	17/18
40	CS-52	AMC432944	2015-04212	5S	26E	17
41	CS-53	AMC359976	2004-00955	5S	26E	21

PHOENIX, ARIZONA  
 RECEIVED  
 BLM AZ STATE OFFICE  
 2017 SEP - 14 8 15

# Exhibit A - Graham County Claim Listing

Southwest Exploration Group LLC

18/30/2017

	Name	AMC#	Graham Co. Info	TWP	RNG	SEC
42	CS-54	AMC359977	2004-00956	5S	26E	21
43	CS-55	AMC359978	2004-00957	5S	26E	21
44	CS-56	AMC364985	2005-02173	5S	26E	19
45	CS-57	AMC364986	2005-02174	5S	26E	19
46	CS-58	AMC364987	2005-02175	5S	26E	19
47	CS-59	AMC364988	2005-02176	5S	26E	19
48	CS-60	AMC364989	2005-02177	5S	26E	19
49	CS-61	AMC364990	2005-02178	5S	26E	19
50	CS-62	AMC364991	2005-02179	5S	26E	19
51	CS-63	AMC364992	2005-02180	5S	26E	19
52	CS-64	AMC364993	2005-02181	5S	26E	19
53	CS-65	AMC364994	2005-02182	5S	26E	18
54	CS-66	AMC364995	2005-02183	5S	26E	18
55	CS-67	AMC364996	2005-02184	5S	26E	18
56	CS-68	AMC364997	2005-02185	5S	26E	18
57	CS-69	AMC364998	2005-02186	5S	26E	18
58	CS-82	AMC365011	2005-02199	5S	26E	19
59	CS-83	AMC365012	2005-02200	5S	26E	19
60	CS-84	AMC365013	2005-02201	5S	26E	19
61	CS-85	AMC365014	2005-02202	5S	26E	19
62	CS-86	AMC365015	2005-02203	5S	26E	18
63	CS-87	AMC365016	2005-02204	5S	26E	18
64	CS-88	AMC365017	2005-02205	5S	26E	18
65	RED BULL - 397	AMC431506	2015-2148	T5S	R25-26E	13/24;18/19
66	RED BULL - 398	AMC431507	2015-2149	T5S	R25-26E	13;18
67	RED BULL - 399	AMC431508	2015-2150	T5S	R25-26E	13;18
68	RED BULL - 400	AMC431509	2015-2151	T5S	R25-26E	13;18
69	RED BULL - 401	AMC431510	2015-2152	T5S	R25-26E	13;18
70	RED BULL - 402	AMC431511	2015-2153	T5S	R25-26E	13;18
71	RED BULL - 403	AMC431512	2015-2154	T5S	R25-26E	13;18
72	RED BULL - 404	AMC431513	2015-2155	T5S	R25-26E	13;18
73	RED BULL - 405	AMC431514	2015-2156	T5S	R25-26E	13;18
74	RED BULL - 406	AMC431515	2015-2157	T5S	R25E	13/24
75	RED BULL - 407	AMC431516	2015-2158	T5S	R25E	13
76	RED BULL - 408	AMC431517	2015-2159	T5S	R25E	13
77	RED BULL - 409	AMC431518	2015-2160	T5S	R25E	13
78	RED BULL - 410	AMC431519	2015-2161	T5S	R25E	13
79	RED BULL - 411	AMC431520	2015-2162	T5S	R25E	13
80	RED BULL - 412	AMC431521	2015-2163	T5S	R25E	13
81	RED BULL - 413	AMC431522	2015-2164	T5S	R25E	13
82	RED BULL - 414	AMC431523	2015-2165	T5S	R25E	13

RECEIVED  
 BLM AZ STATE OFFICE  
 2017 SEP - 1 A 8 15

# Exhibit A - Graham County Claim Listing

Southwest Exploration Group LLC

18/30/2017

	Name	AMC#	Graham Co. Info	TWP	RNG	SEC
83	RED BULL - 415	AMC431524	7 2015-2166	T5S	R25E	13/24
84	RED BULL - 416	AMC431525	2015-2167	T5S	R25E	13
85	RED BULL - 417	AMC431526	2015-2168	T5S	R25E	13
86	RED BULL - 418	AMC431527	2015-2169	T5S	R25E	13
87	RED BULL - 419	AMC431528	2015-2170	T5S	R25E	13
88	RED BULL - 420	AMC431529	2015-2171	T5S	R25E	13
89	RED BULL - 421	AMC431530	2015-2172	T5S	R25E	13
90	RED BULL - 422	AMC431531	2015-2173	T5S	R25E	13
91	RED BULL - 423	AMC431532	2015-2174	T5S	R25E	13
92	RED BULL - 424	AMC431533	2015-2175	T5S	R25E	13/14/23/24
93	RED BULL - 425	AMC431534	2015-2176	T5S	R25E	13/14
94	RED BULL - 426	AMC431535	2015-2177	T5S	R25E	13/14
95	RED BULL - 427	AMC431536	2015-2178	T5S	R25E	13/14
96	RED BULL - 428	AMC431537	2015-2179	T5S	R25E	13/14
97	RED BULL - 429	AMC431538	2015-2180	T5S	R25E	13/14
98	RED BULL - 430	AMC431539	2015-2181	T5S	R25E	13/14
99	RED BULL - 431	AMC431540	2015-2182	T5S	R25E	13/14
100	RED BULL - 432	AMC431541	J 2015-2183	T5S	R25E	13/14
101	RED BULL - 438	AMC432143	7 2015-3044	T5S	R25-26E	24;19
102	RED BULL - 439	AMC432144	7 2015-3045	T5S	R25-26E	24;19
103	RED BULL - 440	AMC432145	2015-3046	T5S	R25-26E	24;19
104	RED BULL - 441	AMC432146	J 2015-3047	T5S	R25-26E	24;19
105	RED BULL - 447	AMC432152	7 2015-3053	T5S	R25E	24
106	RED BULL - 448	AMC432153	7 2015-3054	T5S	R25E	24
107	RED BULL - 449	AMC432154	2015-3055	T5S	R25E	24
108	RED BULL - 450	AMC432155	J 2015-3056	T5S	R25E	24
109	RED BULL - 456	AMC432161	7 2015-3062	T5S	R25E	24
110	RED BULL - 457	AMC432162	7 2015-3063	T5S	R25E	24
111	RED BULL - 458	AMC432163	J 2015-3064	T5S	R25E	24
112	RED BULL - 459	AMC432164	J 2015-3065	T5S	R25E	24
113	RED BULL - 465	AMC432170	7 2015-3071	T5S	R25E	23/24
114	RED BULL - 466	AMC432171	7 2015-3072	T5S	R25E	23/24
115	RED BULL - 467	AMC432172	J 2015-3073	T5S	R25E	23/24
116	RED BULL - 468	AMC432173	J 2015-3074	T5S	R25E	23/24

RECEIVED  
 BLM AZ STATE OFFICE  
 2011 SEP - 1 A 8:16  
 PHOENIX, ARIZONA

**United States Department of the Interior  
Bureau of Land Management**

DIV OF LANDS, MINRLS & ENERGY  
ONE N CENTRAL AVE  
PHOENIX, AZ 85004 -4427  
Phone: 602-417-9200

Receipt

No: 3971278

<b>Transaction #:</b> 4081209	
<b>Date of Transaction:</b> 09/05/2017	
<b>CUSTOMER:</b>	
SOUTHWEST EXPLORATION GROUP LLC 580 S PROSPECTORS RD APACHE JUNCTION, AZ 85119-8828 US	

LINE #	QTY	DESCRIPTION	REMARKS	UNIT PRICE	TOTAL
1	1.00	LOCATABLE MINERALS / MINING CLAIMS- NOT NEW-UNADJUD, ONE AUTH NO. ONLY / MINING CLAIM MONEY RECEIVED CASES: AMC359924/\$17980.00	MAINT 2018/116	- n/a -	17980.00
<b>TOTAL:</b>					<b>\$17,980.00</b>

PAYMENT INFORMATION					
1	AMOUNT:	11687.00	POSTMARKED:	08/30/2017	
	TYPE:	CHECK	RECEIVED:	09/01/2017	
	CHECK NO:	1163			
	NAME:	SOUTHWEST EXPLORATION GROUP LLC 580 S PROSPECTORS RD APACHE JUNCTION AZ 85119-8828 US			
2	AMOUNT:	6293.00	POSTMARKED:	08/30/2017	
	TYPE:	CHECK	RECEIVED:	09/01/2017	
	CHECK NO:	13076			
	NAME:	GODBE DRILLING LLC, 62802 OHLM RD MONTROSE CO 81403 US			

REMARKS

This receipt was generated by the automated BLM Collections and Billing System and is a paper representation of a portion of the official electronic record contained therein.



78466

431566

431611

46122

431791 329064

298929 47901

431904 329094

305755 66892

432120 330967

321860 101235

432241 331727

324229 113312

432443 333390

324366 288506

432486 334772

324842 289500

432621 340495

326065 292727

432994 340956

326786 293492

433439 341652

2017

July 6, 2017

After recording, return to:  
Freeport-McMoRan  
Attn: C. Loder  
333 North Central Avenue  
Phoenix, AZ 85004

Bureau of Land Management  
Department of the Interior  
One N. Central Avenue  
Phoenix, AZ 85004

**NOTICE OF INTENT TO HOLD MINING CLAIMS AND PAYMENT OF BLM**

441072 MAINTENANCE FEE

344109 294150

431071

430691 294346

Re: Payment of Annual Claim Maintenance Fee

431121

430751 298849

Dear Sir or Madam:

431317

430889 298861

This will serve as notice that Freeport Minerals Corporation, whose address for purposes of this filing is Land and Water Department, 333 North Central Ave., Phoenix, Arizona 85004, intends to hold the mining claims and/or mill sites described on Exhibit A attached hereto for the assessment year ending at 12 o'clock, noon, on September 1, 2018 by payment of the annual maintenance fee of \$155 per claim or site. Payment of such amount is made herewith for such assessment year for each of the claims and sites, the name, and BLM serial number with the book and page or index number of recording of the location notice in the official records of Graham County, Arizona, of which, is set forth on Exhibit A attached hereto and by this reference incorporated herein.

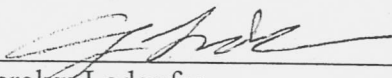
  
Carolyn Loder for  
Freeport Minerals Corporation

State of Arizona )  
) ss.  
County of Maricopa )

RECEIVED  
BLM AZ STATE OFFICE  
2017 JUL 12 A 10:00  
PHOENIX, ARIZONA

The foregoing instrument was acknowledged before me on July 6<sup>th</sup>, 2017, by Carolyn Loder, on behalf of Freeport Minerals Corporation.

(Seal)

  
STEPHANIE D. TURTON  
Notary Public - State of Arizona  
MARICOPA COUNTY  
My Commission Expires Nov. 18, 2019

Stephanie D. Turton  
Notary Public  
My commission expires: 11-18-2019

ENTERED  
JUL 13 2017  
BY: BAM

## Exhibit A

County: Graham

State: AZ

BLM Serial #	Claim Name	Original Recording		Amended Recording		Location
		Recording #	Page #	Recording #	Page #	
AMC 046122	GEM 1	210	420			SEC26-T06S-R27E
AMC 046123	GEM 2	210	421			SEC35-T06S-R27E
AMC 046124	GEM 3	210	422			SEC35-T06S-R27E
AMC 046125	GEM 4	210	423			SEC35-T06S-R27E
AMC 046126	GEM 5	210	424			SEC35-T06S-R27E
AMC 046127	GEM 6	210	425	531	520	SEC35-T06S-R27E
AMC 046131	GEM 10	210	429			SEC26-T06S-R27E
AMC 046132	GEM 11	210	430			SEC26-T06S-R27E
AMC 046133	GEM 12	210	431			SEC35-T06S-R27E
AMC 046134	GEM 13	210	432			SEC35-T06S-R27E
AMC 046135	GEM 14	210	433			SEC35-T06S-R27E
AMC 046136	GEM 15	210	434			SEC35-T06S-R27E
AMC 046137	GEM 16	210	435			SEC35-T06S-R27E
AMC 046138	GEM 17	210	436			SEC35-T06S-R27E
AMC 046139	GEM 18	210	437			SEC35-T06S-R27E
AMC 046140	GEM 19	210	438			SEC35-T06S-R27E
AMC 046141	GEM 20	210	439			SEC26-T06S-R27E
AMC 046142	GEM 21	210	440			SEC26-T06S-R27E
AMC 046143	GEM 22	210	441			SEC26-T06S-R27E
AMC 046144	GEM 23	210	442			SEC26-T06S-R27E
AMC 046145	GEM 24	210	443			SEC26-T06S-R27E
AMC 046146	GEM 25	210	444			SEC26-T06S-R27E
AMC 046147	GEM 26	210	445			SEC26-T06S-R27E
AMC 046148	GEM 27	210	446			SEC26-T06S-R27E
AMC 046149	GEM 28	210	447			SEC26-T06S-R27E
AMC 046150	GEM 29	210	448			SEC26-T06S-R27E
AMC 046151	GEM 30	210	449			SEC26-T06S-R27E
AMC 046152	GEM 31	210	450			SEC26-T06S-R27E
AMC 046153	GEM 32	210	451			SEC26-T06S-R27E
AMC 046154	GEM 33	210	452			SEC26-T06S-R27E
AMC 046171	GEM 50	210	469			SEC26-T06S-R27E
AMC 046172	GEM 51	210	470			SEC26-T06S-R27E
AMC 046173	GEM 52	210	471			SEC26-T06S-R27E
AMC 046174	GEM 53	210	472			SEC26-T06S-R27E
AMC 046175	GEM 54	210	473			SEC26-T06S-R27E
AMC 046176	GEM 55	210	474			SEC26-T06S-R27E
AMC 046177	GEM 56	210	475			SEC26-T06S-R27E
AMC 046203	GEM 82	210	501			SEC26-T06S-R27E

Date: 6/1/2017

84

RECEIVED  
BLM AZ STATE OFFICE  
PHOENIX, ARIZONA  
JUL 12 A 10:50 2017



## Exhibit A

County: Graham

State: AZ

BLM Serial #	Claim Name	Original Recording		Amended Recording		Location
		Recording #	Page #	Recording #	Page #	
AMC 046204	GEM 83	210	502			SEC26-T06S-R27E
AMC 046205	GEM 84	210	503			SEC26-T06S-R27E
AMC 046206	GEM 85	210	504			SEC26-T06S-R27E
AMC 046207	GEM 86	210	505			SEC26-T06S-R27E
AMC 046208	GEM 87	210	506			SEC26-T06S-R27E
AMC 046209	GEM 88	210	507			SEC26-T06S-R27E
AMC 046210	GEM 89	210	508			SEC26-T06S-R27E
AMC 046211	GEM 90	210	509			SEC26-T06S-R27E
AMC 046212	GEM 91	210	510			SEC26-T06S-R27E
AMC 046213	GEM 92	210	511			SEC26-T06S-R27E
AMC 046214	GEM 93	210	512			SEC26-T06S-R27E
AMC 046215	GEM 94	210	513			SEC26-T06S-R27E
AMC 046216	GEM 95	210	514			SEC26-T06S-R27E
AMC 046217	GEM 96	210	515			SEC26-T06S-R27E
AMC 046218	GEM 97	210	516			SEC26-T06S-R27E
AMC 046219	GEM 98	210	517			SEC26-T06S-R27E
AMC 046220	GEM 99	210	518			SEC26-T06S-R27E
AMC 046221	GEM 100	210	519			SEC26-T06S-R27E
AMC 046222	GEM 101	210	520			SEC26-T06S-R27E
AMC 046223	GEM 102	210	521			SEC26-T06S-R27E
AMC 046224	GEM 103	210	522			SEC26-T06S-R27E
AMC 046225	GEM 104	210	523			SEC26-T06S-R27E
AMC 046226	GEM 105	210	524			SEC26-T06S-R27E
AMC 046227	GEM 106	210	525			SEC26-T06S-R27E
AMC 046228	GEM 107	210	526			SEC26-T06S-R27E
AMC 046229	GEM 108	210	527			SEC26-T06S-R27E
AMC 046230	GEM 109	210	528			SEC26-T06S-R27E
AMC 046231	GEM 110	210	529			SEC26-T06S-R27E
AMC 046232	GEM 111	210	530			SEC26-T06S-R27E
AMC 046233	GEM 112	210	531			SEC26-T06S-R27E
AMC 046234	GEM 113	210	532			SEC23-T06S-R27E
AMC 046235	GEM 114	210	533			SEC23-T06S-R27E
AMC 046236	GEM 115	210	534			SEC23-T06S-R27E
AMC 046237	GEM 116	210	535			SEC23-T06S-R27E
AMC 046238	GEM 117	210	536			SEC25-T06S-R27E
AMC 046239	GEM 118	210	537			SEC25-T06S-R27E
AMC 046240	GEM 119	210	538			SEC25-T06S-R27E
AMC 046241	GEM 120	210	539			SEC25-T06S-R27E

Date: 6/1/2017

RECEIVED  
BLM AZ STATE OFFICE  
PHOENIX, ARIZONA  
2017 JUL 12 A 10:35

## Exhibit A

County: Graham

State: AZ

BLM Serial #	Claim Name	Original Recording		Amended Recording		Location
		Recording #	Page #	Recording #	Page #	
AMC 046242	GEM 121	210	540			SEC25-T06S-R27E
AMC 046243	GEM 122	210	541			SEC25-T06S-R27E
AMC 046244	GEM 123	210	542			SEC25-T06S-R27E
AMC 046245	GEM 124	210	543			SEC25-T06S-R27E
AMC 046246	GEM 125	210	544			SEC25-T06S-R27E
AMC 046247	GEM 126	210	545			SEC25-T06S-R27E
AMC 046248	GEM 127	210	546			SEC25-T06S-R27E
AMC 046249	GEM 128	210	547			SEC25-T06S-R27E
AMC 046250	GEM 129	210	548			SEC25-T06S-R27E
AMC 046251	GEM 130	210	549			SEC25-T06S-R27E
AMC 046252	GEM 131	210	550			SEC25-T06S-R27E
AMC 046253	GEM 132	210	551			SEC25-T06S-R27E
AMC 046254	GEM 133	210	552			SEC25-T06S-R27E
AMC 046255	GEM 134	210	553			SEC25-T06S-R27E
AMC 046256	GEM 135	210	554			SEC25-T06S-R27E
AMC 046257	GEM 136	210	555			SEC25-T06S-R27E
AMC 046258	GEM 137	210	556			SEC25-T06S-R27E
AMC 046259	GEM 138	210	557			SEC25-T06S-R27E
AMC 046260	GEM 139	210	558			SEC25-T06S-R27E
AMC 046261	GEM 140	210	559			SEC25-T06S-R27E
AMC 046262	GEM 141	210	560			SEC25-T06S-R27E
AMC 046263	GEM 142	210	561			SEC25-T06S-R27E
AMC 046264	GEM 143	210	562			SEC25-T06S-R27E
AMC 046265	GEM 144	210	563			SEC25-T06S-R27E
AMC 046266	GEM 145	210	564			SEC25-T06S-R27E
AMC 046267	GEM 146	210	565			SEC25-T06S-R27E
AMC 046268	GEM 147	210	566			SEC25-T06S-R27E
AMC 046269	GEM 148	210	567			SEC25-T06S-R27E
AMC 046270	GEM 149	210	568			SEC25-T06S-R27E
AMC 046271	GEM 150	210	569			SEC25-T06S-R27E
AMC 046272	GEM 151	210	570			SEC25-T06S-R27E
AMC 046273	GEM 152	210	571			SEC25-T06S-R27E
AMC 046274	GEM 153	210	572			SEC25-T06S-R27E
AMC 046275	GEM 154	210	573			SEC25-T06S-R27E
AMC 046276	GEM 155	210	574			SEC25-T06S-R27E
AMC 046277	GEM 156	210	575			SEC25-T06S-R27E
AMC 046278	GEM 157	210	576			SEC25-T06S-R27E
AMC 046279	GEM 158	210	577			SEC25-T06S-R27E

Date: 6/1/2017

38

RECEIVED  
 BLM AZ STATE OFFICE  
 2017 JUL 12 A 10:02  
 PHOENIX, ARIZONA

## Exhibit A

County: Graham

State: AZ

BLM Serial #	Claim Name	Original Recording		Amended Recording		Location
		Recording #	Page #	Recording #	Page #	
AMC 046280	GEM 159	210	578			SEC25-T06S-R27E
AMC 046281	GEM 160	210	579			SEC25-T06S-R27E
AMC 046282	GEM 161	210	580			SEC25-T06S-R27E
AMC 046283	GEM 162	210	581			SEC25-T06S-R27E
AMC 046284	GEM 163	210	582			SEC25-T06S-R27E
AMC 046285	GEM 164	210	583			SEC25-T06S-R27E
AMC 046286	GEM 165	210	584			SEC25-T06S-R27E
AMC 046287	GEM 166	210	585			SEC25-T06S-R27E
AMC 046288	GEM 167	210	586			SEC25-T06S-R27E
AMC 046289	GEM 168	210	587			SEC25-T06S-R27E
AMC 046290	GEM 169	210	588			SEC25-T06S-R27E
AMC 046291	GEM 170	210	589			SEC25-T06S-R27E
AMC 046292	GEM 171	210	590			SEC25-T06S-R27E
AMC 046293	GEM 172	210	591			SEC25-T06S-R27E
AMC 046294	GEM 173	210	592			SEC25-T06S-R27E
AMC 046295	GEM 174	210	593			SEC30-T06S-R28E
AMC 046296	GEM 175	210	594			SEC30-T06S-R28E
AMC 046297	GEM 176	210	595			SEC25-T06S-R27E
AMC 046298	GEM 177	210	596			SEC25-T06S-R27E
AMC 046299	GEM 178	210	597			SEC25-T06S-R27E
AMC 046300	GEM 179	210	598			SEC25-T06S-R27E
AMC 046301	GEM 180	210	599			SEC25-T06S-R27E
AMC 046302	GEM 181	210	600			SEC25-T06S-R27E
AMC 046303	GEM 182	211	1			SEC25-T06S-R27E
AMC 046304	GEM 183	211	2			SEC25-T06S-R27E
AMC 046305	GEM 184	211	3			SEC25-T06S-R27E
AMC 046306	GEM 185	211	4			SEC25-T06S-R27E
AMC 046307	GEM 186	211	5			SEC25-T06S-R27E
AMC 046308	GEM 187	211	6			SEC25-T06S-R27E
AMC 046309	GEM 188	211	7			SEC25-T06S-R27E
AMC 046310	GEM 189	211	8			SEC25-T06S-R27E
AMC 046311	GEM 190	211	9			SEC25-T06S-R27E
AMC 046312	GEM 191	211	10			SEC25-T06S-R27E
AMC 046313	GEM 192	211	11			SEC25-T06S-R27E
AMC 046314	GEM 193	211	12			SEC25-T06S-R27E
AMC 046315	GEM 194	211	13			SEC25-T06S-R27E
AMC 046316	GEM 195	211	14			SEC25-T06S-R27E
AMC 046317	GEM 196	211	15			SEC25-T06S-R27E

Date: 6/1/2017

38

RECEIVED  
 BLM AZ STATE OFFICE  
 2017 JUL 12 A 10:35  
 PHOENIX, ARIZONA

## Exhibit A

County: Graham

State: AZ

BLM Serial #	Claim Name	Original Recording		Amended Recording		Location
		Recording #	Page #	Recording #	Page #	
AMC 067657	Mas No. 9	249	269			SEC27-T06S-R26E
AMC 067658	Mas No. 10	249	270			SEC27-T06S-R26E
AMC 067659	Mas No. 11	249	271			SEC27-T06S-R26E
AMC 067660	Mas No. 12	249	272			SEC27-T06S-R26E
AMC 067661	Mas No. 13	249	273			SEC27-T06S-R26E
AMC 067662	Mas No. 14	249	274			SEC27-T06S-R26E
AMC 067663	Mas No. 15	249	275			SEC27-T06S-R26E
AMC 067664	Mas No. 16	249	276			SEC27-T06S-R26E
AMC 067665	Mas No. 17	249	277			SEC27-T06S-R26E
AMC 067666	Mas No. 18	249	278			SEC27-T06S-R26E
AMC 067667	Mas No. 19	249	279			SEC34-T06S-R26E
AMC 067668	Mas No. 20	249	280			SEC34-T06S-R26E
AMC 067669	Mas No. 21	249	281			SEC34-T06S-R26E
AMC 067670	Mas No. 22	249	282			SEC34-T06S-R26E
AMC 067671	Mas No. 23	249	283			SEC34-T06S-R26E
AMC 067672	Mas No. 24	249	284			SEC34-T06S-R26E
AMC 067673	Mas No. 25	249	285			SEC34-T06S-R26E
AMC 067674	Mas No. 26	249	286			SEC34-T06S-R26E
AMC 067675	Mas No. 27	249	287			SEC34-T06S-R26E
AMC 067676	Mas No. 28	249	288			SEC34-T06S-R26E
AMC 067677	Mas No. 29	249	289			SEC34-T06S-R26E
AMC 067678	Mas No. 30	249	290			SEC34-T06S-R26E
AMC 067679	Mas No. 31	249	291			SEC34-T06S-R26E
AMC 067680	Mas No. 32	249	292			SEC34-T06S-R26E
AMC 067681	Mas No. 33	249	293			SEC34-T06S-R26E
AMC 067682	Mas No. 34	249	294			SEC34-T06S-R26E
AMC 067683	Mas No. 35	249	295			SEC34-T06S-R26E
AMC 067684	Mas No. 36	249	296			SEC34-T06S-R26E
AMC 067685	Mas No. 45	249	297			SEC27-T06S-R26E
AMC 067686	Mas No. 46	249	298			SEC27-T06S-R26E
AMC 067687	Mas No. 47	249	299			SEC27-T06S-R26E
AMC 067688	Mas No. 48	249	300			SEC27-T06S-R26E
AMC 067689	Mas No. 49	249	301			SEC27-T06S-R26E
AMC 067690	Mas No. 50	249	302			SEC27-T06S-R26E
AMC 067691	Mas No. 51	249	303			SEC27-T06S-R26E
AMC 067692	Mas No. 52	249	304			SEC27-T06S-R26E
AMC 067693	Mas No. 53	249	305			SEC27-T06S-R26E
AMC 067694	Mas No. 54	249	306			SEC27-T06S-R26E

Date: 6/1/2017

34

RECEIVED  
 BLM AZ STATE OFFICE  
 JUL 12 10:50 AM '17  
 HOENIX, ARIZONA

## Exhibit A

County: Graham

State: AZ

BLM Serial #	Claim Name	Original Recording		Amended Recording		Location
		Recording #	Page #	Recording #	Page #	
AMC 067695	Mas No. 55	249	307			SEC27-T06S-R26E
AMC 067696	Mas No. 56	249	308			SEC27-T06S-R26E
AMC 067697	Mas No. 57	249	309			SEC27-T06S-R26E
AMC 067698	Mas No. 58	249	310			SEC27-T06S-R26E
AMC 067699	Mas No. 59	249	311			SEC27-T06S-R26E
AMC 067700	Mas No. 60	249	312			SEC27-T06S-R26E
AMC 067701	Mas No. 61	249	313			SEC27-T06S-R26E
AMC 067702	Mas No. 62	249	314			SEC27-T06S-R26E
AMC 067703	Mas No. 63	249	315			SEC27-T06S-R26E
AMC 067704	Mas No. 64	249	316			SEC27-T06S-R26E
AMC 067705	Mas No. 65	249	317			SEC27-T06S-R26E
AMC 067706	Mas No. 66	249	318			SEC27-T06S-R26E
AMC 067707	Mas No. 67	249	319			SEC27-T06S-R26E
AMC 067708	Mas No. 68	249	320			SEC27-T06S-R26E
AMC 067709	Mas No. 69	249	321			SEC27-T06S-R26E
AMC 067710	Mas No. 70	249	322			SEC27-T06S-R26E
AMC 067711	Mas No. 71	249	323			SEC27-T06S-R26E
AMC 067712	Mas No. 72	249	324			SEC34-T06S-R26E
AMC 067713	Mas No. 73	249	325			SEC28-T06S-R26E
AMC 067714	Mas No. 74	249	326			SEC28-T06S-R26E
AMC 067715	Mas No. 75	249	327			SEC28-T06S-R26E
AMC 067716	Mas No. 76	249	328			SEC28-T06S-R26E
AMC 067717	Mas No. 77	249	329			SEC28-T06S-R26E
AMC 067718	Mas No. 78	249	330			SEC28-T06S-R26E
AMC 067719	Mas No. 79	249	331			SEC28-T06S-R26E
AMC 067720	Mas No. 80	249	332			SEC28-T06S-R26E
AMC 067721	Mas No. 81	249	333			SEC28-T06S-R26E
AMC 067722	Mas No. 82	249	334			SEC28-T06S-R26E
AMC 067723	Mas No. 83	249	335			SEC33-T06S-R26E
AMC 067724	Mas No. 84	249	336			SEC33-T06S-R26E
AMC 067725	Mas No. 85	249	337			SEC33-T06S-R26E
AMC 067726	Mas No. 86	249	338			SEC33-T06S-R26E
AMC 067727	Mas No. 87	249	339			SEC33-T06S-R26E
AMC 067728	Mas No. 88	249	340			SEC33-T06S-R26E
AMC 067729	Mas No. 89	249	341			SEC33-T06S-R26E
AMC 067730	Mas No. 90	249	342			SEC33-T06S-R26E
AMC 067731	Mas No. 91	249	343			SEC33-T06S-R26E
AMC 067732	Mas No. 92	249	344			SEC33-T06S-R26E

Date: 6/1/2017

RECEIVED  
BLM AZ STATE OFFICE  
2017 JUL 12 A 10:34  
PHOENIX, ARIZ

## Exhibit A

County: Graham

State: AZ

BLM Serial #	Claim Name	Original Recording		Amended Recording		Location
		Recording #	Page #	Recording #	Page #	
AMC 067733	Mas No. 93	249	345			SEC33-T06S-R26E
AMC 067734	Mas No. 94	249	346			SEC33-T06S-R26E
AMC 067735	Mas No. 96	249	348			SEC33-T06S-R26E
AMC 067736	Mas No. 98	249	349			SEC33-T06S-R26E
AMC 067737	Mas No. 100	249	350			SEC33-T06S-R26E
AMC 067750	Epsilon No. 51	51	38			SEC09-T06S-R27E
AMC 067767	Garoga 16A	46	61	416	972	SEC10-T06S-R27E
AMC 067772	Garoga #21	46	56			SEC10-T06S-R27E
AMC 067773	Garoga #22	46	55			SEC10-T06S-R27E
AMC 067774	Garoga #23	46	54			SEC10-T06S-R27E
AMC 067775	Garoga #24	46	53			SEC10-T06S-R27E
AMC 067776	Garoga #25	46	52			SEC10-T06S-R27E
AMC 067829	Alpha 61A	46	22	420	29	SEC20-T06S-R27E
AMC 067831	Alpha 63A	46	24	420	33	SEC20-T06S-R27E
AMC 067833	Alpha 65A	46	26	420	37	SEC20-T06S-R27E
AMC 067835	Alpha 67A	46	28	420	41	SEC20-T06S-R27E
AMC 067837	Alpha #69	46	30			SEC20-T06S-R27E
AMC 067839	Alpha #71	46	32			SEC20-T06S-R27E
AMC 067841	Alpha #73	46	34			SEC20-T06S-R27E
AMC 101253	Ace 19A	324	272	414	31	SEC14-T06S-R26E
AMC 101254	Ace 20A	324	274	414	33	SEC14-T06S-R26E
AMC 101282	Ace 48A	324	330	410	397	SEC11-T06S-R26E
AMC 101283	Ace 49A	324	332	410	399	SEC11-T06S-R26E
AMC 101284	Ace 50A	324	334	410	401	SEC11-T06S-R26E
AMC 101285	Ace 51A	324	336	478	241	SEC11-T06S-R26E
AMC 101286	Ace 52A	324	338	478	243	SEC11-T06S-R26E
AMC 113312	Melody #2A	332	595			SEC11-T06S-R26E
AMC 113313	Melody #4A	332	596			SEC11-T06S-R26E
AMC 113314	Melody #6A	332	597			SEC11-T06S-R26E
AMC 113315	Melody #12A	332	598			SEC11-T06S-R26E
AMC 113316	Melody #14A	332	599			SEC11-T06S-R26E
AMC 113317	Melody #22A	332	600			SEC11-T06S-R26E
AMC 113318	Melody #24A	332	601			SEC11-T06S-R26E
AMC 113319	Melody #26A	332	602			SEC11-T06S-R26E
AMC 113320	Melody #28A	332	603			SEC11-T06S-R26E
AMC 113321	Melody #30A	332	604			SEC11-T06S-R26E
AMC 288506	GEM 252	409	77			SEC36-T06S-R27E
AMC 288507	GEM 253	409	79			SEC36-T06S-R27E

Date: 6/1/2017

38

RECEIVED  
BLM AZ STATE OFFICE  
2017 JUL 12 A 10:00  
PHOENIX, ARIZ

## Exhibit A

County: Graham

State: AZ

BLM Serial #	Claim Name	Original Recording		Amended Recording		Location
		Recording #	Page #	Recording #	Page #	
AMC 288508	GEM 254	409	80			SEC36-T06S-R27E
AMC 288509	GEM 255	409	81			SEC36-T06S-R27E
AMC 288510	GEM 256	409	82			SEC36-T06S-R27E
AMC 288511	GEM 257	409	83			SEC36-T06S-R27E
AMC 288512	GEM 258	409	84			SEC36-T06S-R27E
AMC 288513	GEM 259	409	85			SEC36-T06S-R27E
AMC 288514	GEM 260	409	86			SEC36-T06S-R27E
AMC 288515	GEM 261	409	87			SEC36-T06S-R27E
AMC 288516	GEM 262	409	88			SEC36-T06S-R27E
AMC 288517	GEM 263	409	89			SEC36-T06S-R27E
AMC 288518	GEM 264	409	90			SEC36-T06S-R27E
AMC 288519	GEM 265	409	91			SEC36-T06S-R27E
AMC 288520	GEM 266	409	92			SEC36-T06S-R27E
AMC 288521	GEM 267	409	93			SEC36-T06S-R27E
AMC 288522	GEM 268	409	94			SEC36-T06S-R27E
AMC 288523	GEM 269	409	95			SEC36-T06S-R27E
AMC 288524	GEM 270	409	96			SEC36-T06S-R27E
AMC 288525	GEM 271	409	97			SEC36-T06S-R27E
AMC 288526	GEM 272	409	98			SEC36-T06S-R27E
AMC 288527	GEM 273	409	99			SEC36-T06S-R27E
AMC 288528	GEM 274	409	100			SEC36-T06S-R27E
AMC 288529	GEM 275	409	101			SEC36-T06S-R27E
AMC 289500	LS-21	410	379			SEC14-T06S-R26E
AMC 289501	LS-22	410	381			SEC11-T06S-R26E
AMC 292727	AZCO #1 Amended	413	128	512	669	SEC33-T06S-R27E
AMC 292728	AZCO #2 Amended	413	130	512	671	SEC04-T07S-R27E
AMC 292729	AZCO #3 Amended	413	132	512	673	SEC33-T06S-R27E
AMC 292730	AZCO #4 Amended	413	134	512	675	SEC04-T07S-R27E
AMC 292731	AZCO #5 Amended	413	136	512	677	SEC33-T06S-R27E
AMC 292732	AZCO #6 Amended	413	138	512	679	SEC04-T07S-R27E
AMC 292733	AZCO #7 Amended	413	140	512	681	SEC33-T06S-R27E
AMC 292734	AZCO #8 Amended	413	142	512	683	SEC04-T07S-R27E
AMC 292735	AZCO #9 Amended	413	144	512	685	SEC33-T06S-R27E
AMC 292736	AZCO #10 Amended	413	146	512	687	SEC04-T07S-R27E
AMC 292737	AZCO #11 Amended	413	148	512	689	SEC33-T06S-R27E
AMC 292738	AZCO #12 Amended	413	150	512	691	SEC04-T07S-R27E
AMC 292739	AZCO #13 Amended	413	152	512	693	SEC33-T06S-R27E
AMC 292740	AZCO #14 Amended	413	154	512	695	SEC04-T07S-R27E

Date: 6/1/2017

RECEIVED  
BLM AZ STATE OFFICE  
PHOENIX, ARIZ  
2017 JUN 12 A 10:55

## Exhibit A

County: Graham

State: AZ

<u>BLM Serial #</u>	<u>Claim Name</u>	<u>Original Recording</u>		<u>Amended Recording</u>		<u>Location</u>
		<u>Recording #</u>	<u>Page #</u>	<u>Recording #</u>	<u>Page #</u>	
AMC 292741	AZCO #15 Amended	413	156	512	697	SEC33-T06S-R27E
AMC 292742	AZCO #16 Amended	413	158	512	699	SEC04-T07S-R27E
AMC 292743	AZCO #17 Amended	413	160	512	701	SEC33-T06S-R27E
AMC 292744	AZCO #18 Amended	413	162	512	703	SEC04-T07S-R27E
AMC 292759	AZCO #33 Amended	413	192	512	705	SEC33-T06S-R27E
AMC 292760	AZCO #34 Amended	413	194	512	707	SEC33-T06S-R27E
AMC 292761	AZCO #35 Amended	413	196	512	709	SEC33-T06S-R27E
AMC 292762	AZCO #36 Amended	413	198	512	711	SEC33-T06S-R27E
AMC 292763	AZCO #37 Amended	413	200	512	713	SEC33-T06S-R27E
AMC 292764	AZCO #38 Amended	413	202	512	715	SEC33-T06S-R27E
AMC 292765	AZCO #100 Amended	413	204	512	731	SEC33-T06S-R27E
AMC 292766	AZCO #101 Amended	413	206	512	733	SEC33-T06S-R27E
AMC 292767	AZCO #102 Amended	413	208	512	735	SEC33-T06S-R27E
AMC 292768	AZCO #103 Amended	413	210	512	737	SEC33-T06S-R27E
AMC 292769	AZCO #104 Amended	413	212	512	739	SEC33-T06S-R27E
AMC 292770	AZCO #105 Amended	413	214	512	741	SEC33-T06S-R27E
AMC 292771	AZCO #106 Amended	413	216	512	743	SEC33-T06S-R27E
AMC 292772	AZCO #107 Amended	413	218	512	745	SEC33-T06S-R27E
AMC 292773	AZCO #108 Amended	413	220	512	747	SEC33-T06S-R27E
AMC 292774	AZCO #109 Amended	413	222	512	749	SEC33-T06S-R27E
AMC 292775	AZCO #110 Amended	413	224	512	751	SEC33-T06S-R27E
AMC 292776	AZCO #111 Amended	413	226	512	753	SEC33-T06S-R27E
AMC 292777	AZCO #112 Amended	413	228	512	755	SEC33-T06S-R27E
AMC 292778	AZCO #113 Amended	413	230	512	757	SEC33-T06S-R27E
AMC 292791	AZCO #126 Amended	413	256	512	759	SEC27-T06S-R27E
AMC 292792	AZCO #127 Amended	413	258	512	761	SEC27-T06S-R27E
AMC 292793	AZCO #128 Amended	413	260	512	763	SEC34-T06S-R27E
AMC 292794	AZCO #129 Amended	413	262	512	765	SEC34-T06S-R27E
AMC 292795	AZCO #130 Amended	413	264	512	767	SEC34-T06S-R27E
AMC 292796	AZCO #131 Amended	413	266	512	769	SEC34-T06S-R27E
AMC 292797	AZCO #132 Amended	413	268	512	771	SEC34-T06S-R27E
AMC 292798	AZCO #133 Amended	413	270	512	773	SEC34-T06S-R27E
AMC 292799	AZCO #134 Amended	413	272	512	775	SEC34-T06S-R27E
AMC 292800	AZCO #135 Amended	413	274	512	777	SEC34-T06S-R27E
AMC 292801	AZCO #136 Amended	413	276	512	779	SEC34-T06S-R27E
AMC 292802	AZCO #137 Amended	413	278	512	781	SEC34-T06S-R27E
AMC 292803	AZCO #138 Amended	413	280	512	783	SEC34-T06S-R27E
AMC 292804	AZCO #139 Amended	413	282	512	785	SEC34-T06S-R27E

Date: 6/1/2017

RECEIVED  
BLM AZ STATE OFFICE  
JUL 12 2017  
PHOENIX, ARIZONA



## Exhibit A

County: Graham

State: AZ

BLM Serial #	Claim Name	Original Recording		Amended Recording		Location
		Recording #	Page #	Recording #	Page #	
AMC 292809	AZCO #144 Amended	413	292	512	787	SEC34-T06S-R27E
AMC 292810	AZCO #145 Amended	413	294	512	789	SEC34-T06S-R27E
AMC 292811	AZCO #146 Amended	413	296	512	791	SEC34-T06S-R27E
AMC 292812	AZCO #147 Amended	413	298	512	793	SEC34-T06S-R27E
AMC 292820	AZCO #155 Amended	413	314	512	795	SEC28-T06S-R27E
AMC 292822	AZCO #157 Amended	413	318	512	797	SEC28-T06S-R27E
AMC 292824	AZCO #159 Amended	413	322	512	799	SEC28-T06S-R27E
AMC 292826	AZCO #161 Amended	413	326	512	801	SEC28-T06S-R27E
AMC 292828	AZCO #163 Amended	413	330	512	803	SEC27-T06S-R27E
AMC 292829	AZCO #164 Amended	413	332	512	805	SEC27-T06S-R27E
AMC 292830	AZCO #165 Amended	413	334	512	807	SEC27-T06S-R27E
AMC 292831	AZCO #166 Amended	413	336	512	809	SEC27-T06S-R27E
AMC 292832	AZCO #167 Amended	413	338	512	811	SEC27-T06S-R27E
AMC 292833	AZCO #168 Amended	413	340	512	813	SEC27-T06S-R27E
AMC 292834	AZCO #169 Amended	413	342	512	815	SEC27-T06S-R27E
AMC 292835	AZCO #170 Amended	413	344	512	817	SEC27-T06S-R27E
AMC 292836	AZCO #171 Amended	413	346	512	819	SEC27-T06S-R27E
AMC 292837	AZCO #172 Amended	413	348	512	821	SEC27-T06S-R27E
AMC 292838	AZCO #173 Amended	413	350	512	823	SEC27-T06S-R27E
AMC 292839	AZCO #174 Amended	413	352	512	825	SEC27-T06S-R27E
AMC 292840	AZCO #175 Amended	413	354	512	827	SEC27-T06S-R27E
AMC 292841	AZCO #176 Amended	413	356	512	829	SEC27-T06S-R27E
AMC 292842	AZCO #177 Amended	413	358	512	831	SEC27-T06S-R27E
AMC 292843	AZCO #178 Amended	413	360	512	833	SEC27-T06S-R27E
AMC 292844	AZCO #179 Amended	413	362	512	835	SEC27-T06S-R27E
AMC 292845	AZCO #180 Amended	413	364	512	837	SEC26-T06S-R27E
AMC 292846	AZCO #181 Amended	413	366	512	839	SEC26-T06S-R27E
AMC 292847	AZCO #182 Amended	413	368	512	841	SEC26-T06S-R27E
AMC 292848	AZCO #183 Amended	413	370	512	843	SEC26-T06S-R27E
AMC 292850	AZCO #195 Amended	413	374	512	857	SEC27-T06S-R27E
AMC 292851	AZCO #196 Amended	413	376	512	859	SEC26-T06S-R27E
AMC 292852	AZCO #197 Amended	413	378	512	861	SEC26-T06S-R27E
AMC 292853	AZCO #198 Amended	413	380	512	863	SEC26-T06S-R27E
AMC 292856	AZCO #202 Amended	413	386	512	865	SEC35-T06S-R27E
AMC 293498	LS-36	414	51			SEC14-T06S-R26E
AMC 294150	AZCO #39 Amended	415	9	512	717	SEC33-T06S-R27E
AMC 294151	AZCO #40 Amended	415	11	512	719	SEC33-T06S-R27E
AMC 294152	AZCO #41 Amended	415	13	512	721	SEC33-T06S-R27E

Date: 6/1/2017

RECEIVED  
BLM AZ STATE OFFICE  
2017 JUL 12 A 10:36  
PHOENIX, ARIZONA

## Exhibit A

County: Graham

State: AZ

Original Recording

Amended Recording

BLM Serial #	Claim Name	Original Recording		Amended Recording		Location
		Recording #	Page #	Recording #	Page #	
AMC 294153	AZCO #42 Amended	415	15	512	723	SEC33-T06S-R27E
AMC 294154	AZCO #43 Amended	415	17	512	725	SEC28-T06S-R27E
AMC 294155	AZCO #203 Amended	415	19	512	867	SEC28-T06S-R27E
AMC 294157	AZCO #205 Amended	415	23	512	869	SEC28-T06S-R27E
AMC 294159	AZCO #207 Amended	415	27	512	871	SEC28-T06S-R27E
AMC 294161	AZCO #209 Amended	415	31	512	873	SEC28-T06S-R27E
AMC 294167	AZCO #357 Amended	415	135	512	889	SEC24-T06S-R27E
AMC 294168	AZCO #359 Amended	415	137	512	893	SEC24-T06S-R27E
AMC 294169	AZCO #361 Amended	415	139	512	897	SEC24-T06S-R27E
AMC 294170	AZCO #363 Amended	415	141	512	901	SEC24-T06S-R27E
AMC 294171	AZCO #364 Amended	415	143	512	903	SEC24-T06S-R27E
AMC 294172	AZCO #365 Amended	415	145	512	905	SEC24-T06S-R27E
AMC 294173	AZCO #366 Amended	415	147	512	907	SEC24-T06S-R27E
AMC 294174	AZCO #367 Amended	415	149	512	909	SEC23-T06S-R27E
AMC 294175	AZCO #368 Amended	415	151	512	911	SEC23-T06S-R27E
AMC 294176	AZCO #369 Amended	415	153	512	913	SEC23-T06S-R27E
AMC 294177	AZCO #370 Amended	415	155	512	915	SEC23-T06S-R27E
AMC 294178	AZCO #371 Amended	415	157	512	917	SEC23-T06S-R27E
AMC 294179	AZCO #372 Amended	415	159	512	919	SEC23-T06S-R27E
AMC 294180	AZCO #373 Amended	415	161	512	921	SEC23-T06S-R27E
AMC 294181	AZCO #374 Amended	415	163	512	923	SEC23-T06S-R27E
AMC 294182	AZCO #375 Amended	415	165	512	925	SEC23-T06S-R27E
AMC 294183	AZCO #376 Amended	415	167	512	927	SEC23-T06S-R27E
AMC 294184	AZCO #377 Amended	415	169	512	929	SEC23-T06S-R27E
AMC 294185	AZCO #378 Amended	415	171	512	931	SEC23-T06S-R27E
AMC 294186	AZCO #379 Amended	415	173	512	933	SEC23-T06S-R27E
AMC 294187	AZCO #380 Amended	415	175	512	935	SEC23-T06S-R27E
AMC 294188	AZCO #381 Amended	415	177	512	937	SEC26-T06S-R27E
AMC 294189	AZCO #382 Amended	415	179	512	939	SEC26-T06S-R27E
AMC 294190	AZCO #383 Amended	415	181	512	941	SEC26-T06S-R27E
AMC 294191	AZCO #384 Amended	415	183	512	943	SEC26-T06S-R27E
AMC 294192	AZCO #300 Amended	415	43	512	875	SEC30-T06S-R27E
AMC 294193	AZCO #301 Amended	415	45	512	877	SEC30-T06S-R27E
AMC 294194	AZCO #302 Amended	415	47	512	879	SEC25-T06S-R27E
AMC 294195	AZCO #303 Amended	415	49	512	881	SEC25-T06S-R27E
AMC 294196	AZCO #304 Amended	415	51	512	883	SEC25-T06S-R27E
AMC 294197	AZCO #305 Amended	415	53	512	885	SEC30-T06S-R27E
AMC 294198	AZCO #306 Amended	415	55	512	887	SEC30-T06S-R27E

Date: 6/1/2017

RECEIVED  
BLM AZ STATE OFFICE  
JUL 12 2017

## Exhibit A

County: Graham

State: AZ

BLM Serial #	Claim Name	Original Recording		Amended Recording		Location
		Recording #	Page #	Recording #	Page #	
AMC 294348	LS-39	415	305			SEC31-T05S-R27E
AMC 294349	LS-40	415	319			SEC31-T05S-R27E
AMC 294350	LS-41	415	303			SEC31-T05S-R27E
AMC 298852	LS-53	419	998			SEC20-T06S-R27E
AMC 298855	LS-56	420	5			SEC20-T06S-R27E
AMC 298861	AZCO #44 Amended	419	636	512	727	SEC34-T06S-R27E
AMC 298862	AZCO #45 Amended	419	638	512	729	SEC34-T06S-R27E
AMC 298867	AZCO #185 Amended	419	634	512	845	SEC26-T06S-R27E
AMC 298868	AZCO #400 Amended	419	616	512	945	SEC36-T06S-R27E
AMC 298870	AZCO #402 Amended	419	620	512	947	SEC36-T06S-R27E
AMC 298876	AZCO #410 Amended	419	632	512	949	SEC36-T06S-R27E
AMC 298877	AZCO #411 Amended	419	648	512	951	SEC29-T06S-R27E
AMC 298878	AZCO #412 Amended	419	650	512	953	SEC29-T06S-R27E
AMC 298879	AZCO #413 Amended	419	652	512	955	SEC29-T06S-R27E
AMC 298880	AZCO #414 Amended	419	654	512	957	SEC29-T06S-R27E
AMC 298881	AZCO #415 Amended	419	656	512	959	SEC29-T06S-R27E
AMC 298882	AZCO #416 Amended	419	658	512	961	SEC29-T06S-R27E
AMC 298883	AZCO #417 Amended	419	660	512	963	SEC29-T06S-R27E
AMC 298884	AZCO #418 Amended	419	662	512	965	SEC29-T06S-R27E
AMC 298885	AZCO #419 Amended	419	664	512	967	SEC29-T06S-R27E
AMC 298886	AZCO #420 Amended	419	666	512	969	SEC29-T06S-R27E
AMC 298887	AZCO #421 Amended	419	668	512	971	SEC29-T06S-R27E
AMC 298888	AZCO #422 Amended	419	670	512	973	SEC29-T06S-R27E
AMC 298889	AZCO #423 Amended	419	672	512	975	SEC29-T06S-R27E
AMC 298890	AZCO #424 Amended	419	674	512	977	SEC29-T06S-R27E
AMC 298891	AZCO #425 Amended	419	676	512	979	SEC29-T06S-R27E
AMC 298892	AZCO #426 Amended	419	678	512	981	SEC29-T06S-R27E
AMC 298893	AZCO #427 Amended	419	680	512	983	SEC29-T06S-R27E
AMC 298894	AZCO #428 Amended	419	682	512	985	SEC29-T06S-R27E
AMC 298895	AZCO #429 Amended	419	684	512	987	SEC29-T06S-R27E
AMC 298896	AZCO #430 Amended	419	686	512	989	SEC29-T06S-R27E
AMC 298897	AZCO #461 Amended	419	708	513	11	SEC28-T06S-R27E
AMC 298898	AZCO #462 Amended	419	710	513	13	SEC28-T06S-R27E
AMC 298899	AZCO #463 Amended	419	712	513	15	SEC28-T06S-R27E
AMC 298929	AZCO #190 Amended	419	818	512	847	SEC27-T06S-R27E
AMC 298930	AZCO #191 Amended	419	820	512	849	SEC27-T06S-R27E
AMC 298931	AZCO #192 Amended	419	822	512	851	SEC27-T06S-R27E
AMC 298932	AZCO #193 Amended	419	824	512	853	SEC27-T06S-R27E

Date: 6/1/2017

RECEIVED  
BLM AZ STATE OFFICE  
2017 JUL 12 A 10  
PHOENIX, ARIZ

## Exhibit A

County: Graham

State: AZ

BLM Serial #	Claim Name	Original Recording		Amended Recording		Location
		Recording #	Page #	Recording #	Page #	
AMC 298933	AZCO #194 Amended	419	826	512	855	SEC27-T06S-R27E
AMC 298934	AZCO #358 Amended	419	828	512	891	SEC24-T06S-R27E
AMC 298935	AZCO #360 Amended	419	830	512	895	SEC24-T06S-R27E
AMC 298936	AZCO #362 Amended	419	832	512	899	SEC24-T06S-R27E
AMC 305755	AZCO #441 Amended	426	703	512	991	SEC29-T06S-R27E
AMC 305756	AZCO #442 Amended	426	705	512	993	SEC29-T06S-R27E
AMC 305757	AZCO #443 Amended	426	707	512	995	SEC29-T06S-R27E
AMC 305758	AZCO #444 Amended	426	709	512	997	SEC21-T06S-R27E
AMC 305759	AZCO #445 Amended	426	711	512	999	SEC20-T06S-R27E
AMC 305760	AZCO #446 Amended	426	713	513	1	SEC20-T06S-R27E
AMC 305761	AZCO #447 Amended	426	715	513	03	SEC20-T06S-R27E
AMC 305762	AZCO #448 Amended	426	717	513	05	SEC20-T06S-R27E
AMC 305763	AZCO #449 Amended	426	719	513	07	SEC20-T06S-R27E
AMC 305764	AZCO #450 Amended	426	721	513	09	SEC20-T06S-R27E
AMC 321860	M1	448	441			SEC15-T06S-R27E
AMC 321861	M2	448	443			SEC15-T06S-R27E
AMC 321862	M3	448	445			SEC15-T06S-R27E
AMC 321863	M4	448	447			SEC15-T06S-R27E
AMC 321864	M5	448	449			SEC15-T06S-R27E
AMC 321865	M6	448	451			SEC15-T06S-R27E
AMC 321866	M7	448	453			SEC15-T06S-R27E
AMC 321867	M8	448	455			SEC15-T06S-R27E
AMC 321868	M9	448	457			SEC15-T06S-R27E
AMC 321869	M10	448	459			SEC15-T06S-R27E
AMC 321870	M11	448	461			SEC15-T06S-R27E
AMC 321871	M12	448	463			SEC15-T06S-R27E
AMC 321872	M13	448	465			SEC15-T06S-R27E
AMC 321873	M14	448	467			SEC15-T06S-R27E
AMC 321874	M15	448	469			SEC15-T06S-R27E
AMC 321875	M16	448	471			SEC15-T06S-R27E
AMC 321876	M17	448	473			SEC15-T06S-R27E
AMC 321877	M18	448	475			SEC15-T06S-R27E
AMC 321878	M37	448	477			SEC10-T06S-R27E
AMC 321879	M38	448	479			SEC10-T06S-R27E
AMC 321880	M39	448	481			SEC15-T06S-R27E
AMC 321881	M40	448	483			SEC15-T06S-R27E
AMC 321882	M41	448	485			SEC15-T06S-R27E
AMC 321883	M42	448	487			SEC15-T06S-R27E

Date: 6/1/2017

RECEIVED  
BLM AZ STATE OFFICE  
JUL 12 2017 10:48 AM  
PHOENIX, ARIZONA

## Exhibit A

County: Graham

State: AZ

BLM Serial #	Claim Name	Original Recording		Amended Recording		Location
		Recording #	Page #	Recording #	Page #	
AMC 321884	M43	448	489			SEC15-T06S-R27E
AMC 321885	M44	448	491			SEC15-T06S-R27E
AMC 321886	M45	448	493			SEC15-T06S-R27E
AMC 321887	M46	448	495			SEC15-T06S-R27E
AMC 321888	M47	448	497			SEC15-T06S-R27E
AMC 321889	M48	448	499			SEC15-T06S-R27E
AMC 321890	M49	448	501			SEC15-T06S-R27E
AMC 321891	M50	448	503			SEC15-T06S-R27E
AMC 321892	M51	448	505			SEC15-T06S-R27E
AMC 321893	M52	448	507			SEC15-T06S-R27E
AMC 321894	M53	448	509			SEC15-T06S-R27E
AMC 321895	M54	448	511			SEC15-T06S-R27E
AMC 321896	M73	448	513			SEC10-T06S-R27E
AMC 321897	M74	448	515			SEC10-T06S-R27E
AMC 321898	M75	448	517			SEC10-T06S-R27E
AMC 321899	M76	448	519			SEC10-T06S-R27E
AMC 321900	M77	448	521			SEC10-T06S-R27E
AMC 321901	M78	448	523			SEC10-T06S-R27E
AMC 321902	M79	448	525			SEC10-T06S-R27E
AMC 321903	M80	448	527			SEC10-T06S-R27E
AMC 321904	M81	448	529			SEC10-T06S-R27E
AMC 321905	M82	448	531			SEC10-T06S-R27E
AMC 321906	M83	448	533			SEC10-T06S-R27E
AMC 321907	M84	448	535			SEC10-T06S-R27E
AMC 321908	M85	448	537			SEC10-T06S-R27E
AMC 321909	M86	448	539			SEC10-T06S-R27E
AMC 321910	M87	448	541			SEC11-T06S-R27E
AMC 321911	M88	448	543			SEC11-T06S-R27E
AMC 321912	M89	448	545			SEC11-T06S-R27E
AMC 321913	M90	448	547			SEC11-T06S-R27E
AMC 321914	M91	448	549			SEC11-T06S-R27E
AMC 321915	M92	448	551			SEC11-T06S-R27E
AMC 321916	M93	448	553			SEC11-T06S-R27E
AMC 321917	M94	448	555			SEC11-T06S-R27E
AMC 321918	M95	448	557			SEC11-T06S-R27E
AMC 321919	M96	448	559			SEC11-T06S-R27E
AMC 321920	M97	448	561			SEC11-T06S-R27E
AMC 321921	M98	448	563			SEC11-T06S-R27E

Date: 6/1/2017

RECEIVED  
BLM AZ STATE OFFICE  
JUL 12 10 12 AM '17  
PHOENIX, ARIZONA

## Exhibit A

County: Graham

State: AZ

<u>BLM Serial #</u>	<u>Claim Name</u>	<u>Original Recording</u>		<u>Amended Recording</u>		<u>Location</u>
		<u>Recording #</u>	<u>Page #</u>	<u>Recording #</u>	<u>Page #</u>	
AMC 321922	M99	448	565			SEC11-T06S-R27E
AMC 321923	M100	448	567			SEC11-T06S-R27E
AMC 321924	M101	448	569			SEC11-T06S-R27E
AMC 321925	M102	448	571			SEC11-T06S-R27E
AMC 321926	M103	448	573			SEC11-T06S-R27E
AMC 321927	M104	448	575			SEC11-T06S-R27E
AMC 321928	M105	448	577			SEC10-T06S-R27E
AMC 321929	M106	448	579			SEC10-T06S-R27E
AMC 321930	M107	448	581			SEC10-T06S-R27E
AMC 321931	M108	448	583			SEC10-T06S-R27E
AMC 321932	M109	448	585			SEC10-T06S-R27E
AMC 321933	M110	448	587			SEC11-T06S-R27E
AMC 321934	M111	448	589			SEC11-T06S-R27E
AMC 321935	M112	448	591			SEC11-T06S-R27E
AMC 321936	M113	448	593			SEC11-T06S-R27E
AMC 321937	M114	448	595			SEC11-T06S-R27E
AMC 321938	M115	448	597			SEC11-T06S-R27E
AMC 321939	M116	448	599			SEC11-T06S-R27E
AMC 321940	M117	448	601			SEC11-T06S-R27E
AMC 321941	M118	448	603			SEC11-T06S-R27E
AMC 321942	M119	448	605			SEC10-T06S-R27E
AMC 321943	M120	448	607			SEC10-T06S-R27E
AMC 321944	M121	448	609			SEC11-T06S-R27E
AMC 321945	M122	448	611			SEC11-T06S-R27E
AMC 321946	M123	448	613			SEC11-T06S-R27E
AMC 321947	M124	448	615			SEC11-T06S-R27E
AMC 324229	M56	452	54			SEC11-T06S-R27E
AMC 324230	M58	452	56			SEC14-T06S-R27E
AMC 324231	M60	452	58			SEC11-T06S-R27E
AMC 324232	M62	452	60			SEC11-T06S-R27E
AMC 324233	M64	452	62			SEC11-T06S-R27E
AMC 324234	M66	452	64			SEC11-T06S-R27E
AMC 324235	M68	452	66			SEC11-T06S-R27E
AMC 324236	M70	452	68			SEC11-T06S-R27E
AMC 324237	M72	452	70			SEC11-T06S-R27E
AMC 324367	AZCO #465 Amended	449	937	513	17	SEC28-T06S-R27E
AMC 324368	AZCO #466 Amended	449	939	513	21	SEC28-T06S-R27E
AMC 324369	AZCO #467 Amended	449	941	513	21	SEC28-T06S-R27E

Date: 6/1/2017

RECEIVED  
BLM AZ STATE OFFICE  
PHOENIX, ARIZONA  
JUL 19 2017

## Exhibit A

County: Graham

State: AZ

BLM Serial #	Claim Name	Original Recording		Amended Recording		Location
		Recording #	Page #	Recording #	Page #	
AMC 324370	AZCO #468 Amended	449	943	513	23	SEC28-T06S-R27E
AMC 324371	AZCO #469 Amended	449	945	513	25	SEC21-T06S-R27E
AMC 324892	MG 121	453	901			SEC30-T05S-R26E
AMC 324893	MG 122	453	903			SEC30-T05S-R26E
AMC 324894	MG 123	453	905			SEC30-T05S-R26E
AMC 324895	MG 124	453	907			SEC30-T05S-R26E
AMC 324896	MG 125	453	909			SEC30-T05S-R26E
AMC 324897	MG 126	453	911			SEC30-T05S-R26E
AMC 324898	MG 127	453	913			SEC30-T05S-R26E
AMC 324899	MG 128	453	915			SEC30-T05S-R26E
AMC 324900	MG 129	453	917			SEC30-T05S-R26E
AMC 324901	MG 130	453	919			SEC30-T05S-R26E
AMC 324902	MG 179	453	933			SEC25-T05S-R25E
AMC 324903	MG 180	453	935			SEC25-T05S-R25E
AMC 324904	MG 181	453	937			SEC25-T05S-R25E
AMC 324905	MG 182	453	939			SEC25-T05S-R25E
AMC 324906	MG 183	453	941			SEC25-T05S-R25E
AMC 324907	MG 184	453	943			SEC25-T05S-R25E
AMC 324908	MG 185	453	945			SEC25-T05S-R25E
AMC 324909	MG 186	453	947			SEC25-T05S-R25E
AMC 324910	MG 187	453	949			SEC25-T05S-R25E
AMC 324911	MG 188	453	951			SEC25-T05S-R25E
AMC 324912	MG 189	453	953			SEC25-T05S-R25E
AMC 324913	MG 190	453	955			SEC25-T05S-R25E
AMC 324914	MG 191	453	957			SEC25-T05S-R25E
AMC 324915	MG 192	453	959			SEC25-T05S-R25E
AMC 324916	MG 193	453	961			SEC25-T05S-R25E
AMC 324917	MG 194	453	963			SEC25-T05S-R25E
AMC 324918	MG 195	453	965			SEC25-T05S-R25E
AMC 324919	MG 196	453	967			SEC25-T05S-R25E
AMC 324920	MG 223	453	969			SEC25-T05S-R25E
AMC 324921	MG 224	453	971			SEC25-T05S-R25E
AMC 324922	MG 225	453	973			SEC25-T05S-R25E
AMC 324923	MG 226	453	975			SEC25-T05S-R25E
AMC 324924	MG 227	453	977			SEC25-T05S-R25E
AMC 324925	MG 228	453	979			SEC25-T05S-R25E
AMC 324926	MG 229	453	981			SEC25-T05S-R25E
AMC 324927	MG 230	453	983			SEC25-T05S-R25E

Date: 6/1/2017

RECEIVED  
BLM AZ STATE OFFICE  
JUL 12 10 10 AM '17  
PHOENIX, ARIZONA

## Exhibit A

County: Graham

State: AZ

BLM Serial #	Claim Name	Original Recording		Amended Recording		Location
		Recording #	Page #	Recording #	Page #	
AMC 324928	MG 231	453	985			SEC25-T05S-R25E
AMC 324929	MG 232	453	987			SEC25-T05S-R25E
AMC 324930	MG 233	453	989			SEC25-T05S-R25E
AMC 324931	MG 234	453	991			SEC25-T05S-R25E
AMC 324932	MG 235	453	993			SEC25-T05S-R25E
AMC 324933	MG 236	453	995			SEC25-T05S-R25E
AMC 324934	MG 237	453	997			SEC25-T05S-R25E
AMC 324935	MG 238	453	999			SEC25-T05S-R25E
AMC 324936	MG 239	454	1			SEC25-T05S-R25E
AMC 324937	MG 240	454	2A			SEC25-T05S-R25E
AMC 326065	SOB 1	458	703			SEC27-T06S-R27E
AMC 326066	SOB 2	458	704			SEC27-T06S-R27E
AMC 326067	SOB 3	458	705			SEC27-T06S-R27E
AMC 326068	SOB 4	458	706			SEC27-T06S-R27E
AMC 326069	SOB 5	458	707			SEC27-T06S-R27E
AMC 326070	SOB 6	458	708			SEC27-T06S-R27E
AMC 326071	SOB 7	458	709			SEC27-T06S-R27E
AMC 326072	SOB 8	458	710			SEC27-T06S-R27E
AMC 326073	SOB 9	458	711			SEC27-T06S-R27E
AMC 326074	SOB 10	458	712			SEC27-T06S-R27E
AMC 326075	SOB 11	458	713			SEC27-T06S-R27E
AMC 326076	SOB 12	458	714			SEC27-T06S-R27E
AMC 326077	SOB 13	458	715			SEC29-T06S-R27E
AMC 326078	SOB 14	458	716			SEC29-T06S-R27E
AMC 326079	SOB 15	458	717			SEC29-T06S-R27E
AMC 326080	SOB 16	458	718			SEC29-T06S-R27E
AMC 326081	SOB 17	458	719			SEC29-T06S-R27E
AMC 326082	SOB 18	458	720			SEC29-T06S-R27E
AMC 326083	SOB 19	458	721			SEC20-T06S-R27E
AMC 326084	SOB 20	458	722			SEC20-T06S-R27E
AMC 326085	SOB 21	458	723			SEC20-T06S-R27E
AMC 326086	SOB 22	458	724			SEC20-T06S-R27E
AMC 326087	SOB 23	458	725			SEC29-T06S-R27E
AMC 326088	SOB 24	458	726			SEC29-T06S-R27E
AMC 326089	SOB 25	458	727			SEC29-T06S-R27E
AMC 326090	SOB 26	458	728			SEC29-T06S-R27E
AMC 326091	SOB 27	458	729			SEC29-T06S-R27E
AMC 326092	SOB 28	458	730			SEC29-T06S-R27E

Date: 6/1/2017

RECEIVED  
BLM AZ STATE OFFICE  
JUL 12 2017  
PHOENIX, ARIZ

Page 19



## Exhibit A

County: Graham

State: AZ

BLM Serial #	Claim Name	Original Recording		Amended Recording		Location
		Recording #	Page #	Recording #	Page #	
AMC 326093	SOB 29	458	731			SEC29-T06S-R27E
AMC 326094	SOB 30	458	732			SEC29-T06S-R27E
AMC 326095	SOB 31	458	733			SEC29-T06S-R27E
AMC 326096	SOB 32	458	734			SEC29-T06S-R27E
AMC 326097	SOB 33	458	735			SEC29-T06S-R27E
AMC 326098	SOB 34	458	736			SEC29-T06S-R27E
AMC 326099	SOB 35	458	737			SEC29-T06S-R27E
AMC 326100	SOB 36	458	738			SEC29-T06S-R27E
AMC 326101	SOB 37	458	739			SEC29-T06S-R27E
AMC 326102	SOB 38	458	740			SEC29-T06S-R27E
AMC 326103	SOB 39	458	741			SEC29-T06S-R27E
AMC 326104	SOB 40	458	742			SEC29-T06S-R27E
AMC 326105	SOB 41	458	743			SEC29-T06S-R27E
AMC 326106	SOB 42	458	744			SEC29-T06S-R27E
AMC 326107	SOB 43	458	745			SEC29-T06S-R27E
AMC 326108	SOB 44	458	746			SEC29-T06S-R27E
AMC 326109	SOB 45	458	747			SEC29-T06S-R27E
AMC 326110	SOB 46	458	748			SEC29-T06S-R27E
AMC 326111	SOB 47	458	749			SEC21-T06S-R27E
AMC 326112	SOB 48	458	750			SEC21-T06S-R27E
AMC 326113	SOB 49	458	751			SEC21-T06S-R27E
AMC 326114	SOB 50	458	752			SEC21-T06S-R27E
AMC 326115	SOB 51	458	753			SEC28-T06S-R27E
AMC 326116	SOB 52	458	754			SEC28-T06S-R27E
AMC 326117	SOB 53	458	755			SEC28-T06S-R27E
AMC 326118	SOB 54	458	756			SEC28-T06S-R27E
AMC 326119	SOB 55	458	757			SEC28-T06S-R27E
AMC 326120	SOB 56	458	758			SEC28-T06S-R27E
AMC 326121	SOB 57	458	759			SEC28-T06S-R27E
AMC 326122	SOB 58	458	760			SEC28-T06S-R27E
AMC 326123	SOB 59	458	761			SEC28-T06S-R27E
AMC 326124	SOB 60	458	762			SEC28-T06S-R27E
AMC 326125	SOB 61	458	763			SEC28-T06S-R27E
AMC 326126	SOB 62	458	764			SEC28-T06S-R27E
AMC 326127	SOB 63	458	765			SEC28-T06S-R27E
AMC 326128	SOB 64	458	766			SEC28-T06S-R27E
AMC 326129	SOB 65	458	767			SEC28-T06S-R27E
AMC 326130	SOB 66	458	768			SEC28-T06S-R27E

Date: 6/1/2017

RECEIVED  
BLM AZ STATE OFFICE  
JUL 12 2017  
PHOENIX, ARIZ

## Exhibit A

County: Graham

State: AZ

BLM Serial #	Claim Name	Original Recording		Amended Recording		Location
		Recording #	Page #	Recording #	Page #	
AMC 326131	SOB 67	458	769			SEC28-T06S-R27E
AMC 326132	SOB 68	458	770			SEC28-T06S-R27E
AMC 326133	SOB 69	458	771			SEC28-T06S-R27E
AMC 326134	SOB 70	458	772			SEC28-T06S-R27E
AMC 326135	SOB 71	458	773			SEC28-T06S-R27E
AMC 326136	SOB 72	458	774			SEC28-T06S-R27E
AMC 326137	SOB 73	458	775			SEC28-T06S-R27E
AMC 326138	SOB 74	458	776			SEC28-T06S-R27E
AMC 326139	SOB 75	458	777			SEC28-T06S-R27E
AMC 326140	SOB 76	458	778			SEC28-T06S-R27E
AMC 326141	SOB 77	458	779			SEC21-T06S-R27E
AMC 326142	SOB 78	458	780			SEC21-T06S-R27E
AMC 326143	SOB 79	458	781			SEC28-T06S-R27E
AMC 326144	SOB 80	458	782			SEC28-T06S-R27E
AMC 326145	SOB 81	458	783			SEC28-T06S-R27E
AMC 326146	SOB 82	458	784			SEC28-T06S-R27E
AMC 326147	SOB 83	458	785			SEC28-T06S-R27E
AMC 326148	SOB 84	458	786			SEC28-T06S-R27E
AMC 326149	SOB 85	458	787			SEC28-T06S-R27E
AMC 326150	SOB 86	458	788			SEC28-T06S-R27E
AMC 326151	SOB 87	458	789			SEC28-T06S-R27E
AMC 326152	SOB 88	458	790			SEC28-T06S-R27E
AMC 326153	SOB 89	458	791			SEC28-T06S-R27E
AMC 326154	SOB 90	458	792			SEC28-T06S-R27E
AMC 326155	SOB 91	458	793			SEC28-T06S-R27E
AMC 326156	SOB 92	458	794			SEC28-T06S-R27E
AMC 326157	SOB 93	458	795			SEC28-T06S-R27E
AMC 326158	SOB 94	458	796			SEC28-T06S-R27E
AMC 326159	SOB 95	458	797			SEC28-T06S-R27E
AMC 326160	SOB 96	458	798			SEC28-T06S-R27E
AMC 326161	SOB 97	458	799			SEC28-T06S-R27E
AMC 326162	SOB 98	458	800			SEC28-T06S-R27E
AMC 326163	SOB 99	458	801			SEC28-T06S-R27E
AMC 326164	SOB 100	458	802			SEC28-T06S-R27E
AMC 326165	SOB 101	458	803			SEC28-T06S-R27E
AMC 326166	SOB 102	458	804			SEC28-T06S-R27E
AMC 326167	SOB 103	458	805			SEC28-T06S-R27E
AMC 326168	SOB 104	458	806			SEC28-T06S-R27E

Date: 6/1/2017

RECEIVED  
BLM AZ STATE OFFICE  
JUN 12 10 10 AM '17  
Page 21

## Exhibit A

County: Graham

State: AZ

<u>BLM Serial #</u>	<u>Claim Name</u>	<u>Original Recording</u>		<u>Amended Recording</u>		<u>Location</u>
		<u>Recording #</u>	<u>Page #</u>	<u>Recording #</u>	<u>Page #</u>	
AMC 326169	SOB 105	458	807			SEC28-T06S-R27E
AMC 326170	SOB 106	458	808			SEC28-T06S-R27E
AMC 326171	SOB 107	458	809			SEC28-T06S-R27E
AMC 326172	SOB 108	458	810			SEC28-T06S-R27E
AMC 326173	SOB 109	458	811			SEC28-T06S-R27E
AMC 326174	SOB 110	458	812			SEC28-T06S-R27E
AMC 326175	SOB 111	458	813			SEC33-T06S-R27E
AMC 326176	SOB 112	458	814			SEC33-T06S-R27E
AMC 326177	SOB 113	458	815			SEC33-T06S-R27E
AMC 326178	SOB 114	458	816			SEC33-T06S-R27E
AMC 326179	SOB 115	458	817			SEC28-T06S-R27E
AMC 326180	SOB 116	458	818			SEC28-T06S-R27E
AMC 326181	SOB 117	458	819			SEC28-T06S-R27E
AMC 326182	SOB 118	458	820			SEC28-T06S-R27E
AMC 326183	SOB 119	458	821			SEC28-T06S-R27E
AMC 326184	SOB 120	458	822			SEC28-T06S-R27E
AMC 326185	SOB 121	458	823			SEC28-T06S-R27E
AMC 326186	SOB 122	458	824			SEC28-T06S-R27E
AMC 326187	SOB 123	458	825			SEC28-T06S-R27E
AMC 326188	SOB 124	458	826			SEC28-T06S-R27E
AMC 326189	SOB 125	458	827			SEC28-T06S-R27E
AMC 326190	SOB 126	458	828			SEC28-T06S-R27E
AMC 326191	SOB 127	458	829			SEC28-T06S-R27E
AMC 326192	SOB 128	458	830			SEC28-T06S-R27E
AMC 326193	SOB 129	458	831			SEC28-T06S-R27E
AMC 326194	SOB 130	458	832			SEC28-T06S-R27E
AMC 326195	SOB 131	458	833			SEC28-T06S-R27E
AMC 326196	SOB 132	458	834			SEC28-T06S-R27E
AMC 326197	SOB 133	458	835			SEC28-T06S-R27E
AMC 326198	SOB 134	458	836			SEC28-T06S-R27E
AMC 326199	SOB 135	458	837			SEC28-T06S-R27E
AMC 326200	SOB 136	458	838			SEC28-T06S-R27E
AMC 326201	SOB 137	458	839			SEC28-T06S-R27E
AMC 326202	SOB 138	458	840			SEC28-T06S-R27E
AMC 326203	SOB 139	458	841			SEC28-T06S-R27E
AMC 326204	SOB 140	458	842			SEC28-T06S-R27E
AMC 326205	SOB 141	458	843			SEC28-T06S-R27E
AMC 326206	SOB 142	458	844			SEC28-T06S-R27E

Date: 6/1/2017

RECEIVED  
BLMAZ STATE OFFICE  
PHOENIX, ARIZ  
JUL 12 2017

## Exhibit A

County: Graham

State: AZ

BLM Serial #	Claim Name	Original Recording		Amended Recording		Location
		Recording #	Page #	Recording #	Page #	
AMC 326207	SOB 143	458	845			SEC28-T06S-R27E
AMC 326208	SOB 144	458	846			SEC28-T06S-R27E
AMC 326209	SOB 145	458	847			SEC28-T06S-R27E
AMC 326210	SOB 146	458	848			SEC33-T06S-R27E
AMC 326211	SOB 147	458	849			SEC33-T06S-R27E
AMC 326212	SOB 148	458	850			SEC33-T06S-R27E
AMC 326213	SOB 149	458	851			SEC33-T06S-R27E
AMC 326214	SOB 150	458	852			SEC33-T06S-R27E
AMC 326215	SOB 151	458	853			SEC33-T06S-R27E
AMC 326216	SOB 152	458	854			SEC28-T06S-R27E
AMC 326217	SOB 153	458	855			SEC28-T06S-R27E
AMC 326218	SOB 154	458	856			SEC28-T06S-R27E
AMC 326219	SOB 155	458	857			SEC28-T06S-R27E
AMC 326220	SOB 156	458	858			SEC28-T06S-R27E
AMC 326221	SOB 157	458	859			SEC28-T06S-R27E
AMC 326222	SOB 158	458	860			SEC28-T06S-R27E
AMC 326223	SOB 159	458	861			SEC28-T06S-R27E
AMC 326224	SOB 160	458	862			SEC28-T06S-R27E
AMC 326225	SOB 161	458	863			SEC28-T06S-R27E
AMC 326226	SOB 162	458	864			SEC28-T06S-R27E
AMC 326227	SOB 163	458	865			SEC28-T06S-R27E
AMC 326228	SOB 164	458	866			SEC28-T06S-R27E
AMC 326229	SOB 165	458	867			SEC28-T06S-R27E
AMC 326230	SOB 166	458	868			SEC28-T06S-R27E
AMC 326231	SOB 167	458	869			SEC28-T06S-R27E
AMC 326232	SOB 168	458	870			SEC28-T06S-R27E
AMC 326233	SOB 169	458	871			SEC28-T06S-R27E
AMC 326234	SOB 170	458	872			SEC28-T06S-R27E
AMC 326235	SOB 171	458	873			SEC28-T06S-R27E
AMC 326236	SOB 172	458	874			SEC28-T06S-R27E
AMC 326237	SOB 173	458	875			SEC28-T06S-R27E
AMC 326238	SOB 174	458	876			SEC28-T06S-R27E
AMC 326239	SOB 175	458	877			SEC28-T06S-R27E
AMC 326240	SOB 176	458	878			SEC28-T06S-R27E
AMC 326241	SOB 177	458	879			SEC28-T06S-R27E
AMC 326242	SOB 178	458	880			SEC28-T06S-R27E
AMC 326243	SOB 179	458	881			SEC28-T06S-R27E
AMC 326244	SOB 180	458	882			SEC33-T06S-R27E

Date: 6/1/2017

RECEIVED  
BLM AZ STATE OFFICE  
JUL 12 2 10 PM '17  
PHOENIX, ARIZ

## Exhibit A

County: Graham

State: AZ

<u>BLM Serial #</u>	<u>Claim Name</u>	<u>Original Recording</u>		<u>Amended Recording</u>		<u>Location</u>
		<u>Recording #</u>	<u>Page #</u>	<u>Recording #</u>	<u>Page #</u>	
AMC 326245	SOB 181	458	883			SEC33-T06S-R27E
AMC 326246	SOB 182	458	884			SEC33-T06S-R27E
AMC 326247	SOB 183	458	885			SEC33-T06S-R27E
AMC 326248	SOB 184	458	886			SEC33-T06S-R27E
AMC 326249	SOB 185	458	887			SEC33-T06S-R27E
AMC 326250	SOB 186	458	888			SEC33-T06S-R27E
AMC 326251	SOB 187	458	889			SEC33-T06S-R27E
AMC 326252	SOB 188	458	890			SEC27-T06S-R27E
AMC 326253	SOB 189	458	891			SEC27-T06S-R27E
AMC 326254	SOB 190	458	892			SEC27-T06S-R27E
AMC 326255	SOB 191	458	893			SEC27-T06S-R27E
AMC 326256	SOB 192	458	894			SEC27-T06S-R27E
AMC 326257	SOB 193	458	895			SEC27-T06S-R27E
AMC 326258	SOB 194	458	896			SEC27-T06S-R27E
AMC 326259	SOB 195	458	897			SEC27-T06S-R27E
AMC 326260	SOB 196	458	898			SEC27-T06S-R27E
AMC 326261	SOB 197	458	899			SEC27-T06S-R27E
AMC 326262	SOB 198	458	900			SEC27-T06S-R27E
AMC 326263	SOB 199	458	901			SEC27-T06S-R27E
AMC 326264	SOB 200	458	902			SEC27-T06S-R27E
AMC 326265	SOB 201	458	903			SEC27-T06S-R27E
AMC 326266	SOB 202	458	904			SEC27-T06S-R27E
AMC 326267	SOB 203	458	905			SEC27-T06S-R27E
AMC 326268	SOB 204	458	906			SEC27-T06S-R27E
AMC 326269	SOB 205	458	907			SEC27-T06S-R27E
AMC 326270	SOB 206	458	908			SEC27-T06S-R27E
AMC 326271	SOB 207	458	909			SEC27-T06S-R27E
AMC 326272	SOB 208	458	910			SEC27-T06S-R27E
AMC 326273	SOB 209	458	911			SEC27-T06S-R27E
AMC 326274	SOB 210	458	912			SEC27-T06S-R27E
AMC 326275	SOB 211	458	913			SEC27-T06S-R27E
AMC 326276	SOB 212	458	914			SEC27-T06S-R27E
AMC 326277	SOB 213	458	915			SEC34-T06S-R27E
AMC 326278	SOB 214	458	916			SEC34-T06S-R27E
AMC 326279	SOB 215	458	917			SEC26-T06S-R27E
AMC 326280	SOB 216	458	918			SEC26-T06S-R27E
AMC 326281	SOB 217	458	919			SEC26-T06S-R27E
AMC 326282	SOB 218	458	920			SEC26-T06S-R27E

Date: 6/1/2017

RECEIVED  
BLM AZ STATE OFFICE  
JUL 12 10 17 AM '17  
PHOENIX, AZ

## Exhibit A

County: Graham

State: AZ

BLM Serial #	Claim Name	Original Recording		Amended Recording		Location
		Recording #	Page #	Recording #	Page #	
AMC 326843	M19	463	593			SEC14-T06S-R27E
AMC 326844	M20	463	595			SEC14-T06S-R27E
AMC 326845	M21	463	597			SEC14-T06S-R27E
AMC 326846	M22	463	599			SEC14-T06S-R27E
AMC 326847	M23	463	601			SEC14-T06S-R27E
AMC 326848	M24	463	603			SEC14-T06S-R27E
AMC 326849	M25	463	605			SEC14-T06S-R27E
AMC 326850	M26	463	607			SEC14-T06S-R27E
AMC 326851	M27	463	609			SEC14-T06S-R27E
AMC 326852	M28	463	611			SEC14-T06S-R27E
AMC 326853	M29	463	613			SEC14-T06S-R27E
AMC 326854	M30	463	615			SEC14-T06S-R27E
AMC 326855	M31	463	617			SEC14-T06S-R27E
AMC 326856	M55	463	629			SEC14-T06S-R27E
AMC 326857	M32	463	619			SEC14-T06S-R27E
AMC 326858	M33	463	621			SEC14-T06S-R27E
AMC 326859	M34	463	623			SEC14-T06S-R27E
AMC 326860	M35	463	625			SEC14-T06S-R27E
AMC 326861	M36	463	627			SEC14-T06S-R27E
AMC 326862	M57	463	631			SEC14-T06S-R27E
AMC 326863	M59	463	633			SEC14-T06S-R27E
AMC 326864	M61	463	635			SEC14-T06S-R27E
AMC 326865	M63	463	637			SEC14-T06S-R27E
AMC 326866	M65	463	639			SEC14-T06S-R27E
AMC 326867	M67	463	641			SEC14-T06S-R27E
AMC 326868	M69	463	643			SEC14-T06S-R27E
AMC 326869	M71	463	645			SEC14-T06S-R27E
AMC 326870	M145	463	647			SEC22-T06S-R27E
AMC 326871	M146	463	649			SEC22-T06S-R27E
AMC 326872	M147	463	651			SEC22-T06S-R27E
AMC 326873	M148	463	653			SEC22-T06S-R27E
AMC 326874	M149	463	655			SEC22-T06S-R27E
AMC 326875	M150	463	657			SEC22-T06S-R27E
AMC 326876	M151	463	659			SEC22-T06S-R27E
AMC 326877	M152	463	661			SEC22-T06S-R27E
AMC 326878	M153	463	663			SEC22-T06S-R27E
AMC 326879	M154	463	665			SEC22-T06S-R27E
AMC 326880	M155	463	667			SEC22-T06S-R27E

Date: 6/1/2017

RECEIVED  
BLM AZ STATE OFFICE  
JUL 12 2017 10:09 AM  
PHOENIX, ARIZONA

## Exhibit A

County: Graham

State: AZ

BLM Serial #	Claim Name	Original Recording		Amended Recording		Location
		Recording #	Page #	Recording #	Page #	
AMC 326881	M156	463	669			SEC22-T06S-R27E
AMC 326882	M157	463	671			SEC22-T06S-R27E
AMC 326883	M158	463	673			SEC22-T06S-R27E
AMC 326884	M159	463	675			SEC22-T06S-R27E
AMC 326885	M160	463	677			SEC22-T06S-R27E
AMC 326886	M161	463	679			SEC22-T06S-R27E
AMC 326887	M162	463	681			SEC22-T06S-R27E
AMC 326888	M163	463	683			SEC23-T06S-R27E
AMC 326889	M164	463	685			SEC23-T06S-R27E
AMC 326890	M165	463	687			SEC23-T06S-R27E
AMC 326891	M166	463	689			SEC23-T06S-R27E
AMC 326892	M167	463	691			SEC23-T06S-R27E
AMC 326893	M168	463	693			SEC23-T06S-R27E
AMC 326894	M169	463	695			SEC23-T06S-R27E
AMC 326895	M170	463	697			SEC23-T06S-R27E
AMC 326896	M171	463	699			SEC23-T06S-R27E
AMC 326897	M172	463	701			SEC23-T06S-R27E
AMC 326898	M173	463	703			SEC23-T06S-R27E
AMC 326899	M174	463	705			SEC23-T06S-R27E
AMC 326900	M175	463	707			SEC23-T06S-R27E
AMC 326901	M176	463	709			SEC23-T06S-R27E
AMC 326902	M177	463	711			SEC23-T06S-R27E
AMC 326903	M178	463	713			SEC23-T06S-R27E
AMC 326904	M188	463	715			SEC22-T06S-R27E
AMC 326905	M189	463	717			SEC22-T06S-R27E
AMC 326906	M190	463	719			SEC22-T06S-R27E
AMC 326907	M191	463	721			SEC22-T06S-R27E
AMC 326908	M192	463	723			SEC22-T06S-R27E
AMC 326909	M193	463	725			SEC22-T06S-R27E
AMC 326910	M194	463	727			SEC22-T06S-R27E
AMC 326911	M195	463	729			SEC22-T06S-R27E
AMC 326912	M196	463	731			SEC22-T06S-R27E
AMC 326913	M197	463	733			SEC23-T06S-R27E
AMC 326914	M199	463	735			SEC22-T06S-R27E
AMC 326915	M200	463	737			SEC22-T06S-R27E
AMC 326916	M201	463	739			SEC22-T06S-R27E
AMC 326917	M202	463	741			SEC22-T06S-R27E
AMC 326918	M203	463	743			SEC22-T06S-R27E

Date: 6/1/2017

RECEIVED  
BLM AZ STATE OFF  
JUL 12 2017

## Exhibit A

County: Graham

State: AZ

BLM Serial #	Claim Name	Original Recording		Amended Recording		Location
		Recording #	Page #	Recording #	Page #	
AMC 326919	M204	463	745			SEC22-T06S-R27E
AMC 326920	M205	463	747			SEC22-T06S-R27E
AMC 326921	M206	463	749			SEC22-T06S-R27E
AMC 329068	MG 5	471	483			SEC20-T05S-R26E
AMC 329077	MG 24	471	501			SEC20-T05S-R26E
AMC 329078	MG 25	471	503			SEC20-T05S-R26E
AMC 329087	MG 83	471	521			SEC19-T05S-R26E
AMC 329088	MG 84	471	523			SEC19-T05S-R26E
AMC 329089	MG 131	471	525			SEC19-T05S-R26E
AMC 329090	MG 133	471	527			SEC19-T05S-R26E
AMC 329091	MG 135	471	529			SEC19-T05S-R26E
AMC 329092	MG 137	471	531			SEC19-T05S-R26E
AMC 329093	MG 139	471	533			SEC19-T05S-R26E
AMC 329113	Joy 179	471	573			SEC10-T06S-R26E
AMC 329115	Joy 181	471	577			SEC10-T06S-R26E
AMC 329123	Joy 189	471	593			SEC10-T06S-R26E
AMC 329124	Joy 190	471	595			SEC11-T06S-R26E
AMC 329125	Joy 191	471	597			SEC11-T06S-R26E
AMC 329126	Joy 192	471	599			SEC11-T06S-R26E
AMC 329127	Joy 193	471	601			SEC11-T06S-R26E
AMC 329128	Joy 194	471	603			SEC11-T06S-R26E
AMC 329129	Joy 195	471	605			SEC11-T06S-R26E
AMC 329130	Joy 196	471	607			SEC11-T06S-R26E
AMC 329144	Joy 210A	471	635	481	919	SEC02-T06S-R26E
AMC 329145	Joy 212A	471	637	481	923	SEC02-T06S-R26E
AMC 330969	Joy 214	478	215			SEC02-T06S-R26E
AMC 330971	Joy 216	478	219			SEC02-T06S-R26E
AMC 330973	Joy 218	478	223			SEC02-T06S-R26E
AMC 331745	Joy 303	483	801			SEC14-T06S-R26E
AMC 331747	Joy 305	483	805			SEC14-T06S-R26E
AMC 331749	Joy 307	483	809			SEC14-T06S-R26E
AMC 331751	Joy 309	483	813			SEC14-T06S-R26E
AMC 331752	Joy 310	483	815			SEC14-T06S-R26E
AMC 331753	Joy 312	483	817			SEC14-T06S-R26E
AMC 333390	M207	488	141			SEC21-T06S-R27E
AMC 333391	M208	488	143			SEC21-T06S-R27E
AMC 333392	M209	488	145			SEC21-T06S-R27E
AMC 333393	M210	488	147			SEC21-T06S-R27E

Date: 6/1/2017

RECEIVED  
BLM AZ STATE OFFICE  
2017 JUL 12 A 10  
PHOENIX, ARIZ



## Exhibit A

County: Graham

State: AZ

BLM Serial #	Claim Name	Original Recording		Amended Recording		Location
		Recording #	Page #	Recording #	Page #	
AMC 333394	M211	488	149			SEC21-T06S-R27E
AMC 333395	M212	488	151			SEC21-T06S-R27E
AMC 333396	M213	488	153			SEC21-T06S-R27E
AMC 333397	M214	488	155			SEC21-T06S-R27E
AMC 333398	M215	488	157			SEC21-T06S-R27E
AMC 333399	M216	488	159			SEC21-T06S-R27E
AMC 333400	M217	488	161			SEC21-T06S-R27E
AMC 333401	M218	488	163			SEC21-T06S-R27E
AMC 333402	M219	488	165			SEC21-T06S-R27E
AMC 333403	M220	488	167			SEC21-T06S-R27E
AMC 333404	M221	488	169			SEC21-T06S-R27E
AMC 333405	M222	488	171			SEC21-T06S-R27E
AMC 333406	M223	488	173			SEC21-T06S-R27E
AMC 333407	M224	488	175			SEC21-T06S-R27E
AMC 333408	M225	488	177			SEC21-T06S-R27E
AMC 333409	M226	488	179			SEC21-T06S-R27E
AMC 333410	M227	488	181			SEC21-T06S-R27E
AMC 333411	M228	488	183			SEC21-T06S-R27E
AMC 333412	M229	488	185			SEC21-T06S-R27E
AMC 333413	M230	488	187			SEC21-T06S-R27E
AMC 333414	M231	488	189			SEC21-T06S-R27E
AMC 333415	M232	488	191			SEC21-T06S-R27E
AMC 333416	M233	488	193			SEC21-T06S-R27E
AMC 333417	M234	488	195			SEC21-T06S-R27E
AMC 333418	M235	488	197			SEC21-T06S-R27E
AMC 333419	M236	488	199			SEC16-T06S-R27E
AMC 333420	M237	488	201			SEC16-T06S-R27E
AMC 333421	M238	488	203			SEC16-T06S-R27E
AMC 334772	CHE 1	492	843			SEC23-T05S-R25E
AMC 334773	CHE 2	492	845			SEC23-T05S-R25E
AMC 334774	CHE 3	492	847			SEC23-T05S-R25E
AMC 334775	CHE 4	492	849			SEC23-T05S-R25E
AMC 334776	CHE 5	492	851			SEC23-T05S-R25E
AMC 334777	CHE 6	492	853			SEC23-T05S-R25E
AMC 334778	CHE 7	492	855			SEC23-T05S-R25E
AMC 334779	CHE 8	492	857			SEC23-T05S-R25E
AMC 334780	CHE 9	492	859			SEC23-T05S-R25E
AMC 334781	CHE 10	492	861			SEC23-T05S-R25E

Date: 6/1/2017

RECEIVED  
BLM AZ STATE OFF  
JUL 12 2017  
MIX AREA

## Exhibit A

County: Graham

State: AZ

<u>BLM Serial #</u>	<u>Claim Name</u>	<u>Original Recording</u>		<u>Amended Recording</u>		<u>Location</u>
		<u>Recording #</u>	<u>Page #</u>	<u>Recording #</u>	<u>Page #</u>	
AMC 334782	CHE 11	492	863			SEC26-T05S-R25E
AMC 334783	CHE 12	492	865			SEC26-T05S-R25E
AMC 334784	CHE 13	492	867			SEC26-T05S-R25E
AMC 334785	CHE 14	492	869			SEC26-T05S-R25E
AMC 334786	CHE 15	492	871			SEC26-T05S-R25E
AMC 334787	CHE 16	492	873			SEC26-T05S-R25E
AMC 334788	CHE 17	492	875			SEC26-T05S-R25E
AMC 334789	CHE 18	492	877			SEC26-T05S-R25E
AMC 334790	CHE 19	492	879			SEC26-T05S-R25E
AMC 334791	CHE 20	492	881			SEC26-T05S-R25E
AMC 334792	CHE 21	492	883			SEC26-T05S-R25E
AMC 334793	CHE 22	492	885			SEC26-T05S-R25E
AMC 334794	CHE 23	492	887			SEC26-T05S-R25E
AMC 334795	CHE 24	492	889			SEC26-T05S-R25E
AMC 334796	CHE 25	492	891			SEC26-T05S-R25E
AMC 334797	CHE 26	492	893			SEC26-T05S-R25E
AMC 334798	CHE 27	492	895			SEC26-T05S-R25E
AMC 334799	CHE 28	492	897			SEC26-T05S-R25E
AMC 334800	CHE 29	492	899			SEC23-T05S-R25E
AMC 334801	CHE 30	492	901			SEC23-T05S-R25E
AMC 334802	CHE 31	492	903			SEC23-T05S-R25E
AMC 334803	CHE 32	492	905			SEC23-T05S-R25E
AMC 334804	CHE 33	492	907			SEC23-T05S-R25E
AMC 334805	CHE 34	492	909			SEC23-T05S-R25E
AMC 334806	CHE 35	492	911			SEC23-T05S-R25E
AMC 334807	CHE 36	492	913			SEC23-T05S-R25E
AMC 334808	CHE 37	492	915			SEC23-T05S-R25E
AMC 334809	CHE 38	492	917			SEC23-T05S-R25E
AMC 334810	CHE 39	492	919			SEC26-T05S-R25E
AMC 334811	CHE 40	492	921			SEC26-T05S-R25E
AMC 334812	CHE 41	492	923			SEC26-T05S-R25E
AMC 334813	CHE 42	492	925			SEC26-T05S-R25E
AMC 334814	CHE 43	492	927			SEC26-T05S-R25E
AMC 334815	CHE 44	492	929			SEC26-T05S-R25E
AMC 334816	CHE 45	492	931			SEC26-T05S-R25E
AMC 334817	CHE 46	492	933			SEC26-T05S-R25E
AMC 334818	CHE 47	492	935			SEC26-T05S-R25E
AMC 334819	CHE 48	492	937			SEC26-T05S-R25E

Date: 6/1/2017

RECEIVED  
BMAZ STATE OFFICE  
JUL 12 10:41  
PHOENIX, ARIZO

## Exhibit A

County: Graham

State: AZ

BLM Serial #	Claim Name	Original Recording		Amended Recording		Location
		Recording #	Page #	Recording #	Page #	
AMC 334820	CHE 49	492	939			SEC26-T05S-R25E
AMC 334821	CHE 50	492	941			SEC26-T05S-R25E
AMC 334822	CHE 51	492	943			SEC26-T05S-R25E
AMC 334823	CHE 52	492	945			SEC26-T05S-R25E
AMC 334824	CHE 53	492	947			SEC26-T05S-R25E
AMC 334825	CHE 54	492	949			SEC26-T05S-R25E
AMC 334826	CHE 55	492	951			SEC26-T05S-R25E
AMC 334827	CHE 56	492	953			SEC26-T05S-R25E
AMC 340515	BH 21	510	117			SEC24-T05S-R26E
AMC 340539	Cliff 1R	510	1			SEC22-T05S-R26E
AMC 340540	Cliff 2R	510	3			SEC22-T05S-R26E
AMC 340541	Cliff 3R	510	5			SEC22-T05S-R26E
AMC 340542	Cliff 4R	510	7			SEC22-T05S-R26E
AMC 340543	Cliff 6R	510	9			SEC22-T05S-R26E
AMC 340544	Cliff 8R	510	11			SEC22-T05S-R26E
AMC 340545	Cliff 23R	510	13			SEC26-T05S-R26E
AMC 340546	Cliff 24R	510	15			SEC26-T05S-R26E
AMC 340547	Cliff 25R	510	17			SEC23-T05S-R26E
AMC 340548	Cliff 26R	510	19			SEC23-T05S-R26E
AMC 340549	Cliff 27R	510	21			SEC23-T05S-R26E
AMC 340550	Cliff 28R	510	23			SEC23-T05S-R26E
AMC 340551	Cliff 29R	510	25			SEC23-T05S-R26E
AMC 340552	Cliff 30R	510	27			SEC23-T05S-R26E
AMC 340553	Cliff 31R	510	29			SEC23-T05S-R26E
AMC 340554	Cliff 32R	510	31			SEC23-T05S-R26E
AMC 340558	Cliff 41R Amended	510	39	532	479	SEC23-T05S-R26E
AMC 340559	Cliff 42R Amended	510	41	532	751	SEC23-T05S-R26E
AMC 340560	Cliff 43R Amended	510	43	532	753	SEC23-T05S-R26E
AMC 340561	Cliff 44R Amended	510	45	532	755	SEC23-T05S-R26E
AMC 340562	Cliff 45	510	47			SEC23-T05S-R26E
AMC 340563	Cliff 46	510	49			SEC23-T05S-R26E
AMC 340564	Cliff 59	510	51			SEC23-T05S-R26E
AMC 340565	Cliff 60	510	53			SEC23-T05S-R26E
AMC 340566	Cliff 61	510	55			SEC23-T05S-R26E
AMC 340567	Cliff 62	510	57			SEC23-T05S-R26E
AMC 340568	Cliff 63	510	59			SEC23-T05S-R26E
AMC 340569	Cliff 64	510	61			SEC14-T05S-R26E
AMC 340570	Cliff 65	510	63			SEC14-T05S-R26E

Date: 6/1/2017

RECEIVED  
BLM AZ STATE OFFICE  
2017 JUL 12 A 10:11  
PHOENIX, ARIZO

## Exhibit A

County: Graham

State: AZ

BLM Serial #	Claim Name	Original Recording		Amended Recording		Location
		Recording #	Page #	Recording #	Page #	
AMC 340956	SG 1	513	27			SEC20-T06S-R27E
AMC 340957	SG 2	513	29			SEC28-T06S-R27E
AMC 340958	SG 3	513	31			SEC29-T06S-R27E
AMC 340959	SG 4	513	33			SEC29-T06S-R27E
AMC 340960	SG 5	513	35			SEC29-T06S-R27E
AMC 340961	SG 6	513	37			SEC33-T06S-R27E
AMC 340962	SG 7	513	39			SEC33-T06S-R27E
AMC 340963	SG 8	513	41			SEC33-T06S-R27E
AMC 340964	SG 9	513	43			SEC04-T07S-R27E
AMC 340965	SG 10	513	45			SEC04-T07S-R27E
AMC 340966	SG 11	513	47			SEC04-T07S-R27E
AMC 340967	SG 12 Amended	513	49	525	947	SEC04-T07S-R27E
AMC 340968	SG 13	513	51			SEC04-T07S-R27E
AMC 340969	SG 14	513	53			SEC04-T07S-R27E
AMC 340970	SG 15	513	55			SEC33-T06S-R27E
AMC 340971	SG 16	513	57			SEC33-T06S-R27E
AMC 340972	SG 17	513	59			SEC33-T06S-R27E
AMC 340973	SG 18	513	61			SEC33-T06S-R27E
AMC 340974	SG 19	513	63			SEC33-T06S-R27E
AMC 340975	SG 20	513	65			SEC33-T06S-R27E
AMC 340976	SG 21	513	67			SEC34-T06S-R27E
AMC 340977	SG 22	513	69			SEC34-T06S-R27E
AMC 340978	SG 23	513	71			SEC27-T06S-R27E
AMC 340979	SG 24	513	73			SEC34-T06S-R27E
AMC 340980	SG 25	513	75			SEC34-T06S-R27E
AMC 340981	SG 26	513	77			SEC27-T06S-R27E
AMC 340982	SG 27	513	79			SEC27-T06S-R27E
AMC 340983	SG 28	513	81			SEC26-T06S-R27E
AMC 340984	SG 29	513	83			SEC27-T06S-R27E
AMC 340985	SG 30	513	85			SEC27-T06S-R27E
AMC 340986	SG 31	513	87			SEC26-T06S-R27E
AMC 340987	SG 32	513	89			SEC27-T06S-R27E
AMC 340988	SG 33	513	91			SEC27-T06S-R27E
AMC 340989	SG 34	513	93			SEC23-T06S-R27E
AMC 340990	SG 35	513	95			SEC23-T06S-R27E
AMC 340991	SG 36	513	97			SEC23-T06S-R27E
AMC 340992	SG 37	513	99			SEC23-T06S-R27E
AMC 340993	SG 38	513	101			SEC28-T06S-R27E

Date: 6/1/2017

RECEIVED  
BLM AZ STATE OFFICE  
2017 JUL 12 A 10:16  
PHOENIX, ARIZONA

## Exhibit A

County: Graham

State: AZ

BLM Serial #	Claim Name	Original Recording		Amended Recording		Location
		Recording #	Page #	Recording #	Page #	
AMC 340994	SG 39	513	103			SEC24-T06S-R27E
AMC 340995	SG 40	513	105			SEC25-T06S-R27E
AMC 340996	SG 41	513	107			SEC27-T06S-R27E
AMC 340997	SG 42	513	109			SEC28-T06S-R27E
AMC 340998	SG 43	513	111			SEC28-T06S-R27E
AMC 340999	SG 44	513	113			SEC23-T06S-R27E
AMC 341000	SG 45	513	115			SEC23-T06S-R27E
AMC 341001	SG 46	513	117			SEC25-T06S-R27E
AMC 341002	SZ 1	513	119			SEC29-T06S-R27E
AMC 341003	SZ 2	513	121			SEC29-T06S-R27E
AMC 341004	SZ 3	513	123			SEC29-T06S-R27E
AMC 341005	SZ 4	513	125			SEC29-T06S-R27E
AMC 341006	SZ 5	513	127			SEC29-T06S-R27E
AMC 341007	SZ 6	513	129			SEC29-T06S-R27E
AMC 341008	SZ 7	513	131			SEC29-T06S-R27E
AMC 341009	SZ 8	513	133			SEC29-T06S-R27E
AMC 341010	SZ 9	513	135			SEC29-T06S-R27E
AMC 341011	SZ 10	513	137			SEC29-T06S-R27E
AMC 341012	SZ 11	513	139			SEC29-T06S-R27E
AMC 341013	SZ 12	513	141			SEC29-T06S-R27E
AMC 341014	SZ 13	513	143			SEC29-T06S-R27E
AMC 341015	SZ 14	513	145			SEC20-T06S-R27E
AMC 341016	SZ 15	513	147			SEC20-T06S-R27E
AMC 341017	SZ 16	513	149			SEC20-T06S-R27E
AMC 341018	SZ 17	513	151			SEC20-T06S-R27E
AMC 341019	SZ 18	513	153			SEC20-T06S-R27E
AMC 341020	SZ 19	513	155			SEC20-T06S-R27E
AMC 341021	SZ 20	513	157			SEC20-T06S-R27E
AMC 341022	SZ 21	513	159			SEC20-T06S-R27E
AMC 341023	SZ 22	513	161			SEC20-T06S-R27E
AMC 341024	SZ 23	513	163			SEC20-T06S-R27E
AMC 341025	SZ 24	513	165			SEC20-T06S-R27E
AMC 341026	SZ 25	513	167			SEC20-T06S-R27E
AMC 341652	BH 4B	514	787			SEC26-T05S-R26E
AMC 341653	BH 6B	514	789			SEC26-T05S-R26E
AMC 341654	BH 8B	514	791			SEC26-T05S-R26E
AMC 341655	BH 10B	514	793			SEC25-T05S-R26E
AMC 341656	BH 12B	514	795			SEC25-T05S-R26E

Date: 6/1/2017

RECEIVED  
BLM AZ STATE OFFICE

## Exhibit A

County: Graham

State: AZ

BLM Serial #	Claim Name	Original Recording		Amended Recording		Location
		Recording #	Page #	Recording #	Page #	
AMC 341657	BH 14B	514	797			SEC25-T05S-R26E
AMC 341658	BH 16B	514	799			SEC25-T05S-R26E
AMC 341659	BH 18B	514	801			SEC25-T05S-R26E
AMC 341660	BH 20B	514	803			SEC25-T05S-R26E
AMC 341661	BH 22B	514	805			SEC24-T05S-R26E
AMC 341662	BH 25B	514	807			SEC25-T05S-R26E
AMC 341663	BH 26B	514	809			SEC25-T05S-R26E
AMC 341664	BH 27B	514	811			SEC25-T05S-R26E
AMC 341665	BH 28B	514	813			SEC25-T05S-R26E
AMC 341666	BH 29B	514	815			SEC25-T05S-R26E
AMC 341667	BH 30B	514	817			SEC25-T05S-R26E
AMC 341668	BH 31B	514	819			SEC25-T05S-R26E
AMC 341669	BH 32B	514	821			SEC25-T05S-R26E
AMC 341670	BH 33B	514	823			SEC25-T05S-R26E
AMC 341671	BH 34B	514	825			SEC25-T05S-R26E
AMC 341672	BH 35B	514	827			SEC25-T05S-R26E
AMC 341673	BH 36B	514	829			SEC25-T05S-R26E
AMC 341674	BH 37B	514	831			SEC25-T05S-R26E
AMC 341675	BH 38B	514	833			SEC25-T05S-R26E
AMC 341676	BH 39B	514	835			SEC25-T05S-R26E
AMC 341677	BH 40B	514	837			SEC25-T05S-R26E
AMC 341678	BH 41B	514	839			SEC25-T05S-R26E
AMC 341679	BH 42B	514	841			SEC25-T05S-R26E
AMC 341680	BH 43B	514	843			SEC24-T05S-R26E
AMC 341681	BH 44B	514	845			SEC24-T05S-R26E
AMC 344109	SL 1	519	61			SEC26-T06S-R27E
AMC 344110	SL 2	519	63			SEC26-T06S-R27E
AMC 344111	SL 3	519	65			SEC26-T06S-R27E
AMC 344112	SL 4	519	67			SEC26-T06S-R27E
AMC 344113	SL 5	519	69			SEC26-T06S-R27E
AMC 344114	SL 6	519	71			SEC26-T06S-R27E
AMC 344115	SL 7	519	73			SEC25-T06S-R27E
AMC 344116	SG 47	519	75			SEC26-T06S-R27E
AMC 344117	SG 48	519	77			SEC26-T06S-R27E
AMC 344118	SG 49	519	79			SEC26-T06S-R27E
AMC 344119	SG 50	519	81			SEC23-T06S-R27E
AMC 344120	SG 51	519	83			SEC24-T06S-R27E
AMC 344121	SG 52	519	85			SEC24-T06S-R27E

Date: 6/1/2017

RECEIVED  
BLM AZ STATE OFFICE

## Exhibit A

County: Graham

State: AZ

BLM Serial #	Claim Name	Original Recording		Amended Recording		Location
		Recording #	Page #	Recording #	Page #	
AMC 344122	SG 53		519	419		SEC27-T06S-R27E
AMC 430691	ROCKSTAR 001	2015-1345				SEC01-T06S-R27E
AMC 430692	ROCKSTAR 002	2015-1346				SEC01-T06S-R27E
AMC 430693	ROCKSTAR 003	2015-1347				SEC01-T06S-R27E
AMC 430694	ROCKSTAR 004	2015-1348				SEC01-T06S-R27E
AMC 430695	ROCKSTAR 005	2015-1349				SEC01-T06S-R27E
AMC 430696	ROCKSTAR 006	2015-1350				SEC01-T06S-R27E
AMC 430697	ROCKSTAR 007	2015-1351				SEC01-T06S-R27E
AMC 430698	ROCKSTAR 008	2015-1352				SEC01-T06S-R27E
AMC 430699	ROCKSTAR 009	2015-1353				SEC01-T06S-R27E
AMC 430700	ROCKSTAR 010	2015-1354				SEC01-T06S-R27E
AMC 430701	ROCKSTAR 011	2015-1355				SEC01-T06S-R27E
AMC 430702	ROCKSTAR 012	2015-1356				SEC01-T06S-R27E
AMC 430703	ROCKSTAR 013	2015-1357				SEC01-T06S-R27E
AMC 430704	ROCKSTAR 014	2015-1358				SEC01-T06S-R27E
AMC 430705	ROCKSTAR 015	2015-1359				SEC01-T06S-R27E
AMC 430706	ROCKSTAR 016	2015-1360				SEC01-T06S-R27E
AMC 430707	ROCKSTAR 017	2015-1361				SEC01-T06S-R27E
AMC 430708	ROCKSTAR 018	2015-1362				SEC01-T06S-R27E
AMC 430709	ROCKSTAR 019	2015-1363				SEC01-T06S-R27E
AMC 430710	ROCKSTAR 020	2015-1364				SEC01-T06S-R27E
AMC 430711	ROCKSTAR 021	2015-1365				SEC01-T06S-R27E
AMC 430712	ROCKSTAR 022	2015-1366				SEC01-T06S-R27E
AMC 430713	ROCKSTAR 023	2015-1367				SEC01-T06S-R27E
AMC 430714	ROCKSTAR 024	2015-1368				SEC01-T06S-R27E
AMC 430715	ROCKSTAR 025	2015-1369				SEC01-T06S-R27E
AMC 430716	ROCKSTAR 026	2015-1370				SEC01-T06S-R27E
AMC 430717	ROCKSTAR 027	2015-1371				SEC01-T06S-R27E
AMC 430718	ROCKSTAR 028	2015-1372				SEC01-T06S-R27E
AMC 430719	ROCKSTAR 029	2015-1373				SEC01-T06S-R27E
AMC 430720	ROCKSTAR 030	2015-1374				SEC01-T06S-R27E
AMC 430721	ROCKSTAR 031	2015-1375				SEC01-T06S-R27E
AMC 430722	ROCKSTAR 032	2015-1376				SEC01-T06S-R27E
AMC 430723	ROCKSTAR 033	2015-1377				SEC01-T06S-R27E
AMC 430724	ROCKSTAR 034	2015-1378				SEC01-T06S-R27E
AMC 430725	ROCKSTAR 035	2015-1379				SEC01-T06S-R27E
AMC 430726	ROCKSTAR 036	2015-1380				SEC01-T06S-R27E
AMC 430751	ROCKSTAR 037	2015-1381				SEC02-T06S-R27E

Date: 6/1/2017

RECEIVED  
BLM AZ STATE OFFICE

## Exhibit A

County: Graham

State: AZ

<u>BLM Serial #</u>	<u>Claim Name</u>	<u>Original Recording</u>		<u>Amended Recording</u>		<u>Location</u>
		<u>Recording #</u>	<u>Page #</u>	<u>Recording #</u>	<u>Page #</u>	
AMC 430752	ROCKSTAR 038	2015-1382				SEC02-T06S-R27E
AMC 430753	ROCKSTAR 039	2015-1383				SEC02-T06S-R27E
AMC 430754	ROCKSTAR 040	2015-1384				SEC02-T06S-R27E
AMC 430755	ROCKSTAR 041	2015-1385				SEC02-T06S-R27E
AMC 430756	ROCKSTAR 042	2015-1386				SEC02-T06S-R27E
AMC 430757	ROCKSTAR 043	2015-1387				SEC02-T06S-R27E
AMC 430758	ROCKSTAR 044	2015-1388				SEC02-T06S-R27E
AMC 430759	ROCKSTAR 045	2015-1389				SEC02-T06S-R27E
AMC 430760	ROCKSTAR 046	2015-1390				SEC02-T06S-R27E
AMC 430761	ROCKSTAR 047	2015-1391				SEC02-T06S-R27E
AMC 430762	ROCKSTAR 048	2015-1392				SEC02-T06S-R27E
AMC 430763	ROCKSTAR 049	2015-1393				SEC02-T06S-R27E
AMC 430764	ROCKSTAR 050	2015-1394				SEC02-T06S-R27E
AMC 430765	ROCKSTAR 051	2015-1395				SEC02-T06S-R27E
AMC 430766	ROCKSTAR 052	2015-1396				SEC02-T06S-R27E
AMC 430767	ROCKSTAR 053	2015-1397				SEC02-T06S-R27E
AMC 430768	ROCKSTAR 054	2015-1398				SEC02-T06S-R27E
AMC 430769	ROCKSTAR 055	2015-1399				SEC02-T06S-R27E
AMC 430770	ROCKSTAR 056	2015-1400				SEC02-T06S-R27E
AMC 430771	ROCKSTAR 057	2015-1401				SEC02-T06S-R27E
AMC 430772	ROCKSTAR 058	2015-1402				SEC02-T06S-R27E
AMC 430773	ROCKSTAR 059	2015-1403				SEC02-T06S-R27E
AMC 430774	ROCKSTAR 060	2015-1404				SEC02-T06S-R27E
AMC 430775	ROCKSTAR 061	2015-1405				SEC02-T06S-R27E
AMC 430776	ROCKSTAR 062	2015-1406				SEC02-T06S-R27E
AMC 430777	ROCKSTAR 063	2015-1407				SEC02-T06S-R27E
AMC 430778	ROCKSTAR 064	2015-1408				SEC02-T06S-R27E
AMC 430779	ROCKSTAR 065	2015-1409				SEC02-T06S-R27E
AMC 430780	ROCKSTAR 066	2015-1410				SEC02-T06S-R27E
AMC 430781	ROCKSTAR 067	2015-1411				SEC02-T06S-R27E
AMC 430782	ROCKSTAR 068	2015-1412				SEC02-T06S-R27E
AMC 430783	ROCKSTAR 069	2015-1413				SEC02-T06S-R27E
AMC 430784	ROCKSTAR 070	2015-1414				SEC02-T06S-R27E
AMC 430785	ROCKSTAR 071	2015-1415				SEC02-T06S-R27E
AMC 430786	ROCKSTAR 072	2015-1416				SEC02-T06S-R27E
AMC 430787	ROCKSTAR 073	2015-1417				SEC03-T06S-R27E
AMC 430788	ROCKSTAR 074	2015-1418				SEC03-T06S-R27E
AMC 430789	ROCKSTAR 075	2015-1419				SEC03-T06S-R27E

Date: 6/1/2017

RECEIVED  
BLM AZ STATE OFFICE  
2017 JUL 12 A 10:11  
PHOENIX, ARIZONA



## Exhibit A

County: Graham

State: AZ

<u>BLM Serial #</u>	<u>Claim Name</u>	<u>Original Recording</u>		<u>Amended Recording</u>		<u>Location</u>
		<u>Recording #</u>	<u>Page #</u>	<u>Recording #</u>	<u>Page #</u>	
AMC 430790	ROCKSTAR 076	2015-1420				SEC03-T06S-R27E
AMC 430791	ROCKSTAR 077	2015-1421				SEC03-T06S-R27E
AMC 430792	ROCKSTAR 078	2015-1422				SEC03-T06S-R27E
AMC 430793	ROCKSTAR 079	2015-1423				SEC03-T06S-R27E
AMC 430794	ROCKSTAR 080	2015-1424				SEC03-T06S-R27E
AMC 430795	ROCKSTAR 081	2015-1425				SEC03-T06S-R27E
AMC 430796	ROCKSTAR 082	2015-1426				SEC03-T06S-R27E
AMC 430797	ROCKSTAR 083	2015-1427				SEC03-T06S-R27E
AMC 430798	ROCKSTAR 084	2015-1428				SEC03-T06S-R27E
AMC 430799	ROCKSTAR 085	2015-1429				SEC03-T06S-R27E
AMC 430800	ROCKSTAR 086	2015-1430				SEC03-T06S-R27E
AMC 430801	ROCKSTAR 087	2015-1431				SEC03-T06S-R27E
AMC 430802	ROCKSTAR 088	2015-1432				SEC03-T06S-R27E
AMC 430803	ROCKSTAR 089	2015-1433				SEC03-T06S-R27E
AMC 430804	ROCKSTAR 090	2015-1434				SEC03-T06S-R27E
AMC 430805	ROCKSTAR 091	2015-1435				SEC12-T06S-R27E
AMC 430806	ROCKSTAR 092	2015-1436				SEC12-T06S-R27E
AMC 430807	ROCKSTAR 093	2015-1437				SEC12-T06S-R27E
AMC 430808	ROCKSTAR 094	2015-1438				SEC12-T06S-R27E
AMC 430809	ROCKSTAR 095	2015-1439				SEC12-T06S-R27E
AMC 430810	ROCKSTAR 096	2015-1440				SEC12-T06S-R27E
AMC 430811	ROCKSTAR 097	2015-1441				SEC12-T06S-R27E
AMC 430812	ROCKSTAR 098	2015-1442				SEC12-T06S-R27E
AMC 430813	ROCKSTAR 099	2015-1443				SEC12-T06S-R27E
AMC 430814	ROCKSTAR 100	2015-1444				SEC12-T06S-R27E
AMC 430815	ROCKSTAR 101	2015-1445				SEC12-T06S-R27E
AMC 430816	ROCKSTAR 102	2015-1446				SEC12-T06S-R27E
AMC 430817	ROCKSTAR 103	2015-1447				SEC12-T06S-R27E
AMC 430818	ROCKSTAR 104	2015-1448				SEC12-T06S-R27E
AMC 430819	ROCKSTAR 105	2015-1449				SEC12-T06S-R27E
AMC 430820	ROCKSTAR 106	2015-1450				SEC12-T06S-R27E
AMC 430821	ROCKSTAR 107	2015-1451				SEC12-T06S-R27E
AMC 430822	ROCKSTAR 108	2015-1452				SEC12-T06S-R27E
AMC 430823	ROCKSTAR 109	2015-1453				SEC12-T06S-R27E
AMC 430824	ROCKSTAR 110	2015-1454				SEC12-T06S-R27E
AMC 430825	ROCKSTAR 111	2015-1455				SEC12-T06S-R27E
AMC 430826	ROCKSTAR 112	2015-1456				SEC12-T06S-R27E
AMC 430827	ROCKSTAR 113	2015-1457				SEC12-T06S-R26E

Date: 6/1/2017

RECEIVED  
BLM AZ STATE OFFICE  
2017 JUL 12 A 10:11  
PHOENIX, ARIZONA

## Exhibit A

County: Graham

State: AZ

BLM Serial #	Claim Name	Original Recording		Amended Recording		Location
		Recording #	Page #	Recording #	Page #	
AMC 430828	ROCKSTAR 114	2015-1458				SEC12-T06S-R26E
AMC 430829	ROCKSTAR 115	2015-1459				SEC12-T06S-R27E
AMC 430830	ROCKSTAR 116	2015-1460				SEC12-T06S-R27E
AMC 430831	ROCKSTAR 117	2015-1461				SEC12-T06S-R27E
AMC 430832	ROCKSTAR 118	2015-1462				SEC12-T06S-R27E
AMC 430833	ROCKSTAR 119	2015-1463				SEC12-T06S-R27E
AMC 430834	ROCKSTAR 120	2015-1464				SEC12-T06S-R27E
AMC 430835	ROCKSTAR 121	2015-1465				SEC12-T06S-R27E
AMC 430836	ROCKSTAR 122	2015-1466				SEC13-T06S-R27E
AMC 430889	Red Bull-1	2015-1696				SEC27-T05S-R25E
AMC 430890	Red Bull-2	2015-1697				SEC27-T05S-R25E
AMC 430891	Red Bull-3	2015-1698				SEC27-T05S-R25E
AMC 430892	Red Bull-4	2015-1699				SEC27-T05S-R25E
AMC 430893	Red Bull-5	2015-1700				SEC27-T05S-R25E
AMC 430894	Red Bull-6	2015-1701				SEC27-T05S-R25E
AMC 430895	Red Bull-7	2015-1702				SEC27-T05S-R25E
AMC 430896	Red Bull-8	2015-1703				SEC27-T05S-R25E
AMC 430897	Red Bull-9	2015-1704				SEC27-T05S-R25E
AMC 430898	Red Bull-10	2015-1705				SEC27-T05S-R25E
AMC 430899	Red Bull-11	2015-1706				SEC27-T05S-R25E
AMC 430900	Red Bull-12	2015-1707				SEC27-T05S-R25E
AMC 430901	Red Bull-13	2015-1708				SEC27-T05S-R25E
AMC 430902	Red Bull-14	2015-1709				SEC27-T05S-R25E
AMC 430903	Red Bull-15	2015-1710				SEC27-T05S-R25E
AMC 430904	Red Bull-16	2015-1711				SEC27-T05S-R25E
AMC 430905	Red Bull-17	2015-1712				SEC27-T05S-R25E
AMC 430906	Red Bull-18	2015-1713				SEC27-T05S-R25E
AMC 430907	Red Bull-19	2015-1714				SEC27-T05S-R25E
AMC 430908	Red Bull-20	2015-1715				SEC27-T05S-R25E
AMC 430909	Red Bull-21	2015-1716				SEC27-T05S-R25E
AMC 430910	Red Bull-22	2015-1717				SEC27-T05S-R25E
AMC 430911	Red Bull-23	2015-1718				SEC27-T05S-R25E
AMC 430912	Red Bull-24	2015-1719				SEC27-T05S-R25E
AMC 430913	Red Bull-25	2015-1720				SEC27-T05S-R25E
AMC 430914	Red Bull-26	2015-1721				SEC27-T05S-R25E
AMC 430915	Red Bull-27	2015-1722				SEC27-T05S-R25E
AMC 430916	Red Bull-28	2015-1723				SEC27-T05S-R25E
AMC 430917	Red Bull-29	2015-1724				SEC27-T05S-R25E

Date: 6/1/2017

RECEIVED  
BLMAZ STATE OFFICE  
2017 JUL 12 A 10:01  
PHOENIX, ARIZO

## Exhibit A

County: Graham

State: AZ

<u>BLM Serial #</u>	<u>Claim Name</u>	<u>Original Recording</u>		<u>Amended Recording</u>		<u>Location</u>
		<u>Recording #</u>	<u>Page #</u>	<u>Recording #</u>	<u>Page #</u>	
AMC 430918	Red Bull-30	2015-1725				SEC27-T05S-R25E
AMC 430919	Red Bull-31	2015-1726				SEC27-T05S-R25E
AMC 430920	Red Bull-32	2015-1727				SEC27-T05S-R25E
AMC 430921	Red Bull-33	2015-1728				SEC27-T05S-R25E
AMC 430922	Red Bull-34	2015-1729				SEC27-T05S-R25E
AMC 430923	Red Bull-35	2015-1730				SEC27-T05S-R25E
AMC 430924	Red Bull-36	2015-1731				SEC27-T05S-R25E
AMC 430925	Red Bull-37	2015-1732				SEC34-T05S-R25E
AMC 430926	Red Bull-38	2015-1733				SEC34-T05S-R25E
AMC 430927	Red Bull-39	2015-1734				SEC34-T05S-R25E
AMC 430928	Red Bull-40	2015-1735				SEC34-T05S-R25E
AMC 430929	Red Bull-41	2015-1736				SEC34-T05S-R25E
AMC 430930	Red Bull-42	2015-1737				SEC34-T05S-R25E
AMC 430931	Red Bull-43	2015-1738				SEC34-T05S-R25E
AMC 430932	Red Bull-44	2015-1739				SEC34-T05S-R25E
AMC 430933	Red Bull-45	2015-1740				SEC34-T05S-R25E
AMC 430934	Red Bull-46	2015-1741				SEC34-T05S-R25E
AMC 430935	Red Bull-47	2015-1742				SEC34-T05S-R25E
AMC 430936	Red Bull-48	2015-1743				SEC34-T05S-R25E
AMC 430937	Red Bull-49	2015-1744				SEC34-T05S-R25E
AMC 430938	Red Bull-50	2015-1745				SEC34-T05S-R25E
AMC 430939	Red Bull-51	2015-1746				SEC34-T05S-R25E
AMC 430940	Red Bull-52	2015-1747				SEC34-T05S-R25E
AMC 430941	Red Bull-53	2015-1748				SEC34-T05S-R25E
AMC 430942	Red Bull-54	2015-1749				SEC34-T05S-R25E
AMC 430943	Red Bull-55	2015-1750				SEC34-T05S-R25E
AMC 430944	Red Bull-56	2015-1751				SEC34-T05S-R25E
AMC 430945	Red Bull-57	2015-1752				SEC34-T05S-R25E
AMC 430946	Red Bull-58	2015-1753				SEC34-T05S-R25E
AMC 430947	Red Bull-59	2015-1754				SEC34-T05S-R25E
AMC 430948	Red Bull-60	2015-1755				SEC34-T05S-R25E
AMC 430949	Red Bull-61	2015-1756				SEC34-T05S-R25E
AMC 430950	Red Bull-62	2015-1757				SEC34-T05S-R25E
AMC 430951	Red Bull-63	2015-1758				SEC34-T05S-R25E
AMC 430952	Red Bull-64	2015-1759				SEC34-T05S-R25E
AMC 430953	Red Bull-65	2015-1760				SEC34-T05S-R25E
AMC 430954	Red Bull-66	2015-1761				SEC34-T05S-R25E
AMC 430955	Red Bull-67	2015-1762				SEC34-T05S-R25E

Date: 6/1/2017

RECEIVED  
 BLM AZ STATE OFFICE  
 2017 JUL 12 A 10:42  
 PHOENIX, ARIZO

## Exhibit A

County: Graham

State: AZ

<u>BLM Serial #</u>	<u>Claim Name</u>	<u>Original Recording</u>		<u>Amended Recording</u>		<u>Location</u>
		<u>Recording #</u>	<u>Page #</u>	<u>Recording #</u>	<u>Page #</u>	
AMC 430956	Red Bull-68	2015-1763				SEC34-T05S-R25E
AMC 430957	Red Bull-69	2015-1764				SEC34-T05S-R25E
AMC 430958	Red Bull-70	2015-1765				SEC34-T05S-R25E
AMC 430959	Red Bull-71	2015-1766				SEC34-T05S-R25E
AMC 430960	Red Bull-72	2015-1767				SEC34-T05S-R25E
AMC 430961	Red Bull-73	2015-1768				SEC33-T05S-R25E
AMC 430962	Red Bull-74	2015-1769				SEC33-T05S-R25E
AMC 430963	Red Bull-75	2015-1770				SEC33-T05S-R25E
AMC 430964	Red Bull-76	2015-1771				SEC33-T05S-R25E
AMC 430965	Red Bull-77	2015-1772				SEC33-T05S-R25E
AMC 430966	Red Bull-78	2015-1773				SEC33-T05S-R25E
AMC 430967	Red Bull-79	2015-1774				SEC33-T05S-R25E
AMC 430968	Red Bull-80	2015-1775				SEC33-T05S-R25E
AMC 430969	Red Bull-81	2015-1776				SEC33-T05S-R25E
AMC 430970	Red Bull-82	2015-1777				SEC33-T05S-R25E
AMC 430971	Red Bull-83	2015-1778				SEC33-T05S-R25E
AMC 430972	Red Bull-84	2015-1779				SEC33-T05S-R25E
AMC 430973	Red Bull-85	2015-1780				SEC33-T05S-R25E
AMC 430974	Red Bull-86	2015-1781				SEC33-T05S-R25E
AMC 430975	Red Bull-87	2015-1782				SEC33-T05S-R25E
AMC 430976	Red Bull-88	2015-1783				SEC33-T05S-R25E
AMC 430977	Red Bull-89	2015-1784				SEC33-T05S-R25E
AMC 430978	Red Bull-90	2015-1785				SEC33-T05S-R25E
AMC 430979	Red Bull-91	2015-1786				SEC33-T05S-R25E
AMC 430980	Red Bull-92	2015-1787				SEC33-T05S-R25E
AMC 430981	Red Bull-93	2015-1788				SEC33-T05S-R25E
AMC 430982	Red Bull-94	2015-1789				SEC33-T05S-R25E
AMC 430983	Red Bull-95	2015-1790				SEC33-T05S-R25E
AMC 430984	Red Bull-96	2015-1791				SEC33-T05S-R25E
AMC 430985	Red Bull-97	2015-1792				SEC33-T05S-R25E
AMC 430986	Red Bull-98	2015-1793				SEC33-T05S-R25E
AMC 430987	Red Bull-99	2015-1794				SEC33-T05S-R25E
AMC 430988	Red Bull-100	2015-1795				SEC33-T05S-R25E
AMC 430989	Red Bull-101	2015-1796				SEC33-T05S-R25E
AMC 430990	Red Bull-102	2015-1797				SEC33-T05S-R25E
AMC 430991	Red Bull-103	2015-1798				SEC33-T05S-R25E
AMC 430992	Red Bull-104	2015-1799				SEC33-T05S-R25E
AMC 430993	Red Bull-105	2015-1800				SEC33-T05S-R25E

Date: 6/1/2017

RECEIVED  
BLM AZ STATE OFFICE  
2017 JUL 12 A 10:42  
PHOENIX, ARIZONA

## Exhibit A

County: Graham

State: AZ

<u>BLM Serial #</u>	<u>Claim Name</u>	<u>Original Recording</u>		<u>Amended Recording</u>		<u>Location</u>
		<u>Recording #</u>	<u>Page #</u>	<u>Recording #</u>	<u>Page #</u>	
AMC 430994	Red Bull-106	2015-1801				SEC33-T05S-R25E
AMC 430995	Red Bull-107	2015-1802				SEC33-T05S-R25E
AMC 430996	Red Bull-108	2015-1803				SEC33-T05S-R25E
AMC 430997	Red Bull-109	2015-1804				SEC28-T05S-R25E
AMC 430998	Red Bull-110	2015-1805				SEC28-T05S-R25E
AMC 430999	Red Bull-111	2015-1806				SEC28-T05S-R25E
AMC 431000	Red Bull-112	2015-1807				SEC28-T05S-R25E
AMC 431001	Red Bull-113	2015-1808				SEC28-T05S-R25E
AMC 431002	Red Bull-114	2015-1809				SEC28-T05S-R25E
AMC 431003	Red Bull-115	2015-1810				SEC28-T05S-R25E
AMC 431004	Red Bull-116	2015-1811				SEC28-T05S-R25E
AMC 431005	Red Bull-117	2015-1812				SEC28-T05S-R25E
AMC 431006	Red Bull-118	2015-1813				SEC28-T05S-R25E
AMC 431007	Red Bull-119	2015-1814				SEC28-T05S-R25E
AMC 431008	Red Bull-120	2015-1815				SEC28-T05S-R25E
AMC 431009	Red Bull-121	2015-1816				SEC28-T05S-R25E
AMC 431010	Red Bull-122	2015-1817				SEC28-T05S-R25E
AMC 431011	Red Bull-123	2015-1818				SEC28-T05S-R25E
AMC 431012	Red Bull-124	2015-1819				SEC28-T05S-R25E
AMC 431013	Red Bull-125	2015-1820				SEC28-T05S-R25E
AMC 431014	Red Bull-126	2015-1821				SEC28-T05S-R25E
AMC 431015	Red Bull-127	2015-1822				SEC28-T05S-R25E
AMC 431016	Red Bull-128	2015-1823				SEC28-T05S-R25E
AMC 431017	Red Bull-129	2015-1824				SEC28-T05S-R25E
AMC 431018	Red Bull-130	2015-1825				SEC28-T05S-R25E
AMC 431019	Red Bull-131	2015-1826				SEC28-T05S-R25E
AMC 431020	Red Bull-132	2015-1827				SEC28-T05S-R25E
AMC 431021	Red Bull-133	2015-1828				SEC28-T05S-R25E
AMC 431022	Red Bull-134	2015-1829				SEC28-T05S-R25E
AMC 431023	Red Bull-135	2015-1830				SEC28-T05S-R25E
AMC 431024	Red Bull-136	2015-1831				SEC28-T05S-R25E
AMC 431025	Red Bull-137	2015-1832				SEC28-T05S-R25E
AMC 431026	Red Bull-138	2015-1833				SEC28-T05S-R25E
AMC 431027	Red Bull-139	2015-1834				SEC28-T05S-R25E
AMC 431028	Red Bull-140	2015-1835				SEC28-T05S-R25E
AMC 431029	Red Bull-141	2015-1836				SEC28-T05S-R25E
AMC 431030	Red Bull-142	2015-1837				SEC28-T05S-R25E
AMC 431031	Red Bull-143	2015-1838				SEC28-T05S-R25E

Date: 6/1/2017

RECEIVED  
BEMAH STATE OFFICE  
2017 JUL 12 A 10:42  
PHOENIX, ARIZONA

## Exhibit A

County: Graham

State: AZ

BLM Serial #	Claim Name	Original Recording		Amended Recording		Location
		Recording #	Page #	Recording #	Page #	
AMC 431032 <sup>7</sup>	Red Bull-144	2015-1839				SEC28-T05S-R25E
AMC 431033	Red Bull-316	2015-1840				SEC16-T05S-R25E
AMC 431034	Red Bull-317	2015-1841				SEC16-T05S-R25E
AMC 431035	Red Bull-318	2015-1842				SEC16-T05S-R25E
AMC 431036	Red Bull-319	2015-1843				SEC16-T05S-R25E
AMC 431037	Red Bull-320	2015-1844				SEC16-T05S-R25E
AMC 431038	Red Bull-321	2015-1845				SEC16-T05S-R25E
AMC 431039	Red Bull-322	2015-1846				SEC16-T05S-R25E
AMC 431040	Red Bull-323	2015-1847				SEC16-T05S-R25E
AMC 431041	Red Bull-324	2015-1848				SEC16-T05S-R25E
AMC 431042	Red Bull-325	2015-1849				SEC16-T05S-R25E
AMC 431043	Red Bull-326	2015-1850				SEC16-T05S-R25E
AMC 431044	Red Bull-327	2015-1851				SEC16-T05S-R25E
AMC 431045	Red Bull-328	2015-1852				SEC16-T05S-R25E
AMC 431046	Red Bull-329	2015-1853				SEC16-T05S-R25E
AMC 431047	Red Bull-330	2015-1854				SEC16-T05S-R25E
AMC 431048	Red Bull-331	2015-1855				SEC16-T05S-R25E
AMC 431049	Red Bull-332	2015-1856				SEC16-T05S-R25E
AMC 431050	Red Bull-333	2015-1857				SEC16-T05S-R25E
AMC 431051	Red Bull-334	2015-1858				SEC16-T05S-R25E
AMC 431052	Red Bull-335	2015-1859				SEC16-T05S-R25E
AMC 431053	Red Bull-336	2015-1860				SEC16-T05S-R25E
AMC 431054	Red Bull-337	2015-1861				SEC16-T05S-R25E
AMC 431055	Red Bull-338	2015-1862				SEC16-T05S-R25E
AMC 431056	Red Bull-339	2015-1863				SEC16-T05S-R25E
AMC 431057	Red Bull-340	2015-1864				SEC16-T05S-R25E
AMC 431058	Red Bull-341	2015-1865				SEC16-T05S-R25E
AMC 431059	Red Bull-342	2015-1866				SEC16-T05S-R25E
AMC 431060	Red Bull-343	2015-1867				SEC16-T05S-R25E
AMC 431061	Red Bull-344	2015-1868				SEC16-T05S-R25E
AMC 431062	Red Bull-345	2015-1869				SEC16-T05S-R25E
AMC 431063	Red Bull-346	2015-1870				SEC16-T05S-R25E
AMC 431064	Red Bull-347	2015-1871				SEC16-T05S-R25E
AMC 431065	Red Bull-348	2015-1872				SEC16-T05S-R25E
AMC 431066	Red Bull-349	2015-1873				SEC16-T05S-R25E
AMC 431067	Red Bull-350	2015-1874				SEC16-T05S-R25E
AMC 431068	Red Bull-351	2015-1875				SEC16-T05S-R25E
AMC 431071	ROCKSTAR 123	2015-1913				SEC13-T06S-R27E

Date: 6/1/2017

RECEIVED  
 BLM AZ STATE OFFICE  
 2017 JUL 12 A 10:42  
 PHOENIX, ARIZONA

## Exhibit A

County: Graham

State: AZ

<u>BLM Serial #</u>	<u>Claim Name</u>	<u>Original Recording</u>		<u>Amended Recording</u>		<u>Location</u>
		<u>Recording #</u>	<u>Page #</u>	<u>Recording #</u>	<u>Page #</u>	
AMC 431072	ROCKSTAR 124	2015-1914				SEC13-T06S-R27E
AMC 431073	ROCKSTAR 125	2015-1915				SEC13-T06S-R27E
AMC 431074	ROCKSTAR 126	2015-1916				SEC24-T06S-R27E
AMC 431075	ROCKSTAR 127	2015-1917				SEC13-T06S-R27E
AMC 431076	ROCKSTAR 128	2015-1918				SEC13-T06S-R27E
AMC 431077	ROCKSTAR 129	2015-1919				SEC13-T06S-R27E
AMC 431078	ROCKSTAR 130	2015-1920				SEC13-T06S-R27E
AMC 431079	ROCKSTAR 131	2015-1921				SEC13-T06S-R27E
AMC 431080	ROCKSTAR 132	2015-1922				SEC13-T06S-R27E
AMC 431081	ROCKSTAR 133	2015-1923				SEC13-T06S-R27E
AMC 431082	ROCKSTAR 134	2015-1924				SEC13-T06S-R27E
AMC 431083	ROCKSTAR 135	2015-1925				SEC13-T06S-R27E
AMC 431084	ROCKSTAR 136	2015-1926				SEC13-T06S-R27E
AMC 431085	ROCKSTAR 137	2015-1927				SEC13-T06S-R27E
AMC 431086	ROCKSTAR 138	2015-1928				SEC13-T06S-R27E
AMC 431087	ROCKSTAR 139	2015-1929				SEC13-T06S-R27E
AMC 431088	ROCKSTAR 140	2015-1930				SEC13-T06S-R27E
AMC 431089	ROCKSTAR 141	2015-1931				SEC13-T06S-R27E
AMC 431090	ROCKSTAR 142	2015-1932				SEC13-T06S-R27E
AMC 431091	ROCKSTAR 143	2015-1933				SEC13-T06S-R27E
AMC 431092	ROCKSTAR 144	2015-1934				SEC13-T06S-R27E
AMC 431093	ROCKSTAR 145	2015-1935				SEC13-T06S-R27E
AMC 431094	ROCKSTAR 146	2015-1936				SEC13-T06S-R27E
AMC 431095	ROCKSTAR 147	2015-1937				SEC13-T06S-R27E
AMC 431096	ROCKSTAR 148	2015-1938				SEC13-T06S-R27E
AMC 431097	ROCKSTAR 149	2015-1939				SEC13-T06S-R27E
AMC 431098	ROCKSTAR 150	2015-1940				SEC13-T06S-R27E
AMC 431099	ROCKSTAR 151	2015-1941				SEC24-T06S-R27E
AMC 431100	ROCKSTAR 152	2015-1942				SEC24-T06S-R27E
AMC 431101	ROCKSTAR 153	2015-1943				SEC24-T06S-R27E
AMC 431102	ROCKSTAR 154	2015-1944				SEC24-T06S-R27E
AMC 431103	ROCKSTAR 155	2015-1945				SEC24-T06S-R27E
AMC 431104	ROCKSTAR 156	2015-1946				SEC24-T06S-R27E
AMC 431105	ROCKSTAR 157	2015-1947				SEC24-T06S-R27E
AMC 431106	ROCKSTAR 158	2015-1948				SEC24-T06S-R27E
AMC 431107	ROCKSTAR 159	2015-1949				SEC24-T06S-R27E
AMC 431108	ROCKSTAR 160	2015-1950				SEC24-T06S-R27E
AMC 431109	ROCKSTAR 161	2015-1951				SEC24-T06S-R27E

Date: 6/1/2017

RECEIVED  
 BLM AZ STATE OFFICE  
 PHOENIX, ARIZONA  
 2017 JUL 12 A 10:44

## Exhibit A

County: Graham

State: AZ

Original Recording

Amended Recording

<u>BLM Serial #</u>	<u>Claim Name</u>	<u>Recording #</u>	<u>Page #</u>	<u>Recording #</u>	<u>Page #</u>	<u>Location</u>
AMC 431110	ROCKSTAR 162	2015-1952				SEC24-T06S-R27E
AMC 431111	ROCKSTAR 163	2015-1953				SEC24-T06S-R27E
AMC 431112	ROCKSTAR 164	2015-1954				SEC24-T06S-R27E
AMC 431113	ROCKSTAR 165	2015-1955				SEC24-T06S-R27E
AMC 431114	ROCKSTAR 166	2015-1956				SEC24-T06S-R27E
AMC 431115	ROCKSTAR 167	2015-1957				SEC24-T06S-R27E
AMC 431116	ROCKSTAR 168	2015-1958				SEC24-T06S-R27E
AMC 431117	ROCKSTAR 169	2015-1959				SEC24-T06S-R27E
AMC 431118	ROCKSTAR 170	2015-1960				SEC24-T06S-R27E
AMC 431119	ROCKSTAR 171	2015-1961				SEC24-T06S-R27E
AMC 431120	ROCKSTAR 172	2015-1962				SEC23-T06S-R27E
AMC 431121	MONSTER-001	2015-1963				SEC30-T05S-R27E
AMC 431122	MONSTER-002	2015-1964				SEC30-T05S-R27E
AMC 431123	MONSTER-003	2015-1965				SEC30-T05S-R27E
AMC 431124	MONSTER-004	2015-1966				SEC30-T05S-R27E
AMC 431125	MONSTER-005	2015-1967				SEC30-T05S-R27E
AMC 431126	MONSTER-006	2015-1968				SEC30-T05S-R27E
AMC 431127	MONSTER-007	2015-1969				SEC30-T05S-R27E
AMC 431128	MONSTER-008	2015-1970				SEC30-T05S-R27E
AMC 431129	MONSTER-009	2015-1971				SEC30-T05S-R27E
AMC 431130	MONSTER-010	2015-1972				SEC30-T05S-R27E
AMC 431131	MONSTER-011	2015-1973				SEC30-T05S-R27E
AMC 431132	MONSTER-012	2015-1974				SEC30-T05S-R27E
AMC 431133	MONSTER-013	2015-1975				SEC30-T05S-R27E
AMC 431134	MONSTER-014	2015-1976				SEC30-T05S-R27E
AMC 431135	MONSTER-015	2015-1977				SEC30-T05S-R27E
AMC 431136	MONSTER-016	2015-1978				SEC30-T05S-R27E
AMC 431137	MONSTER-017	2015-1979				SEC30-T05S-R27E
AMC 431138	MONSTER-018	2015-1980				SEC30-T05S-R27E
AMC 431139	MONSTER-019	2015-1981				SEC30-T05S-R27E
AMC 431140	MONSTER-020	2015-1982				SEC30-T05S-R27E
AMC 431141	MONSTER-021	2015-1983				SEC30-T05S-R27E
AMC 431142	MONSTER-022	2015-1984				SEC30-T05S-R27E
AMC 431143	MONSTER-023	2015-1985				SEC30-T05S-R27E
AMC 431144	MONSTER-024	2015-1986				SEC30-T05S-R27E
AMC 431145	MONSTER-025	2015-1987				SEC30-T05S-R27E
AMC 431146	MONSTER-026	2015-1988				SEC30-T05S-R27E
AMC 431147	MONSTER-027	2015-1989				SEC30-T05S-R27E

Date: 6/1/2017

RECEIVED  
BLM AZ STATE OFFICE  
2017 JUL 12 A 10:44  
PHOENIX, ARIZONA



## Exhibit A

County: Graham

State: AZ

<u>BLM Serial #</u>	<u>Claim Name</u>	<u>Original Recording</u>		<u>Amended Recording</u>		<u>Location</u>
		<u>Recording #</u>	<u>Page #</u>	<u>Recording #</u>	<u>Page #</u>	
AMC 431148	MONSTER-028	2015-1990				SEC30-T05S-R27E
AMC 431149	MONSTER-029	2015-1991				SEC30-T05S-R27E
AMC 431150	MONSTER-030	2015-1992				SEC30-T05S-R27E
AMC 431151	MONSTER-031	2015-1993				SEC30-T05S-R27E
AMC 431152	MONSTER-032	2015-1994				SEC30-T05S-R27E
AMC 431153	MONSTER-033	2015-1995				SEC30-T05S-R27E
AMC 431154	MONSTER-034	2015-1996				SEC30-T05S-R27E
AMC 431155	MONSTER-035	2015-1997				SEC30-T05S-R27E
AMC 431156	MONSTER-036	2015-1998				SEC30-T05S-R27E
AMC 431157	MONSTER-037	2015-1999				SEC29-T05S-R27E
AMC 431158	MONSTER-038	2015-2000				SEC29-T05S-R27E
AMC 431159	MONSTER-039	2015-2001				SEC29-T05S-R27E
AMC 431160	MONSTER-040	2015-2002				SEC29-T05S-R27E
AMC 431161	MONSTER-041	2015-2003				SEC29-T05S-R27E
AMC 431162	MONSTER-042	2015-2004				SEC29-T05S-R27E
AMC 431163	MONSTER-043	2015-2005				SEC29-T05S-R27E
AMC 431164	MONSTER-044	2015-2006				SEC29-T05S-R27E
AMC 431165	MONSTER-045	2015-2007				SEC29-T05S-R27E
AMC 431166	MONSTER-046	2015-2008				SEC29-T05S-R27E
AMC 431167	MONSTER-047	2015-2009				SEC29-T05S-R27E
AMC 431168	MONSTER-048	2015-2010				SEC29-T05S-R27E
AMC 431169	MONSTER-049	2015-2011				SEC29-T05S-R27E
AMC 431170	MONSTER-050	2015-2012				SEC29-T05S-R27E
AMC 431171	MONSTER-051	2015-2013				SEC29-T05S-R27E
AMC 431172	MONSTER-052	2015-2014				SEC29-T05S-R27E
AMC 431173	MONSTER-053	2015-2015				SEC29-T05S-R27E
AMC 431174	MONSTER-054	2015-2016				SEC29-T05S-R27E
AMC 431175	MONSTER-055	2015-2017				SEC29-T05S-R27E
AMC 431176	MONSTER-056	2015-2018				SEC29-T05S-R27E
AMC 431177	MONSTER-057	2015-2019				SEC29-T05S-R27E
AMC 431178	MONSTER-058	2015-2020				SEC29-T05S-R27E
AMC 431179	MONSTER-059	2015-2021				SEC29-T05S-R27E
AMC 431180	MONSTER-060	2015-2022				SEC29-T05S-R27E
AMC 431181	MONSTER-061	2015-2023				SEC29-T05S-R27E
AMC 431182	MONSTER-062	2015-2024				SEC29-T05S-R27E
AMC 431183	MONSTER-063	2015-2025				SEC29-T05S-R27E
AMC 431184	MONSTER-064	2015-2026				SEC29-T05S-R27E
AMC 431185	MONSTER-065	2015-2027				SEC29-T05S-R27E

Date: 6/1/2017

RECEIVED  
BLM AZ STATE OFFICE

PHOENIX, ARIZONA  
2017 JUL 12 A 10:41

# Exhibit A

County: Graham

State: AZ

Original Recording

Amended Recording

<u>BLM Serial #</u>	<u>Claim Name</u>	<u>Recording #</u>	<u>Page #</u>	<u>Recording #</u>	<u>Page #</u>	<u>Location</u>
AMC 431186	MONSTER-066	2015-2028				SEC29-T05S-R27E
AMC 431187	MONSTER-067	2015-2029				SEC29-T05S-R27E
AMC 431188	MONSTER-068	2015-2030				SEC29-T05S-R27E
AMC 431189	MONSTER-069	2015-2031				SEC29-T05S-R27E
AMC 431190	MONSTER-070	2015-2032				SEC29-T05S-R27E
AMC 431191	MONSTER-071	2015-2033				SEC29-T05S-R27E
AMC 431192	MONSTER-072	2015-2034				SEC29-T05S-R27E
AMC 431193	MONSTER-073	2015-2035				SEC28-T05S-R27E
AMC 431194	MONSTER-074	2015-2036				SEC28-T05S-R27E
AMC 431195	MONSTER-075	2015-2037				SEC28-T05S-R27E
AMC 431196	MONSTER-076	2015-2038				SEC28-T05S-R27E
AMC 431197	MONSTER-077	2015-2039				SEC28-T05S-R27E
AMC 431198	MONSTER-078	2015-2040				SEC28-T05S-R27E
AMC 431199	MONSTER-079	2015-2041				SEC28-T05S-R27E
AMC 431200	MONSTER-080	2015-2042				SEC28-T05S-R27E
AMC 431201	MONSTER-081	2015-2043				SEC28-T05S-R27E
AMC 431202	MONSTER-082	2015-2044				SEC28-T05S-R27E
AMC 431203	MONSTER-083	2015-2045				SEC28-T05S-R27E
AMC 431204	MONSTER-084	2015-2046				SEC28-T05S-R27E
AMC 431205	MONSTER-085	2015-2047				SEC28-T05S-R27E
AMC 431206	MONSTER-086	2015-2048				SEC28-T05S-R27E
AMC 431207	MONSTER-087	2015-2049				SEC28-T05S-R27E
AMC 431208	MONSTER-088	2015-2050				SEC28-T05S-R27E
AMC 431209	MONSTER-089	2015-2051				SEC28-T05S-R27E
AMC 431210	MONSTER-090	2015-2052				SEC28-T05S-R27E
AMC 431211	MONSTER-091	2015-2053				SEC28-T05S-R27E
AMC 431212	MONSTER-092	2015-2054				SEC28-T05S-R27E
AMC 431213	MONSTER-093	2015-2055				SEC28-T05S-R27E
AMC 431214	MONSTER-094	2015-2056				SEC28-T05S-R27E
AMC 431215	MONSTER-095	2015-2057				SEC28-T05S-R27E
AMC 431216	MONSTER-096	2015-2058				SEC28-T05S-R27E
AMC 431217	MONSTER-097	2015-2059				SEC28-T05S-R27E
AMC 431218	MONSTER-098	2015-2060				SEC28-T05S-R27E
AMC 431219	MONSTER-099	2015-2061				SEC28-T05S-R27E
AMC 431220	MONSTER-100	2015-2062				SEC28-T05S-R27E
AMC 431221	MONSTER-101	2015-2063				SEC28-T05S-R27E
AMC 431222	MONSTER-102	2015-2064				SEC28-T05S-R27E
AMC 431223	MONSTER-103	2015-2065				SEC28-T05S-R27E

Date: 6/1/2017

RECEIVED  
BLM AZ STATE OFFICE  
2017 JUL 12 A 10:44  
PHOENIX, ARIZONA

## Exhibit A

County: Graham

State: AZ

Original Recording

Amended Recording

<u>BLM Serial #</u>	<u>Claim Name</u>	<u>Recording #</u>	<u>Page #</u>	<u>Recording #</u>	<u>Page #</u>	<u>Location</u>
AMC 431224	MONSTER-104	2015-2066				SEC28-T05S-R27E
AMC 431225	MONSTER-105	2015-2067				SEC28-T05S-R27E
AMC 431226	MONSTER-106	2015-2068				SEC28-T05S-R27E
AMC 431227	MONSTER-107	2015-2069				SEC28-T05S-R27E
AMC 431228	MONSTER-108	2015-2070				SEC28-T05S-R27E
AMC 431229	MONSTER-149	2015-2071				SEC34-T05S-R27E
AMC 431230	MONSTER-150	2015-2072				SEC34-T05S-R27E
AMC 431231	MONSTER-159	2015-2073				SEC34-T05S-R27E
AMC 431232	MONSTER-160	2015-2074				SEC34-T05S-R27E
AMC 431233	MONSTER-161	2015-2075				SEC34-T05S-R27E
AMC 431234	MONSTER-162	2015-2076				SEC34-T05S-R27E
AMC 431235	MONSTER-163	2015-2077				SEC34-T05S-R27E
AMC 431236	MONSTER-164	2015-2078				SEC34-T05S-R27E
AMC 431237	MONSTER-165	2015-2079				SEC34-T05S-R27E
AMC 431238	MONSTER-166	2015-2080				SEC34-T05S-R27E
AMC 431239	MONSTER-167	2015-2081				SEC34-T05S-R27E
AMC 431240	MONSTER-168	2015-2082				SEC34-T05S-R27E
AMC 431241	MONSTER-169	2015-2083				SEC34-T05S-R27E
AMC 431242	MONSTER-170	2015-2084				SEC34-T05S-R27E
AMC 431243	MONSTER-171	2015-2085				SEC34-T05S-R27E
AMC 431244	MONSTER-172	2015-2086				SEC34-T05S-R27E
AMC 431245	MONSTER-173	2015-2087				SEC34-T05S-R27E
AMC 431246	MONSTER-174	2015-2088				SEC34-T05S-R27E
AMC 431247	MONSTER-175	2015-2089				SEC34-T05S-R27E
AMC 431248	MONSTER-176	2015-2090				SEC34-T05S-R27E
AMC 431249	MONSTER-331	2015-2091				SEC19-T05S-R27E
AMC 431250	MONSTER-332	2015-2092				SEC19-T05S-R27E
AMC 431251	MONSTER-333	2015-2093				SEC19-T05S-R27E
AMC 431252	MONSTER-334	2015-2094				SEC19-T05S-R27E
AMC 431253	MONSTER-335	2015-2095				SEC19-T05S-R27E
AMC 431254	MONSTER-336	2015-2096				SEC19-T05S-R27E
AMC 431255	MONSTER-337	2015-2097				SEC19-T05S-R27E
AMC 431256	MONSTER-338	2015-2098				SEC19-T05S-R27E
AMC 431257	MONSTER-339	2015-2099				SEC19-T05S-R27E
AMC 431258	MONSTER-340	2015-2100				SEC19-T05S-R27E
AMC 431259	MONSTER-341	2015-2101				SEC19-T05S-R27E
AMC 431260	MONSTER-342	2015-2102				SEC19-T05S-R27E
AMC 431261	MONSTER-343	2015-2103				SEC19-T05S-R27E

Date: 6/1/2017

RECEIVED  
BLM AZ STATE OFFICE

PHOENIX, ARIZO

2017 JUL 12 A 10:44

## Exhibit A

County: Graham

State: AZ

<u>BLM Serial #</u>	<u>Claim Name</u>	<u>Original Recording</u>		<u>Amended Recording</u>		<u>Location</u>
		<u>Recording #</u>	<u>Page #</u>	<u>Recording #</u>	<u>Page #</u>	
AMC 431262	MONSTER-344	2015-2104				SEC19-T05S-R27E
AMC 431263	MONSTER-345	2015-2105				SEC19-T05S-R27E
AMC 431264	MONSTER-346	2015-2106				SEC19-T05S-R27E
AMC 431265	MONSTER-347	2015-2107				SEC19-T05S-R27E
AMC 431266	MONSTER-348	2015-2108				SEC19-T05S-R27E
AMC 431267	MONSTER-349	2015-2109				SEC19-T05S-R27E
AMC 431268	MONSTER-350	2015-2110				SEC19-T05S-R27E
AMC 431269	MONSTER-351	2015-2111				SEC19-T05S-R27E
AMC 431270	MONSTER-352	2015-2112				SEC19-T05S-R27E
AMC 431271	MONSTER-353	2015-2113				SEC19-T05S-R27E
AMC 431272	MONSTER-354	2015-2114				SEC19-T05S-R27E
AMC 431273	MONSTER-355	2015-2115				SEC19-T05S-R27E
AMC 431274	MONSTER-356	2015-2116				SEC19-T05S-R27E
AMC 431275	MONSTER-357	2015-2117				SEC19-T05S-R27E
AMC 431276	MONSTER-358	2015-2118				SEC19-T05S-R27E
AMC 431277	MONSTER-359	2015-2119				SEC19-T05S-R27E
AMC 431278	MONSTER-360	2015-2120				SEC19-T05S-R27E
AMC 431279	MONSTER-361	2015-2121				SEC19-T05S-R27E
AMC 431280	MONSTER-362	2015-2122				SEC19-T05S-R27E
AMC 431281	MONSTER-363	2015-2123				SEC19-T05S-R27E
AMC 431282	MONSTER-364	2015-2124				SEC19-T05S-R27E
AMC 431283	MONSTER-365	2015-2125				SEC19-T05S-R27E
AMC 431284	MONSTER-366	2015-2126				SEC19-T05S-R27E
AMC 431317	Red Bull-145	2015-2200				SEC29-T05S-R25E
AMC 431318	Red Bull-146	2015-2201				SEC29-T05S-R25E
AMC 431319	Red Bull-147	2015-2202				SEC29-T05S-R25E
AMC 431320	Red Bull-148	2015-2203				SEC29-T05S-R25E
AMC 431321	Red Bull-149	2015-2204				SEC29-T05S-R25E
AMC 431322	Red Bull-150	2015-2205				SEC29-T05S-R25E
AMC 431323	Red Bull-151	2015-2206				SEC29-T05S-R25E
AMC 431324	Red Bull-152	2015-2207				SEC29-T05S-R25E
AMC 431325	Red Bull-153	2015-2208				SEC29-T05S-R25E
AMC 431326	Red Bull-154	2015-2209				SEC29-T05S-R25E
AMC 431327	Red Bull-155	2015-2210				SEC29-T05S-R25E
AMC 431328	Red Bull-156	2015-2211				SEC29-T05S-R25E
AMC 431329	Red Bull-157	2015-2212				SEC29-T05S-R25E
AMC 431330	Red Bull-158	2015-2213				SEC29-T05S-R25E
AMC 431331	Red Bull-159	2015-2214				SEC29-T05S-R25E

Date: 6/1/2017

RECEIVED  
BLM AZ STATE OFFICE  
2017 JUL 12 A 10:11  
PHOENIX, ARIZO

## Exhibit A

County: Graham

State: AZ

<u>BLM Serial #</u>	<u>Claim Name</u>	<u>Original Recording</u>		<u>Amended Recording</u>		<u>Location</u>
		<u>Recording #</u>	<u>Page #</u>	<u>Recording #</u>	<u>Page #</u>	
AMC 431332	Red Bull-160	2015-2215				SEC29-T05S-R25E
AMC 431333	Red Bull-161	2015-2216				SEC29-T05S-R25E
AMC 431334	Red Bull-162	2015-2217				SEC29-T05S-R25E
AMC 431335	Red Bull-163	2015-2218				SEC29-T05S-R25E
AMC 431336	Red Bull-164	2015-2219				SEC29-T05S-R25E
AMC 431337	Red Bull-165	2015-2220				SEC29-T05S-R25E
AMC 431338	Red Bull-166	2015-2221				SEC29-T05S-R25E
AMC 431339	Red Bull-167	2015-2222				SEC29-T05S-R25E
AMC 431340	Red Bull-168	2015-2223				SEC29-T05S-R25E
AMC 431341	Red Bull-169	2015-2224				SEC29-T05S-R25E
AMC 431342	Red Bull-170	2015-2225				SEC29-T05S-R25E
AMC 431343	Red Bull-171	2015-2226				SEC29-T05S-R25E
AMC 431344	Red Bull-172	2015-2227				SEC29-T05S-R25E
AMC 431345	Red Bull-173	2015-2228				SEC29-T05S-R25E
AMC 431346	Red Bull-174	2015-2229				SEC29-T05S-R25E
AMC 431347	Red Bull-175	2015-2230				SEC29-T05S-R25E
AMC 431348	Red Bull-176	2015-2231				SEC29-T05S-R25E
AMC 431349	Red Bull-177	2015-2232				SEC29-T05S-R25E
AMC 431350	Red Bull-178	2015-2233				SEC29-T05S-R25E
AMC 431351	Red Bull-179	2015-2234				SEC29-T05S-R25E
AMC 431352	Red Bull-180	2015-2235				SEC29-T05S-R25E
AMC 431353	Red Bull-181	2015-2236				SEC30-T05S-R25E
AMC 431354	Red Bull-182	2015-2237				SEC30-T05S-R25E
AMC 431355	Red Bull-183	2015-2238				SEC30-T05S-R25E
AMC 431356	Red Bull-184	2015-2239				SEC30-T05S-R25E
AMC 431357	Red Bull-185	2015-2240				SEC30-T05S-R25E
AMC 431358	Red Bull-186	2015-2241				SEC30-T05S-R25E
AMC 431359	Red Bull-187	2015-2242				SEC30-T05S-R25E
AMC 431360	Red Bull-188	2015-2243				SEC30-T05S-R25E
AMC 431361	Red Bull-189	2015-2244				SEC30-T05S-R25E
AMC 431362	Red Bull-190	2015-2245				SEC30-T05S-R25E
AMC 431363	Red Bull-191	2015-2246				SEC30-T05S-R25E
AMC 431364	Red Bull-192	2015-2247				SEC30-T05S-R25E
AMC 431365	Red Bull-193	2015-2248				SEC30-T05S-R25E
AMC 431366	Red Bull-194	2015-2249				SEC30-T05S-R25E
AMC 431367	Red Bull-195	2015-2250				SEC30-T05S-R25E
AMC 431368	Red Bull-196	2015-2251				SEC30-T05S-R25E
AMC 431369	Red Bull-197	2015-2252				SEC30-T05S-R25E

Date: 6/1/2017

RECEIVED  
BLM AZ STATE OFFICE  
2017 JUL 12 A 10:11  
PHOENIX, ARIZONA

## Exhibit A

County: Graham

State: AZ

<u>BLM Serial #</u>	<u>Claim Name</u>	<u>Original Recording</u>		<u>Amended Recording</u>		<u>Location</u>
		<u>Recording #</u>	<u>Page #</u>	<u>Recording #</u>	<u>Page #</u>	
AMC 431370	Red Bull-198	2015-2253				SEC30-T05S-R25E
AMC 431371	Red Bull-199	2015-2254				SEC30-T05S-R25E
AMC 431372	Red Bull-200	2015-2255				SEC30-T05S-R25E
AMC 431373	Red Bull-201	2015-2256				SEC30-T05S-R25E
AMC 431374	Red Bull-202	2015-2257				SEC30-T05S-R25E
AMC 431375	Red Bull-203	2015-2258				SEC30-T05S-R25E
AMC 431376	Red Bull-204	2015-2259				SEC30-T05S-R25E
AMC 431377	Red Bull-205	2015-2260				SEC30-T05S-R25E
AMC 431378	Red Bull-206	2015-2261				SEC30-T05S-R25E
AMC 431379	Red Bull-207	2015-2262				SEC30-T05S-R25E
AMC 431380	Red Bull-208	2015-2263				SEC30-T05S-R25E
AMC 431381	Red Bull-209	2015-2264				SEC30-T05S-R25E
AMC 431382	Red Bull-210	2015-2265				SEC30-T05S-R25E
AMC 431383	Red Bull-211	2015-2266				SEC30-T05S-R25E
AMC 431384	Red Bull-212	2015-2267				SEC30-T05S-R25E
AMC 431385	Red Bull-213	2015-2268				SEC30-T05S-R25E
AMC 431386	Red Bull-214	2015-2269				SEC30-T05S-R25E
AMC 431387	Red Bull-215	2015-2270				SEC30-T05S-R25E
AMC 431388	Red Bull-216	2015-2271				SEC30-T05S-R25E
AMC 431389	Red Bull-217	2015-2272				SEC19-T05S-R25E
AMC 431390	Red Bull-218	2015-2273				SEC19-T05S-R25E
AMC 431391	Red Bull-219	2015-2274				SEC19-T05S-R25E
AMC 431392	Red Bull-220	2015-2275				SEC19-T05S-R25E
AMC 431393	Red Bull-221	2015-2276				SEC19-T05S-R25E
AMC 431394	Red Bull-222	2015-2277				SEC19-T05S-R25E
AMC 431395	Red Bull-223	2015-2278				SEC19-T05S-R25E
AMC 431396	Red Bull-224	2015-2279				SEC19-T05S-R25E
AMC 431397	Red Bull-225	2015-2280				SEC19-T05S-R25E
AMC 431398	Red Bull-226	2015-2281				SEC19-T05S-R25E
AMC 431399	Red Bull-227	2015-2282				SEC19-T05S-R25E
AMC 431400	Red Bull-228	2015-2283				SEC19-T05S-R25E
AMC 431401	Red Bull-229	2015-2284				SEC19-T05S-R25E
AMC 431402	Red Bull-230	2015-2285				SEC19-T05S-R25E
AMC 431403	Red Bull-231	2015-2286				SEC19-T05S-R25E
AMC 431404	Red Bull-232	2015-2287				SEC19-T05S-R25E
AMC 431405	Red Bull-233	2015-2288				SEC19-T05S-R25E
AMC 431406	Red Bull-234	2015-2289				SEC19-T05S-R25E
AMC 431407	Red Bull-235	2015-2290				SEC19-T05S-R25E

Date: 6/1/2017

RECEIVED  
BLM AZ STATE OFFICE  
2017 JUL 12 A 10:45  
PHOENIX, ARIZONA

## Exhibit A

County: Graham

State: AZ

Original Recording

Amended Recording

<u>BLM Serial #</u>	<u>Claim Name</u>	<u>Recording #</u>	<u>Page #</u>	<u>Recording #</u>	<u>Page #</u>	<u>Location</u>
AMC 431408	Red Bull-236	2015-2291				SEC19-T05S-R25E
AMC 431409	Red Bull-237	2015-2292				SEC19-T05S-R25E
AMC 431410	Red Bull-238	2015-2293				SEC19-T05S-R25E
AMC 431411	Red Bull-239	2015-2294				SEC19-T05S-R25E
AMC 431412	Red Bull-240	2015-2295				SEC19-T05S-R25E
AMC 431413	Red Bull-241	2015-2296				SEC19-T05S-R25E
AMC 431414	Red Bull-242	2015-2297				SEC19-T05S-R25E
AMC 431415	Red Bull-243	2015-2298				SEC19-T05S-R25E
AMC 431416	Red Bull-244	2015-2299				SEC20-T05S-R25E
AMC 431417	Red Bull-245	2015-2300				SEC20-T05S-R25E
AMC 431418	Red Bull-246	2015-2301				SEC20-T05S-R25E
AMC 431419	Red Bull-247	2015-2302				SEC20-T05S-R25E
AMC 431420	Red Bull-248	2015-2303				SEC20-T05S-R25E
AMC 431421	Red Bull-249	2015-2304				SEC20-T05S-R25E
AMC 431422	Red Bull-250	2015-2305				SEC20-T05S-R25E
AMC 431423	Red Bull-251	2015-2306				SEC20-T05S-R25E
AMC 431424	Red Bull-252	2015-2307				SEC20-T05S-R25E
AMC 431425	Red Bull-253	2015-2308				SEC20-T05S-R25E
AMC 431426	Red Bull-254	2015-2309				SEC20-T05S-R25E
AMC 431427	Red Bull-255	2015-2310				SEC20-T05S-R25E
AMC 431428	Red Bull-256	2015-2311				SEC20-T05S-R25E
AMC 431429	Red Bull-257	2015-2312				SEC20-T05S-R25E
AMC 431430	Red Bull-258	2015-2313				SEC20-T05S-R25E
AMC 431431	Red Bull-259	2015-2314				SEC20-T05S-R25E
AMC 431432	Red Bull-260	2015-2315				SEC20-T05S-R25E
AMC 431433	Red Bull-261	2015-2316				SEC20-T05S-R25E
AMC 431434	Red Bull-262	2015-2317				SEC20-T05S-R25E
AMC 431435	Red Bull-263	2015-2318				SEC20-T05S-R25E
AMC 431436	Red Bull-264	2015-2319				SEC20-T05S-R25E
AMC 431437	Red Bull-265	2015-2320				SEC20-T05S-R25E
AMC 431438	Red Bull-266	2015-2321				SEC20-T05S-R25E
AMC 431439	Red Bull-267	2015-2322				SEC20-T05S-R25E
AMC 431440	Red Bull-268	2015-2323				SEC20-T05S-R25E
AMC 431441	Red Bull-269	2015-2324				SEC20-T05S-R25E
AMC 431442	Red Bull-270	2015-2325				SEC20-T05S-R25E
AMC 431443	Red Bull-271	2015-2326				SEC20-T05S-R25E
AMC 431444	Red Bull-272	2015-2327				SEC20-T05S-R25E
AMC 431445	Red Bull-273	2015-2328				SEC20-T05S-R25E

Date: 6/1/2017

RECEIVED  
 BLM AZ STATE OFFICE  
 2017 JUL 12 A 10:45  
 PHOENIX, ARIZO

## Exhibit A

County: Graham

State: AZ

BLM Serial #	Claim Name	Original Recording		Amended Recording		Location
		Recording #	Page #	Recording #	Page #	
AMC 431446	Red Bull-274	2015-2329				SEC20-T05S-R25E
AMC 431447	Red Bull-275	2015-2330				SEC20-T05S-R25E
AMC 431448	Red Bull-276	2015-2331				SEC20-T05S-R25E
AMC 431449	Red Bull-277	2015-2332				SEC20-T05S-R25E
AMC 431450	Red Bull-278	2015-2333				SEC20-T05S-R25E
AMC 431451	Red Bull-279	2015-2334				SEC20-T05S-R25E
AMC 431452	Red Bull-280	2015-2335				SEC21-T05S-R25E
AMC 431453	Red Bull-281	2015-2336				SEC21-T05S-R25E
AMC 431454	Red Bull-282	2015-2337				SEC21-T05S-R25E
AMC 431455	Red Bull-283	2015-2338				SEC21-T05S-R25E
AMC 431456	Red Bull-284	2015-2339				SEC21-T05S-R25E
AMC 431457	Red Bull-285	2015-2340				SEC21-T05S-R25E
AMC 431458	Red Bull-286	2015-2341				SEC21-T05S-R25E
AMC 431459	Red Bull-287	2015-2342				SEC21-T05S-R25E
AMC 431460	Red Bull-288	2015-2343				SEC21-T05S-R25E
AMC 431461	Red Bull-289	2015-2344				SEC21-T05S-R25E
AMC 431462	Red Bull-290	2015-2345				SEC21-T05S-R25E
AMC 431463	Red Bull-291	2015-2346				SEC21-T05S-R25E
AMC 431464	Red Bull-292	2015-2347				SEC21-T05S-R25E
AMC 431465	Red Bull-293	2015-2348				SEC21-T05S-R25E
AMC 431466	Red Bull-294	2015-2349				SEC21-T05S-R25E
AMC 431467	Red Bull-295	2015-2350				SEC21-T05S-R25E
AMC 431468	Red Bull-296	2015-2351				SEC21-T05S-R25E
AMC 431469	Red Bull-297	2015-2352				SEC21-T05S-R25E
AMC 431470	Red Bull-298	2015-2353				SEC21-T05S-R25E
AMC 431471	Red Bull-299	2015-2354				SEC21-T05S-R25E
AMC 431472	Red Bull-300	2015-2355				SEC21-T05S-R25E
AMC 431473	Red Bull-301	2015-2356				SEC21-T05S-R25E
AMC 431474	Red Bull-302	2015-2357				SEC21-T05S-R25E
AMC 431475	Red Bull-303	2015-2358				SEC21-T05S-R25E
AMC 431476	Red Bull-304	2015-2359				SEC21-T05S-R25E
AMC 431477	Red Bull-305	2015-2360				SEC21-T05S-R25E
AMC 431478	Red Bull-306	2015-2361				SEC21-T05S-R25E
AMC 431479	Red Bull-307	2015-2362				SEC21-T05S-R25E
AMC 431480	Red Bull-308	2015-2363				SEC21-T05S-R25E
AMC 431481	Red Bull-309	2015-2364				SEC21-T05S-R25E
AMC 431482	Red Bull-310	2015-2365				SEC21-T05S-R25E
AMC 431483	Red Bull-311	2015-2366				SEC21-T05S-R25E

Date: 6/1/2017

RECEIVED  
BLM AZ STATE OFFICE



## Exhibit A

County: Graham

State: AZ

<u>BLM Serial #</u>	<u>Claim Name</u>	<u>Original Recording</u>		<u>Amended Recording</u>		<u>Location</u>
		<u>Recording #</u>	<u>Page #</u>	<u>Recording #</u>	<u>Page #</u>	
AMC 431484	Red Bull-312	2015-2367				SEC21-T05S-R25E
AMC 431485	Red Bull-313	2015-2368				SEC21-T05S-R25E
AMC 431486	Red Bull-314	2015-2369				SEC21-T05S-R25E
AMC 431487	Red Bull-315	2015-2370				SEC21-T05S-R25E
AMC 431488	Red Bull-379	2015-2130				SEC14-T05S-R25E
AMC 431489	Red Bull-380	2015-2131				SEC14-T05S-R25E
AMC 431490	Red Bull-381	2015-2132				SEC14-T05S-R25E
AMC 431491	Red Bull-382	2015-2133				SEC14-T05S-R25E
AMC 431492	Red Bull-383	2015-2134				SEC14-T05S-R25E
AMC 431493	Red Bull-384	2015-2135				SEC14-T05S-R25E
AMC 431494	Red Bull-385	2015-2136				SEC14-T05S-R25E
AMC 431495	Red Bull-386	2015-2137				SEC14-T05S-R25E
AMC 431496	Red Bull-387	2015-2138				SEC14-T05S-R25E
AMC 431497	Red Bull-388	2015-2139				SEC14-T05S-R25E
AMC 431498	Red Bull-389	2015-2140				SEC14-T05S-R25E
AMC 431499	Red Bull-390	2015-2141				SEC14-T05S-R25E
AMC 431500	Red Bull-391	2015-2142				SEC14-T05S-R25E
AMC 431501	Red Bull-392	2015-2143				SEC14-T05S-R25E
AMC 431502	Red Bull-393	2015-2144				SEC14-T05S-R25E
AMC 431503	Red Bull-394	2015-2145				SEC14-T05S-R25E
AMC 431504	Red Bull-395	2015-2146				SEC14-T05S-R25E
AMC 431505	Red Bull-396	2015-2147				SEC14-T05S-R25E
AMC 431542	Red Bull-469	2015-2184				SEC23-T05S-R25E
AMC 431543	Red Bull-470	2015-2185				SEC23-T05S-R25E
AMC 431544	Red Bull-471	2015-2186				SEC23-T05S-R25E
AMC 431545	Red Bull-472	2015-2187				SEC23-T05S-R25E
AMC 431546	Red Bull-473	2015-2188				SEC23-T05S-R25E
AMC 431547	Red Bull-474	2015-2189				SEC23-T05S-R25E
AMC 431548	Red Bull-475	2015-2190				SEC23-T05S-R25E
AMC 431549	Red Bull-476	2015-2191				SEC23-T05S-R25E
AMC 431550	Red Bull-477	2015-2192				SEC23-T05S-R25E
AMC 431551	Red Bull-478	2015-2193				SEC23-T05S-R25E
AMC 431552	Red Bull-479	2015-2194				SEC23-T05S-R25E
AMC 431553	Red Bull-480	2015-2195				SEC23-T05S-R25E
AMC 431554	Red Bull-481	2015-2196				SEC23-T05S-R25E
AMC 431555	Red Bull-482	2015-2197				SEC23-T05S-R25E
AMC 431556	Red Bull-483	2015-2198				SEC23-T05S-R25E
AMC 431557	Red Bull-484	2015-2199				SEC23-T05S-R25E

Date: 6/1/2017

RECEIVED  
BLM AZ STATE OFFICE  
JUN 12 10 45 AM '17  
PHOENIX, ARIZO

## Exhibit A

County: Graham

State: AZ

BLM Serial #	Claim Name	Original Recording		Amended Recording		Location
		Recording #	Page #	Recording #	Page #	
AMC 431566	ROCKSTAR 173	2015-2450				SEC36-T06S-R27E
AMC 431567	ROCKSTAR 174	2015-2451				SEC36-T06S-R27E
AMC 431568	ROCKSTAR 175	2015-2452				SEC36-T06S-R27E
AMC 431569	ROCKSTAR 176	2015-2453				SEC36-T06S-R27E
AMC 431570	ROCKSTAR 177	2015-2454				SEC36-T06S-R27E
AMC 431571	ROCKSTAR 178	2015-2455				SEC36-T06S-R27E
AMC 431572	ROCKSTAR 179	2015-2456				SEC35-T06S-R27E
AMC 431573	ROCKSTAR 180	2015-2457				SEC35-T06S-R27E
AMC 431574	ROCKSTAR 181	2015-2458				SEC35-T06S-R27E
AMC 431575	ROCKSTAR 182	2015-2459				SEC35-T06S-R27E
AMC 431576	ROCKSTAR 183	2015-2460				SEC35-T06S-R27E
AMC 431577	ROCKSTAR 184	2015-2461				SEC35-T06S-R27E
AMC 431578	ROCKSTAR 185	2015-2462				SEC35-T06S-R27E
AMC 431579	ROCKSTAR 186	2015-2463				SEC35-T06S-R27E
AMC 431580	ROCKSTAR 187	2015-2464				SEC35-T06S-R27E
AMC 431581	ROCKSTAR 188	2015-2465				SEC35-T06S-R27E
AMC 431582	ROCKSTAR 189	2015-2466				SEC35-T06S-R27E
AMC 431583	ROCKSTAR 190	2015-2467				SEC35-T06S-R27E
AMC 431584	ROCKSTAR 191	2015-2468				SEC35-T06S-R27E
AMC 431585	ROCKSTAR 192	2015-2469				SEC35-T06S-R27E
AMC 431586	ROCKSTAR 193	2015-2470				SEC35-T06S-R27E
AMC 431587	ROCKSTAR 194	2015-2471				SEC35-T06S-R27E
AMC 431588	ROCKSTAR 195	2015-2472				SEC35-T06S-R27E
AMC 431589	ROCKSTAR 196	2015-2473				SEC35-T06S-R27E
AMC 431590	ROCKSTAR 197	2015-2474				SEC34-T06S-R27E
AMC 431591	ROCKSTAR 198	2015-2475				SEC34-T06S-R27E
AMC 431592	ROCKSTAR 199	2015-2476				SEC34-T06S-R27E
AMC 431593	ROCKSTAR 200	2015-2477				SEC34-T06S-R27E
AMC 431594	ROCKSTAR 201	2015-2478				SEC34-T06S-R27E
AMC 431595	ROCKSTAR 202	2015-2479				SEC34-T06S-R27E
AMC 431596	ROCKSTAR 203	2015-2480				SEC34-T06S-R27E
AMC 431597	ROCKSTAR 204	2015-2481				SEC34-T06S-R27E
AMC 431598	ROCKSTAR 205	2015-2482				SEC34-T06S-R27E
AMC 431599	ROCKSTAR 206	2015-2483				SEC34-T06S-R27E
AMC 431600	ROCKSTAR 207	2015-2484				SEC34-T06S-R27E
AMC 431601	ROCKSTAR 208	2015-2485				SEC34-T06S-R27E
AMC 431602	ROCKSTAR 209	2015-2486				SEC35-T06S-R27E
AMC 431603	ROCKSTAR 210	2015-2487				SEC27-T06S-R27E

Date: 6/1/2017

RECEIVED  
 BLM AZ STATE OFFICE  
 JUL 12 10:45 AM  
 PHOENIX, ARIZONA

## Exhibit A

County: Graham

State: AZ

Original Recording

Amended Recording

<u>BLM Serial #</u>	<u>Claim Name</u>	<u>Recording #</u>	<u>Page #</u>	<u>Recording #</u>	<u>Page #</u>	<u>Location</u>
AMC 431611	ROCKSTAR 211	2015-2591				SEC04-T07S-R27E
AMC 431612	ROCKSTAR 212	2015-2592				SEC04-T07S-R27E
AMC 431613	ROCKSTAR 213	2015-2593				SEC04-T07S-R27E
AMC 431614	ROCKSTAR 214	2015-2594				SEC04-T07S-R27E
AMC 431615	ROCKSTAR 215	2015-2595				SEC04-T07S-R27E
AMC 431616	ROCKSTAR 216	2015-2596				SEC04-T07S-R27E
AMC 431617	ROCKSTAR 217	2015-2597				SEC04-T07S-R27E
AMC 431618	ROCKSTAR 218	2015-2598				SEC04-T07S-R27E
AMC 431619	ROCKSTAR 219	2015-2599				SEC04-T07S-R27E
AMC 431620	ROCKSTAR 220	2015-2600				SEC04-T07S-R27E
AMC 431621	ROCKSTAR 221	2015-2601				SEC04-T07S-R27E
AMC 431622	ROCKSTAR 222	2015-2602				SEC04-T07S-R27E
AMC 431623	ROCKSTAR 223	2015-2603				SEC04-T07S-R27E
AMC 431624	ROCKSTAR 224	2015-2604				SEC04-T07S-R27E
AMC 431625	ROCKSTAR 225	2015-2605				SEC04-T07S-R27E
AMC 431626	ROCKSTAR 226	2015-2606				SEC04-T07S-R27E
AMC 431627	ROCKSTAR 227	2015-2607				SEC04-T07S-R27E
AMC 431628	ROCKSTAR 228	2015-2608				SEC04-T07S-R27E
AMC 431629	ROCKSTAR 229	2015-2609				SEC04-T07S-R27E
AMC 431630	ROCKSTAR 230	2015-2610				SEC04-T07S-R27E
AMC 431631	ROCKSTAR 231	2015-2611				SEC04-T07S-R27E
AMC 431632	ROCKSTAR 232	2015-2612				SEC04-T07S-R27E
AMC 431633	ROCKSTAR 233	2015-2613				SEC04-T07S-R27E
AMC 431634	ROCKSTAR 234	2015-2614				SEC04-T07S-R27E
AMC 431635	ROCKSTAR 235	2015-2615				SEC04-T07S-R27E
AMC 431636	ROCKSTAR 236	2015-2616				SEC04-T07S-R27E
AMC 431637	ROCKSTAR 237	2015-2617				SEC04-T07S-R27E
AMC 431638	ROCKSTAR 238	2015-2618				SEC04-T07S-R27E
AMC 431639	ROCKSTAR 239	2015-2619				SEC04-T07S-R27E
AMC 431640	ROCKSTAR 240	2015-2620				SEC04-T07S-R27E
AMC 431641	ROCKSTAR 241	2015-2621				SEC04-T07S-R27E
AMC 431642	ROCKSTAR 242	2015-2622				SEC04-T07S-R27E
AMC 431643	ROCKSTAR 243	2015-2623				SEC08-T07S-R27E
AMC 431644	ROCKSTAR 244	2015-2624				SEC08-T07S-R27E
AMC 431645	ROCKSTAR 245	2015-2625				SEC08-T07S-R27E
AMC 431646	ROCKSTAR 246	2015-2626				SEC08-T07S-R27E
AMC 431647	ROCKSTAR 247	2015-2627				SEC08-T07S-R27E
AMC 431648	ROCKSTAR 248	2015-2628				SEC08-T07S-R27E

Date: 6/1/2017

RECEIVED  
BLM AZ STATE OFFICE  
JUL 12 10:05 AM 2017  
PHOENIX, ARIZONA

## Exhibit A

County: Graham

State: AZ

<u>BLM Serial #</u>	<u>Claim Name</u>	<u>Original Recording</u>		<u>Amended Recording</u>		<u>Location</u>
		<u>Recording #</u>	<u>Page #</u>	<u>Recording #</u>	<u>Page #</u>	
AMC 431649 7	ROCKSTAR 249	2015-2629				SEC08-T07S-R27E
AMC 431650	ROCKSTAR 250	2015-2630				SEC08-T07S-R27E
AMC 431651	ROCKSTAR 251	2015-2631				SEC08-T07S-R27E
AMC 431652	ROCKSTAR 252	2015-2632				SEC08-T07S-R27E
AMC 431653	ROCKSTAR 253	2015-2633				SEC08-T07S-R27E
AMC 431654	ROCKSTAR 254	2015-2634				SEC08-T07S-R27E
AMC 431655	ROCKSTAR 255	2015-2635				SEC08-T07S-R27E
AMC 431656	ROCKSTAR 256	2015-2636				SEC08-T07S-R27E
AMC 431657	ROCKSTAR 257	2015-2637				SEC08-T07S-R27E
AMC 431658	ROCKSTAR 258	2015-2638				SEC08-T07S-R27E
AMC 431659	ROCKSTAR 259	2015-2639				SEC08-T07S-R27E
AMC 431660	ROCKSTAR 260	2015-2640				SEC08-T07S-R27E
AMC 431661	ROCKSTAR 261	2015-2641				SEC08-T07S-R27E
AMC 431662	ROCKSTAR 262	2015-2642				SEC08-T07S-R27E
AMC 431663	ROCKSTAR 263	2015-2643				SEC08-T07S-R27E
AMC 431664	ROCKSTAR 264	2015-2644				SEC08-T07S-R27E
AMC 431665	ROCKSTAR 265	2015-2645				SEC07-T07S-R27E
AMC 431666	ROCKSTAR 266	2015-2646				SEC07-T07S-R27E
AMC 431667	ROCKSTAR 267	2015-2647				SEC07-T07S-R27E
AMC 431668	ROCKSTAR 268	2015-2648				SEC07-T07S-R27E
AMC 431669	ROCKSTAR 269	2015-2649				SEC07-T07S-R27E
AMC 431671 7	ROCKSTAR 271	2015-2651				SEC07-T07S-R27E
AMC 431672	ROCKSTAR 272	2015-2652				SEC07-T07S-R27E
AMC 431673	ROCKSTAR 273	2015-2653				SEC07-T07S-R27E
AMC 431674	ROCKSTAR 274	2015-2654				SEC07-T07S-R27E
AMC 431675	ROCKSTAR 275	2015-2655				SEC07-T07S-R27E
AMC 431676	ROCKSTAR 276	2015-2656				SEC07-T07S-R27E
AMC 431677	ROCKSTAR 277	2015-2657				SEC07-T07S-R27E
AMC 431678	ROCKSTAR 278	2015-2658				SEC07-T07S-R27E
AMC 431679	ROCKSTAR 279	2015-2659				SEC07-T07S-R27E
AMC 431683	ROCKSTAR 283	2015-2663				SEC07-T07S-R27E
AMC 431791 7	MONSTER-224	2015-2808				SEC22-T05S-R27E
AMC 431792	MONSTER-225	2015-2809				SEC22-T05S-R27E
AMC 431793	MONSTER-226	2015-2810				SEC22-T05S-R27E
AMC 431794	MONSTER-227	2015-2811				SEC22-T05S-R27E
AMC 431795	MONSTER-228	2015-2812				SEC22-T05S-R27E
AMC 431796	MONSTER-229	2015-2813				SEC22-T05S-R27E
AMC 431797	MONSTER-230	2015-2814				SEC22-T05S-R27E

Date: 6/1/2017

RECEIVED  
BLM AZ STATE OFFICE  
JUN 12 10 45 AM 2017  
PHOENIX, ARIZONA

## Exhibit A

County: Graham

State: AZ

<u>BLM Serial #</u>	<u>Claim Name</u>	<u>Original Recording</u>		<u>Amended Recording</u>		<u>Location</u>
		<u>Recording #</u>	<u>Page #</u>	<u>Recording #</u>	<u>Page #</u>	
AMC 431798	MONSTER-231	2015-2815				SEC22-T05S-R27E
AMC 431799	MONSTER-232	2015-2816				SEC22-T05S-R27E
AMC 431800	MONSTER-233	2015-2817				SEC22-T05S-R27E
AMC 431801	MONSTER-234	2015-2818				SEC22-T05S-R27E
AMC 431802	MONSTER-235	2015-2819				SEC22-T05S-R27E
AMC 431803	MONSTER-236	2015-2820				SEC22-T05S-R27E
AMC 431804	MONSTER-237	2015-2821				SEC22-T05S-R27E
AMC 431805	MONSTER-238	2015-2822				SEC22-T05S-R27E
AMC 431806	MONSTER-239	2015-2823				SEC22-T05S-R27E
AMC 431807	MONSTER-240	2015-2824				SEC22-T05S-R27E
AMC 431808	MONSTER-241	2015-2825				SEC22-T05S-R27E
AMC 431809	MONSTER-242	2015-2826				SEC22-T05S-R27E
AMC 431810	MONSTER-243	2015-2827				SEC22-T05S-R27E
AMC 431811	MONSTER-244	2015-2828				SEC22-T05S-R27E
AMC 431812	MONSTER-245	2015-2829				SEC22-T05S-R27E
AMC 431813	MONSTER-246	2015-2830				SEC22-T05S-R27E
AMC 431814	MONSTER-247	2015-2831				SEC22-T05S-R27E
AMC 431815	MONSTER-248	2015-2832				SEC22-T05S-R27E
AMC 431816	MONSTER-249	2015-2833				SEC22-T05S-R27E
AMC 431817	MONSTER-250	2015-2834				SEC22-T05S-R27E
AMC 431818	MONSTER-251	2015-2835				SEC22-T05S-R27E
AMC 431819	MONSTER-252	2015-2836				SEC22-T05S-R27E
AMC 431820	MONSTER-253	2015-2837				SEC22-T05S-R27E
AMC 431821	MONSTER-254	2015-2838				SEC22-T05S-R27E
AMC 431822	MONSTER-255	2015-2839				SEC22-T05S-R27E
AMC 431823	MONSTER-256	2015-2840				SEC22-T05S-R27E
AMC 431824	MONSTER-257	2015-2841				SEC22-T05S-R27E
AMC 431825	MONSTER-258	2015-2842				SEC22-T05S-R27E
AMC 431826	MONSTER-259	2015-2843				SEC21-T05S-R27E
AMC 431827	MONSTER-260	2015-2844				SEC21-T05S-R27E
AMC 431828	MONSTER-261	2015-2845				SEC21-T05S-R27E
AMC 431829	MONSTER-262	2015-2846				SEC21-T05S-R27E
AMC 431830	MONSTER-263	2015-2847				SEC21-T05S-R27E
AMC 431831	MONSTER-264	2015-2848				SEC21-T05S-R27E
AMC 431832	MONSTER-265	2015-2849				SEC21-T05S-R27E
AMC 431833	MONSTER-266	2015-2850				SEC21-T05S-R27E
AMC 431834	MONSTER-267	2015-2851				SEC21-T05S-R27E
AMC 431835	MONSTER-268	2015-2852				SEC21-T05S-R27E

Date: 6/1/2017

RECEIVED  
 BLM AZ STATE OFFICE  
 JUN 12 2017 10:45  
 PHOENIX, ARIZONA

# Exhibit A

County: Graham

State: AZ

Original Recording

Amended Recording

<u>BLM Serial #</u>	<u>Claim Name</u>	<u>Recording #</u>	<u>Page #</u>	<u>Recording #</u>	<u>Page #</u>	<u>Location</u>
AMC 431836	MONSTER-269	2015-2853				SEC21-T05S-R27E
AMC 431837	MONSTER-270	2015-2854				SEC21-T05S-R27E
AMC 431838	MONSTER-271	2015-2855				SEC21-T05S-R27E
AMC 431839	MONSTER-272	2015-2856				SEC21-T05S-R27E
AMC 431840	MONSTER-277	2015-2857				SEC21-T05S-R27E
AMC 431841	MONSTER-278	2015-2858				SEC21-T05S-R27E
AMC 431842	MONSTER-279	2015-2859				SEC21-T05S-R27E
AMC 431843	MONSTER-280	2015-2860				SEC21-T05S-R27E
AMC 431844	MONSTER-285	2015-2861				SEC21-T05S-R27E
AMC 431845	MONSTER-286	2015-2862				SEC21-T05S-R27E
AMC 431846	MONSTER-287	2015-2863				SEC21-T05S-R27E
AMC 431847	MONSTER-288	2015-2864				SEC21-T05S-R27E
AMC 431848	MONSTER-293	2015-2865				SEC21-T05S-R27E
AMC 431849	MONSTER-294	2015-2866				SEC21-T05S-R27E
AMC 431850	MONSTER-421	2015-2867				SEC16-T05S-R27E
AMC 431851	MONSTER-422	2015-2868				SEC16-T05S-R27E
AMC 431852	MONSTER-423	2015-2869				SEC16-T05S-R27E
AMC 431853	MONSTER-424	2015-2870				SEC16-T05S-R27E
AMC 431854	MONSTER-425	2015-2871				SEC16-T05S-R27E
AMC 431855	MONSTER-426	2015-2872				SEC16-T05S-R27E
AMC 431856	MONSTER-427	2015-2873				SEC16-T05S-R27E
AMC 431857	MONSTER-428	2015-2874				SEC16-T05S-R27E
AMC 431858	MONSTER-429	2015-2875				SEC16-T05S-R27E
AMC 431859	MONSTER-430	2015-2876				SEC16-T05S-R27E
AMC 431860	MONSTER-431	2015-2877				SEC16-T05S-R27E
AMC 431861	MONSTER-432	2015-2878				SEC16-T05S-R27E
AMC 431862	MONSTER-433	2015-2879				SEC16-T05S-R27E
AMC 431863	MONSTER-434	2015-2880				SEC16-T05S-R27E
AMC 431864	MONSTER-435	2015-2881				SEC16-T05S-R27E
AMC 431865	MONSTER-436	2015-2882				SEC16-T05S-R27E
AMC 431866	MONSTER-437	2015-2883				SEC16-T05S-R27E
AMC 431867	MONSTER-438	2015-2884				SEC16-T05S-R27E
AMC 431868	MONSTER-439	2015-2885				SEC16-T05S-R27E
AMC 431869	MONSTER-440	2015-2886				SEC16-T05S-R27E
AMC 431870	MONSTER-441	2015-2887				SEC16-T05S-R27E
AMC 431871	MONSTER-442	2015-2888				SEC16-T05S-R27E
AMC 431872	MONSTER-443	2015-2889				SEC16-T05S-R27E
AMC 431873	MONSTER-444	2015-2890				SEC16-T05S-R27E

Date: 6/1/2017

RECEIVED  
BLM AZ STATE OFFICE  
JUL 12 2017  
PHOENIX, ARIZONA

# Exhibit A

County: Graham

State: AZ

Original Recording

Amended Recording

<u>BLM Serial #</u>	<u>Claim Name</u>	<u>Recording #</u>	<u>Page #</u>	<u>Recording #</u>	<u>Page #</u>	<u>Location</u>
AMC 431874	MONSTER-445	2015-2891				SEC16-T05S-R27E
AMC 431875	MONSTER-446	2015-2892				SEC16-T05S-R27E
AMC 431876	MONSTER-447	2015-2893				SEC16-T05S-R27E
AMC 431877	MONSTER-448	2015-2894				SEC16-T05S-R25E
AMC 431878	MONSTER-449	2015-2895				SEC15-T05S-R27E
AMC 431879	MONSTER-450	2015-2896				SEC15-T05S-R27E
AMC 431880	MONSTER-451	2015-2897				SEC15-T05S-R27E
AMC 431881	MONSTER-452	2015-2898				SEC15-T05S-R27E
AMC 431882	MONSTER-453	2015-2899				SEC15-T05S-R27E
AMC 431883	MONSTER-454	2015-2900				SEC15-T05S-R27E
AMC 431884	MONSTER-455	2015-2901				SEC15-T05S-R27E
AMC 431885	MONSTER-456	2015-2902				SEC15-T05S-R27E
AMC 431886	MONSTER-457	2015-2903				SEC15-T05S-R27E
AMC 431887	MONSTER-458	2015-2904				SEC15-T05S-R27E
AMC 431888	MONSTER-459	2015-2905				SEC15-T05S-R27E
AMC 431889	MONSTER-460	2015-2906				SEC15-T05S-R27E
AMC 431890	MONSTER-461	2015-2907				SEC15-T05S-R27E
AMC 431891	MONSTER-462	2015-2908				SEC15-T05S-R27E
AMC 431892	MONSTER-463	2015-2909				SEC15-T05S-R27E
AMC 431893	MONSTER-464	2015-2910				SEC15-T05S-R27E
AMC 431894	MONSTER-465	2015-2911				SEC15-T05S-R27E
AMC 431895	MONSTER-466	2015-2912				SEC15-T05S-R27E
AMC 431896	MONSTER-467	2015-2913				SEC15-T05S-R27E
AMC 431897	MONSTER-468	2015-2914				SEC15-T05S-R27E
AMC 431898	MONSTER-469	2015-2915				SEC15-T05S-R27E
AMC 431899	MONSTER-470	2015-2916				SEC15-T05S-R27E
AMC 431900	MONSTER-471	2015-2917				SEC15-T05S-R27E
AMC 431901	MONSTER-472	2015-2918				SEC15-T05S-R27E
AMC 431902	MONSTER-473	2015-2919				SEC15-T05S-R27E
AMC 431903	MONSTER-474	2015-2920				SEC15-T05S-R27E
AMC 431904	MONSTER-109	2015-2664				SEC27-T05S-R27E
AMC 431905	MONSTER-110	2015-2665				SEC27-T05S-R27E
AMC 431906	MONSTER-111	2015-2666				SEC27-T05S-R27E
AMC 431907	MONSTER-112	2015-2667				SEC27-T05S-R27E
AMC 431908	MONSTER-113	2015-2668				SEC27-T05S-R27E
AMC 431909	MONSTER-114	2015-2669				SEC27-T05S-R27E
AMC 431910	MONSTER-115	2015-2670				SEC27-T05S-R27E
AMC 431911	MONSTER-116	2015-2671				SEC27-T05S-R27E

Date: 6/1/2017

RECEIVED  
BLM AZ STATE OFFICE  
2017 JUL 12 A 10:45  
PHOENIX, ARIZONA

## Exhibit A

County: Graham

State: AZ

<u>BLM Serial #</u>	<u>Claim Name</u>	<u>Original Recording</u>		<u>Amended Recording</u>		<u>Location</u>
		<u>Recording #</u>	<u>Page #</u>	<u>Recording #</u>	<u>Page #</u>	
AMC 431912	MONSTER-117	2015-2672				SEC27-T05S-R27E
AMC 431913	MONSTER-118	2015-2673				SEC27-T05S-R27E
AMC 431914	MONSTER-119	2015-2674				SEC27-T05S-R27E
AMC 431915	MONSTER-120	2015-2675				SEC27-T05S-R27E
AMC 431916	MONSTER-121	2015-2676				SEC27-T05S-R27E
AMC 431917	MONSTER-122	2015-2677				SEC27-T05S-R27E
AMC 431918	MONSTER-123	2015-2678				SEC27-T05S-R27E
AMC 431919	MONSTER-124	2015-2679				SEC27-T05S-R27E
AMC 431920	MONSTER-125	2015-2680				SEC27-T05S-R27E
AMC 431921	MONSTER-126	2015-2681				SEC27-T05S-R27E
AMC 431922	MONSTER-127	2015-2682				SEC27-T05S-R27E
AMC 431923	MONSTER-128	2015-2683				SEC27-T05S-R27E
AMC 431924	MONSTER-129	2015-2684				SEC27-T05S-R27E
AMC 431925	MONSTER-130	2015-2685				SEC27-T05S-R27E
AMC 431926	MONSTER-131	2015-2686				SEC27-T05S-R27E
AMC 431927	MONSTER-132	2015-2687				SEC27-T05S-R27E
AMC 431928	MONSTER-133	2015-2688				SEC27-T05S-R27E
AMC 431929	MONSTER-134	2015-2689				SEC27-T05S-R27E
AMC 431930	MONSTER-135	2015-2690				SEC27-T05S-R27E
AMC 431931	MONSTER-136	2015-2691				SEC27-T05S-R27E
AMC 431932	MONSTER-137	2015-2692				SEC27-T05S-R27E
AMC 431933	MONSTER-138	2015-2693				SEC27-T05S-R27E
AMC 431934	MONSTER-139	2015-2694				SEC27-T05S-R27E
AMC 431935	MONSTER-140	2015-2695				SEC27-T05S-R27E
AMC 431936	MONSTER-141	2015-2696				SEC34-T05S-R27E
AMC 431937	MONSTER-142	2015-2697				SEC34-T05S-R27E
AMC 431938	MONSTER-143	2015-2698				SEC34-T05S-R27E
AMC 431939	MONSTER-144	2015-2699				SEC34-T05S-R27E
AMC 431940	MONSTER-145	2015-2700				SEC34-T05S-R27E
AMC 431941	MONSTER-146	2015-2701				SEC34-T05S-R27E
AMC 431942	MONSTER-147	2015-2702		2016-04041		SEC34-T05S-R27E
AMC 431943	MONSTER-148	2015-2703		2016-04042		SEC34-T05S-R27E
AMC 431944	MONSTER-151	2015-2704		2016-04043		SEC34-T05S-R27E
AMC 431945	MONSTER-152	2015-2705		2016-04044		SEC34-T05S-R27E
AMC 431946	MONSTER-153	2015-2706				SEC34-T05S-R27E
AMC 431947	MONSTER-154	2015-2707				SEC34-T05S-R27E
AMC 431948	MONSTER-155	2015-2708				SEC34-T05S-R27E
AMC 431949	MONSTER-156	2015-2709				SEC34-T05S-R27E

Date: 6/1/2017

RECEIVED  
BLM AZ STATE OFFICE  
JUL 12 10:45 AM  
PHOENIX, ARIZONA



## Exhibit A

County: Graham

State: AZ

<u>BLM Serial #</u>	<u>Claim Name</u>	<u>Original Recording</u>		<u>Amended Recording</u>		<u>Location</u>
		<u>Recording #</u>	<u>Page #</u>	<u>Recording #</u>	<u>Page #</u>	
AMC 431950	MONSTER-157	2015-2710				SEC34-T05S-R27E
AMC 431951	MONSTER-158	2015-2711				SEC34-T05S-R27E
AMC 431952	MONSTER-177	2015-2712				SEC35-T05S-R27E
AMC 431953	MONSTER-178	2015-2713				SEC35-T05S-R27E
AMC 431954	MONSTER-179	2015-2714				SEC35-T05S-R27E
AMC 431955	MONSTER-180	2015-2715				SEC35-T05S-R27E
AMC 431956	MONSTER-181	2015-2716				SEC35-T05S-R27E
AMC 431957	MONSTER-182	2015-2717				SEC35-T05S-R27E
AMC 431958	MONSTER-183	2015-2718				SEC35-T05S-R27E
AMC 431959	MONSTER-184	2015-2719				SEC35-T05S-R27E
AMC 431960	MONSTER-185	2015-2720				SEC35-T05S-R27E
AMC 431961	MONSTER-186	2015-2721				SEC35-T05S-R27E
AMC 431962	MONSTER-187	2015-2722				SEC35-T05S-R27E
AMC 431963	MONSTER-188	2015-2723				SEC35-T05S-R27E
AMC 431964	MONSTER-189	2015-2724				SEC35-T05S-R27E
AMC 431965	MONSTER-190	2015-2725				SEC35-T05S-R27E
AMC 431966	MONSTER-191	2015-2726				SEC35-T05S-R27E
AMC 431967	MONSTER-192	2015-2727				SEC35-T05S-R27E
AMC 431968	MONSTER-193	2015-2728				SEC35-T05S-R27E
AMC 431969	MONSTER-194	2015-2729				SEC35-T05S-R27E
AMC 431970	MONSTER-195	2015-2730				SEC35-T05S-R27E
AMC 431971	MONSTER-196	2015-2731				SEC35-T05S-R27E
AMC 431972	MONSTER-197	2015-2732				SEC35-T05S-R27E
AMC 431973	MONSTER-198	2015-2733				SEC35-T05S-R27E
AMC 431974	MONSTER-199	2015-2734				SEC35-T05S-R27E
AMC 431975	MONSTER-200	2015-2735				SEC35-T05S-R27E
AMC 431976	MONSTER-201	2015-2736				SEC35-T05S-R27E
AMC 431977	MONSTER-202	2015-2737				SEC26-T05S-R27E
AMC 431978	MONSTER-203	2015-2738				SEC26-T05S-R27E
AMC 431979	MONSTER-204	2015-2739				SEC26-T05S-R27E
AMC 431980	MONSTER-205	2015-2740				SEC26-T05S-R27E
AMC 431981	MONSTER-206	2015-2741				SEC26-T05S-R27E
AMC 431982	MONSTER-207	2015-2742				SEC26-T05S-R27E
AMC 431983	MONSTER-208	2015-2743				SEC26-T05S-R27E
AMC 431984	MONSTER-209	2015-2744				SEC26-T05S-R27E
AMC 431985	MONSTER-210	2015-2745				SEC26-T05S-R27E
AMC 431986	MONSTER-211	2015-2746				SEC26-T05S-R27E
AMC 431987	MONSTER-212	2015-2747				SEC26-T05S-R27E

Date: 6/1/2017

RECEIVED  
BLM AZ STATE OFFICE  
2017 JUL 12 A 10:46  
PHOENIX, ARIZONA

## Exhibit A

County: Graham

State: AZ

<u>BLM Serial #</u>	<u>Claim Name</u>	<u>Original Recording</u>		<u>Amended Recording</u>		<u>Location</u>
		<u>Recording #</u>	<u>Page #</u>	<u>Recording #</u>	<u>Page #</u>	
AMC 431988	MONSTER-213	2015-2748				SEC26-T05S-R27E
AMC 431989	MONSTER-214	2015-2749				SEC26-T05S-R27E
AMC 431990	MONSTER-215	2015-2750				SEC26-T05S-R27E
AMC 431991	MONSTER-216	2015-2751				SEC26-T05S-R27E
AMC 431992	MONSTER-217	2015-2752				SEC26-T05S-R27E
AMC 431993	MONSTER-218	2015-2753				SEC26-T05S-R27E
AMC 431994	MONSTER-219	2015-2754				SEC23-T05S-R27E
AMC 431995	MONSTER-220	2015-2755				SEC23-T05S-R27E
AMC 431996	MONSTER-221	2015-2756				SEC23-T05S-R27E
AMC 431997	MONSTER-222	2015-2757				SEC23-T05S-R27E
AMC 431998	MONSTER-223	2015-2758				SEC23-T05S-R27E
AMC 431999	MONSTER-273	2015-2759				SEC21-T05S-R27E
AMC 432000	MONSTER-274	2015-2760				SEC21-T05S-R27E
AMC 432001	MONSTER-275	2015-2761				SEC21-T05S-R27E
AMC 432002	MONSTER-276	2015-2762				SEC21-T05S-R27E
AMC 432003	MONSTER-281	2015-2763				SEC21-T05S-R27E
AMC 432004	MONSTER-282	2015-2764				SEC21-T05S-R27E
AMC 432005	MONSTER-283	2015-2765				SEC21-T05S-R27E
AMC 432006	MONSTER-284	2015-2766				SEC21-T05S-R27E
AMC 432007	MONSTER-289	2015-2767				SEC21-T05S-R27E
AMC 432008	MONSTER-290	2015-2768				SEC21-T05S-R27E
AMC 432009	MONSTER-291	2015-2769				SEC21-T05S-R27E
AMC 432010	MONSTER-292	2015-2770				SEC21-T05S-R27E
AMC 432011	MONSTER-295	2015-2771				SEC20-T05S-R27E
AMC 432012	MONSTER-296	2015-2772				SEC20-T05S-R27E
AMC 432013	MONSTER-297	2015-2773				SEC20-T05S-R27E
AMC 432014	MONSTER-298	2015-2774				SEC20-T05S-R27E
AMC 432015	MONSTER-299	2015-2775				SEC20-T05S-R27E
AMC 432016	MONSTER-300	2015-2776				SEC20-T05S-R27E
AMC 432017	MONSTER-301	2015-2777				SEC20-T05S-R27E
AMC 432018	MONSTER-302	2015-2778				SEC20-T05S-R27E
AMC 432019	MONSTER-303	2015-2779				SEC20-T05S-R27E
AMC 432020	MONSTER-304	2015-2780				SEC20-T05S-R27E
AMC 432021	MONSTER-305	2015-2781				SEC20-T05S-R27E
AMC 432022	MONSTER-306	2015-2782				SEC20-T05S-R27E
AMC 432023	MONSTER-307	2015-2783				SEC20-T05S-R27E
AMC 432024	MONSTER-308	2015-2784				SEC20-T05S-R27E
AMC 432025	MONSTER-309	2015-2785				SEC20-T05S-R27E

Date: 6/1/2017

RECEIVED  
BLM AZ STATE OFFICE  
JUL 12 A 10:46  
PHOENIX, ARIZONA

## Exhibit A

County: Graham

State: AZ

BLM Serial #	Claim Name	Original Recording		Amended Recording		Location
		Recording #	Page #	Recording #	Page #	
AMC 432026	MONSTER-310	2015-2786				SEC20-T05S-R27E
AMC 432027	MONSTER-311	2015-2787				SEC20-T05S-R27E
AMC 432028	MONSTER-312	2015-2789				SEC20-T05S-R27E
AMC 432029	MONSTER-313	2015-2790				SEC20-T05S-R27E
AMC 432030	MONSTER-314	2015-2791				SEC20-T05S-R27E
AMC 432031	MONSTER-315	2015-2792				SEC20-T05S-R27E
AMC 432032	MONSTER-316	2015-2793				SEC20-T05S-R27E
AMC 432033	MONSTER-317	2015-2794				SEC20-T05S-R27E
AMC 432034	MONSTER-318	2015-2795				SEC20-T05S-R27E
AMC 432035	MONSTER-319	2015-2796				SEC20-T05S-R27E
AMC 432036	MONSTER-320	2015-2797				SEC20-T05S-R27E
AMC 432037	MONSTER-321	2015-2798				SEC20-T05S-R27E
AMC 432038	MONSTER-322	2015-2799				SEC20-T05S-R27E
AMC 432039	MONSTER-323	2015-2800				SEC20-T05S-R27E
AMC 432040	MONSTER-324	2015-2801				SEC20-T05S-R27E
AMC 432041	MONSTER-325	2015-2802				SEC20-T05S-R27E
AMC 432042	MONSTER-326	2015-2803				SEC20-T05S-R27E
AMC 432043	MONSTER-327	2015-2804				SEC20-T05S-R27E
AMC 432044	MONSTER-328	2015-2805				SEC20-T05S-R27E
AMC 432045	MONSTER-329	2015-2806				SEC20-T05S-R27E
AMC 432046	MONSTER-330	2015-2807				SEC20-T05S-R27E
AMC 432120	Red Bull-361	2015-3021				SEC14-T05S-R25E
AMC 432121	Red Bull-362	2015-3022				SEC14-T05S-R25E
AMC 432122	Red Bull-363	2015-3023				SEC14-T05S-R25E
AMC 432123	Red Bull-364	2015-3024				SEC14-T05S-R25E
AMC 432124	Red Bull-365	2015-3025				SEC14-T05S-R25E
AMC 432125	Red Bull-366	2015-3026				SEC14-T05S-R25E
AMC 432126	Red Bull-367	2015-3027				SEC14-T05S-R25E
AMC 432127	Red Bull-368	2015-3028				SEC14-T05S-R25E
AMC 432128	Red Bull-369	2015-3029				SEC14-T05S-R25E
AMC 432129	Red Bull-370	2015-3030				SEC14-T05S-R25E
AMC 432130	Red Bull-371	2015-3031				SEC14-T05S-R25E
AMC 432131	Red Bull-372	2015-3032				SEC14-T05S-R25E
AMC 432132	Red Bull-373	2015-3033				SEC14-T05S-R25E
AMC 432133	Red Bull-374	2015-3034				SEC14-T05S-R25E
AMC 432134	Red Bull-375	2015-3035				SEC14-T05S-R25E
AMC 432135	Red Bull-376	2015-3036				SEC14-T06S-R25E
AMC 432136	Red Bull-377	2015-3037				SEC14-T05S-R25E

Date: 6/1/2017

RECEIVED  
 BLM AZ STATE OFFICE  
 2017 JUL 12 A 10:46  
 PHOENIX, ARIZONA

## Exhibit A

County: Graham

State: AZ

BLM Serial #	Claim Name	Original Recording		Amended Recording		Location
		Recording #	Page #	Recording #	Page #	
AMC 432137	Red Bull-378	2015-3038				SEC14-T05S-R25E
AMC 432174	Red Bull-485	2015-3075				SEC25-T05S-R26E
AMC 432175	Red Bull-486	2015-3076				SEC25-T05S-R26E
AMC 432176	Red Bull-487	2015-3077				SEC25-T05S-R26E
AMC 432177	Red Bull-488	2015-3078				SEC25-T05S-R26E
AMC 432178	Red Bull-489	2015-3079				SEC25-T05S-R26E
AMC 432179	Red Bull-490	2015-3080				SEC25-T05S-R26E
AMC 432180	Red Bull-491	2015-3081				SEC25-T05S-R26E
AMC 432181	Red Bull-492	2015-3082				SEC25-T05S-R26E
AMC 432182	Red Bull-530	2015-3083				SEC13-T05S-R26E
AMC 432183	Red Bull-531	2015-3084				SEC13-T05S-R26E
AMC 432184	Red Bull-533	2015-3085				SEC13-T05S-R26E
AMC 432185	Red Bull-534	2015-3086				SEC13-T05S-R26E
AMC 432186	Red Bull-536	2015-3087				SEC13-T05S-R26E
AMC 432187	Red Bull-537	2015-3088				SEC13-T05S-R26E
AMC 432188	Red Bull-539	2015-3089				SEC13-T05S-R26E
AMC 432189	Red Bull-540	2015-3090				SEC13-T05S-R26E
AMC 432190	Red Bull-542	2015-3091				SEC13-T05S-R26E
AMC 432191	Red Bull-543	2015-3092				SEC13-T05S-R26E
AMC 432192	Red Bull-545	2015-3093				SEC13-T05S-R26E
AMC 432193	Red Bull-546	2015-3094				SEC13-T05S-R26E
AMC 432194	Red Bull-548	2015-3095				SEC13-T05S-R26E
AMC 432195	Red Bull-549	2015-3096				SEC13-T05S-R26E
AMC 432196	Red Bull-551	2015-3097				SEC13-T05S-R26E
AMC 432197	Red Bull-552	2015-3098				SEC13-T05S-R26E
AMC 432198	Red Bull-554	2015-3099				SEC13-T05S-R26E
AMC 432199	Red Bull-555	2015-3100				SEC12-T05S-R26E
AMC 432200	Red Bull-556	2015-3101				SEC12-T05S-R26E
AMC 432201	Red Bull-557	2015-3102				SEC12-T05S-R26E
AMC 432202	Red Bull-558	2015-3103				SEC12-T05S-R26E
AMC 432203	Red Bull-559	2015-3104				SEC12-T05S-R26E
AMC 432204	Red Bull-560	2015-3105				SEC12-T05S-R26E
AMC 432205	Red Bull-561	2015-3106				SEC12-T05S-R26E
AMC 432206	Red Bull-562	2015-3107				SEC12-T05S-R26E
AMC 432207	Red Bull-563	2015-3108				SEC12-T05S-R26E
AMC 432208	Red Bull-564	2015-3109				SEC12-T05S-R26E
AMC 432209	Red Bull-565	2015-3110				SEC12-T05S-R26E
AMC 432210	Red Bull-566	2015-3111				SEC12-T05S-R26E

Date: 6/1/2017

RECEIVED  
BLM AZ STATE OFFICE  
2017 JUL 12 A 10:48  
PHOENIX, ARIZONA

## Exhibit A

County: Graham

State: AZ

BLM Serial #	Claim Name	Original Recording		Amended Recording		Location
		Recording #	Page #	Recording #	Page #	
AMC 432211	Red Bull-567	2015-3112				SEC12-T05S-R26E
AMC 432212	Red Bull-568	2015-3113				SEC12-T05S-R26E
AMC 432213	Red Bull-569	2015-3114				SEC12-T05S-R26E
AMC 432214	Red Bull-570	2015-3115				SEC12-T05S-R26E
AMC 432215	Red Bull-571	2015-3116				SEC12-T05S-R26E
AMC 432216	Red Bull-572	2015-3117				SEC12-T05S-R26E
AMC 432217	Red Bull-573	2015-3118				SEC12-T05S-R26E
AMC 432218	Red Bull-574	2015-3119				SEC12-T05S-R26E
AMC 432219	Red Bull-575	2015-3120				SEC12-T05S-R26E
AMC 432220	Red Bull-576	2015-3121				SEC12-T05S-R26E
AMC 432221	Red Bull-577	2015-3122				SEC12-T05S-R26E
AMC 432222	Red Bull-578	2015-3123				SEC12-T05S-R26E
AMC 432223	Red Bull-579	2015-3124				SEC12-T05S-R26E
AMC 432224	Red Bull-580	2015-3125				SEC12-T05S-R26E
AMC 432225	Red Bull-581	2015-3126				SEC12-T05S-R26E
AMC 432226	Red Bull-582	2015-3127				SEC12-T05S-R26E
AMC 432227	Red Bull-583	2015-3128				SEC12-T05S-R26E
AMC 432228	Red Bull-584	2015-3129				SEC12-T05S-R26E
AMC 432229	Red Bull-585	2015-3130				SEC12-T05S-R26E
AMC 432230	Red Bull-586	2015-3131				SEC12-T05S-R26E
AMC 432231	Red Bull-587	2015-3132				SEC12-T05S-R26E
AMC 432232	Red Bull-588	2015-3133				SEC12-T05S-R26E
AMC 432233	Red Bull-589	2015-3134				SEC12-T05S-R26E
AMC 432234	Red Bull-590	2015-3135				SEC12-T05S-R26E
AMC 432235	Red Bull-591	2015-3136				SEC12-T05S-R26E
AMC 432241	MONSTER-367	2015-3138				SEC18-T05S-R27E
AMC 432242	MONSTER-368	2015-3139				SEC18-T05S-R27E
AMC 432243	MONSTER-369	2015-3140				SEC18-T05S-R27E
AMC 432244	MONSTER-370	2015-3141				SEC18-T05S-R27E
AMC 432245	MONSTER-371	2015-3142				SEC18-T05S-R27E
AMC 432246	MONSTER-372	2015-3143				SEC18-T05S-R27E
AMC 432247	MONSTER-373	2015-3144				SEC18-T05S-R27E
AMC 432248	MONSTER-374	2015-3145				SEC18-T05S-R27E
AMC 432249	MONSTER-375	2015-3146				SEC18-T05S-R27E
AMC 432250	MONSTER-376	2015-3147				SEC18-T05S-R27E
AMC 432251	MONSTER-377	2015-3148				SEC18-T05S-R27E
AMC 432252	MONSTER-378	2015-3149				SEC18-T05S-R27E
AMC 432253	MONSTER-379	2015-3150				SEC18-T05S-R27E

Date: 6/1/2017

RECEIVED  
BLM AZ STATE OFFICE  
2017 JUL 12 A 10:46  
PHOENIX, ARIZONA

## Exhibit A

County: Graham

State: AZ

<u>BLM Serial #</u>	<u>Claim Name</u>	<u>Original Recording</u>		<u>Amended Recording</u>		<u>Location</u>
		<u>Recording #</u>	<u>Page #</u>	<u>Recording #</u>	<u>Page #</u>	
AMC 432254	MONSTER-380	2015-3151				SEC18-T05S-R27E
AMC 432255	MONSTER-381	2015-3152				SEC18-T05S-R27E
AMC 432256	MONSTER-382	2015-3153				SEC18-T05S-R27E
AMC 432257	MONSTER-383	2015-3154				SEC18-T05S-R27E
AMC 432258	MONSTER-384	2015-3155				SEC18-T05S-R27E
AMC 432259	MONSTER-385	2015-3156				SEC18-T05S-R27E
AMC 432260	MONSTER-386	2015-3157				SEC18-T05S-R27E
AMC 432261	MONSTER-387	2015-3158				SEC18-T05S-R27E
AMC 432262	MONSTER-388	2015-3159				SEC18-T05S-R27E
AMC 432263	MONSTER-389	2015-3160				SEC18-T05S-R27E
AMC 432264	MONSTER-390	2015-3161				SEC18-T05S-R27E
AMC 432265	MONSTER-391	2015-3162				SEC18-T05S-R27E
AMC 432266	MONSTER-392	2015-3163				SEC18-T05S-R27E
AMC 432267	MONSTER-393	2015-3164				SEC18-T05S-R27E
AMC 432268	MONSTER-394	2015-3165				SEC17-T05S-R27E
AMC 432269	MONSTER-395	2015-3166				SEC17-T05S-R27E
AMC 432270	MONSTER-396	2015-3167				SEC17-T05S-R27E
AMC 432271	MONSTER-397	2015-3168				SEC17-T05S-R27E
AMC 432272	MONSTER-398	2015-3169				SEC17-T05S-R27E
AMC 432273	MONSTER-399	2015-3170				SEC17-T05S-R27E
AMC 432274	MONSTER-400	2015-3171				SEC17-T05S-R27E
AMC 432275	MONSTER-401	2015-3172				SEC17-T05S-R27E
AMC 432276	MONSTER-402	2015-3173				SEC17-T05S-R27E
AMC 432277	MONSTER-403	2015-3174				SEC17-T05S-R27E
AMC 432278	MONSTER-404	2015-3175				SEC17-T05S-R27E
AMC 432279	MONSTER-405	2015-3176				SEC17-T05S-R27E
AMC 432280	MONSTER-406	2015-3177				SEC17-T05S-R27E
AMC 432281	MONSTER-407	2015-3178				SEC17-T05S-R27E
AMC 432282	MONSTER-408	2015-3179				SEC17-T05S-R27E
AMC 432283	MONSTER-409	2015-3180				SEC17-T05S-R27E
AMC 432284	MONSTER-410	2015-3181				SEC17-T05S-R27E
AMC 432285	MONSTER-411	2015-3182				SEC17-T05S-R27E
AMC 432286	MONSTER-412	2015-3183				SEC17-T05S-R27E
AMC 432287	MONSTER-413	2015-3184				SEC17-T05S-R27E
AMC 432288	MONSTER-414	2015-3185				SEC17-T05S-R27E
AMC 432289	MONSTER-415	2015-3186				SEC17-T05S-R27E
AMC 432290	MONSTER-416	2015-3187				SEC17-T05S-R27E
AMC 432291	MONSTER-417	2015-3188				SEC17-T05S-R27E

Date: 6/1/2017

RECEIVED  
BLM AZ STATE OFFICE  
2017 JUL 12 A 10:48  
PHOENIX, ARIZONA

## Exhibit A

County: Graham

State: AZ

Original Recording

Amended Recording

<u>BLM Serial #</u>	<u>Claim Name</u>	<u>Recording #</u>	<u>Page #</u>	<u>Recording #</u>	<u>Page #</u>	<u>Location</u>
AMC 432292	MONSTER-418	2015-3189				SEC17-T05S-R27E
AMC 432293	MONSTER-419	2015-3190				SEC17-T05S-R27E
AMC 432294	MONSTER-420	2015-3191				SEC17-T05S-R27E
AMC 432295	MONSTER-475	2015-3182				SEC10-T05S-R27E
AMC 432296	MONSTER-476	2015-3183				SEC10-T05S-R27E
AMC 432297	MONSTER-477	2015-3184				SEC10-T05S-R27E
AMC 432298	MONSTER-478	2015-3185				SEC10-T05S-R27E
AMC 432299	MONSTER-479	2015-3186				SEC10-T05S-R27E
AMC 432300	MONSTER-480	2015-3187				SEC10-T05S-R27E
AMC 432301	MONSTER-481	2015-3188				SEC10-T05S-R27E
AMC 432302	MONSTER-482	2015-3189				SEC10-T05S-R27E
AMC 432303	MONSTER-483	2015-3190				SEC09-T05S-R27E
AMC 432304	MONSTER-484	2015-3191				SEC09-T05S-R27E
AMC 432305	MONSTER-485	2015-3192				SEC09-T05S-R27E
AMC 432306	MONSTER-486	2015-3193				SEC09-T05S-R27E
AMC 432307	MONSTER-487	2015-3194				SEC09-T05S-R27E
AMC 432308	MONSTER-488	2015-3195				SEC09-T05S-R27E
AMC 432309	MONSTER-489	2015-3196				SEC09-T05S-R27E
AMC 432310	MONSTER-490	2015-3197				SEC09-T05S-R27E
AMC 432311	MONSTER-491	2015-3198				SEC09-T05S-R27E
AMC 432312	MONSTER-492	2015-3199				SEC09-T05S-R27E
AMC 432313	MONSTER-493	2015-3200				SEC09-T05S-R27E
AMC 432314	MONSTER-494	2015-3201				SEC09-T05S-R27E
AMC 432315	MONSTER-495	2015-3202				SEC09-T05S-R27E
AMC 432316	MONSTER-496	2015-3203				SEC09-T05S-R27E
AMC 432317	MONSTER-497	2015-3204				SEC09-T05S-R27E
AMC 432318	MONSTER-498	2015-3205				SEC09-T05S-R27E
AMC 432319	MONSTER-499	2015-3206				SEC09-T05S-R27E
AMC 432320	MONSTER-500	2015-3207				SEC09-T05S-R27E
AMC 432321	MONSTER-501	2015-3208				SEC09-T05S-R27E
AMC 432322	MONSTER-502	2015-3209				SEC09-T05S-R27E
AMC 432323	MONSTER-503	2015-3210				SEC09-T05S-R27E
AMC 432324	MONSTER-504	2015-3211				SEC09-T05S-R27E
AMC 432325	MONSTER-505	2015-3212				SEC09-T05S-R27E
AMC 432326	MONSTER-506	2015-3213				SEC09-T05S-R27E
AMC 432327	MONSTER-507	2015-3214				SEC09-T05S-R27E
AMC 432328	MONSTER-508	2015-3215				SEC09-T05S-R27E
AMC 432329	MONSTER-509	2015-3216				SEC09-T05S-R27E

Date: 6/1/2017

RECEIVED  
 BLM AZ STATE OFFICE  
 2017 JUL 12 A 10:48  
 PHOENIX, ARIZONA

## Exhibit A

County: Graham

State: AZ

<u>BLM Serial #</u>	<u>Claim Name</u>	<u>Original Recording</u>		<u>Amended Recording</u>		<u>Location</u>
		<u>Recording #</u>	<u>Page #</u>	<u>Recording #</u>	<u>Page #</u>	
AMC 432330	MONSTER-510	2015-3217				SEC08-T05S-R27E
AMC 432331	MONSTER-511	2015-3218				SEC08-T05S-R27E
AMC 432332	MONSTER-512	2015-3219				SEC08-T05S-R27E
AMC 432333	MONSTER-513	2015-3220				SEC08-T05S-R27E
AMC 432334	MONSTER-514	2015-3221				SEC08-T05S-R27E
AMC 432335	MONSTER-515	2015-3222				SEC08-T05S-R27E
AMC 432336	MONSTER-516	2015-3223				SEC08-T05S-R27E
AMC 432337	MONSTER-517	2015-3224				SEC08-T05S-R27E
AMC 432338	MONSTER-518	2015-3225				SEC08-T05S-R27E
AMC 432339	MONSTER-519	2015-3226				SEC08-T05S-R27E
AMC 432340	MONSTER-520	2015-3227				SEC08-T05S-R27E
AMC 432341	MONSTER-521	2015-3228				SEC08-T05S-R27E
AMC 432342	MONSTER-522	2015-3229				SEC08-T05S-R27E
AMC 432343	MONSTER-523	2015-3230				SEC08-T05S-R27E
AMC 432344	MONSTER-524	2015-3231				SEC08-T05S-R27E
AMC 432345	MONSTER-525	2015-3232				SEC08-T05S-R27E
AMC 432346	MONSTER-526	2015-3233				SEC08-T05S-R27E
AMC 432347	MONSTER-527	2015-3234				SEC08-T05S-R27E
AMC 432348	MONSTER-528	2015-3235				SEC08-T05S-R27E
AMC 432349	MONSTER-529	2015-3236				SEC08-T05S-R27E
AMC 432350	MONSTER-530	2015-3237				SEC08-T05S-R27E
AMC 432351	MONSTER-531	2015-3238				SEC08-T05S-R27E
AMC 432352	MONSTER-532	2015-3239				SEC08-T05S-R27E
AMC 432353	MONSTER-533	2015-3240				SEC08-T05S-R27E
AMC 432354	MONSTER-534	2015-3241				SEC08-T05S-R27E
AMC 432355	MONSTER-535	2015-3242				SEC08-T05S-R27E
AMC 432356	MONSTER-536	2015-3243				SEC08-T05S-R27E
AMC 432357	MONSTER-537	2015-3244				SEC07-T05S-R27E
AMC 432358	MONSTER-538	2015-3245				SEC07-T05S-R27E
AMC 432359	MONSTER-539	2015-3246				SEC07-T05S-R27E
AMC 432360	MONSTER-540	2015-3247				SEC07-T05S-R27E
AMC 432361	MONSTER-541	2015-3248				SEC07-T05S-R27E
AMC 432362	MONSTER-542	2015-3249				SEC07-T05S-R27E
AMC 432363	MONSTER-543	2015-3250				SEC07-T05S-R27E
AMC 432364	MONSTER-544	2015-3251				SEC07-T05S-R27E
AMC 432365	MONSTER-545	2015-3252				SEC07-T05S-R27E
AMC 432366	MONSTER-546	2015-3253				SEC07-T05S-R27E
AMC 432367	MONSTER-547	2015-3254				SEC07-T05S-R27E

Date: 6/1/2017

RECEIVED  
BLM AZ STATE OFFICE  
2017 JUL 12 A 10:18  
PHOENIX, ARIZONA



## Exhibit A

County: Graham

State: AZ

BLM Serial #	Claim Name	Original Recording		Amended Recording		Location
		Recording #	Page #	Recording #	Page #	
AMC 432368	MONSTER-548	2015-3255				SEC07-T05S-R27E
AMC 432369	MONSTER-549	2015-3256				SEC07-T05S-R27E
AMC 432370	MONSTER-550	2015-3257				SEC07-T05S-R27E
AMC 432371	MONSTER-551	2015-3258				SEC07-T05S-R27E
AMC 432372	MONSTER-552	2015-3259				SEC07-T05S-R27E
AMC 432373	MONSTER-553	2015-3260				SEC07-T05S-R27E
AMC 432374	MONSTER-554	2015-3261				SEC07-T05S-R27E
AMC 432375	MONSTER-555	2015-3262				SEC07-T05S-R27E
AMC 432376	MONSTER-556	2015-3263				SEC07-T05S-R27E
AMC 432377	MONSTER-557	2015-3264				SEC07-T05S-R27E
AMC 432378	MONSTER-558	2015-3265				SEC07-T05S-R27E
AMC 432379	MONSTER-559	2015-3266				SEC07-T05S-R27E
AMC 432380	MONSTER-560	2015-3267				SEC07-T05S-R27E
AMC 432381	MONSTER-561	2015-3268				SEC07-T05S-R27E
AMC 432382	MONSTER-562	2015-3269				SEC07-T05S-R27E
AMC 432383	MONSTER-563	2015-3270				SEC07-T05S-R27E
AMC 432384	MONSTER-589	2015-3281				SEC08-T05S-R27E
AMC 432385	MONSTER-590	2015-3282				SEC05-T05S-R27E
AMC 432386	MONSTER-591	2015-3283				SEC04-T05S-R27E
AMC 432387	MONSTER-592	2015-3284				SEC04-T05S-R27E
AMC 432388	MONSTER-593	2015-3285				SEC04-T05S-R27E
AMC 432389	MONSTER-594	2015-3286				SEC04-T05S-R27E
AMC 432390	MONSTER-595	2015-3287				SEC04-T05S-R27E
AMC 432391	MONSTER-596	2015-3288				SEC04-T05S-R27E
AMC 432392	MONSTER-597	2015-3289				SEC04-T05S-R27E
AMC 432393	MONSTER-598	2015-3290				SEC04-T05S-R27E
AMC 432394	MONSTER-599	2015-3291				SEC04-T05S-R27E
AMC 432395	MONSTER-600	2015-3292				SEC04-T05S-R27E
AMC 432396	MONSTER-601	2015-3293				SEC04-T05S-R27E
AMC 432397	MONSTER-602	2015-3294				SEC04-T05S-R27E
AMC 432398	MONSTER-603	2015-3295				SEC04-T05S-R27E
AMC 432399	MONSTER-604	2015-3296				SEC04-T05S-R27E
AMC 432400	MONSTER-605	2015-3297				SEC04-T05S-R27E
AMC 432401	MONSTER-606	2015-3298				SEC04-T05S-R27E
AMC 432402	MONSTER-607	2015-3299				SEC04-T05S-R27E
AMC 432403	MONSTER-608	2015-3300				SEC04-T05S-R27E
AMC 432404	MONSTER-609	2015-3301				SEC04-T05S-R27E
AMC 432405	MONSTER-610	2015-3302				SEC04-T05S-R27E

Date: 6/1/2017

RECEIVED  
BLM AZ STATE OFFICE  
JUL 12 10:18 AM 2017  
PHOENIX, ARIZONA

## Exhibit A

County: Graham

State: AZ

<u>BLM Serial #</u>	<u>Claim Name</u>	<u>Original Recording</u>		<u>Amended Recording</u>		<u>Location</u>
		<u>Recording #</u>	<u>Page #</u>	<u>Recording #</u>	<u>Page #</u>	
AMC 432406	MONSTER-611	2015-3303				SEC04-T05S-R27E
AMC 432407	MONSTER-612	2015-3304				SEC04-T05S-R27E
AMC 432408	MONSTER-613	2015-3305				SEC04-T05S-R27E
AMC 432409	MONSTER-614	2015-3306				SEC04-T05S-R27E
AMC 432410	MONSTER-615	2015-3307				SEC04-T05S-R27E
AMC 432411	MONSTER-616	2015-3308				SEC04-T05S-R27E
AMC 432412	MONSTER-617	2015-3309				SEC04-T05S-R27E
AMC 432413	MONSTER-618	2015-3310				SEC04-T05S-R27E
AMC 432414	MONSTER-619	2015-3311				SEC04-T05S-R27E
AMC 432415	MONSTER-620	2015-3312				SEC04-T05S-R27E
AMC 432416	MONSTER-621	2015-3313				SEC04-T05S-R27E
AMC 432417	MONSTER-622	2015-3314				SEC04-T05S-R27E
AMC 432443	MONSTER-564	2015-3476				SEC06-T05S-R27E
AMC 432444	MONSTER-565	2015-3477				SEC06-T05S-R27E
AMC 432445	MONSTER-566	2015-3478				SEC06-T05S-R27E
AMC 432446	MONSTER-567	2015-3479				SEC06-T05S-R27E
AMC 432447	MONSTER-568	2015-3480				SEC06-T05S-R27E
AMC 432448	MONSTER-569	2015-3481				SEC06-T05S-R27E
AMC 432449	MONSTER-570	2015-3482				SEC06-T05S-R27E
AMC 432450	MONSTER-571	2015-3483				SEC06-T05S-R27E
AMC 432451	MONSTER-572	2015-3484				SEC06-T05S-R27E
AMC 432452	MONSTER-573	2015-3485				SEC06-T05S-R27E
AMC 432453	MONSTER-574	2015-3486				SEC06-T05S-R27E
AMC 432454	MONSTER-575	2015-3487				SEC06-T05S-R27E
AMC 432455	MONSTER-576	2015-3488				SEC06-T05S-R27E
AMC 432456	MONSTER-577	2015-3489				SEC06-T05S-R27E
AMC 432457	MONSTER-578	2015-3490				SEC06-T05S-R27E
AMC 432458	MONSTER-579	2015-3491				SEC06-T05S-R27E
AMC 432459	MONSTER-580	2015-3492				SEC06-T05S-R27E
AMC 432460	MONSTER-581	2015-3493				SEC06-T05S-R27E
AMC 432461	MONSTER-582	2015-3494				SEC06-T05S-R27E
AMC 432462	MONSTER-583	2015-3495				SEC06-T05S-R27E
AMC 432463	MONSTER-584	2015-3496				SEC05-T05S-R27E
AMC 432464	MONSTER-585	2015-3497				SEC05-T05S-R27E
AMC 432465	MONSTER-586	2015-3498				SEC08-T05S-R27E
AMC 432466	MONSTER-587	2015-3499				SEC08-T05S-R27E
AMC 432467	MONSTER-588	2015-3500				SEC08-T05S-R27E
AMC 432486	Red Bull-493	2015-3656				SEC24-T05S-R26E

Date: 6/1/2017

RECEIVED  
BLM AZ STATE OFFICE  
2017 JUL 12 A 10:48  
PHOENIX, ARIZONA

## Exhibit A

County: Graham

State: AZ

<u>BLM Serial #</u>	<u>Claim Name</u>	<u>Original Recording</u>		<u>Amended Recording</u>		<u>Location</u>
		<u>Recording #</u>	<u>Page #</u>	<u>Recording #</u>	<u>Page #</u>	
AMC 432487	Red Bull-494	2015-3657				SEC24-T05S-R26E
AMC 432488	Red Bull-495	2015-3658				SEC24-T05S-R26E
AMC 432489	Red Bull-496	2015-3659				SEC24-T05S-R26E
AMC 432490	Red Bull-497	2015-3660				SEC24-T05S-R26E
AMC 432491	Red Bull-498	2015-3661				SEC24-T05S-R26E
AMC 432492	Red Bull-499	2015-3662				SEC24-T05S-R26E
AMC 432493	Red Bull-500	2015-3663				SEC24-T05S-R26E
AMC 432494	Red Bull-501	2015-3664				SEC24-T05S-R26E
AMC 432495	Red Bull-502	2015-3665				SEC24-T05S-R26E
AMC 432496	Red Bull-503	2015-3666				SEC24-T05S-R26E
AMC 432497	Red Bull-504	2015-3667				SEC24-T05S-R26E
AMC 432498	Red Bull-505	2015-3668				SEC24-T05S-R26E
AMC 432499	Red Bull-506	2015-3669				SEC24-T05S-R26E
AMC 432500	Red Bull-507	2015-3670				SEC24-T05S-R26E
AMC 432501	Red Bull-508	2015-3671				SEC24-T05S-R26E
AMC 432502	Red Bull-509	2015-3672				SEC24-T05S-R26E
AMC 432503	Red Bull-510	2015-3673				SEC24-T05S-R26E
AMC 432504	Red Bull-511	2015-3674				SEC24-T05S-R26E
AMC 432505	Red Bull-512	2015-3675				SEC24-T05S-R26E
AMC 432506	Red Bull-513	2015-3676				SEC24-T05S-R26E
AMC 432507	Red Bull-514	2015-3677				SEC24-T05S-R26E
AMC 432508	Red Bull-515	2015-3678				SEC24-T05S-R26E
AMC 432509	Red Bull-516	2015-3679				SEC24-T05S-R26E
AMC 432510	Red Bull-517	2015-3680				SEC24-T05S-R26E
AMC 432511	Red Bull-518	2015-3681				SEC24-T05S-R26E
AMC 432512	Red Bull-519	2015-3682				SEC24-T05S-R26E
AMC 432513	Red Bull-520	2015-3683				SEC24-T05S-R26E
AMC 432514	Red Bull-521	2015-3684				SEC24-T05S-R26E
AMC 432515	Red Bull-522	2015-3685				SEC24-T05S-R26E
AMC 432516	Red Bull-523	2015-3686				SEC24-T05S-R26E
AMC 432517	Red Bull-524	2015-3687				SEC24-T05S-R26E
AMC 432518	Red Bull-525	2015-3688				SEC24-T05S-R26E
AMC 432519	Red Bull-526	2015-3689				SEC24-T05S-R26E
AMC 432520	Red Bull-527	2015-3690				SEC24-T05S-R26E
AMC 432521	Red Bull-528	2015-3691				SEC24-T05S-R26E
AMC 432522	Red Bull-529	2015-3692				SEC13-T05S-R26E
AMC 432523	Red Bull-532	2015-3693				SEC13-T05S-R26E
AMC 432524	Red Bull-535	2015-3694				SEC13-T05S-R26E

Date: 6/1/2017

RECEIVED  
BLM AZ STATE OFFICE  
2017 JUL 12 A 10:48  
PHOENIX, ARIZONA

## Exhibit A

County: Graham

State: AZ

<u>BLM Serial #</u>	<u>Claim Name</u>	<u>Original Recording</u>		<u>Amended Recording</u>		<u>Location</u>
		<u>Recording #</u>	<u>Page #</u>	<u>Recording #</u>	<u>Page #</u>	
AMC 432525	Red Bull-538	2015-3695				SEC13-T05S-R26E
AMC 432526	Red Bull-541	2015-3696				SEC13-T05S-R26E
AMC 432527	Red Bull-544	2015-3697				SEC13-T05S-R26E
AMC 432528	Red Bull-547	2015-3698				SEC13-T05S-R26E
AMC 432529	Red Bull-550	2015-3699				SEC13-T05S-R26E
AMC 432530	Red Bull-553	2015-3700				SEC13-T05S-R26E
AMC 432531	Red Bull-592	2015-3701				SEC01-T05S-R26E
AMC 432532	Red Bull-593	2015-3702				SEC01-T05S-R26E
AMC 432533	Red Bull-594	2015-3703				SEC01-T05S-R26E
AMC 432534	Red Bull-595	2015-3704				SEC01-T05S-R26E
AMC 432535	Red Bull-596	2015-3705				SEC01-T05S-R26E
AMC 432536	Red Bull-597	2015-3706				SEC01-T05S-R26E
AMC 432537	Red Bull-598	2015-3707				SEC01-T05S-R26E
AMC 432538	Red Bull-599	2015-3708				SEC01-T05S-R26E
AMC 432539	Red Bull-600	2015-3709				SEC01-T05S-R26E
AMC 432540	Red Bull-601	2015-3710				SEC01-T05S-R26E
AMC 432541	Red Bull-602	2015-3711				SEC01-T05S-R26E
AMC 432542	Red Bull-603	2015-3712				SEC01-T05S-R26E
AMC 432543	Red Bull-604	2015-3713				SEC01-T05S-R26E
AMC 432544	Red Bull-605	2015-3714				SEC23-T05S-R26E
AMC 432545	Red Bull-606	2015-3715				SEC23-T05S-R26E
AMC 432546	Red Bull-607	2015-3716				SEC23-T05S-R26E
AMC 432547	Red Bull-608	2015-3717				SEC23-T05S-R26E
AMC 432548	Red Bull-609	2015-3718				SEC23-T05S-R26E
AMC 432549	Red Bull-610	2015-3719				SEC23-T05S-R26E
AMC 432550	Red Bull-611	2015-3720				SEC23-T05S-R26E
AMC 432551	Red Bull-612	2015-3721				SEC23-T05S-R25E
AMC 432552	Red Bull-613	2015-3722				SEC14-T05S-R26E
AMC 432553	Red Bull-614	2015-3723				SEC14-T05S-R26E
AMC 432554	Red Bull-615	2015-3724				SEC14-T05S-R26E
AMC 432555	Red Bull-616	2015-3725				SEC14-T05S-R26E
AMC 432556	Red Bull-617	2015-3726				SEC14-T05S-R26E
AMC 432557	Red Bull-618	2015-3727				SEC14-T05S-R26E
AMC 432558	Red Bull-619	2015-3728				SEC14-T05S-R26E
AMC 432559	Red Bull-620	2015-3729				SEC14-T05S-R26E
AMC 432560	Red Bull-621	2015-3730				SEC14-T05S-R26E
AMC 432561	Red Bull-622	2015-3731				SEC14-T05S-R26E
AMC 432562	Red Bull-623	2015-3732				SEC14-T05S-R26E

Date: 6/1/2017

RECEIVED  
BLM AZ STATE OFFICE  
JUL 12 10:48 AM 2017  
PHOENIX, ARIZONA

## Exhibit A

County: Graham

State: AZ

Original Recording

Amended Recording

<u>BLM Serial #</u>	<u>Claim Name</u>	<u>Recording #</u>	<u>Page #</u>	<u>Recording #</u>	<u>Page #</u>	<u>Location</u>
AMC 432563	Red Bull-624	2015-3733				SEC14-T05S-R26E
AMC 432564	Red Bull-625	2015-3734				SEC14-T05S-R26E
AMC 432565	Red Bull-626	2015-3735				SEC14-T05S-R26E
AMC 432566	Red Bull-627	2015-3736				SEC14-T05S-R26E
AMC 432567	Red Bull-628	2015-3737				SEC14-T05S-R26E
AMC 432568	Red Bull-629	2015-3738				SEC14-T05S-R26E
AMC 432569	Red Bull-630	2015-3739				SEC14-T05S-R26E
AMC 432570	Red Bull-631	2015-3740				SEC14-T05S-R26E
AMC 432571	Red Bull-632	2015-3741				SEC14-T05S-R26E
AMC 432572	Red Bull-633	2015-3742				SEC14-T05S-R26E
AMC 432573	Red Bull-634	2015-3743				SEC14-T05S-R26E
AMC 432574	Red Bull-635	2015-3744				SEC14-T05S-R26E
AMC 432575	Red Bull-636	2015-3745				SEC14-T05S-R26E
AMC 432576	Red Bull-637	2015-3746				SEC14-T05S-R26E
AMC 432577	Red Bull-638	2015-3747				SEC14-T05S-R26E
AMC 432578	Red Bull-639	2015-3748				SEC14-T05S-R26E
AMC 432579	Red Bull-640	2015-3749				SEC14-T05S-R26E
AMC 432580	Red Bull-641	2015-3750				SEC11-T05S-R26E
AMC 432581	Red Bull-642	2015-3751				SEC11-T05S-R26E
AMC 432582	Red Bull-643	2015-3752				SEC11-T05S-R26E
AMC 432583	Red Bull-644	2015-3753				SEC11-T05S-R26E
AMC 432584	Red Bull-645	2015-3754				SEC11-T05S-R26E
AMC 432585	Red Bull-646	2015-3755				SEC11-T05S-R26E
AMC 432586	Red Bull-647	2015-3756				SEC11-T05S-R26E
AMC 432587	Red Bull-648	2015-3757				SEC11-T05S-R26E
AMC 432588	Red Bull-649	2015-3758				SEC11-T05S-R26E
AMC 432589	Red Bull-650	2015-3759				SEC11-T05S-R26E
AMC 432590	Red Bull-651	2015-3760				SEC11-T05S-R26E
AMC 432591	Red Bull-652	2015-3761				SEC11-T05S-R26E
AMC 432592	Red Bull-653	2015-3762				SEC11-T05S-R26E
AMC 432593	Red Bull-654	2015-3763				SEC11-T05S-R26E
AMC 432594	Red Bull-655	2015-3764				SEC11-T05S-R26E
AMC 432595	Red Bull-656	2015-3765				SEC11-T05S-R26E
AMC 432596	Red Bull-657	2015-3766				SEC11-T05S-R26E
AMC 432597	Red Bull-658	2015-3767				SEC11-T05S-R26E
AMC 432598	Red Bull-659	2015-3768				SEC11-T05S-R26E
AMC 432599	Red Bull-660	2015-3769				SEC11-T05S-R26E
AMC 432600	Red Bull-661	2015-3770				SEC11-T05S-R26E

Date: 6/1/2017

RECEIVED  
BLM AZ STATE OFFICE  
2017 JUL 12 A 10:12  
PHOENIX, ARIZONA

## Exhibit A

County: Graham

State: AZ

<u>BLM Serial #</u>	<u>Claim Name</u>	<u>Original Recording</u>		<u>Amended Recording</u>		<u>Location</u>
		<u>Recording #</u>	<u>Page #</u>	<u>Recording #</u>	<u>Page #</u>	
AMC 432601	Red Bull-662	2015-3771				SEC11-T05S-R26E
AMC 432602	Red Bull-663	2015-3772				SEC11-T05S-R26E
AMC 432603	Red Bull-664	2015-3773				SEC11-T05S-R26E
AMC 432604	Red Bull-665	2015-3774				SEC11-T05S-R26E
AMC 432605	Red Bull-666	2015-3775				SEC11-T05S-R26E
AMC 432606	Red Bull-667	2015-3776				SEC11-T05S-R26E
AMC 432607	Red Bull-668	2015-3777				SEC11-T05S-R26E
AMC 432608	Red Bull-669	2015-3778				SEC11-T05S-R26E
AMC 432609	Red Bull-670	2015-3779				SEC11-T05S-R26E
AMC 432610	Red Bull-671	2015-3780				SEC11-T05S-R26E
AMC 432611	Red Bull-672	2015-3781				SEC11-T05S-R26E
AMC 432612	Red Bull-673	2015-3782				SEC11-T05S-R26E
AMC 432613	Red Bull-674	2015-3783				SEC11-T05S-R26E
AMC 432614	Red Bull-675	2015-3784				SEC11-T05S-R26E
AMC 432615	Red Bull-676	2015-3785				SEC11-T05S-R26E
AMC 432616	Red Bull-677	2015-3786				SEC11-T05S-R26E
AMC 432617	Red Bull-678	2015-3787				SEC11-T05S-R26E
AMC 432618	Red Bull-679	2015-3788				SEC11-T05S-R26E
AMC 432619	Red Bull-680	2015-3789				SEC11-T05S-R26E
AMC 432621	ROCKSTAR 284	2015-3867				SEC06-T06S-R27E
AMC 432622	ROCKSTAR 285	2015-3868				SEC06-T06S-R25E
AMC 432623	ROCKSTAR 286	2015-3869				SEC06-T06S-R25E
AMC 432624	ROCKSTAR 287	2015-3870				SEC06-T06S-R25E
AMC 432625	ROCKSTAR 288	2015-3871				SEC06-T06S-R25E
AMC 432626	ROCKSTAR 289	2015-3872				SEC06-T06S-R25E
AMC 432627	ROCKSTAR 290	2015-3873				SEC06-T06S-R25E
AMC 432628	ROCKSTAR 291	2015-3874				SEC06-T06S-R25E
AMC 432629	ROCKSTAR 292	2015-3875				SEC06-T06S-R25E
AMC 432630	ROCKSTAR 293	2015-3876				SEC06-T06S-R25E
AMC 432631	ROCKSTAR 294	2015-3877				SEC06-T06S-R25E
AMC 432632	ROCKSTAR 295	2015-3878				SEC06-T06S-R25E
AMC 432633	ROCKSTAR 296	2015-3879				SEC06-T06S-R25E
AMC 432634	ROCKSTAR 297	2015-3880				SEC06-T06S-R25E
AMC 432635	ROCKSTAR 298	2015-3881				SEC06-T06S-R25E
AMC 432636	ROCKSTAR 299	2015-3882				SEC06-T06S-R25E
AMC 432637	ROCKSTAR 300	2015-3883				SEC06-T06S-R25E
AMC 432638	ROCKSTAR 301	2015-3884				SEC06-T06S-R25E
AMC 432639	ROCKSTAR 302	2015-3885				SEC06-T06S-R25E

Date: 6/1/2017

RECEIVED  
 BLM AZ STATE OFFICE  
 2017 JUL 12 A 10:58  
 PHOTO SECTION

## Exhibit A

County: Graham

State: AZ

Original Recording

Amended Recording

<u>BLM Serial #</u>	<u>Claim Name</u>	<u>Recording #</u>	<u>Page #</u>	<u>Recording #</u>	<u>Page #</u>	<u>Location</u>
AMC 432640	ROCKSTAR 303	2015-3886				SEC06-T06S-R25E
AMC 432641	ROCKSTAR 304	2015-3887				SEC06-T06S-R25E
AMC 432642	ROCKSTAR 305	2015-3888				SEC06-T06S-R25E
AMC 432643	ROCKSTAR 306	2015-3889				SEC06-T06S-R25E
AMC 432644	ROCKSTAR 307	2015-3890				SEC06-T06S-R25E
AMC 432645	ROCKSTAR 308	2015-3891				SEC06-T06S-R25E
AMC 432646	ROCKSTAR 309	2015-3892				SEC06-T06S-R25E
AMC 432647	ROCKSTAR 310	2015-3893				SEC06-T06S-R25E
AMC 432648	ROCKSTAR 311	2015-3894				SEC06-T06S-R25E
AMC 432649	ROCKSTAR 312	2015-3895				SEC06-T06S-R25E
AMC 432650	ROCKSTAR 313	2015-3896				SEC06-T06S-R25E
AMC 432651	ROCKSTAR 314	2015-3897				SEC05-T06S-R25E
AMC 432652	ROCKSTAR 315	2015-3898				SEC05-T06S-R25E
AMC 432653	ROCKSTAR 316	2015-3899				SEC05-T06S-R25E
AMC 432654	ROCKSTAR 317	2015-3900				SEC05-T06S-R25E
AMC 432655	ROCKSTAR 318	2015-3901				SEC05-T06S-R25E
AMC 432656	ROCKSTAR 319	2015-3902				SEC05-T06S-R25E
AMC 432657	ROCKSTAR 320	2015-3903				SEC05-T06S-R25E
AMC 432658	ROCKSTAR 321	2015-3904				SEC05-T06S-R25E
AMC 432659	ROCKSTAR 322	2015-3905				SEC05-T06S-R25E
AMC 432660	ROCKSTAR 323	2015-3906				SEC05-T06S-R25E
AMC 432661	ROCKSTAR 324	2015-3907				SEC05-T06S-R25E
AMC 432662	ROCKSTAR 325	2015-3908				SEC05-T06S-R25E
AMC 432663	ROCKSTAR 326	2015-3909				SEC05-T06S-R25E
AMC 432664	ROCKSTAR 327	2015-3910				SEC05-T06S-R25E
AMC 432665	ROCKSTAR 328	2015-3911				SEC05-T06S-R25E
AMC 432666	ROCKSTAR 329	2015-3912				SEC05-T06S-R25E
AMC 432667	ROCKSTAR 330	2015-3913				SEC05-T06S-R25E
AMC 432668	ROCKSTAR 331	2015-3914				SEC05-T06S-R25E
AMC 432669	ROCKSTAR 332	2015-3915				SEC05-T06S-R25E
AMC 432670	ROCKSTAR 333	2015-3916				SEC05-T06S-R25E
AMC 432671	ROCKSTAR 334	2015-3917				SEC05-T06S-R25E
AMC 432672	ROCKSTAR 335	2015-3918				SEC05-T06S-R25E
AMC 432673	ROCKSTAR 336	2015-3919				SEC05-T06S-R25E
AMC 432674	ROCKSTAR 337	2015-3920				SEC05-T06S-R25E
AMC 432675	ROCKSTAR 338	2015-3921				SEC05-T06S-R25E
AMC 432676	ROCKSTAR 339	2015-3922				SEC05-T06S-R25E
AMC 432677	ROCKSTAR 340	2015-3923				SEC05-T06S-R25E

Date: 6/1/2017

RECEIVED  
BLM AZ STATE OFFICE  
2017 JUL 12 A 10:48  
PHOENIX ARIZONA

## Exhibit A

County: Graham

State: AZ

<u>BLM Serial #</u>	<u>Claim Name</u>	<u>Original Recording</u>		<u>Amended Recording</u>		<u>Location</u>
		<u>Recording #</u>	<u>Page #</u>	<u>Recording #</u>	<u>Page #</u>	
AMC 432678	ROCKSTAR 341	2015-3924				SEC05-T06S-R25E
AMC 432679	ROCKSTAR 342	2015-3925				SEC05-T06S-R25E
AMC 432680	ROCKSTAR 343	2015-3926				SEC05-T06S-R25E
AMC 432681	ROCKSTAR 344	2015-3927				SEC05-T06S-R25E
AMC 432682	ROCKSTAR 345	2015-3928				SEC05-T06S-R25E
AMC 432683	ROCKSTAR 346	2015-3929				SEC05-T06S-R25E
AMC 432684	ROCKSTAR 347	2015-3930				SEC05-T06S-R25E
AMC 432685	ROCKSTAR 348	2015-3931				SEC05-T06S-R25E
AMC 432686	ROCKSTAR 349	2015-3932				SEC05-T06S-R25E
AMC 432687	ROCKSTAR 350	2015-3933				SEC04-T06S-R25E
AMC 432688	ROCKSTAR 351	2015-3934				SEC04-T06S-R25E
AMC 432689	ROCKSTAR 352	2015-3935				SEC04-T06S-R25E
AMC 432690	ROCKSTAR 353	2015-3936				SEC04-T06S-R25E
AMC 432691	ROCKSTAR 354	2015-3937				SEC04-T06S-R25E
AMC 432692	ROCKSTAR 355	2015-3938				SEC04-T06S-R25E
AMC 432693	ROCKSTAR 356	2015-3939				SEC04-T06S-R25E
AMC 432694	ROCKSTAR 357	2015-3940				SEC04-T06S-R25E
AMC 432695	ROCKSTAR 358	2015-3941				SEC04-T06S-R25E
AMC 432696	ROCKSTAR 359	2015-3942				SEC04-T06S-R25E
AMC 432697	ROCKSTAR 360	2015-3943				SEC04-T06S-R25E
AMC 432698	ROCKSTAR 361	2015-3944				SEC04-T06S-R25E
AMC 432699	ROCKSTAR 362	2015-3945				SEC04-T06S-R25E
AMC 432700	ROCKSTAR 363	2015-3946				SEC04-T06S-R25E
AMC 432701	ROCKSTAR 364	2015-3947				SEC04-T06S-R25E
AMC 432702	ROCKSTAR 365	2015-3948				SEC04-T06S-R25E
AMC 432703	ROCKSTAR 366	2015-3949				SEC04-T06S-R25E
AMC 432704	ROCKSTAR 367	2015-3950				SEC04-T06S-R25E
AMC 432705	ROCKSTAR 368	2015-3951				SEC03-T06S-R25E
AMC 432706	ROCKSTAR 369	2015-3952				SEC03-T06S-R25E
AMC 432707	ROCKSTAR 370	2015-3953				SEC03-T06S-R25E
AMC 432708	ROCKSTAR 371	2015-3954				SEC03-T06S-R25E
AMC 432709	ROCKSTAR 372	2015-3955				SEC03-T06S-R25E
AMC 432710	ROCKSTAR 373	2015-3956				SEC03-T06S-R25E
AMC 432711	ROCKSTAR 374	2015-3957				SEC03-T06S-R25E
AMC 432712	ROCKSTAR 375	2015-3958				SEC03-T06S-R25E
AMC 432713	ROCKSTAR 376	2015-3959				SEC03-T06S-R25E
AMC 432714	ROCKSTAR 377	2015-3960				SEC03-T06S-R25E
AMC 432715	ROCKSTAR 378	2015-3961				SEC03-T06S-R25E

Date: 6/1/2017

RECEIVED  
BLM AZ STATE OFFICE  
JUL 12 A 10:48  
PHOENIX, ARIZONA



## Exhibit A

County: Graham

State: AZ

Original Recording

Amended Recording

<u>BLM Serial #</u>	<u>Claim Name</u>	<u>Recording #</u>	<u>Page #</u>	<u>Recording #</u>	<u>Page #</u>	<u>Location</u>
AMC 432716	ROCKSTAR 379	2015-3962				SEC03-T06S-R25E
AMC 432717	ROCKSTAR 380	2015-3963				SEC03-T06S-R25E
AMC 432718	ROCKSTAR 381	2015-3964				SEC03-T06S-R25E
AMC 432719	ROCKSTAR 382	2015-3965				SEC03-T06S-R25E
AMC 432720	ROCKSTAR 383	2015-3966				SEC03-T06S-R25E
AMC 432721	ROCKSTAR 384	2015-3967				SEC03-T06S-R25E
AMC 432722	ROCKSTAR 385	2015-3968				SEC03-T06S-R25E
AMC 432723	ROCKSTAR 386	2015-3969				SEC03-T06S-R25E
AMC 432724	ROCKSTAR 387	2015-3970				SEC03-T06S-R25E
AMC 432725	ROCKSTAR 388	2015-3971				SEC03-T06S-R25E
AMC 432726	ROCKSTAR 389	2015-3972				SEC03-T06S-R25E
AMC 432727	ROCKSTAR 390	2015-3973				SEC03-T06S-R25E
AMC 432728	ROCKSTAR 391	2015-3974				SEC03-T06S-R25E
AMC 432729	ROCKSTAR 392	2015-3975				SEC03-T06S-R25E
AMC 432730	ROCKSTAR 393	2015-3976				SEC03-T06S-R25E
AMC 432731	ROCKSTAR 394	2015-3977				SEC03-T06S-R25E
AMC 432732	ROCKSTAR 395	2015-3978				SEC03-T06S-R25E
AMC 432733	ROCKSTAR 396	2015-3979				SEC03-T06S-R25E
AMC 432734	ROCKSTAR 397	2015-3980				SEC03-T06S-R25E
AMC 432735	ROCKSTAR 398	2015-3981				SEC03-T06S-R25E
AMC 432736	ROCKSTAR 399	2015-3982				SEC03-T06S-R25E
AMC 432737	ROCKSTAR 400	2015-3983				SEC03-T06S-R25E
AMC 432738	ROCKSTAR 401	2015-3984				SEC03-T06S-R25E
AMC 432739	ROCKSTAR 402	2015-3985				SEC03-T06S-R25E
AMC 432740	ROCKSTAR 403	2015-3986				SEC02-T06S-R25E
AMC 432741	ROCKSTAR 404	2015-3987				SEC02-T06S-R25E
AMC 432742	ROCKSTAR 405	2015-3988				SEC02-T06S-R25E
AMC 432743	ROCKSTAR 406	2015-3989				SEC02-T06S-R25E
AMC 432744	ROCKSTAR 407	2015-3990				SEC02-T06S-R25E
AMC 432745	ROCKSTAR 408	2015-3991				SEC02-T06S-R25E
AMC 432746	ROCKSTAR 409	2015-3992				SEC02-T06S-R25E
AMC 432747	ROCKSTAR 410	2015-3993				SEC02-T06S-R25E
AMC 432748	ROCKSTAR 411	2015-3994				SEC02-T06S-R25E
AMC 432749	ROCKSTAR 412	2015-3995				SEC02-T06S-R25E
AMC 432750	ROCKSTAR 413	2015-3996				SEC02-T06S-R25E
AMC 432751	ROCKSTAR 414	2015-3997				SEC02-T06S-R25E
AMC 432752	ROCKSTAR 415	2015-3998				SEC02-T06S-R25E
AMC 432753	ROCKSTAR 416	2015-3999				SEC02-T06S-R25E

Date: 6/1/2017

RECEIVED  
BLM AZ STATE OFFICE  
2017 JUL 12 A 10:48  
PHOENIX, ARIZONA

## Exhibit A

County: Graham

State: AZ

Original Recording

Amended Recording

<u>BLM Serial #</u>	<u>Claim Name</u>	<u>Recording #</u>	<u>Page #</u>	<u>Recording #</u>	<u>Page #</u>	<u>Location</u>
AMC 432754	ROCKSTAR 417	2015-4000				SEC02-T06S-R25E
AMC 432755	ROCKSTAR 418	2015-4001				SEC02-T06S-R25E
AMC 432756	ROCKSTAR 419	2015-4002				SEC02-T06S-R25E
AMC 432757	ROCKSTAR 420	2015-4003				SEC02-T06S-R25E
AMC 432758	ROCKSTAR 421	2015-4004				SEC02-T06S-R25E
AMC 432759	ROCKSTAR 422	2015-4005				SEC02-T06S-R25E
AMC 432760	ROCKSTAR 423	2015-4006				SEC02-T06S-R25E
AMC 432761	ROCKSTAR 424	2015-4007				SEC02-T06S-R25E
AMC 432762	ROCKSTAR 425	2015-4008				SEC02-T06S-R25E
AMC 432763	ROCKSTAR 426	2015-4009				SEC02-T06S-R25E
AMC 432764	ROCKSTAR 427	2015-4010				SEC02-T06S-R25E
AMC 432765	ROCKSTAR 428	2015-4011				SEC02-T06S-R25E
AMC 432766	ROCKSTAR 429	2015-4012				SEC02-T06S-R25E
AMC 432767	ROCKSTAR 430	2015-4013				SEC02-T06S-R25E
AMC 432768	ROCKSTAR 431	2015-4014				SEC08-T06S-R25E
AMC 432769	ROCKSTAR 432	2015-4015				SEC08-T06S-R25E
AMC 432770	ROCKSTAR 433	2015-4016				SEC08-T06S-R25E
AMC 432771	ROCKSTAR 434	2015-4017				SEC08-T06S-R25E
AMC 432772	ROCKSTAR 435	2015-4018				SEC08-T06S-R25E
AMC 432773	ROCKSTAR 436	2015-4019				SEC08-T06S-R25E
AMC 432774	ROCKSTAR 437	2015-4020				SEC08-T06S-R25E
AMC 432775	ROCKSTAR 438	2015-4021				SEC08-T06S-R25E
AMC 432776	ROCKSTAR 439	2015-4022				SEC08-T06S-R25E
AMC 432777	ROCKSTAR 440	2015-4023				SEC08-T06S-R25E
AMC 432778	ROCKSTAR 441	2015-4024				SEC08-T06S-R25E
AMC 432779	ROCKSTAR 442	2015-4025				SEC08-T06S-R25E
AMC 432780	ROCKSTAR 443	2015-4026				SEC08-T06S-R25E
AMC 432781	ROCKSTAR 444	2015-4027				SEC08-T06S-R25E
AMC 432782	ROCKSTAR 445	2015-4028				SEC08-T06S-R25E
AMC 432783	ROCKSTAR 446	2015-4029				SEC08-T06S-R25E
AMC 432784	ROCKSTAR 447	2015-4030				SEC08-T06S-R25E
AMC 432785	ROCKSTAR 448	2015-4031				SEC08-T06S-R25E
AMC 432786	ROCKSTAR 449	2015-4032				SEC08-T06S-R25E
AMC 432787	ROCKSTAR 450	2015-4033				SEC08-T06S-R25E
AMC 432788	ROCKSTAR 451	2015-4034				SEC08-T06S-R25E
AMC 432789	ROCKSTAR 452	2015-4035				SEC08-T06S-R25E
AMC 432790	ROCKSTAR 453	2015-4036				SEC08-T06S-R25E
AMC 432791	ROCKSTAR 454	2015-4037				SEC09-T06S-R25E

Date: 6/1/2017

RECEIVED  
BLM AZ STATE OFFICE  
2017 JUL 12 A 10:49  
PHOENIX, ARIZONA

## Exhibit A

County: Graham

State: AZ

Original Recording

Amended Recording

<u>BLM Serial #</u>	<u>Claim Name</u>	<u>Recording #</u>	<u>Page #</u>	<u>Recording #</u>	<u>Page #</u>	<u>Location</u>
AMC 432792	ROCKSTAR 455	2015-4038				SEC09-T06S-R25E
AMC 432793	ROCKSTAR 456	2015-4039				SEC09-T06S-R25E
AMC 432794	ROCKSTAR 457	2015-4040				SEC09-T06S-R25E
AMC 432795	ROCKSTAR 458	2015-4041				SEC09-T06S-R25E
AMC 432796	ROCKSTAR 459	2015-4042				SEC09-T06S-R25E
AMC 432797	ROCKSTAR 460	2015-4043				SEC09-T06S-R25E
AMC 432798	ROCKSTAR 461	2015-4044				SEC09-T06S-R25E
AMC 432799	ROCKSTAR 462	2015-4045				SEC09-T06S-R25E
AMC 432800	ROCKSTAR 463	2015-4046				SEC09-T06S-R25E
AMC 432801	ROCKSTAR 464	2015-4047				SEC09-T06S-R25E
AMC 432802	ROCKSTAR 465	2015-4048				SEC09-T06S-R25E
AMC 432803	ROCKSTAR 466	2015-4049				SEC09-T06S-R25E
AMC 432804	ROCKSTAR 467	2015-4050				SEC09-T06S-R25E
AMC 432805	ROCKSTAR 468	2015-4051				SEC09-T06S-R25E
AMC 432806	ROCKSTAR 469	2015-4052				SEC09-T06S-R25E
AMC 432807	ROCKSTAR 470	2015-4053				SEC09-T06S-R25E
AMC 432808	ROCKSTAR 471	2015-4054				SEC09-T06S-R25E
AMC 432809	ROCKSTAR 472	2015-4055				SEC10-T06S-R25E
AMC 432810	ROCKSTAR 473	2015-4056				SEC10-T06S-R25E
AMC 432811	ROCKSTAR 474	2015-4057				SEC10-T06S-R25E
AMC 432812	ROCKSTAR 475	2015-4058				SEC10-T06S-R25E
AMC 432813	ROCKSTAR 476	2015-4059				SEC10-T06S-R25E
AMC 432814	ROCKSTAR 477	2015-4060				SEC10-T06S-R25E
AMC 432815	ROCKSTAR 478	2015-4061				SEC10-T06S-R25E
AMC 432816	ROCKSTAR 479	2015-4062				SEC10-T06S-R25E
AMC 432817	ROCKSTAR 480	2015-4063				SEC10-T06S-R25E
AMC 432818	ROCKSTAR 481	2015-4064				SEC10-T06S-R25E
AMC 432819	ROCKSTAR 482	2015-4065				SEC10-T06S-R25E
AMC 432820	ROCKSTAR 483	2015-4066				SEC10-T06S-R25E
AMC 432821	ROCKSTAR 484	2015-4067				SEC10-T06S-R25E
AMC 432822	ROCKSTAR 485	2015-4068				SEC10-T06S-R25E
AMC 432823	ROCKSTAR 486	2015-4069				SEC10-T06S-R25E
AMC 432824	ROCKSTAR 487	2015-4070				SEC10-T06S-R25E
AMC 432825	ROCKSTAR 488	2015-4071				SEC10-T06S-R25E
AMC 432826	ROCKSTAR 489	2015-4072				SEC10-T06S-R25E
AMC 432827	ROCKSTAR 490	2015-4073				SEC10-T06S-R25E
AMC 432828	ROCKSTAR 491	2015-4074				SEC10-T06S-R25E
AMC 432829	ROCKSTAR 492	2015-4075				SEC10-T06S-R25E

RECEIVED  
BLM AZ STATE OFFICE  
2017 JUL 12 A 10:49  
PHOENIX, ARIZONA

Date: 6/1/2017

## Exhibit A

County: Graham

State: AZ

<u>BLM Serial #</u>	<u>Claim Name</u>	<u>Original Recording</u>		<u>Amended Recording</u>		<u>Location</u>
		<u>Recording #</u>	<u>Page #</u>	<u>Recording #</u>	<u>Page #</u>	
AMC 432830	ROCKSTAR 493	2015-4076				SEC10-T06S-R25E
AMC 432831	ROCKSTAR 494	2015-4077				SEC10-T06S-R25E
AMC 432832	ROCKSTAR 495	2015-4078				SEC10-T06S-R25E
AMC 432833	ROCKSTAR 496	2015-4079				SEC10-T06S-R25E
AMC 432834	ROCKSTAR 497	2015-4080				SEC10-T06S-R25E
AMC 432835	ROCKSTAR 498	2015-4081				SEC10-T06S-R25E
AMC 432836	ROCKSTAR 499	2015-4082				SEC10-T06S-R25E
AMC 432837	ROCKSTAR 500	2015-4083				SEC10-T06S-R25E
AMC 432838	ROCKSTAR 501	2015-4084				SEC10-T06S-R25E
AMC 432839	ROCKSTAR 502	2015-4085				SEC10-T06S-R25E
AMC 432840	ROCKSTAR 503	2015-4086				SEC10-T06S-R25E
AMC 432841	ROCKSTAR 504	2015-4087				SEC10-T06S-R25E
AMC 432842	ROCKSTAR 505	2015-4088				SEC10-T06S-R25E
AMC 432843	ROCKSTAR 506	2015-4089				SEC10-T06S-R25E
AMC 432844	ROCKSTAR 507	2015-4090				SEC11-T06S-R25E
AMC 432845	ROCKSTAR 508	2015-4091				SEC11-T06S-R25E
AMC 432846	ROCKSTAR 509	2015-4092				SEC11-T06S-R25E
AMC 432847	ROCKSTAR 510	2015-4093				SEC11-T06S-R25E
AMC 432848	ROCKSTAR 511	2015-4094				SEC11-T06S-R25E
AMC 432849	ROCKSTAR 512	2015-4095				SEC11-T06S-R25E
AMC 432850	ROCKSTAR 513	2015-4096				SEC11-T06S-R25E
AMC 432851	ROCKSTAR 514	2015-4097				SEC11-T06S-R25E
AMC 432852	ROCKSTAR 515	2015-4098				SEC11-T06S-R25E
AMC 432853	ROCKSTAR 516	2015-4099				SEC11-T06S-R25E
AMC 432854	ROCKSTAR 517	2015-4100				SEC11-T06S-R25E
AMC 432855	ROCKSTAR 518	2015-4101				SEC11-T06S-R25E
AMC 432856	ROCKSTAR 519	2015-4102				SEC11-T06S-R25E
AMC 432857	ROCKSTAR 520	2015-4103				SEC11-T06S-R25E
AMC 432858	ROCKSTAR 521	2015-4104				SEC11-T06S-R25E
AMC 432859	ROCKSTAR 522	2015-4105				SEC11-T06S-R25E
AMC 432860	ROCKSTAR 523	2015-4106				SEC11-T06S-R25E
AMC 432861	ROCKSTAR 524	2015-4107				SEC11-T06S-R25E
AMC 432862	ROCKSTAR 525	2015-4108				SEC11-T06S-R25E
AMC 432863	ROCKSTAR 526	2015-4109				SEC11-T06S-R25E
AMC 432864	ROCKSTAR 527	2015-4110				SEC11-T06S-R25E
AMC 432865	ROCKSTAR 528	2015-4111				SEC11-T06S-R25E
AMC 432866	ROCKSTAR 529	2015-4112				SEC11-T06S-R25E
AMC 432867	ROCKSTAR 530	2015-4113				SEC11-T06S-R25E

Date: 6/1/2017

RECEIVED  
 BLM AZ STATE OFFICE  
 2017 JUL 12 A 10:49  
 PHOENIX, ARIZONA

## Exhibit A

County: Graham

State: AZ

Original Recording

Amended Recording

<u>BLM Serial #</u>	<u>Claim Name</u>	<u>Recording #</u>	<u>Page #</u>	<u>Recording #</u>	<u>Page #</u>	<u>Location</u>
AMC 432868	ROCKSTAR 531	2015-4114				SEC11-T06S-R25E
AMC 432869	ROCKSTAR 532	2015-4115				SEC11-T06S-R25E
AMC 432870	ROCKSTAR 533	2015-4116				SEC11-T06S-R25E
AMC 432871	ROCKSTAR 534	2015-4117				SEC15-T06S-R25E
AMC 432872	ROCKSTAR 535	2015-4118				SEC15-T06S-R25E
AMC 432873	ROCKSTAR 536	2015-4119				SEC15-T06S-R25E
AMC 432874	ROCKSTAR 537	2015-4120				SEC15-T06S-R25E
AMC 432875	ROCKSTAR 538	2015-4121				SEC15-T06S-R25E
AMC 432876	ROCKSTAR 539	2015-4122				SEC15-T06S-R25E
AMC 432877	ROCKSTAR 540	2015-4123				SEC15-T06S-R25E
AMC 432878	ROCKSTAR 541	2015-4124				SEC15-T06S-R25E
AMC 432879	ROCKSTAR 542	2015-4125				SEC15-T06S-R25E
AMC 432880	ROCKSTAR 543	2015-4126				SEC15-T06S-R25E
AMC 432881	ROCKSTAR 544	2015-4127				SEC15-T06S-R25E
AMC 432882	ROCKSTAR 545	2015-4128				SEC15-T06S-R25E
AMC 432883	ROCKSTAR 546	2015-4129				SEC15-T06S-R25E
AMC 432884	ROCKSTAR 547	2015-4130				SEC15-T06S-R25E
AMC 432885	ROCKSTAR 548	2015-4131				SEC15-T06S-R25E
AMC 432886	ROCKSTAR 549	2015-4132				SEC15-T06S-R25E
AMC 432887	ROCKSTAR 550	2015-4133				SEC15-T06S-R25E
AMC 432888	ROCKSTAR 551	2015-4134				SEC15-T06S-R25E
AMC 432889	ROCKSTAR 552	2015-4135				SEC15-T06S-R25E
AMC 432890	ROCKSTAR 553	2015-4136				SEC15-T06S-R25E
AMC 432891	ROCKSTAR 554	2015-4137				SEC15-T06S-R25E
AMC 432892	ROCKSTAR 555	2015-4138				SEC15-T06S-R25E
AMC 432893	ROCKSTAR 556	2015-4139				SEC15-T06S-R25E
AMC 432894	ROCKSTAR 557	2015-4140				SEC15-T06S-R25E
AMC 432895	ROCKSTAR 558	2015-4141				SEC15-T06S-R25E
AMC 432896	ROCKSTAR 559	2015-4142				SEC15-T06S-R25E
AMC 432897	ROCKSTAR 560	2015-4143				SEC15-T06S-R25E
AMC 432898	ROCKSTAR 561	2015-4144				SEC15-T06S-R25E
AMC 432899	ROCKSTAR 562	2015-4145				SEC15-T06S-R25E
AMC 432900	ROCKSTAR 563	2015-4146				SEC15-T06S-R25E
AMC 432901	ROCKSTAR 564	2015-4147				SEC14-T06S-R25E
AMC 432902	ROCKSTAR 565	2015-4148				SEC14-T06S-R25E
AMC 432903	ROCKSTAR 566	2015-4149				SEC14-T06S-R25E
AMC 432904	ROCKSTAR 567	2015-4150				SEC14-T06S-R25E
AMC 432905	ROCKSTAR 568	2015-4151				SEC14-T06S-R25E

Date: 6/1/2017

RECEIVED  
BLM AZ STATE OFFICE  
2017 JUL 12 A 10:49  
PHOENIX, ARIZONA

## Exhibit A

County: Graham

State: AZ

Original Recording

Amended Recording

<u>BLM Serial #</u>	<u>Claim Name</u>	<u>Recording #</u>	<u>Page #</u>	<u>Recording #</u>	<u>Page #</u>	<u>Location</u>
AMC 432906	ROCKSTAR 569	2015-4152				SEC14-T06S-R25E
AMC 432907	ROCKSTAR 570	2015-4153				SEC14-T06S-R25E
AMC 432908	ROCKSTAR 571	2015-4154				SEC14-T06S-R25E
AMC 432909	ROCKSTAR 572	2015-4155				SEC14-T06S-R25E
AMC 432910	ROCKSTAR 573	2015-4156				SEC14-T06S-R25E
AMC 432911	ROCKSTAR 574	2015-4157				SEC14-T06S-R25E
AMC 432912	ROCKSTAR 575	2015-4158				SEC14-T06S-R25E
AMC 432913	ROCKSTAR 576	2015-4159				SEC14-T06S-R25E
AMC 432914	ROCKSTAR 577	2015-4160				SEC14-T06S-R25E
AMC 432915	ROCKSTAR 578	2015-4161				SEC14-T06S-R25E
AMC 432916	ROCKSTAR 579	2015-4162				SEC14-T06S-R25E
AMC 432917	ROCKSTAR 580	2015-4163				SEC14-T06S-R25E
AMC 432918	ROCKSTAR 581	2015-4164				SEC14-T06S-R25E
AMC 432919	ROCKSTAR 582	2015-4165				SEC14-T06S-R25E
AMC 432920	ROCKSTAR 583	2015-4166				SEC14-T06S-R25E
AMC 432921	ROCKSTAR 584	2015-4167				SEC14-T06S-R25E
AMC 432922	ROCKSTAR 585	2015-4168				SEC14-T06S-R25E
AMC 432923	ROCKSTAR 586	2015-4169				SEC14-T06S-R25E
AMC 432924	ROCKSTAR 587	2015-4170				SEC14-T06S-R25E
AMC 432925	ROCKSTAR 588	2015-4171				SEC14-T06S-R25E
AMC 432926	ROCKSTAR 589	2015-4172				SEC14-T06S-R25E
AMC 432927	ROCKSTAR 590	2015-4173				SEC14-T06S-R25E
AMC 432928	ROCKSTAR 591	2015-4174				SEC14-T06S-R25E
AMC 432929	ROCKSTAR 592	2015-4175				SEC14-T06S-R25E
AMC 432930	ROCKSTAR 593	2015-4176				SEC14-T06S-R25E
AMC 432931	ROCKSTAR 594	2015-4177				SEC14-T06S-R25E
AMC 432994	ROCKSTAR 595	2015-4259				SEC13-T06S-R25E
AMC 432995	ROCKSTAR 596	2015-4260				SEC13-T06S-R25E
AMC 432996	ROCKSTAR 597	2015-4261				SEC13-T06S-R25E
AMC 432997	ROCKSTAR 598	2015-4262				SEC13-T06S-R25E
AMC 432998	ROCKSTAR 599	2015-4263				SEC13-T06S-R25E
AMC 432999	ROCKSTAR 600	2015-4264				SEC13-T06S-R25E
AMC 433000	ROCKSTAR 601	2015-4265				SEC13-T06S-R25E
AMC 433001	ROCKSTAR 602	2015-4266				SEC13-T06S-R25E
AMC 433002	ROCKSTAR 603	2015-4267				SEC13-T06S-R25E
AMC 433003	ROCKSTAR 604	2015-4268				SEC13-T06S-R25E
AMC 433004	ROCKSTAR 605	2015-4269				SEC13-T06S-R25E
AMC 433005	ROCKSTAR 606	2015-4270				SEC13-T06S-R25E

Date: 6/1/2017

RECEIVED  
 BLM AZ STATE OFFICE  
 2017 JUL 12 A 10:49  
 PHOENIX, ARIZONA

## Exhibit A

County: Graham

State: AZ

Original Recording

Amended Recording

<u>BLM Serial #</u>	<u>Claim Name</u>	<u>Recording #</u>	<u>Page #</u>	<u>Recording #</u>	<u>Page #</u>	<u>Location</u>
AMC 433006	ROCKSTAR 607	2015-4271				SEC13-T06S-R25E
AMC 433007	ROCKSTAR 608	2015-4272				SEC13-T06S-R25E
AMC 433008	ROCKSTAR 609	2015-4273				SEC13-T06S-R25E
AMC 433009	ROCKSTAR 610	2015-4274				SEC13-T06S-R25E
AMC 433010	ROCKSTAR 611	2015-4275				SEC13-T06S-R25E
AMC 433011	ROCKSTAR 612	2015-4276				SEC13-T06S-R25E
AMC 433012	ROCKSTAR 613	2015-4277				SEC13-T06S-R25E
AMC 433013	ROCKSTAR 614	2015-4278				SEC13-T06S-R25E
AMC 433014	ROCKSTAR 615	2015-4279				SEC23-T06S-R25E
AMC 433015	ROCKSTAR 616	2015-4280				SEC23-T06S-R25E
AMC 433016	ROCKSTAR 617	2015-4281				SEC23-T06S-R25E
AMC 433017	ROCKSTAR 618	2015-4282				SEC23-T06S-R25E
AMC 433018	ROCKSTAR 619	2015-4283				SEC23-T06S-R25E
AMC 433019	ROCKSTAR 620	2015-4284				SEC23-T06S-R25E
AMC 433020	ROCKSTAR 621	2015-4285				SEC23-T06S-R25E
AMC 433021	ROCKSTAR 622	2015-4286				SEC23-T06S-R25E
AMC 433022	ROCKSTAR 623	2015-4287				SEC23-T06S-R25E
AMC 433023	ROCKSTAR 624	2015-4288				SEC23-T06S-R25E
AMC 433024	ROCKSTAR 625	2015-4289				SEC23-T06S-R25E
AMC 433025	ROCKSTAR 626	2015-4290				SEC23-T06S-R25E
AMC 433026	ROCKSTAR 627	2015-4291				SEC23-T06S-R25E
AMC 433027	ROCKSTAR 628	2015-4292				SEC23-T06S-R25E
AMC 433028	ROCKSTAR 629	2015-4293				SEC23-T06S-R25E
AMC 433029	ROCKSTAR 630	2015-4294				SEC23-T06S-R25E
AMC 433030	ROCKSTAR 631	2015-4295				SEC23-T06S-R25E
AMC 433031	ROCKSTAR 632	2015-4296				SEC23-T06S-R25E
AMC 433032	ROCKSTAR 633	2015-4297				SEC23-T06S-R25E
AMC 433033	ROCKSTAR 634	2015-4298				SEC23-T06S-R25E
AMC 433034	ROCKSTAR 635	2015-4299				SEC23-T06S-R25E
AMC 433035	ROCKSTAR 636	2015-4300				SEC23-T06S-R25E
AMC 433036	ROCKSTAR 637	2015-4301				SEC23-T06S-R25E
AMC 433037	ROCKSTAR 638	2015-4302				SEC23-T06S-R25E
AMC 433038	ROCKSTAR 639	2015-4303				SEC23-T06S-R25E
AMC 433039	ROCKSTAR 640	2015-4304				SEC23-T06S-R25E
AMC 433040	ROCKSTAR 641	2015-4305				SEC23-T06S-R25E
AMC 433041	ROCKSTAR 642	2015-4306				SEC23-T06S-R25E
AMC 433042	ROCKSTAR 643	2015-4307				SEC23-T06S-R25E
AMC 433043	ROCKSTAR 644	2015-4308				SEC23-T06S-R25E

RECEIVED  
BLM AZ STATE OFFICE  
JUL 12 A 10:47  
PHOENIX, ARIZONA

Date: 6/1/2017

# Exhibit A

County: Graham

State: AZ

Original Recording

Amended Recording

<u>BLM Serial #</u>	<u>Claim Name</u>	<u>Recording #</u>	<u>Page #</u>	<u>Recording #</u>	<u>Page #</u>	<u>Location</u>
AMC 433044	ROCKSTAR 645	2015-4309				SEC23-T06S-R25E
AMC 433045	ROCKSTAR 646	2015-4310				SEC23-T06S-R25E
AMC 433046	ROCKSTAR 647	2015-4311				SEC24-T06S-R25E
AMC 433047	ROCKSTAR 648	2015-4312				SEC24-T06S-R25E
AMC 433048	ROCKSTAR 649	2015-4313				SEC24-T06S-R25E
AMC 433049	ROCKSTAR 650	2015-4314				SEC24-T06S-R25E
AMC 433050	ROCKSTAR 651	2015-4315				SEC24-T06S-R25E
AMC 433051	ROCKSTAR 652	2015-4316				SEC24-T06S-R25E
AMC 433052	ROCKSTAR 653	2015-4317				SEC24-T06S-R25E
AMC 433053	ROCKSTAR 654	2015-4318				SEC24-T06S-R25E
AMC 433054	ROCKSTAR 655	2015-4319				SEC24-T06S-R25E
AMC 433055	ROCKSTAR 656	2015-4320				SEC24-T06S-R25E
AMC 433056	ROCKSTAR 657	2015-4321				SEC24-T06S-R25E
AMC 433057	ROCKSTAR 658	2015-4322				SEC24-T06S-R25E
AMC 433058	ROCKSTAR 659	2015-4323				SEC24-T06S-R25E
AMC 433059	ROCKSTAR 660	2015-4324				SEC24-T06S-R25E
AMC 433060	ROCKSTAR 661	2015-4325				SEC24-T06S-R25E
AMC 433061	ROCKSTAR 662	2015-4326				SEC24-T06S-R25E
AMC 433062	ROCKSTAR 663	2015-4327				SEC24-T06S-R25E
AMC 433063	ROCKSTAR 664	2015-4328				SEC24-T06S-R25E
AMC 433064	ROCKSTAR 665	2015-4329				SEC24-T06S-R25E
AMC 433065	ROCKSTAR 666	2015-4330				SEC24-T06S-R25E
AMC 433066	ROCKSTAR 667	2015-4331				SEC24-T06S-R25E
AMC 433067	ROCKSTAR 668	2015-4332				SEC24-T06S-R25E
AMC 433068	ROCKSTAR 669	2015-4333				SEC24-T06S-R25E
AMC 433069	ROCKSTAR 670	2015-4334				SEC24-T06S-R25E
AMC 433070	ROCKSTAR 671	2015-4335				SEC24-T06S-R25E
AMC 433071	ROCKSTAR 672	2015-4336				SEC24-T06S-R25E
AMC 433072	ROCKSTAR 673	2015-4337				SEC24-T06S-R25E
AMC 433073	ROCKSTAR 674	2015-4338				SEC24-T06S-R25E
AMC 433074	ROCKSTAR 675	2015-4339				SEC24-T06S-R25E
AMC 433075	ROCKSTAR 676	2015-4340				SEC24-T06S-R25E
AMC 433076	ROCKSTAR 677	2015-4341				SEC24-T06S-R25E
AMC 433077	ROCKSTAR 678	2015-4342				SEC24-T06S-R25E
AMC 433078	ROCKSTAR 679	2015-4343				SEC24-T06S-R25E
AMC 433079	ROCKSTAR 680	2015-4344				SEC24-T06S-R25E
AMC 433080	ROCKSTAR 681	2015-4345				SEC24-T06S-R25E
AMC 433081	ROCKSTAR 682	2015-4346				SEC24-T06S-R25E

Date: 6/1/2017

RECEIVED  
BLM AZ STATE OFFICE  
2017 JUL 12 A 10:49  
PHOENIX, ARIZONA



## Exhibit A

County: Graham

State: AZ

Original Recording

Amended Recording

<u>BLM Serial #</u>	<u>Claim Name</u>	<u>Recording #</u>	<u>Page #</u>	<u>Recording #</u>	<u>Page #</u>	<u>Location</u>
AMC 433082	ROCKSTAR 683	2015-4347				SEC25-T06S-R25E
AMC 433083	ROCKSTAR 684	2015-4348				SEC25-T06S-R25E
AMC 433084	ROCKSTAR 685	2015-4349				SEC25-T06S-R25E
AMC 433085	ROCKSTAR 686	2015-4350				SEC25-T06S-R25E
AMC 433086	ROCKSTAR 687	2015-4351				SEC25-T06S-R25E
AMC 433087	ROCKSTAR 688	2015-4352				SEC25-T06S-R25E
AMC 433088	ROCKSTAR 689	2015-4353				SEC25-T06S-R25E
AMC 433089	ROCKSTAR 690	2015-4354				SEC25-T06S-R25E
AMC 433090	ROCKSTAR 691	2015-4355				SEC25-T06S-R25E
AMC 433091	ROCKSTAR 692	2015-4356				SEC25-T06S-R25E
AMC 433092	ROCKSTAR 693	2015-4357				SEC25-T06S-R25E
AMC 433093	ROCKSTAR 694	2015-4358				SEC25-T06S-R25E
AMC 433094	ROCKSTAR 695	2015-4359				SEC25-T06S-R25E
AMC 433095	ROCKSTAR 696	2015-4360				SEC25-T06S-R25E
AMC 433096	ROCKSTAR 697	2015-4361				SEC25-T06S-R25E
AMC 433097	ROCKSTAR 698	2015-4362				SEC25-T06S-R25E
AMC 433098	ROCKSTAR 699	2015-4363				SEC25-T06S-R25E
AMC 433099	ROCKSTAR 700	2015-4364				SEC25-T06S-R25E
AMC 433100	ROCKSTAR 701	2015-4365				SEC25-T06S-R25E
AMC 433101	ROCKSTAR 702	2015-4366				SEC25-T06S-R25E
AMC 433102	ROCKSTAR 703	2015-4367				SEC25-T06S-R25E
AMC 433103	ROCKSTAR 704	2015-4368				SEC25-T06S-R25E
AMC 433104	ROCKSTAR 705	2015-4369				SEC25-T06S-R25E
AMC 433105	ROCKSTAR 706	2015-4370				SEC25-T06S-R25E
AMC 433106	ROCKSTAR 707	2015-4371				SEC25-T06S-R25E
AMC 433107	ROCKSTAR 708	2015-4372				SEC25-T06S-R25E
AMC 433108	ROCKSTAR 709	2015-4373				SEC25-T06S-R25E
AMC 433109	ROCKSTAR 710	2015-4374				SEC18-T06S-R26E
AMC 433110	ROCKSTAR 711	2015-4375				SEC18-T06S-R26E
AMC 433111	ROCKSTAR 712	2015-4376				SEC18-T06S-R26E
AMC 433112	ROCKSTAR 713	2015-4377				SEC18-T06S-R26E
AMC 433113	ROCKSTAR 714	2015-4378				SEC18-T06S-R26E
AMC 433114	ROCKSTAR 715	2015-4379				SEC18-T06S-R26E
AMC 433115	ROCKSTAR 716	2015-4380				SEC18-T06S-R26E
AMC 433116	ROCKSTAR 717	2015-4381				SEC18-T06S-R26E
AMC 433117	ROCKSTAR 718	2015-4382				SEC18-T06S-R26E
AMC 433118	ROCKSTAR 719	2015-4383				SEC18-T06S-R26E
AMC 433119	ROCKSTAR 720	2015-4384				SEC18-T06S-R26E

Date: 6/1/2017

RECEIVED  
BLM AZ STATE OFFICE  
JUL 12 A 10:49  
PHOENIX, ARIZONA

## Exhibit A

County: Graham

State: AZ

<u>BLM Serial #</u>	<u>Claim Name</u>	<u>Original Recording</u>		<u>Amended Recording</u>		<u>Location</u>
		<u>Recording #</u>	<u>Page #</u>	<u>Recording #</u>	<u>Page #</u>	
AMC 433120	ROCKSTAR 721	2015-4385				SEC18-T06S-R26E
AMC 433121	ROCKSTAR 722	2015-4386				SEC18-T06S-R26E
AMC 433122	ROCKSTAR 723	2015-4387				SEC18-T06S-R26E
AMC 433123	ROCKSTAR 724	2015-4388				SEC18-T06S-R26E
AMC 433124	ROCKSTAR 725	2015-4389				SEC18-T06S-R26E
AMC 433125	ROCKSTAR 726	2015-4390				SEC18-T06S-R26E
AMC 433126	ROCKSTAR 727	2015-4391				SEC19-T06S-R26E
AMC 433127	ROCKSTAR 728	2015-4392				SEC19-T06S-R26E
AMC 433128	ROCKSTAR 729	2015-4393				SEC19-T06S-R26E
AMC 433129	ROCKSTAR 730	2015-4394				SEC19-T06S-R26E
AMC 433130	ROCKSTAR 731	2015-4395				SEC19-T06S-R26E
AMC 433131	ROCKSTAR 732	2015-4396				SEC19-T06S-R26E
AMC 433132	ROCKSTAR 733	2015-4397				SEC19-T06S-R26E
AMC 433133	ROCKSTAR 734	2015-4398				SEC19-T06S-R26E
AMC 433134	ROCKSTAR 735	2015-4399				SEC19-T06S-R26E
AMC 433135	ROCKSTAR 736	2015-4400				SEC19-T06S-R26E
AMC 433136	ROCKSTAR 737	2015-4401				SEC19-T06S-R26E
AMC 433137	ROCKSTAR 738	2015-4402				SEC19-T06S-R26E
AMC 433138	ROCKSTAR 739	2015-4403				SEC19-T06S-R26E
AMC 433139	ROCKSTAR 740	2015-4404				SEC19-T06S-R26E
AMC 433140	ROCKSTAR 741	2015-4405				SEC19-T06S-R26E
AMC 433141	ROCKSTAR 742	2015-4406				SEC19-T06S-R26E
AMC 433142	ROCKSTAR 743	2015-4407				SEC19-T06S-R26E
AMC 433143	ROCKSTAR 744	2015-4408				SEC19-T06S-R26E
AMC 433144	ROCKSTAR 745	2015-4409				SEC19-T06S-R26E
AMC 433145	ROCKSTAR 746	2015-4410				SEC19-T06S-R26E
AMC 433146	ROCKSTAR 747	2015-4411				SEC19-T06S-R26E
AMC 433147	ROCKSTAR 748	2015-4412				SEC19-T06S-R26E
AMC 433148	ROCKSTAR 749	2015-4413				SEC19-T06S-R26E
AMC 433149	ROCKSTAR 750	2015-4414				SEC19-T06S-R26E
AMC 433150	ROCKSTAR 751	2015-4415				SEC19-T06S-R26E
AMC 433151	ROCKSTAR 752	2015-4416				SEC19-T06S-R26E
AMC 433152	ROCKSTAR 753	2015-4417				SEC19-T06S-R26E
AMC 433153	ROCKSTAR 754	2015-4418				SEC20-T06S-R26E
AMC 433154	ROCKSTAR 755	2015-4419				SEC20-T06S-R26E
AMC 433155	ROCKSTAR 756	2015-4420				SEC20-T06S-R26E
AMC 433156	ROCKSTAR 757	2015-4421				SEC20-T06S-R26E
AMC 433157	ROCKSTAR 758	2015-4422				SEC20-T06S-R26E

Date: 6/1/2017

RECEIVED  
 BLM AZ STATE OFFICE  
 2017 JUL 12 A 10:49  
 PHOENIX, ARIZONA

## Exhibit A

County: Graham

State: AZ

BLM Serial #	Claim Name	Original Recording		Amended Recording		Location
		Recording #	Page #	Recording #	Page #	
AMC 433158	ROCKSTAR 759	2015-4423				SEC20-T06S-R26E
AMC 433159	ROCKSTAR 760	2015-4424				SEC20-T06S-R26E
AMC 433160	ROCKSTAR 761	2015-4425				SEC20-T06S-R26E
AMC 433161	ROCKSTAR 762	2015-4426				SEC20-T06S-R26E
AMC 433162	ROCKSTAR 763	2015-4427				SEC20-T06S-R26E
AMC 433163	ROCKSTAR 764	2015-4428				SEC20-T06S-R26E
AMC 433164	ROCKSTAR 765	2015-4429				SEC20-T06S-R26E
AMC 433165	ROCKSTAR 766	2015-4430				SEC20-T06S-R26E
AMC 433166	ROCKSTAR 767	2015-4431				SEC20-T06S-R26E
AMC 433167	ROCKSTAR 768	2015-4432				SEC20-T06S-R26E
AMC 433168	ROCKSTAR 769	2015-4433				SEC20-T06S-R26E
AMC 433169	ROCKSTAR 770	2015-4434				SEC20-T06S-R26E
AMC 433170	ROCKSTAR 771	2015-4435				SEC20-T06S-R26E
AMC 433171	ROCKSTAR 772	2015-4436				SEC20-T06S-R26E
AMC 433172	ROCKSTAR 773	2015-4437				SEC20-T06S-R26E
AMC 433173	ROCKSTAR 774	2015-4438				SEC20-T06S-R26E
AMC 433174	ROCKSTAR 775	2015-4439				SEC20-T06S-R26E
AMC 433175	ROCKSTAR 776	2015-4440				SEC20-T06S-R26E
AMC 433176	ROCKSTAR 777	2015-4441				SEC20-T06S-R26E
AMC 433177	ROCKSTAR 778	2015-4442				SEC20-T06S-R26E
AMC 433178	ROCKSTAR 779	2015-4443				SEC20-T06S-R26E
AMC 433179	ROCKSTAR 780	2015-4444				SEC20-T06S-R26E
AMC 433180	ROCKSTAR 781	2015-4445				SEC20-T06S-R26E
AMC 433181	ROCKSTAR 782	2015-4446				SEC20-T06S-R26E
AMC 433182	ROCKSTAR 783	2015-4447				SEC20-T06S-R26E
AMC 433183	ROCKSTAR 784	2015-4448				SEC20-T06S-R26E
AMC 433184	ROCKSTAR 785	2015-4449				SEC20-T06S-R26E
AMC 433185	ROCKSTAR 786	2015-4450				SEC20-T06S-R26E
AMC 433186	ROCKSTAR 787	2015-4451				SEC20-T06S-R26E
AMC 433187	ROCKSTAR 788	2015-4452				SEC20-T06S-R26E
AMC 433188	ROCKSTAR 789	2015-4453				SEC20-T06S-R26E
AMC 433189	ROCKSTAR 790	2015-4454				SEC21-T06S-R26E
AMC 433190	ROCKSTAR 791	2015-4455				SEC21-T06S-R26E
AMC 433191	ROCKSTAR 792	2015-4456				SEC21-T06S-R26E
AMC 433192	ROCKSTAR 793	2015-4457				SEC21-T06S-R26E
AMC 433193	ROCKSTAR 794	2015-4458				SEC21-T06S-R26E
AMC 433194	ROCKSTAR 795	2015-4459				SEC21-T06S-R26E
AMC 433195	ROCKSTAR 796	2015-4460				SEC21-T06S-R26E

Date: 6/1/2017

RECEIVED  
BLM AZ STATE OFFICE  
JUL 12 A 10:49  
PHOENIX, ARIZONA

## Exhibit A

County: Graham

State: AZ

<u>BLM Serial #</u>	<u>Claim Name</u>	<u>Original Recording</u>		<u>Amended Recording</u>		<u>Location</u>
		<u>Recording #</u>	<u>Page #</u>	<u>Recording #</u>	<u>Page #</u>	
AMC 433196	ROCKSTAR 797	2015-4461				SEC21-T06S-R26E
AMC 433197	ROCKSTAR 798	2015-4462				SEC21-T06S-R26E
AMC 433198	ROCKSTAR 799	2015-4463				SEC21-T06S-R26E
AMC 433199	ROCKSTAR 800	2015-4464				SEC21-T06S-R26E
AMC 433200	ROCKSTAR 801	2015-4465				SEC21-T06S-R26E
AMC 433201	ROCKSTAR 802	2015-4466				SEC21-T06S-R26E
AMC 433202	ROCKSTAR 803	2015-4467				SEC21-T06S-R26E
AMC 433203	ROCKSTAR 804	2015-4468				SEC21-T06S-R26E
AMC 433204	ROCKSTAR 805	2015-4469				SEC21-T06S-R26E
AMC 433205	ROCKSTAR 806	2015-4470				SEC21-T06S-R26E
AMC 433206	ROCKSTAR 807	2015-4471				SEC21-T06S-R26E
AMC 433207	ROCKSTAR 808	2015-4472				SEC21-T06S-R26E
AMC 433208	ROCKSTAR 809	2015-4473				SEC21-T06S-R26E
AMC 433209	ROCKSTAR 810	2015-4474				SEC21-T06S-R26E
AMC 433210	ROCKSTAR 811	2015-4475				SEC21-T06S-R26E
AMC 433211	ROCKSTAR 812	2015-4476				SEC21-T06S-R26E
AMC 433212	ROCKSTAR 813	2015-4477				SEC21-T06S-R26E
AMC 433213	ROCKSTAR 814	2015-4478				SEC21-T06S-R26E
AMC 433214	ROCKSTAR 815	2015-4479				SEC21-T06S-R26E
AMC 433215	ROCKSTAR 816	2015-4480				SEC21-T06S-R26E
AMC 433216	ROCKSTAR 817	2015-4481				SEC21-T06S-R26E
AMC 433217	ROCKSTAR 818	2015-4482				SEC21-T06S-R26E
AMC 433218	ROCKSTAR 819	2015-4483				SEC21-T06S-R26E
AMC 433219	ROCKSTAR 820	2015-4484				SEC21-T06S-R26E
AMC 433220	ROCKSTAR 821	2015-4485				SEC21-T06S-R26E
AMC 433221	ROCKSTAR 822	2015-4486				SEC21-T06S-R26E
AMC 433222	ROCKSTAR 823	2015-4487				SEC21-T06S-R26E
AMC 433223	ROCKSTAR 824	2015-4488				SEC21-T06S-R26E
AMC 433224	ROCKSTAR 825	2015-4489				SEC21-T06S-R26E
AMC 433225	ROCKSTAR 826	2015-4490				SEC22-T06S-R26E
AMC 433226	ROCKSTAR 827	2015-4491				SEC22-T06S-R26E
AMC 433227	ROCKSTAR 828	2015-4492				SEC22-T06S-R26E
AMC 433228	ROCKSTAR 829	2015-4493				SEC22-T06S-R26E
AMC 433229	ROCKSTAR 830	2015-4494				SEC22-T06S-R26E
AMC 433230	ROCKSTAR 831	2015-4495				SEC22-T06S-R26E
AMC 433231	ROCKSTAR 832	2015-4496				SEC22-T06S-R26E
AMC 433232	ROCKSTAR 833	2015-4497				SEC22-T06S-R26E
AMC 433233	ROCKSTAR 834	2015-4498				SEC22-T06S-R26E

Date: 6/1/2017

RECEIVED  
BLM AZ STATE OFFICE  
2017 JUL 12 A 10 49  
PHOENIX, ARIZONA

## Exhibit A

County: Graham

State: AZ

BLM Serial #	Claim Name	Original Recording		Amended Recording		Location
		Recording #	Page #	Recording #	Page #	
AMC 433234	ROCKSTAR 835	2015-4499				SEC22-T06S-R26E
AMC 433235	ROCKSTAR 836	2015-4500				SEC22-T06S-R26E
AMC 433236	ROCKSTAR 837	2015-4501				SEC22-T06S-R26E
AMC 433237	ROCKSTAR 838	2015-4502				SEC22-T06S-R26E
AMC 433238	ROCKSTAR 839	2015-4503				SEC22-T06S-R26E
AMC 433239	ROCKSTAR 840	2015-4504				SEC22-T06S-R26E
AMC 433240	ROCKSTAR 841	2015-4505				SEC22-T06S-R26E
AMC 433241	ROCKSTAR 842	2015-4506				SEC22-T06S-R26E
AMC 433242	ROCKSTAR 843	2015-4507				SEC22-T06S-R26E
AMC 433243	ROCKSTAR 844	2015-4508				SEC22-T06S-R26E
AMC 433244	ROCKSTAR 845	2015-4509				SEC22-T06S-R26E
AMC 433245	ROCKSTAR 846	2015-4510				SEC22-T06S-R26E
AMC 433246	ROCKSTAR 847	2015-4511				SEC22-T06S-R26E
AMC 433247	ROCKSTAR 848	2015-4512				SEC22-T06S-R26E
AMC 433248	ROCKSTAR 849	2015-4513				SEC22-T06S-R26E
AMC 433249	ROCKSTAR 850	2015-4514				SEC22-T06S-R26E
AMC 433250	ROCKSTAR 851	2015-4515				SEC22-T06S-R26E
AMC 433251	ROCKSTAR 852	2015-4516				SEC22-T06S-R26E
AMC 433252	ROCKSTAR 853	2015-4517				SEC22-T06S-R26E
AMC 433253	ROCKSTAR 854	2015-4518				SEC22-T06S-R26E
AMC 433254	ROCKSTAR 855	2015-4519				SEC22-T06S-R26E
AMC 433255	ROCKSTAR 856	2015-4520				SEC22-T06S-R26E
AMC 433256	ROCKSTAR 857	2015-4521				SEC22-T06S-R26E
AMC 433257	ROCKSTAR 858	2015-4522				SEC22-T06S-R26E
AMC 433258	ROCKSTAR 859	2015-4523				SEC22-T06S-R26E
AMC 433259	ROCKSTAR 860	2015-4524				SEC22-T06S-R26E
AMC 433260	ROCKSTAR 861	2015-4525				SEC22-T06S-R26E
AMC 433261	ROCKSTAR 862	2015-4526				SEC27-T06S-R26E
AMC 433262	ROCKSTAR 863	2015-4527				SEC27-T06S-R26E
AMC 433263	ROCKSTAR 864	2015-4528				SEC27-T06S-R26E
AMC 433264	ROCKSTAR 865	2015-4529				SEC27-T06S-R26E
AMC 433265	ROCKSTAR 866	2015-4530				SEC27-T06S-R26E
AMC 433266	ROCKSTAR 867	2015-4531				SEC27-T06S-R26E
AMC 433267	ROCKSTAR 868	2015-4532				SEC27-T06S-R26E
AMC 433268	ROCKSTAR 869	2015-4533				SEC27-T06S-R26E
AMC 433269	ROCKSTAR 870	2015-4534				SEC27-T06S-R26E
AMC 433270	ROCKSTAR 871	2015-4535				SEC27-T06S-R26E
AMC 433271	ROCKSTAR 872	2015-4536				SEC27-T06S-R26E

Date: 6/1/2017

RECEIVED  
BLM AZ STATE OFFICE  
JUL 12 2017 10:49  
PHOENIX, ARIZONA

## Exhibit A

County: Graham

State: AZ

BLM Serial #	Claim Name	Original Recording		Amended Recording		Location
		Recording #	Page #	Recording #	Page #	
AMC 433272	ROCKSTAR 873	2015-4537				SEC27-T06S-R26E
AMC 433273	ROCKSTAR 874	2015-4538				SEC27-T06S-R26E
AMC 433274	ROCKSTAR 875	2015-4539				SEC27-T06S-R26E
AMC 433275	ROCKSTAR 876	2015-4540				SEC27-T06S-R26E
AMC 433276	ROCKSTAR 877	2015-4541				SEC27-T06S-R26E
AMC 433277	ROCKSTAR 878	2015-4542				SEC27-T06S-R26E
AMC 433278	ROCKSTAR 879	2015-4543				SEC27-T06S-R26E
AMC 433279	ROCKSTAR 880	2015-4544				SEC27-T06S-R26E
AMC 433280	ROCKSTAR 881	2015-4545				SEC27-T06S-R26E
AMC 433281	ROCKSTAR 882	2015-4546				SEC28-T06S-R26E
AMC 433282	ROCKSTAR 883	2015-4547				SEC28-T06S-R26E
AMC 433283	ROCKSTAR 884	2015-4548				SEC28-T06S-R26E
AMC 433284	ROCKSTAR 885	2015-4549				SEC28-T06S-R26E
AMC 433285	ROCKSTAR 886	2015-4550				SEC28-T06S-R26E
AMC 433286	ROCKSTAR 887	2015-4551				SEC28-T06S-R26E
AMC 433287	ROCKSTAR 888	2015-4552				SEC28-T06S-R26E
AMC 433288	ROCKSTAR 889	2015-4553				SEC28-T06S-R26E
AMC 433289	ROCKSTAR 890	2015-4554				SEC28-T06S-R26E
AMC 433290	ROCKSTAR 891	2015-4555				SEC28-T06S-R26E
AMC 433291	ROCKSTAR 892	2015-4556				SEC28-T06S-R26E
AMC 433292	ROCKSTAR 893	2015-4557				SEC28-T06S-R26E
AMC 433293	ROCKSTAR 894	2015-4558				SEC28-T06S-R26E
AMC 433294	ROCKSTAR 895	2015-4559				SEC28-T06S-R26E
AMC 433295	ROCKSTAR 896	2015-4560				SEC28-T06S-R26E
AMC 433296	ROCKSTAR 897	2015-4561				SEC28-T06S-R26E
AMC 433297	ROCKSTAR 898	2015-4562				SEC28-T06S-R26E
AMC 433298	ROCKSTAR 899	2015-4563				SEC28-T06S-R26E
AMC 433299	ROCKSTAR 900	2015-4564				SEC28-T06S-R26E
AMC 433300	ROCKSTAR 901	2015-4565				SEC28-T06S-R26E
AMC 433301	ROCKSTAR 902	2015-4566				SEC28-T06S-R26E
AMC 433302	ROCKSTAR 903	2015-4567				SEC28-T06S-R26E
AMC 433303	ROCKSTAR 904	2015-4568				SEC28-T06S-R26E
AMC 433304	ROCKSTAR 905	2015-4569				SEC28-T06S-R26E
AMC 433305	ROCKSTAR 906	2015-4570				SEC28-T06S-R26E
AMC 433306	ROCKSTAR 907	2015-4571				SEC28-T06S-R26E
AMC 433307	ROCKSTAR 908	2015-4572				SEC28-T06S-R26E
AMC 433308	ROCKSTAR 909	2015-4573				SEC28-T06S-R26E
AMC 433309	ROCKSTAR 910	2015-4574				SEC28-T06S-R26E

Date: 6/1/2017

RECEIVED  
BLM AZ STATE OFFICE  
2017 JUL 12 A 10:49  
PHOENIX, ARIZONA

## Exhibit A

County: Graham

State: AZ

Original Recording

Amended Recording

<u>BLM Serial #</u>	<u>Claim Name</u>	<u>Recording #</u>	<u>Page #</u>	<u>Recording #</u>	<u>Page #</u>	<u>Location</u>
AMC 433310	ROCKSTAR 911	2015-4575				SEC29-T06S-R26E
AMC 433311	ROCKSTAR 912	2015-4576				SEC29-T06S-R26E
AMC 433312	ROCKSTAR 913	2015-4577				SEC29-T06S-R26E
AMC 433313	ROCKSTAR 914	2015-4578				SEC29-T06S-R26E
AMC 433314	ROCKSTAR 915	2015-4579				SEC29-T06S-R26E
AMC 433315	ROCKSTAR 916	2015-4580				SEC29-T06S-R26E
AMC 433316	ROCKSTAR 917	2015-4581				SEC29-T06S-R26E
AMC 433317	ROCKSTAR 918	2015-4582				SEC29-T06S-R26E
AMC 433318	ROCKSTAR 919	2015-4583				SEC29-T06S-R26E
AMC 433319	ROCKSTAR 920	2015-4584				SEC29-T06S-R26E
AMC 433320	ROCKSTAR 921	2015-4585				SEC29-T06S-R26E
AMC 433321	ROCKSTAR 922	2015-4586				SEC29-T06S-R26E
AMC 433322	ROCKSTAR 923	2015-4587				SEC29-T06S-R26E
AMC 433323	ROCKSTAR 924	2015-4588				SEC29-T06S-R26E
AMC 433324	ROCKSTAR 925	2015-4589				SEC29-T06S-R26E
AMC 433325	ROCKSTAR 926	2015-4590				SEC29-T06S-R26E
AMC 433326	ROCKSTAR 927	2015-4591				SEC29-T06S-R26E
AMC 433327	ROCKSTAR 928	2015-4592				SEC29-T06S-R26E
AMC 433328	ROCKSTAR 929	2015-4593				SEC30-T06S-R26E
AMC 433329	ROCKSTAR 930	2015-4594				SEC30-T06S-R26E
AMC 433330	ROCKSTAR 931	2015-4595		2017-00416		SEC30-T06S-R26E
AMC 433331	ROCKSTAR 932	2015-4596		2017-00417		SEC30-T06S-R26E
AMC 433332	ROCKSTAR 933	2015-4597		2017-00418		SEC30-T06S-R26E
AMC 433333	ROCKSTAR 934	2015-4598		2017-00419		SEC30-T06S-R26E
AMC 433334	ROCKSTAR 935	2015-4599		2017-00420		SEC30-T06S-R26E
AMC 433335	ROCKSTAR 936	2015-4600		2017-00421		SEC30-T06S-R26E
AMC 433336	ROCKSTAR 937	2015-4601		2017-00422		SEC30-T06S-R26E
AMC 433337	ROCKSTAR 938	2015-4602		2017-00423		SEC31-T06S-R26E
AMC 433338	ROCKSTAR 939	2015-4603				SEC30-T06S-R26E
AMC 433339	ROCKSTAR 940	2015-4604				SEC30-T06S-R26E
AMC 433340	ROCKSTAR 941	2015-4605				SEC30-T06S-R26E
AMC 433341	ROCKSTAR 942	2015-4606				SEC30-T06S-R26E
AMC 433342	ROCKSTAR 943	2015-4607				SEC30-T06S-R26E
AMC 433343	ROCKSTAR 944	2015-4608		2017-00424		SEC30-T06S-R26E
AMC 433344	ROCKSTAR 945	2015-4609				SEC30-T06S-R26E
AMC 433345	ROCKSTAR 946	2015-4610				SEC30-T06S-R26E
AMC 433346	ROCKSTAR 947	2015-4611				SEC30-T06S-R26E
AMC 433347	ROCKSTAR 948	2015-4612				SEC30-T06S-R26E

Date: 6/1/2017

RECEIVED  
BLM AZ STATE OFFICE  
2017 JUL 12 A 10:49  
PHOENIX, ARIZONA

## Exhibit A

County: Graham

State: AZ

BLM Serial #	Claim Name	Original Recording		Amended Recording		Location
		Recording #	Page #	Recording #	Page #	
AMC 433348	ROCKSTAR 949	2015-4613		2017-00588		SEC30-T06S-R26E
AMC 433349	ROCKSTAR 950	2015-4614				SEC30-T06S-R26E
AMC 433350	ROCKSTAR 951	2015-4615				SEC30-T06S-R26E
AMC 433351	ROCKSTAR 952	2015-4616				SEC30-T06S-R26E
AMC 433352	ROCKSTAR 953	2015-4617				SEC30-T06S-R26E
AMC 433353	ROCKSTAR 954	2015-4618				SEC30-T06S-R26E
AMC 433354	ROCKSTAR 955	2015-4619		2017-00426		SEC31-T06S-R26E
AMC 433355	ROCKSTAR 956	2015-4620				SEC31-T06S-R26E
AMC 433356	ROCKSTAR 957	2015-4621				SEC31-T06S-R26E
AMC 433357	ROCKSTAR 958	2015-4622				SEC32-T06S-R26E
AMC 433358	ROCKSTAR 959	2015-4623				SEC32-T06S-R26E
AMC 433359	ROCKSTAR 960	2015-4624				SEC31-T06S-R26E
AMC 433360	ROCKSTAR 961	2015-4625				SEC31-T06S-R26E
AMC 433361	ROCKSTAR 962	2015-4626				SEC31-T06S-R26E
AMC 433362	ROCKSTAR 963	2015-4627				SEC31-T06S-R26E
AMC 433363	ROCKSTAR 964	2015-4628				SEC31-T06S-R26E
AMC 433364	ROCKSTAR 965	2015-4629				SEC31-T06S-R26E
AMC 433365	ROCKSTAR 966	2015-4630				SEC31-T06S-R26E
AMC 433366	ROCKSTAR 967	2015-4631				SEC31-T06S-R26E
AMC 433367	ROCKSTAR 968	2015-4632				SEC31-T06S-R26E
AMC 433368	ROCKSTAR 969	2015-4633				SEC31-T06S-R26E
AMC 433369	ROCKSTAR 970	2015-4634				SEC31-T06S-R26E
AMC 433370	ROCKSTAR 971	2015-4635				SEC31-T06S-R26E
AMC 433371	ROCKSTAR 973	2015-4636				SEC31-T06S-R26E
AMC 433372	ROCKSTAR 974	2015-4637				SEC32-T06S-R26E
AMC 433373	ROCKSTAR 975	2015-4638				SEC31-T06S-R26E
AMC 433374	ROCKSTAR 976	2015-4639				SEC31-T06S-R26E
AMC 433375	ROCKSTAR 977	2015-4640				SEC32-T06S-R26E
AMC 433376	ROCKSTAR 978	2015-4641				SEC32-T06S-R26E
AMC 433377	ROCKSTAR 979	2015-4642				SEC32-T06S-R26E
AMC 433378	ROCKSTAR 980	2015-4643				SEC32-T06S-R26E
AMC 433379	ROCKSTAR 981	2015-4644				SEC32-T06S-R26E
AMC 433380	ROCKSTAR 982	2015-4645				SEC32-T06S-R26E
AMC 433381	ROCKSTAR 983	2015-4646				SEC32-T06S-R26E
AMC 433382	ROCKSTAR 984	2015-4647				SEC32-T06S-R26E
AMC 433383	ROCKSTAR 985	2015-4648				SEC32-T06S-R26E
AMC 433384	ROCKSTAR 986	2015-4649				SEC32-T06S-R26E
AMC 433385	ROCKSTAR 987	2015-4650				SEC32-T06S-R26E

Date: 6/1/2017

RECEIVED  
 BLM AZ STATE OFFICE  
 2017 JUL 12 A 10 49  
 PHOENIX, ARIZONA



## Exhibit A

County: Graham

State: AZ

Original Recording

Amended Recording

<u>BLM Serial #</u>	<u>Claim Name</u>	<u>Recording #</u>	<u>Page #</u>	<u>Recording #</u>	<u>Page #</u>	<u>Location</u>
AMC 433386 7	ROCKSTAR 988	2015-4651				SEC32-T06S-R26E
AMC 433387	ROCKSTAR 989	2015-4652				SEC32-T06S-R26E
AMC 433388	ROCKSTAR 990	2015-4653				SEC32-T06S-R26E
AMC 433389	ROCKSTAR 991	2015-4654				SEC33-T06S-R26E
AMC 433390	ROCKSTAR 992	2015-4655				SEC33-T06S-R26E
AMC 433391	ROCKSTAR 993	2015-4656				SEC33-T06S-R26E
AMC 433392	ROCKSTAR 994	2015-4657				SEC33-T06S-R26E
AMC 433393	ROCKSTAR 995	2015-4658				SEC33-T06S-R26E
AMC 433394	ROCKSTAR 996	2015-4659				SEC33-T06S-R26E
AMC 433395	ROCKSTAR 997	2015-4660				SEC33-T06S-R26E
AMC 433396	ROCKSTAR 998	2015-4661				SEC33-T06S-R26E
AMC 433397	ROCKSTAR 999	2015-4662				SEC33-T06S-R26E
AMC 433398	ROCKSTAR 1000	2015-4663				SEC33-T06S-R26E
AMC 433399	ROCKSTAR 1001	2015-4664				SEC33-T06S-R26E
AMC 433400	ROCKSTAR 1002	2015-4665				SEC33-T06S-R26E
AMC 433401	ROCKSTAR 1003	2015-4666				SEC32-T06S-R26E
AMC 433402	ROCKSTAR 1004	2015-4667				SEC32-T06S-R26E
AMC 433403	ROCKSTAR 1005	2015-4668				SEC32-T06S-R26E
AMC 433404	ROCKSTAR 1006	2015-4669				SEC33-T06S-R26E
AMC 433405	ROCKSTAR 1007	2015-4670				SEC33-T06S-R26E
AMC 433406 )	ROCKSTAR 1008	2015-4671				SEC28-T06S-R26E
AMC 433439 7	Red Bull-681	2015-4746				SEC22-T05S-R26E
AMC 433440	Red Bull-682	2015-4747				SEC22-T05S-R26E
AMC 433441	Red Bull-683	2015-4748				SEC22-T05S-R26E
AMC 433442	Red Bull-684	2015-4749				SEC22-T05S-R26E
AMC 433443	Red Bull-685	2015-4750				SEC22-T05S-R26E
AMC 433444	Red Bull-686	2015-4751				SEC22-T05S-R26E
AMC 433448	Red Bull-690	2015-4755				SEC22-T05S-R26E
AMC 433449	Red Bull-691	2015-4756				SEC22-T05S-R26E
AMC 433450	Red Bull-692	2015-4757				SEC22-T05S-R26E
AMC 433451	Red Bull-693	2015-4758				SEC22-T05S-R26E
AMC 433452	Red Bull-694	2015-4759				SEC22-T05S-R26E
AMC 433453 )	Red Bull-695	2015-4760				SEC22-T05S-R26E
AMC 433457 7	Red Bull-699	2015-4764				SEC09-T05S-R26E
AMC 433458 )	Red Bull-700	2015-4765				SEC09-T05S-R26E
AMC 433469 7	Red Bull-711	2015-4776				SEC09-T05S-R26E
AMC 433470	Red Bull-712	2015-4777				SEC09-T05S-R26E
AMC 433471	Red Bull-713	2015-4778				SEC09-T05S-R26E

Date: 6/1/2017

RECEIVED  
BLM AZ STATE OFFICE  
2017 JUL 12 A 10 50  
PHOENIX, ARIZONA

## Exhibit A

County: Graham

State: AZ

<u>BLM Serial #</u>	<u>Claim Name</u>	<u>Original Recording</u>		<u>Amended Recording</u>		<u>Location</u>
		<u>Recording #</u>	<u>Page #</u>	<u>Recording #</u>	<u>Page #</u>	
AMC 433472	Red Bull-714	2015-4779				SEC09-T05S-R26E
AMC 433473	Red Bull-715	2015-4780				SEC09-T05S-R26E
AMC 433474	Red Bull-716	2015-4781				SEC09-T05S-R26E
AMC 433475	Red Bull-717	2015-4782				SEC09-T05S-R26E
AMC 433476	Red Bull-718	2015-4783				SEC09-T05S-R26E
AMC 433477	Red Bull-719	2015-4784				SEC09-T05S-R26E
AMC 433478	Red Bull-720	2015-4785				SEC09-T05S-R26E
AMC 433479	Red Bull-721	2015-4786				SEC09-T05S-R26E
AMC 433480	Red Bull-722	2015-4787				SEC09-T05S-R26E
AMC 433481	Red Bull-723	2015-4788				SEC09-T05S-R26E
AMC 433482	Red Bull-724	2015-4789				SEC09-T05S-R26E
AMC 433483	Red Bull-725	2015-4790				SEC09-T05S-R26E
AMC 433484	Red Bull-726	2015-4791				SEC09-T05S-R26E
AMC 433485	Red Bull-727	2015-4792				SEC09-T05S-R26E
AMC 433486	Red Bull-728	2015-4793				SEC09-T05S-R26E
AMC 433487	Red Bull-729	2015-4794				SEC09-T05S-R26E
AMC 433488	Red Bull-730	2015-4795				SEC09-T05S-R26E
AMC 433489	Red Bull-731	2015-4796				SEC09-T05S-R26E
AMC 433490	Red Bull-732	2015-4797				SEC09-T05S-R26E
AMC 433491	Red Bull-733	2015-4798				SEC09-T05S-R26E
AMC 433492	Red Bull-734	2015-4799				SEC04-T05S-R26E
AMC 433493	Red Bull-735	2015-4800				SEC04-T05S-R26E
AMC 433494	Red Bull-736	2015-4801				SEC04-T05S-R26E
AMC 433495	Red Bull-737	2015-4802				SEC05-T05S-R26E
AMC 433496	Red Bull-738	2015-4803				SEC05-T05S-R26E
AMC 433497	Red Bull-739	2015-4804				SEC05-T05S-R26E
AMC 441072	ROCKSTAR 931B	2017-00427				SEC30-T06S-R26E
AMC 441073	ROCKSTAR 937A	2017-00428				SEC31-T06S-R26E
AMC 441074	ROCKSTAR 931A	2017-00429				SEC30-T06S-R26E
AMC 441075	ROCKSTAR 932B	2017-00430				SEC30-T06S-R26E
AMC 441076	ROCKSTAR 933B	2017-00431				SEC30-T06S-R26E
AMC 441077	ROCKSTAR 934B	2017-00432				SEC30-T06S-R26E
AMC 441078	ROCKSTAR 935B	2017-00433				SEC30-T06S-R26E
AMC 441079	ROCKSTAR 936B	2017-00434				SEC30-T06S-R26E
AMC 441080	ROCKSTAR 937B	2017-00435				SEC30-T06S-R26E
AMC 441081	ROCKSTAR 938B	2017-00436				SEC30-T06S-R26E
AMC 441082	ROCKSTAR 944B	2017-00437				SEC30-T06S-R26E
AMC 441083	ROCKSTAR 949B	2017-00438				SEC30-T06S-R26E

Date: 6/1/2017

RECEIVED  
 BLM AZ STATE OFFICE  
 JUL 12 10:50 AM  
 PHOENIX, ARIZONA

## Exhibit A

County: Graham

State: AZ

Original Recording

Amended Recording

<u>BLM Serial #</u>	<u>Claim Name</u>	<u>Recording #</u>	<u>Page #</u>	<u>Recording #</u>	<u>Page #</u>	<u>Location</u>
AMC 441084	ROCKSTAR 955B	2017-00439				SEC30-T06S-R26E
AMC 78650	Melody #1	77	472			SEC11-T06S-R26E
AMC 78651	Melody #5	77	474			SEC11-T06S-R26E
AMC 78652	Melody #7	77	475			SEC11-T06S-R26E
AMC 78653	Melody #9	77	476			SEC11-T06S-R26E
AMC 78654	Melody #11	77	477			SEC11-T06S-R26E
AMC 78655	Melody #8	77	490			SEC11-T06S-R26E
AMC 78656	Melody #10	77	491			SEC11-T06S-R26E
AMC 78657	Melody #18	77	495			SEC14-T06S-R26E
AMC 78658	Melody #20	77	496			SEC14-T06S-R26E
AMC 78659	Melody #13	77	478			SEC11-T06S-R26E
AMC 78660	Melody #17	77	480			SEC14-T06S-R26E
AMC 78661	Melody #19	77	481			SEC14-T06S-R26E
AMC 78662	Melody #21	77	482			SEC14-T06S-R26E
AMC 78663	Melody #23	77	483			SEC14-T06S-R26E
AMC 78664	Melody #27	77	485			SEC14-T06S-R26E
AMC 78665	Melody #29	77	486			SEC14-T06S-R26E
AMC 78666	Melody #31	257	540			SEC14-T06S-R26E
AMC 78667	Melody #32	257	541			SEC14-T06S-R26E
AMC 78668	Melody #16	77	494			SEC11-T06S-R26E
AMC 78669	Melody #3	77	473			SEC11-T06S-R26E
AMC 78670	Melody #15	77	479			SEC11-T06S-R26E
AMC 78671	Melody #25	77	484			SEC14-T06S-R26E
<b>No. Of Claims</b>	3557					

23

RECEIVED  
 BLM AZ STATE OFFICE  
 2017 JUL 12 A 10:50  
 PHOENIX, ARIZONA

**United States Department of the Interior**  
**Bureau of Land Management**  
 DIV OF LANDS, MINRLS & ENERGY  
 ONE N CENTRAL AVE  
 PHOENIX, AZ 85004 -4427  
 Phone: 602-417-9200

Receipt

No: 3886169

<b>Transaction #:</b> 3995370	
<b>Date of Transaction:</b> 07/12/2017	
<b>CUSTOMER:</b>	
FREEPORT MCMORAN INC 333 N CENTRAL AVE PHOENIX, AZ 85004-2121 US	

LINE #	QTY	DESCRIPTION	REMARKS	UNIT PRICE	TOTAL
1	1.00	LOCATABLE MINERALS / MINING CLAIMS- NOT NEW-UNADJUD, ONE AUTH NO. ONLY / MINING CLAIM MONEY RECEIVED <b>CASES: AMC46122/\$551335.00</b>	MAINT 2018/3557	- n/a -	551335.00
<b>TOTAL:</b>					<b>\$551,335.00</b>

PAYMENT INFORMATION					
1	AMOUNT:	551335.00	POSTMARKED:	N/A	
	TYPE:	CHECK	RECEIVED:	07/12/2017	
	CHECK NO:	879336			
	NAME:	FREEPORT MCMORAN INC 333 N CENTRAL AVE PHOENIX AZ 85004-2121 US			

REMARKS

This receipt was generated by the automated BLM Collections and Billing System and is a paper representation of a portion of the official electronic record contained therein.

August 2, 2016

After recording, return to:  
Freeport-McMoRan  
Attn: C. Loder  
333 North Central Avenue  
Phoenix, AZ 85004

Bureau of Land Management  
Department of the Interior  
One N. Central Avenue  
Phoenix, AZ 85004

46122	298929	340956	432241
47901	305755	341652	432443
66892	321860	344109	432486
78466	324229	430691	432621
101235	324366	430751	432994
113312	324842	430889	433439
288506	326065	431071	
289500	326786	431121	
292727	329064	431317	
293492	329094	431566	
294150	330967	431611	
294346	331727	431791	
298849	333390	431904	
298861	334772	432120	
	340495		

RECEIVED  
BLM AZ STATE OFFICE  
2016 AUG - 3 A 9: 18  
PHOENIX, ARIZONA

2016

**NOTICE OF INTENT TO HOLD MINING CLAIMS AND PAYMENT OF BLM MAINTENANCE FEE**

Re: Payment of Annual Claim Maintenance Fee

Dear Sir or Madam:

This will serve as notice that Freeport Minerals Corporation, whose address for purposes of this filing is Land and Water Department, 333 North Central Ave., Phoenix, Arizona 85004, intends to hold the mining claims and/or mill sites described on Exhibit A attached hereto for the assessment year ending at 12 o'clock, noon, on September 1, 2017 by payment of the annual maintenance fee of \$155 per claim or site. Payment of such amount is made herewith for such assessment year for each of the claims and sites, the name, and BLM serial number with the book and page or index number of recording of the location notice in the official records of Graham County, Arizona, of which, is set forth on Exhibit A attached hereto and by this reference incorporated herein.

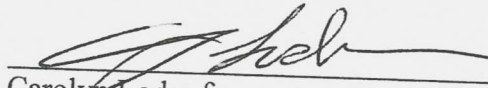
  
\_\_\_\_\_  
Carolyn Loder for  
Freeport Minerals Corporation

State of Arizona        )  
                                  ) ss.  
County of Maricopa    )

The foregoing instrument was acknowledged before me on August 2<sup>nd</sup>, 2016, by Carolyn Loder, on behalf of Freeport Minerals Coporation.

(Seal)

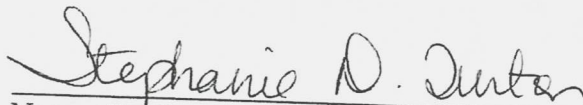

  
\_\_\_\_\_  
Stephanie D. Turton  
Notary Public  
My commission expires: 11-18-2019

## EXHIBIT A

County: Graham

State: AZ

BLM Serial #	Claim Name	Original Recording		Amended Recording		Location
		Recording #	Page #	Recording #	Page #	
AMC 046122	GEM 1	210	420			
AMC 046123	GEM 2	210	421			SEC26-T06S-R27E
AMC 046124	GEM 3	210	422			SEC35-T06S-R27E
AMC 046125	GEM 4	210	423			SEC35-T06S-R27E
AMC 046126	GEM 5	210	424			SEC35-T06S-R27E
AMC 046127	GEM 6	210	425			SEC35-T06S-R27E
AMC 046131	GEM 10	210	429	531	520	SEC35-T06S-R27E
AMC 046132	GEM 11	210	430			SEC26-T06S-R27E
AMC 046133	GEM 12	210	431			SEC26-T06S-R27E
AMC 046134	GEM 13	210	432			SEC35-T06S-R27E
AMC 046135	GEM 14	210	433			SEC35-T06S-R27E
AMC 046136	GEM 15	210	434			SEC35-T06S-R27E
AMC 046137	GEM 16	210	435			SEC35-T06S-R27E
AMC 046138	GEM 17	210	436			SEC35-T06S-R27E
AMC 046139	GEM 18	210	437			SEC35-T06S-R27E
AMC 046140	GEM 19	210	438			SEC35-T06S-R27E
AMC 046141	GEM 20	210	439			SEC35-T06S-R27E
AMC 046142	GEM 21	210	440			SEC26-T06S-R27E
AMC 046143	GEM 22	210	441			SEC26-T06S-R27E
AMC 046144	GEM 23	210	442			SEC26-T06S-R27E
AMC 046145	GEM 24	210	443			SEC26-T06S-R27E
AMC 046146	GEM 25	210	444			SEC26-T06S-R27E
AMC 046147	GEM 26	210	445			SEC26-T06S-R27E
AMC 046148	GEM 27	210	446			SEC26-T06S-R27E
AMC 046149	GEM 28	210	447			SEC26-T06S-R27E
AMC 046150	GEM 29	210	448			SEC26-T06S-R27E
AMC 046151	GEM 30	210	449			SEC26-T06S-R27E
AMC 046152	GEM 31	210	450			SEC26-T06S-R27E
AMC 046153	GEM 32	210	451			SEC26-T06S-R27E
AMC 046154	GEM 33	210	452			SEC26-T06S-R27E
AMC 046171	GEM 50	210	469			SEC26-T06S-R27E
AMC 046172	GEM 51	210	470			SEC26-T06S-R27E
AMC 046173	GEM 52	210	471			SEC26-T06S-R27E
AMC 046174	GEM 53	210	472			SEC26-T06S-R27E
AMC 046175	GEM 54	210	473			SEC26-T06S-R27E
AMC 046176	GEM 55	210				SEC26-T06S-R27E
AMC 046177	GEM 56	210				SEC26-T06S-R27E
AMC 046203	GEM 82	210	475			SEC26-T06S-R27E
		210	501			SEC26-T06S-R27E

Date: 7/25/2016

RECEIVED  
BLM AZ STATE OFFICE  
2016 AUG - 3 A 9 19  
PHOENIX, ARIZONA

## EXHIBIT A

County: Graham

State: AZ

<u>BLM Serial #</u>	<u>Claim Name</u>	<u>Original Recording</u>		<u>Amended Recording</u>		<u>Location</u>
		<u>Recording #</u>	<u>Page #</u>	<u>Recording #</u>	<u>Page #</u>	
AMC 046204	GEM 83	210	502			SEC26-T06S-R27E
AMC 046205	GEM 84	210	503			SEC26-T06S-R27E
AMC 046206	GEM 85	210	504			SEC26-T06S-R27E
AMC 046207	GEM 86	210	505			SEC26-T06S-R27E
AMC 046208	GEM 87	210	506			SEC26-T06S-R27E
AMC 046209	GEM 88	210	507			SEC26-T06S-R27E
AMC 046210	GEM 89	210	508			SEC26-T06S-R27E
AMC 046211	GEM 90	210	509			SEC26-T06S-R27E
AMC 046212	GEM 91	210	510			SEC26-T06S-R27E
AMC 046213	GEM 92	210	511			SEC26-T06S-R27E
AMC 046214	GEM 93	210	512			SEC26-T06S-R27E
AMC 046215	GEM 94	210	513			SEC26-T06S-R27E
AMC 046216	GEM 95	210	514			SEC26-T06S-R27E
AMC 046217	GEM 96	210	515			SEC26-T06S-R27E
AMC 046218	GEM 97	210	516			SEC26-T06S-R27E
AMC 046219	GEM 98	210	517			SEC26-T06S-R27E
AMC 046220	GEM 99	210	518			SEC26-T06S-R27E
AMC 046221	GEM 100	210	519			SEC26-T06S-R27E
AMC 046222	GEM 101	210	520			SEC26-T06S-R27E
AMC 046223	GEM 102	210	521			SEC26-T06S-R27E
AMC 046224	GEM 103	210	522			SEC26-T06S-R27E
AMC 046225	GEM 104	210	523			SEC26-T06S-R27E
AMC 046226	GEM 105	210	524			SEC26-T06S-R27E
AMC 046227	GEM 106	210	525			SEC26-T06S-R27E
AMC 046228	GEM 107	210	526			SEC26-T06S-R27E
AMC 046229	GEM 108	210	527			SEC26-T06S-R27E
AMC 046230	GEM 109	210	528			SEC26-T06S-R27E
AMC 046231	GEM 110	210	529			SEC26-T06S-R27E
AMC 046232	GEM 111	210	530			SEC26-T06S-R27E
AMC 046233	GEM 112	210	531			SEC26-T06S-R27E
AMC 046234	GEM 113	210	532			SEC23-T06S-R27E
AMC 046235	GEM 114	210	533			SEC23-T06S-R27E
AMC 046236	GEM 115	210	534			SEC23-T06S-R27E
AMC 046237	GEM 116	210	535			SEC23-T06S-R27E
AMC 046238	GEM 117	210	536			SEC25-T06S-R27E
AMC 046239	GEM 118	210				SEC25-T06S-R27E
AMC 046240	GEM 119	210	538			SEC25-T06S-R27E
AMC 046241	GEM 120	210	539			SEC25-T06S-R27E

Date: 7/25/2016

RECEIVED  
BLM AZ STATE OFFICE  
2016 AUG - 3 A 9 19  
PHOENIX, ARIZONA

## EXHIBIT A

County: Graham

State: AZ

<u>BLM Serial #</u>	<u>Claim Name</u>	<u>Original Recording</u>		<u>Amended Recording</u>		<u>Location</u>
		<u>Recording #</u>	<u>Page #</u>	<u>Recording #</u>	<u>Page #</u>	
AMC 046242	GEM 121	210	540			SEC25-T06S-R27E
AMC 046243	GEM 122	210	541			SEC25-T06S-R27E
AMC 046244	GEM 123	210	542			SEC25-T06S-R27E
AMC 046245	GEM 124	210	543			SEC25-T06S-R27E
AMC 046246	GEM 125	210	544			SEC25-T06S-R27E
AMC 046247	GEM 126	210	545			SEC25-T06S-R27E
AMC 046248	GEM 127	210	546			SEC25-T06S-R27E
AMC 046249	GEM 128	210	547			SEC25-T06S-R27E
AMC 046250	GEM 129	210	548			SEC25-T06S-R27E
AMC 046251	GEM 130	210	549			SEC25-T06S-R27E
AMC 046252	GEM 131	210	550			SEC25-T06S-R27E
AMC 046253	GEM 132	210	551			SEC25-T06S-R27E
AMC 046254	GEM 133	210	552			SEC25-T06S-R27E
AMC 046255	GEM 134	210	553			SEC25-T06S-R27E
AMC 046256	GEM 135	210	554			SEC25-T06S-R27E
AMC 046257	GEM 136	210	555			SEC25-T06S-R27E
AMC 046258	GEM 137	210	556			SEC25-T06S-R27E
AMC 046259	GEM 138	210	557			SEC25-T06S-R27E
AMC 046260	GEM 139	210	558			SEC25-T06S-R27E
AMC 046261	GEM 140	210	559			SEC25-T06S-R27E
AMC 046262	GEM 141	210	560			SEC25-T06S-R27E
AMC 046263	GEM 142	210	561			SEC25-T06S-R27E
AMC 046264	GEM 143	210	562			SEC25-T06S-R27E
AMC 046265	GEM 144	210	563			SEC25-T06S-R27E
AMC 046266	GEM 145	210	564			SEC25-T06S-R27E
AMC 046267	GEM 146	210	565			SEC25-T06S-R27E
AMC 046268	GEM 147	210	566			SEC25-T06S-R27E
AMC 046269	GEM 148	210	567			SEC25-T06S-R27E
AMC 046270	GEM 149	210	568			SEC25-T06S-R27E
AMC 046271	GEM 150	210	569			SEC25-T06S-R27E
AMC 046272	GEM 151	210	570			SEC25-T06S-R27E
AMC 046273	GEM 152	210	571			SEC25-T06S-R27E
AMC 046274	GEM 153	210	572			SEC25-T06S-R27E
AMC 046275	GEM 154	210	573			SEC25-T06S-R27E
AMC 046276	GEM 155	210	574			SEC25-T06S-R27E
AMC 046277	GEM 156	210	574			SEC25-T06S-R27E
AMC 046278	GEM 157	210	576			SEC25-T06S-R27E
AMC 046279	GEM 158	210	576			SEC25-T06S-R27E

Date: 7/25/2016

RECEIVED  
 BLM AZ STATE OFFICE  
 2016 AUG - 3 A 9 19  
 PHOENIX, ARIZONA



## EXHIBIT A

County: Graham

State: AZ

<u>BLM Serial #</u>	<u>Claim Name</u>	<u>Original Recording</u>		<u>Amended Recording</u>		<u>Location</u>
		<u>Recording #</u>	<u>Page #</u>	<u>Recording #</u>	<u>Page #</u>	
AMC 046280	GEM 159	210	578			SEC25-T06S-R27E
AMC 046281	GEM 160	210	579			SEC25-T06S-R27E
AMC 046282	GEM 161	210	580			SEC25-T06S-R27E
AMC 046283	GEM 162	210	581			SEC25-T06S-R27E
AMC 046284	GEM 163	210	582			SEC25-T06S-R27E
AMC 046285	GEM 164	210	583			SEC25-T06S-R27E
AMC 046286	GEM 165	210	584			SEC25-T06S-R27E
AMC 046287	GEM 166	210	585			SEC25-T06S-R27E
AMC 046288	GEM 167	210	586			SEC25-T06S-R27E
AMC 046289	GEM 168	210	587			SEC25-T06S-R27E
AMC 046290	GEM 169	210	588			SEC25-T06S-R27E
AMC 046291	GEM 170	210	589			SEC25-T06S-R27E
AMC 046292	GEM 171	210	590			SEC25-T06S-R27E
AMC 046293	GEM 172	210	591			SEC25-T06S-R27E
AMC 046294	GEM 173	210	592			SEC25-T06S-R27E
AMC 046295	GEM 174	210	593			SEC25-T06S-R27E
AMC 046296	GEM 175	210	594			SEC30-T06S-R28E
AMC 046297	GEM 176	210	595			SEC30-T06S-R28E
AMC 046298	GEM 177	210	596			SEC25-T06S-R27E
AMC 046299	GEM 178	210	597			SEC25-T06S-R27E
AMC 046300	GEM 179	210	598			SEC25-T06S-R27E
AMC 046301	GEM 180	210	599			SEC25-T06S-R27E
AMC 046302	GEM 181	210	600			SEC25-T06S-R27E
AMC 046303	GEM 182	211	1			SEC25-T06S-R27E
AMC 046304	GEM 183	211	2			SEC25-T06S-R27E
AMC 046305	GEM 184	211	3			SEC25-T06S-R27E
AMC 046306	GEM 185	211	4			SEC25-T06S-R27E
AMC 046307	GEM 186	211	5			SEC25-T06S-R27E
AMC 046308	GEM 187	211	6			SEC25-T06S-R27E
AMC 046309	GEM 188	211	7			SEC25-T06S-R27E
AMC 046310	GEM 189	211	8			SEC25-T06S-R27E
AMC 046311	GEM 190	211	9			SEC25-T06S-R27E
AMC 046312	GEM 191	211	10			SEC25-T06S-R27E
AMC 046313	GEM 192	211	11			SEC25-T06S-R27E
AMC 046314	GEM 193	211	12			SEC25-T06S-R27E
AMC 046315	GEM 194	211	13			SEC25-T06S-R27E
AMC 046316	GEM 195	211	14			SEC25-T06S-R27E
AMC 046317	GEM 196	211	15			SEC25-T06S-R27E

Date: 7/25/2016

RECEIVED  
 BLM AZ STATE OFFICE  
 PHOENIX, ARIZONA  
 2016 AUG - 3 9 19

## EXHIBIT A

County: Graham

State: AZ

<u>BLM Serial #</u>	<u>Claim Name</u>	<u>Original Recording</u>		<u>Amended Recording</u>		<u>Location</u>
		<u>Recording #</u>	<u>Page #</u>	<u>Recording #</u>	<u>Page #</u>	
AMC 046318	GEM 197	211	16			SEC25-T06S-R27E
AMC 046319	GEM 198	211	17			SEC25-T06S-R27E
AMC 046320	GEM 199	211	18			SEC25-T06S-R27E
AMC 046321	GEM 200	211	19			SEC25-T06S-R27E
AMC 046322	GEM 201	211	20			SEC25-T06S-R27E
AMC 046323	GEM 202	211	21			SEC30-T06S-R28E
AMC 046324	GEM 203	211	22			SEC30-T06S-R28E
AMC 046328	GEM 207	211	26			SEC30-T06S-R28E
AMC 046329	GEM 208	211	27			SEC25-T06S-R27E
AMC 046330	GEM 209	211	28			SEC25-T06S-R27E
AMC 046331	GEM 210	211	29			SEC25-T06S-R27E
AMC 046332	GEM 211	211	30			SEC25-T06S-R27E
AMC 046333	GEM 212	211	31			SEC25-T06S-R27E
AMC 046334	GEM 213	211	32			SEC25-T06S-R27E
AMC 046335	GEM 214	211	33			SEC25-T06S-R27E
AMC 046336	GEM 215	211	34			SEC25-T06S-R27E
AMC 046337	GEM 216	211	35			SEC25-T06S-R27E
AMC 046338	GEM 217	211	36			SEC25-T06S-R27E
AMC 046339	GEM 218	211	37			SEC25-T06S-R27E
AMC 046340	GEM 219	211	38			SEC24-T06S-R27E
AMC 046341	GEM 220	211	39			SEC24-T06S-R27E
AMC 046342	GEM 221	211	40			SEC24-T06S-R27E
AMC 046343	GEM 222	211	41			SEC24-T06S-R27E
AMC 046344	GEM 223	211	42			SEC24-T06S-R27E
AMC 046345	GEM 224	211	43			SEC19-T06S-R28E
AMC 046352	GEM 231	211	50			SEC19-T06S-R28E
AMC 046353	GEM 232	211	51			SEC24-T06S-R27E
AMC 046354	GEM 233	211	52			SEC24-T06S-R27E
AMC 046355	GEM 234	211	53			SEC24-T06S-R27E
AMC 046356	GEM 235	211	54			SEC24-T06S-R27E
AMC 046380	Basalt No. 7	92	624	519	13	SEC26-T06S-R27E
AMC 046381	Basalt No. 8	92	625	519	15	SEC26-T06S-R27E
AMC 046382	Basalt No. 9	92	626	519	17	SEC26-T06S-R27E
AMC 046383	Basalt No. 10	92	656	519	19	SEC35-T06S-R27E
AMC 046388	Basalt No. 17	92	689	519	21	SEC25-T06S-R27E
AMC 046391	Basalt No. 21	98	139			SEC25-T06S-R27E
AMC 046392	Basalt No. 24	98	140	519	23	SEC25-T06S-R27E
AMC 046393	Basalt No. 28	98	141	519	25	SEC25-T06S-R27E

Date: 7/25/2016

RECEIVED  
BLM AZ STATE OFFICE

PHOENIX, ARIZONA  
2016 AUG - 3 A 9 18

## EXHIBIT A

County: Graham

State: AZ

BLM Serial #	Claim Name	Original Recording		Amended Recording		Location
		Recording #	Page #	Recording #	Page #	
AMC 046468	Jerico	82	548	531	522	SEC35-T06S-R27E
AMC 046469	Jerico No. 2	82	549	519	45	SEC35-T06S-R27E
AMC 047907	Shasta No. 1	39	396			SEC26-T06S-R27E
AMC 047908	Shasta No. 2	39	397			SEC26-T06S-R27E
AMC 047909	Shasta No. 3	39	398	519	57	SEC26-T06S-R27E
AMC 047910	Shasta No. 4	39	399	519	59	SEC26-T06S-R27E
AMC 047913	Fox No. 3	36	506	519	27	SEC26-T06S-R27E
AMC 047914	Fox No. 4	36	507	519	29	SEC26-T06S-R27E
AMC 047915	Fox No. 5	36	508	519	31	SEC26-T06S-R27E
AMC 047916	Fox No. 6	36	509	519	33	SEC25-T06S-R27E
AMC 047917	Fox No. 7	36	510	519	35	SEC25-T06S-R27E
AMC 047920	Fox No. 18	75	625	519	37	SEC26-T06S-R27E
AMC 047921	Fox No. 19	75	626	519	39	SEC26-T06S-R27E
AMC 047922	Fox No. 20	75	627	519	41	SEC26-T06S-R27E
AMC 047923	Pat No. 3	39	404	519	47	SEC26-T06S-R27E
AMC 047924	Pat No. 4	39	405			SEC26-T06S-R27E
AMC 047926	Pat No. 6	89	674	519	49	SEC25-T06S-R27E
AMC 047927	Pat No. 7	89	675	519	51	SEC25-T06S-R27E
AMC 047928	Pat No. 8	89	676	519	53	SEC25-T06S-R27E
AMC 047929	Pat No. 9	89	677	519	55	SEC25-T06S-R27E
AMC 047930	AI No. 1	39	384	519	9	SEC26-T06S-R27E
AMC 047931	AI No. 2	39	385	519	11	SEC26-T06S-R27E
AMC 067551	Senorbac 24A	44	433	415	301	SEC31-T05S-R27E
AMC 067557	Senorbac 30A	44	439	415	317	SEC31-T05S-R27E
AMC 067558	Senorbac 31A	44	440	415	329	SEC31-T05S-R27E
AMC 067561	Senorbac 35A	44	443	415	333	SEC31-T05S-R27E
AMC 067596	A-1A	41	242	410	469	SEC12-T06S-R26E
AMC 067615	Bush 32A	53	386	414	21	SEC14-T06S-R26E
AMC 067616	Bush 33A	53	387	414	23	SEC14-T06S-R26E
AMC 067617	Bush 34A	53	388	414	25	SEC14-T06S-R26E
AMC 067618	Bush 35A	53	389	414	27	SEC14-T06S-R26E
AMC 067619	Bush 36A	53	390	414	29	SEC14-T06S-R26E
AMC 067633	Con. Metals No. 20A	31	597	410	451	SEC12-T06S-R26E
AMC 067634	Coors A	41	241	410	471	SEC12-T06S-R26E
AMC 067637	Griesdieck A	45	5	410	473	SEC12-T06S-R26E
AMC 067642	Ithaca No. 20A	41	235	410	461	SEC12-T06S-R26E
AMC 067655	Pabst A	41	240	414	37	SEC14-T06S-R26E
AMC 067656	Schlitz A		246	414	35	SEC14-T06S-R26E

Date: 7/25/2016

Page 6

RECEIVED  
BLM AZ STATE OFFICE  
PHOENIX, ARIZONA  
AUG - 3 - 2016

## EXHIBIT A

County: Graham

State: AZ

BLM Serial #	Claim Name	Original Recording		Amended Recording		Location
		Recording #	Page #	Recording #	Page #	
AMC 067657	Mas No. 9	249	269			SEC27-T06S-R26E
AMC 067658	Mas No. 10	249	270			SEC27-T06S-R26E
AMC 067659	Mas No. 11	249	271			SEC27-T06S-R26E
AMC 067660	Mas No. 12	249	272			SEC27-T06S-R26E
AMC 067661	Mas No. 13	249	273			SEC27-T06S-R26E
AMC 067662	Mas No. 14	249	274			SEC27-T06S-R26E
AMC 067663	Mas No. 15	249	275			SEC27-T06S-R26E
AMC 067664	Mas No. 16	249	276			SEC27-T06S-R26E
AMC 067665	Mas No. 17	249	277			SEC27-T06S-R26E
AMC 067666	Mas No. 18	249	278			SEC27-T06S-R26E
AMC 067667	Mas No. 19	249	279			SEC34-T06S-R26E
AMC 067668	Mas No. 20	249	280			SEC34-T06S-R26E
AMC 067669	Mas No. 21	249	281			SEC34-T06S-R26E
AMC 067670	Mas No. 22	249	282			SEC34-T06S-R26E
AMC 067671	Mas No. 23	249	283			SEC34-T06S-R26E
AMC 067672	Mas No. 24	249	284			SEC34-T06S-R26E
AMC 067673	Mas No. 25	249	285			SEC34-T06S-R26E
AMC 067674	Mas No. 26	249	286			SEC34-T06S-R26E
AMC 067675	Mas No. 27	249	287			SEC34-T06S-R26E
AMC 067676	Mas No. 28	249	288			SEC34-T06S-R26E
AMC 067677	Mas No. 29	249	289			SEC34-T06S-R26E
AMC 067678	Mas No. 30	249	290			SEC34-T06S-R26E
AMC 067679	Mas No. 31	249	291			SEC34-T06S-R26E
AMC 067680	Mas No. 32	249	292			SEC34-T06S-R26E
AMC 067681	Mas No. 33	249	293			SEC34-T06S-R26E
AMC 067682	Mas No. 34	249	294			SEC34-T06S-R26E
AMC 067683	Mas No. 35	249	295			SEC34-T06S-R26E
AMC 067684	Mas No. 36	249	296			SEC34-T06S-R26E
AMC 067685	Mas No. 45	249	297			SEC27-T06S-R26E
AMC 067686	Mas No. 46	249	298			SEC27-T06S-R26E
AMC 067687	Mas No. 47	249	299			SEC27-T06S-R26E
AMC 067688	Mas No. 48	249	300			SEC27-T06S-R26E
AMC 067689	Mas No. 49	249	301			SEC27-T06S-R26E
AMC 067690	Mas No. 50	249	302			SEC27-T06S-R26E
AMC 067691	Mas No. 51	249	303			SEC27-T06S-R26E
AMC 067692	Mas No. 52	249	304			SEC27-T06S-R26E
AMC 067693	Mas No. 53	249	305			SEC27-T06S-R26E
AMC 067694	Mas No. 54	249	306			SEC27-T06S-R26E

Date: 7/25/2016

Page 7

RECEIVED  
BLM AZ STATE OFFICE  
2016 AUG - 3 A 9 20  
PHOENIX, ARIZONA

## EXHIBIT A

County: Graham

State: AZ

<u>BLM Serial #</u>	<u>Claim Name</u>	<u>Original Recording</u>		<u>Amended Recording</u>		<u>Location</u>
		<u>Recording #</u>	<u>Page #</u>	<u>Recording #</u>	<u>Page #</u>	
AMC 067695	Mas No. 55	249	307			SEC27-T06S-R26E
AMC 067696	Mas No. 56	249	308			SEC27-T06S-R26E
AMC 067697	Mas No. 57	249	309			SEC27-T06S-R26E
AMC 067698	Mas No. 58	249	310			SEC27-T06S-R26E
AMC 067699	Mas No. 59	249	311			SEC27-T06S-R26E
AMC 067700	Mas No. 60	249	312			SEC27-T06S-R26E
AMC 067701	Mas No. 61	249	313			SEC27-T06S-R26E
AMC 067702	Mas No. 62	249	314			SEC27-T06S-R26E
AMC 067703	Mas No. 63	249	315			SEC27-T06S-R26E
AMC 067704	Mas No. 64	249	316			SEC27-T06S-R26E
AMC 067705	Mas No. 65	249	317			SEC27-T06S-R26E
AMC 067706	Mas No. 66	249	318			SEC27-T06S-R26E
AMC 067707	Mas No. 67	249	319			SEC27-T06S-R26E
AMC 067708	Mas No. 68	249	320			SEC27-T06S-R26E
AMC 067709	Mas No. 69	249	321			SEC27-T06S-R26E
AMC 067710	Mas No. 70	249	322			SEC27-T06S-R26E
AMC 067711	Mas No. 71	249	323			SEC27-T06S-R26E
AMC 067712	Mas No. 72	249	324			SEC34-T06S-R26E
AMC 067713	Mas No. 73	249	325			SEC28-T06S-R26E
AMC 067714	Mas No. 74	249	326			SEC28-T06S-R26E
AMC 067715	Mas No. 75	249	327			SEC28-T06S-R26E
AMC 067716	Mas No. 76	249	328			SEC28-T06S-R26E
AMC 067717	Mas No. 77	249	329			SEC28-T06S-R26E
AMC 067718	Mas No. 78	249	330			SEC28-T06S-R26E
AMC 067719	Mas No. 79	249	331			SEC28-T06S-R26E
AMC 067720	Mas No. 80	249	332			SEC28-T06S-R26E
AMC 067721	Mas No. 81	249	333			SEC28-T06S-R26E
AMC 067722	Mas No. 82	249	334			SEC28-T06S-R26E
AMC 067723	Mas No. 83	249	335			SEC33-T06S-R26E
AMC 067724	Mas No. 84	249	336			SEC33-T06S-R26E
AMC 067725	Mas No. 85	249	337			SEC33-T06S-R26E
AMC 067726	Mas No. 86	249	338			SEC33-T06S-R26E
AMC 067727	Mas No. 87	249	339			SEC33-T06S-R26E
AMC 067728	Mas No. 88	249	340			SEC33-T06S-R26E
AMC 067729	Mas No. 89	249	341			SEC33-T06S-R26E
AMC 067730	Mas No. 90	249	342			SEC33-T06S-R26E
AMC 067731	Mas No. 91	249	343			SEC33-T06S-R26E
AMC 067732	Mas No. 92	249	344			SEC33-T06S-R26E

Date: 7/25/2016

Page 8

RECEIVED  
BLM AZ STATE OFFICE

2016 AUG - 3 A 9 20

PHOENIX, ARIZONA

## EXHIBIT A

County: Graham

State: AZ

BLM Serial #	Claim Name	Original Recording		Amended Recording		
		Recording #	Page #	Recording #	Page #	Location
AMC 067733	Mas No. 93	249	345			SEC33-T06S-R26E
AMC 067734	Mas No. 94	249	346			SEC33-T06S-R26E
AMC 067735	Mas No. 96	249	348			SEC33-T06S-R26E
AMC 067736	Mas No. 98	249	349			SEC33-T06S-R26E
AMC 067737	Mas No. 100	249	350			SEC33-T06S-R26E
AMC 067750	Epsilon No. 51	51	38			SEC09-T06S-R27E
AMC 067767	Garoga 16A	46	61	416	972	SEC10-T06S-R27E
AMC 067772	Garoga #21	46	56			SEC10-T06S-R27E
AMC 067773	Garoga #22	46	55			SEC10-T06S-R27E
AMC 067774	Garoga #23	46	54			SEC10-T06S-R27E
AMC 067775	Garoga #24	46	53			SEC10-T06S-R27E
AMC 067776	Garoga #25	46	52			SEC10-T06S-R27E
AMC 067829	Alpha 61A	46	22	420	29	SEC20-T06S-R27E
AMC 067831	Alpha 63A	46	24	420	33	SEC20-T06S-R27E
AMC 067833	Alpha 65A	46	26	420	37	SEC20-T06S-R27E
AMC 067835	Alpha 67A	46	28	420	41	SEC20-T06S-R27E
AMC 067837	Alpha #69	46	30			SEC20-T06S-R27E
AMC 067839	Alpha #71	46	32			SEC20-T06S-R27E
AMC 067841	Alpha #73	46	34			SEC20-T06S-R27E
AMC 101253	Ace 19A	324	272	414	31	SEC14-T06S-R26E
AMC 101254	Ace 20A	324	274	414	33	SEC14-T06S-R26E
AMC 101282	Ace 48A	324	330	410	397	SEC11-T06S-R26E
AMC 101283	Ace 49A	324	332	410	399	SEC11-T06S-R26E
AMC 101284	Ace 50A	324	334	410	401	SEC11-T06S-R26E
AMC 101285	Ace 51A	324	336	478	241	SEC11-T06S-R26E
AMC 101286	Ace 52A	324	338	478	243	SEC11-T06S-R26E
AMC 113312	Melody #2A	332	595			SEC11-T06S-R26E
AMC 113313	Melody #4A	332	596			SEC11-T06S-R26E
AMC 113314	Melody #6A	332	597			SEC11-T06S-R26E
AMC 113315	Melody #12A	332	598			SEC11-T06S-R26E
AMC 113316	Melody #14A	332	599			SEC11-T06S-R26E
AMC 113317	Melody #22A	332	600			SEC11-T06S-R26E
AMC 113318	Melody #24A	332	601			SEC11-T06S-R26E
AMC 113319	Melody #26A	332	602			SEC11-T06S-R26E
AMC 113320	Melody #28A	332	603			SEC11-T06S-R26E
AMC 113321	Melody #30A	332	604			SEC11-T06S-R26E
AMC 288506	GEM 252	409	77			SEC36-T06S-R27E
AMC 288507	GEM 253	409	79			SEC36-T06S-R27E

Date: 7/25/2016

Page 9

RECEIVED  
 BLM AZ STATE OFFICE  
 2016 AUG - 3 A 9 20  
 PHOENIX, ARIZONA

## EXHIBIT A

County: Graham

State: AZ

<u>BLM Serial #</u>	<u>Claim Name</u>	<u>Original Recording</u>		<u>Amended Recording</u>		<u>Location</u>
		<u>Recording #</u>	<u>Page #</u>	<u>Recording #</u>	<u>Page #</u>	
AMC 288508	GEM 254	409	80			SEC36-T06S-R27E
AMC 288509	GEM 255	409	81			SEC36-T06S-R27E
AMC 288510	GEM 256	409	82			SEC36-T06S-R27E
AMC 288511	GEM 257	409	83			SEC36-T06S-R27E
AMC 288512	GEM 258	409	84			SEC36-T06S-R27E
AMC 288513	GEM 259	409	85			SEC36-T06S-R27E
AMC 288514	GEM 260	409	86			SEC36-T06S-R27E
AMC 288515	GEM 261	409	87			SEC36-T06S-R27E
AMC 288516	GEM 262	409	88			SEC36-T06S-R27E
AMC 288517	GEM 263	409	89			SEC36-T06S-R27E
AMC 288518	GEM 264	409	90			SEC36-T06S-R27E
AMC 288519	GEM 265	409	91			SEC36-T06S-R27E
AMC 288520	GEM 266	409	92			SEC36-T06S-R27E
AMC 288521	GEM 267	409	93			SEC36-T06S-R27E
AMC 288522	GEM 268	409	94			SEC36-T06S-R27E
AMC 288523	GEM 269	409	95			SEC36-T06S-R27E
AMC 288524	GEM 270	409	96			SEC36-T06S-R27E
AMC 288525	GEM 271	409	97			SEC36-T06S-R27E
AMC 288526	GEM 272	409	98			SEC36-T06S-R27E
AMC 288527	GEM 273	409	99			SEC36-T06S-R27E
AMC 288528	GEM 274	409	100			SEC36-T06S-R27E
AMC 288529	GEM 275	409	101			SEC36-T06S-R27E
AMC 289500	LS-21	410	379			SEC14-T06S-R26E
AMC 289501	LS-22	410	381			SEC11-T06S-R26E
AMC 292727	AZCO #1 Amended	413	128	512	669	SEC33-T06S-R27E
AMC 292728	AZCO #2 Amended	413	130	512	671	SEC04-T07S-R27E
AMC 292729	AZCO #3 Amended	413	132	512	673	SEC33-T06S-R27E
AMC 292730	AZCO #4 Amended	413	134	512	675	SEC04-T07S-R27E
AMC 292731	AZCO #5 Amended	413	136	512	677	SEC33-T06S-R27E
AMC 292732	AZCO #6 Amended	413	138	512	679	SEC04-T07S-R27E
AMC 292733	AZCO #7 Amended	413	140	512	681	SEC33-T06S-R27E
AMC 292734	AZCO #8 Amended	413	142	512	683	SEC04-T07S-R27E
AMC 292735	AZCO #9 Amended	413	144	512	685	SEC33-T06S-R27E
AMC 292736	AZCO #10 Amended	413	146	512	687	SEC04-T07S-R27E
AMC 292737	AZCO #11 Amended	413	148	512	689	SEC33-T06S-R27E
AMC 292738	AZCO #12 Amended	413	150	512	691	SEC04-T07S-R27E
AMC 292739	AZCO #13 Amended	413	152	512	693	SEC33-T06S-R27E
AMC 292740	AZCO #14 Amended	413	154	512	695	SEC04-T07S-R27E

Date: 7/25/2016

RECEIVED  
BLM AZ STATE OFFICE

## EXHIBIT A

County: Graham

State: AZ

<u>BLM Serial #</u>	<u>Claim Name</u>	<u>Original Recording</u>		<u>Amended Recording</u>		
		<u>Recording #</u>	<u>Page #</u>	<u>Recording #</u>	<u>Page #</u>	<u>Location</u>
AMC 292741	AZCO #15 Amended	413	156	512	697	SEC33-T06S-R27E
AMC 292742	AZCO #16 Amended	413	158	512	699	SEC04-T07S-R27E
AMC 292743	AZCO #17 Amended	413	160	512	701	SEC33-T06S-R27E
AMC 292744	AZCO #18 Amended	413	162	512	703	SEC04-T07S-R27E
AMC 292759	AZCO #33 Amended	413	192	512	705	SEC33-T06S-R27E
AMC 292760	AZCO #34 Amended	413	194	512	707	SEC33-T06S-R27E
AMC 292761	AZCO #35 Amended	413	196	512	709	SEC33-T06S-R27E
AMC 292762	AZCO #36 Amended	413	198	512	711	SEC33-T06S-R27E
AMC 292763	AZCO #37 Amended	413	200	512	713	SEC33-T06S-R27E
AMC 292764	AZCO #38 Amended	413	202	512	715	SEC33-T06S-R27E
AMC 292765	AZCO #100 Amended	413	204	512	731	SEC33-T06S-R27E
AMC 292766	AZCO #101 Amended	413	206	512	733	SEC33-T06S-R27E
AMC 292767	AZCO #102 Amended	413	208	512	735	SEC33-T06S-R27E
AMC 292768	AZCO #103 Amended	413	210	512	737	SEC33-T06S-R27E
AMC 292769	AZCO #104 Amended	413	212	512	739	SEC33-T06S-R27E
AMC 292770	AZCO #105 Amended	413	214	512	741	SEC33-T06S-R27E
AMC 292771	AZCO #106 Amended	413	216	512	743	SEC33-T06S-R27E
AMC 292772	AZCO #107 Amended	413	218	512	745	SEC33-T06S-R27E
AMC 292773	AZCO #108 Amended	413	220	512	747	SEC33-T06S-R27E
AMC 292774	AZCO #109 Amended	413	222	512	749	SEC33-T06S-R27E
AMC 292775	AZCO #110 Amended	413	224	512	751	SEC33-T06S-R27E
AMC 292776	AZCO #111 Amended	413	226	512	753	SEC33-T06S-R27E
AMC 292777	AZCO #112 Amended	413	228	512	755	SEC33-T06S-R27E
AMC 292778	AZCO #113 Amended	413	230	512	757	SEC33-T06S-R27E
AMC 292791	AZCO #126 Amended	413	256	512	759	SEC27-T06S-R27E
AMC 292792	AZCO #127 Amended	413	258	512	761	SEC27-T06S-R27E
AMC 292793	AZCO #128 Amended	413	260	512	763	SEC34-T06S-R27E
AMC 292794	AZCO #129 Amended	413	262	512	765	SEC34-T06S-R27E
AMC 292795	AZCO #130 Amended	413	264	512	767	SEC34-T06S-R27E
AMC 292796	AZCO #131 Amended	413	266	512	769	SEC34-T06S-R27E
AMC 292797	AZCO #132 Amended	413	268	512	771	SEC34-T06S-R27E
AMC 292798	AZCO #133 Amended	413	270	512	773	SEC34-T06S-R27E
AMC 292799	AZCO #134 Amended	413	272	512	775	SEC34-T06S-R27E
AMC 292800	AZCO #135 Amended	413	274	512	777	SEC34-T06S-R27E
AMC 292801	AZCO #136 Amended	413	276	512	779	SEC34-T06S-R27E
AMC 292802	AZCO #137 Amended	413	278	512	781	SEC34-T06S-R27E
AMC 292803	AZCO #138 Amended	413	280	512	783	SEC34-T06S-R27E
AMC 292804	AZCO #139 Amended	413	282	512	785	SEC34-T06S-R27E

Date: 7/25/2016

RECEIVED  
BLM AZ STATE OFFICE



## EXHIBIT A

County: Graham

State: AZ

<u>BLM Serial #</u>	<u>Claim Name</u>	<u>Original Recording</u>		<u>Amended Recording</u>		
		<u>Recording #</u>	<u>Page #</u>	<u>Recording #</u>	<u>Page #</u>	<u>Location</u>
AMC 292809	AZCO #144 Amended	413	292	512	787	SEC34-T06S-R27E
AMC 292810	AZCO #145 Amended	413	294	512	789	SEC34-T06S-R27E
AMC 292811	AZCO #146 Amended	413	296	512	791	SEC34-T06S-R27E
AMC 292812	AZCO #147 Amended	413	298	512	793	SEC34-T06S-R27E
AMC 292820	AZCO #155 Amended	413	314	512	795	SEC28-T06S-R27E
AMC 292822	AZCO #157 Amended	413	318	512	797	SEC28-T06S-R27E
AMC 292824	AZCO #159 Amended	413	322	512	799	SEC28-T06S-R27E
AMC 292826	AZCO #161 Amended	413	326	512	801	SEC28-T06S-R27E
AMC 292828	AZCO #163 Amended	413	330	512	803	SEC27-T06S-R27E
AMC 292829	AZCO #164 Amended	413	332	512	805	SEC27-T06S-R27E
AMC 292830	AZCO #165 Amended	413	334	512	807	SEC27-T06S-R27E
AMC 292831	AZCO #166 Amended	413	336	512	809	SEC27-T06S-R27E
AMC 292832	AZCO #167 Amended	413	338	512	811	SEC27-T06S-R27E
AMC 292833	AZCO #168 Amended	413	340	512	813	SEC27-T06S-R27E
AMC 292834	AZCO #169 Amended	413	342	512	815	SEC27-T06S-R27E
AMC 292835	AZCO #170 Amended	413	344	512	817	SEC27-T06S-R27E
AMC 292836	AZCO #171 Amended	413	346	512	819	SEC27-T06S-R27E
AMC 292837	AZCO #172 Amended	413	348	512	821	SEC27-T06S-R27E
AMC 292838	AZCO #173 Amended	413	350	512	823	SEC27-T06S-R27E
AMC 292839	AZCO #174 Amended	413	352	512	825	SEC27-T06S-R27E
AMC 292840	AZCO #175 Amended	413	354	512	827	SEC27-T06S-R27E
AMC 292841	AZCO #176 Amended	413	356	512	829	SEC27-T06S-R27E
AMC 292842	AZCO #177 Amended	413	358	512	831	SEC27-T06S-R27E
AMC 292843	AZCO #178 Amended	413	360	512	833	SEC27-T06S-R27E
AMC 292844	AZCO #179 Amended	413	362	512	835	SEC27-T06S-R27E
AMC 292845	AZCO #180 Amended	413	364	512	837	SEC26-T06S-R27E
AMC 292846	AZCO #181 Amended	413	366	512	839	SEC26-T06S-R27E
AMC 292847	AZCO #182 Amended	413	368	512	841	SEC26-T06S-R27E
AMC 292848	AZCO #183 Amended	413	370	512	843	SEC26-T06S-R27E
AMC 292850	AZCO #195 Amended	413	374	512	857	SEC27-T06S-R27E
AMC 292851	AZCO #196 Amended	413	376	512	859	SEC26-T06S-R27E
AMC 292852	AZCO #197 Amended	413	378	512	861	SEC26-T06S-R27E
AMC 292853	AZCO #198 Amended	413	380	512	863	SEC26-T06S-R27E
AMC 292856	AZCO #202 Amended	413	386	512	865	SEC35-T06S-R27E
AMC 293498	LS-36	414	51			SEC14-T06S-R26E
AMC 294150	AZCO #39 Amended	415	9	512	717	SEC33-T06S-R27E
AMC 294151	AZCO #40 Amended	415	11	512	719	SEC33-T06S-R27E
AMC 294152	AZCO #41 Amended	415	13	512	721	SEC33-T06S-R27E

Date: 7/25/2016

Page 12

RECEIVED  
 BLM AZ STATE OFFICE  
 2016 AUG - 3 A 9:20  
 PHOENIX, ARIZONA

## EXHIBIT A

County: Graham

State: AZ

BLM Serial #	Claim Name	Original Recording		Amended Recording		
		Recording #	Page #	Recording #	Page #	Location
AMC 294153	AZCO #42 Amended	415	15	512	723	SEC33-T06S-R27E
AMC 294154	AZCO #43 Amended	415	17	512	725	SEC28-T06S-R27E
AMC 294155	AZCO #203 Amended	415	19	512	867	SEC28-T06S-R27E
AMC 294157	AZCO #205 Amended	415	23	512	869	SEC28-T06S-R27E
AMC 294159	AZCO #207 Amended	415	27	512	871	SEC28-T06S-R27E
AMC 294161	AZCO #209 Amended	415	31	512	873	SEC28-T06S-R27E
AMC 294167	AZCO #357 Amended	415	135	512	889	SEC24-T06S-R27E
AMC 294168	AZCO #359 Amended	415	137	512	893	SEC24-T06S-R27E
AMC 294169	AZCO #361 Amended	415	139	512	897	SEC24-T06S-R27E
AMC 294170	AZCO #363 Amended	415	141	512	901	SEC24-T06S-R27E
AMC 294171	AZCO #364 Amended	415	143	512	903	SEC24-T06S-R27E
AMC 294172	AZCO #365 Amended	415	145	512	905	SEC24-T06S-R27E
AMC 294173	AZCO #366 Amended	415	147	512	907	SEC24-T06S-R27E
AMC 294174	AZCO #367 Amended	415	149	512	909	SEC23-T06S-R27E
AMC 294175	AZCO #368 Amended	415	151	512	911	SEC23-T06S-R27E
AMC 294176	AZCO #369 Amended	415	153	512	913	SEC23-T06S-R27E
AMC 294177	AZCO #370 Amended	415	155	512	915	SEC23-T06S-R27E
AMC 294178	AZCO #371 Amended	415	157	512	917	SEC23-T06S-R27E
AMC 294179	AZCO #372 Amended	415	159	512	919	SEC23-T06S-R27E
AMC 294180	AZCO #373 Amended	415	161	512	921	SEC23-T06S-R27E
AMC 294181	AZCO #374 Amended	415	163	512	923	SEC23-T06S-R27E
AMC 294182	AZCO #375 Amended	415	165	512	925	SEC23-T06S-R27E
AMC 294183	AZCO #376 Amended	415	167	512	927	SEC23-T06S-R27E
AMC 294184	AZCO #377 Amended	415	169	512	929	SEC23-T06S-R27E
AMC 294185	AZCO #378 Amended	415	171	512	931	SEC23-T06S-R27E
AMC 294186	AZCO #379 Amended	415	173	512	933	SEC23-T06S-R27E
AMC 294187	AZCO #380 Amended	415	175	512	935	SEC23-T06S-R27E
AMC 294188	AZCO #381 Amended	415	177	512	937	SEC26-T06S-R27E
AMC 294189	AZCO #382 Amended	415	179	512	939	SEC26-T06S-R27E
AMC 294190	AZCO #383 Amended	415	181	512	941	SEC26-T06S-R27E
AMC 294191	AZCO #384 Amended	415	183	512	943	SEC26-T06S-R27E
AMC 294192	AZCO #300 Amended	415	43	512	875	SEC30-T06S-R27E
AMC 294193	AZCO #301 Amended	415	45	512	877	SEC30-T06S-R27E
AMC 294194	AZCO #302 Amended	415	47	512	879	SEC25-T06S-R27E
AMC 294195	AZCO #303 Amended	415	49	512	881	SEC25-T06S-R27E
AMC 294196	AZCO #304 Amended	415	51	512	883	SEC25-T06S-R27E
AMC 294197	AZCO #305 Amended	415	53	512	885	SEC30-T06S-R27E
AMC 294198	AZCO #306 Amended	415	55	512	887	SEC30-T06S-R27E

Date: 7/25/2016

RECEIVED  
BLM AZ STATE OFFICE

## EXHIBIT A

County: Graham

State: AZ

<u>BLM Serial #</u>	<u>Claim Name</u>	<u>Original Recording</u>		<u>Amended Recording</u>		<u>Location</u>
		<u>Recording #</u>	<u>Page #</u>	<u>Recording #</u>	<u>Page #</u>	
AMC 294348	LS-39	415	305			SEC31-T05S-R27E
AMC 294349	LS-40	415	319			SEC31-T05S-R27E
AMC 294350	LS-41	415	303			SEC31-T05S-R27E
AMC 298852	LS-53	419	998			SEC20-T06S-R27E
AMC 298855	LS-56	420	5			SEC20-T06S-R27E
AMC 298861	AZCO #44 Amended	419	636	512	727	SEC34-T06S-R27E
AMC 298862	AZCO #45 Amended	419	638	512	729	SEC34-T06S-R27E
AMC 298867	AZCO #185 Amended	419	634	512	845	SEC26-T06S-R27E
AMC 298868	AZCO #400 Amended	419	616	512	945	SEC36-T06S-R27E
AMC 298870	AZCO #402 Amended	419	620	512	947	SEC36-T06S-R27E
AMC 298876	AZCO #410 Amended	419	632	512	949	SEC36-T06S-R27E
AMC 298877	AZCO #411 Amended	419	648	512	951	SEC29-T06S-R27E
AMC 298878	AZCO #412 Amended	419	650	512	953	SEC29-T06S-R27E
AMC 298879	AZCO #413 Amended	419	652	512	955	SEC29-T06S-R27E
AMC 298880	AZCO #414 Amended	419	654	512	957	SEC29-T06S-R27E
AMC 298881	AZCO #415 Amended	419	656	512	959	SEC29-T06S-R27E
AMC 298882	AZCO #416 Amended	419	658	512	961	SEC29-T06S-R27E
AMC 298883	AZCO #417 Amended	419	660	512	963	SEC29-T06S-R27E
AMC 298884	AZCO #418 Amended	419	662	512	965	SEC29-T06S-R27E
AMC 298885	AZCO #419 Amended	419	664	512	967	SEC29-T06S-R27E
AMC 298886	AZCO #420 Amended	419	666	512	969	SEC29-T06S-R27E
AMC 298887	AZCO #421 Amended	419	668	512	971	SEC29-T06S-R27E
AMC 298888	AZCO #422 Amended	419	670	512	973	SEC29-T06S-R27E
AMC 298889	AZCO #423 Amended	419	672	512	975	SEC29-T06S-R27E
AMC 298890	AZCO #424 Amended	419	674	512	977	SEC29-T06S-R27E
AMC 298891	AZCO #425 Amended	419	676	512	979	SEC29-T06S-R27E
AMC 298892	AZCO #426 Amended	419	678	512	981	SEC29-T06S-R27E
AMC 298893	AZCO #427 Amended	419	680	512	983	SEC29-T06S-R27E
AMC 298894	AZCO #428 Amended	419	682	512	985	SEC29-T06S-R27E
AMC 298895	AZCO #429 Amended	419	684	512	987	SEC29-T06S-R27E
AMC 298896	AZCO #430 Amended	419	686	512	989	SEC29-T06S-R27E
AMC 298897	AZCO #461 Amended	419	708	513	11	SEC28-T06S-R27E
AMC 298898	AZCO #462 Amended	419	710	513	13	SEC28-T06S-R27E
AMC 298899	AZCO #463 Amended	419	712	513	15	SEC28-T06S-R27E
AMC 298929	AZCO #190 Amended	419	818	512	847	SEC27-T06S-R27E
AMC 298930	AZCO #191 Amended	419	819	512	849	SEC27-T06S-R27E
AMC 298931	AZCO #192 Amended	419	822	512	851	SEC27-T06S-R27E
AMC 298932	AZCO #193 Amended	419	823	512	853	SEC27-T06S-R27E

Date: 7/25/2016

ARIZONA

AUG 19 2016

RECEIVED BLM AZ STATE OFFICE

## EXHIBIT A

County: Graham

State: AZ

BLM Serial #	Claim Name	Original Recording		Amended Recording		Location
		Recording #	Page #	Recording #	Page #	
AMC 298933	AZCO #194 Amended	419	826	512	855	SEC27-T06S-R27E
AMC 298934	AZCO #358 Amended	419	828	512	891	SEC24-T06S-R27E
AMC 298935	AZCO #360 Amended	419	830	512	895	SEC24-T06S-R27E
AMC 298936	AZCO #362 Amended	419	832	512	899	SEC24-T06S-R27E
AMC 305755	AZCO #441 Amended	426	703	512	991	SEC29-T06S-R27E
AMC 305756	AZCO #442 Amended	426	705	512	993	SEC29-T06S-R27E
AMC 305757	AZCO #443 Amended	426	707	512	995	SEC29-T06S-R27E
AMC 305758	AZCO #444 Amended	426	709	512	997	SEC21-T06S-R27E
AMC 305759	AZCO #445 Amended	426	711	512	999	SEC20-T06S-R27E
AMC 305760	AZCO #446 Amended	426	713	513	1	SEC20-T06S-R27E
AMC 305761	AZCO #447 Amended	426	715	513	03	SEC20-T06S-R27E
AMC 305762	AZCO #448 Amended	426	717	513	05	SEC20-T06S-R27E
AMC 305763	AZCO #449 Amended	426	719	513	07	SEC20-T06S-R27E
AMC 305764	AZCO #450 Amended	426	721	513	09	SEC20-T06S-R27E
AMC 321860	M1	448	441			SEC15-T06S-R27E
AMC 321861	M2	448	443			SEC15-T06S-R27E
AMC 321862	M3	448	445			SEC15-T06S-R27E
AMC 321863	M4	448	447			SEC15-T06S-R27E
AMC 321864	M5	448	449			SEC15-T06S-R27E
AMC 321865	M6	448	451			SEC15-T06S-R27E
AMC 321866	M7	448	453			SEC15-T06S-R27E
AMC 321867	M8	448	455			SEC15-T06S-R27E
AMC 321868	M9	448	457			SEC15-T06S-R27E
AMC 321869	M10	448	459			SEC15-T06S-R27E
AMC 321870	M11	448	461			SEC15-T06S-R27E
AMC 321871	M12	448	463			SEC15-T06S-R27E
AMC 321872	M13	448	465			SEC15-T06S-R27E
AMC 321873	M14	448	467			SEC15-T06S-R27E
AMC 321874	M15	448	469			SEC15-T06S-R27E
AMC 321875	M16	448	471			SEC15-T06S-R27E
AMC 321876	M17	448	473			SEC15-T06S-R27E
AMC 321877	M18	448	475			SEC15-T06S-R27E
AMC 321878	M37	448	477			SEC10-T06S-R27E
AMC 321879	M38	448	479			SEC10-T06S-R27E
AMC 321880	M39	448	481			SEC15-T06S-R27E
AMC 321881	M40	448	483			SEC15-T06S-R27E
AMC 321882	M41	448	485			SEC15-T06S-R27E
AMC 321883	M42	448	487			SEC15-T06S-R27E

Date: 7/25/2016

RECEIVED  
BLM AZ STATE OFFICE

2016 AUG - 3 A 9: 20  
PHOENIX, ARIZONA

## EXHIBIT A

County: Graham

State: AZ

<u>BLM Serial #</u>	<u>Claim Name</u>	<u>Original Recording</u>		<u>Amended Recording</u>		<u>Location</u>
		<u>Recording #</u>	<u>Page #</u>	<u>Recording #</u>	<u>Page #</u>	
AMC 321884	M43	448	489			SEC15-T06S-R27E
AMC 321885	M44	448	491			SEC15-T06S-R27E
AMC 321886	M45	448	493			SEC15-T06S-R27E
AMC 321887	M46	448	495			SEC15-T06S-R27E
AMC 321888	M47	448	497			SEC15-T06S-R27E
AMC 321889	M48	448	499			SEC15-T06S-R27E
AMC 321890	M49	448	501			SEC15-T06S-R27E
AMC 321891	M50	448	503			SEC15-T06S-R27E
AMC 321892	M51	448	505			SEC15-T06S-R27E
AMC 321893	M52	448	507			SEC15-T06S-R27E
AMC 321894	M53	448	509			SEC15-T06S-R27E
AMC 321895	M54	448	511			SEC15-T06S-R27E
AMC 321896	M73	448	513			SEC10-T06S-R27E
AMC 321897	M74	448	515			SEC10-T06S-R27E
AMC 321898	M75	448	517			SEC10-T06S-R27E
AMC 321899	M76	448	519			SEC10-T06S-R27E
AMC 321900	M77	448	521			SEC10-T06S-R27E
AMC 321901	M78	448	523			SEC10-T06S-R27E
AMC 321902	M79	448	525			SEC10-T06S-R27E
AMC 321903	M80	448	527			SEC10-T06S-R27E
AMC 321904	M81	448	529			SEC10-T06S-R27E
AMC 321905	M82	448	531			SEC10-T06S-R27E
AMC 321906	M83	448	533			SEC10-T06S-R27E
AMC 321907	M84	448	535			SEC10-T06S-R27E
AMC 321908	M85	448	537			SEC10-T06S-R27E
AMC 321909	M86	448	539			SEC10-T06S-R27E
AMC 321910	M87	448	541			SEC11-T06S-R27E
AMC 321911	M88	448	543			SEC11-T06S-R27E
AMC 321912	M89	448	545			SEC11-T06S-R27E
AMC 321913	M90	448	547			SEC11-T06S-R27E
AMC 321914	M91	448	549			SEC11-T06S-R27E
AMC 321915	M92	448	551			SEC11-T06S-R27E
AMC 321916	M93	448	553			SEC11-T06S-R27E
AMC 321917	M94	448	555			SEC11-T06S-R27E
AMC 321918	M95	448	557			SEC11-T06S-R27E
AMC 321919	M96	448	559			SEC11-T06S-R27E
AMC 321920	M97	448	561			SEC11-T06S-R27E
AMC 321921	M98	448	563			SEC11-T06S-R27E

Date: 7/25/2016

Page 16

RECEIVED  
 BLM AZ STATE OFFICE  
 2016 AUG - 3 A 9 21  
 HOENIX, ARIZONA

## EXHIBIT A

County: Graham

State: AZ

<u>BLM Serial #</u>	<u>Claim Name</u>	<u>Original Recording</u>		<u>Amended Recording</u>		<u>Location</u>
		<u>Recording #</u>	<u>Page #</u>	<u>Recording #</u>	<u>Page #</u>	
AMC 321922	M99	448	565			SEC11-T06S-R27E
AMC 321923	M100	448	567			SEC11-T06S-R27E
AMC 321924	M101	448	569			SEC11-T06S-R27E
AMC 321925	M102	448	571			SEC11-T06S-R27E
AMC 321926	M103	448	573			SEC11-T06S-R27E
AMC 321927	M104	448	575			SEC11-T06S-R27E
AMC 321928	M105	448	577			SEC10-T06S-R27E
AMC 321929	M106	448	579			SEC10-T06S-R27E
AMC 321930	M107	448	581			SEC10-T06S-R27E
AMC 321931	M108	448	583			SEC10-T06S-R27E
AMC 321932	M109	448	585			SEC10-T06S-R27E
AMC 321933	M110	448	587			SEC11-T06S-R27E
AMC 321934	M111	448	589			SEC11-T06S-R27E
AMC 321935	M112	448	591			SEC11-T06S-R27E
AMC 321936	M113	448	593			SEC11-T06S-R27E
AMC 321937	M114	448	595			SEC11-T06S-R27E
AMC 321938	M115	448	597			SEC11-T06S-R27E
AMC 321939	M116	448	599			SEC11-T06S-R27E
AMC 321940	M117	448	601			SEC11-T06S-R27E
AMC 321941	M118	448	603			SEC11-T06S-R27E
AMC 321942	M119	448	605			SEC10-T06S-R27E
AMC 321943	M120	448	607			SEC10-T06S-R27E
AMC 321944	M121	448	609			SEC11-T06S-R27E
AMC 321945	M122	448	611			SEC11-T06S-R27E
AMC 321946	M123	448	613			SEC11-T06S-R27E
AMC 321947	M124	448	615			SEC11-T06S-R27E
AMC 324229	M56	452	54			SEC11-T06S-R27E
AMC 324230	M58	452	56			SEC14-T06S-R27E
AMC 324231	M60	452	58			SEC11-T06S-R27E
AMC 324232	M62	452	60			SEC11-T06S-R27E
AMC 324233	M64	452	62			SEC11-T06S-R27E
AMC 324234	M66	452	64			SEC11-T06S-R27E
AMC 324235	M68	452	66			SEC11-T06S-R27E
AMC 324236	M70	452	68			SEC11-T06S-R27E
AMC 324237	M72	452	70			SEC11-T06S-R27E
AMC 324367	AZCO #465 Amended	449	937	513	17	SEC28-T06S-R27E
AMC 324368	AZCO #466 Amended	449	939	513	19	SEC28-T06S-R27E
AMC 324369	AZCO #467 Amended	449	941	513	21	SEC28-T06S-R27E

Date: 7/25/2016

Page 17

RECEIVED  
BLM AZ STATE OFFICE  
2016 AUG - 3 A 9: 21  
HOEHLIX, ARIZONA

## EXHIBIT A

County: Graham

State: AZ

BLM Serial #	Claim Name	Original Recording		Amended Recording		Location
		Recording #	Page #	Recording #	Page #	
AMC 324370	AZCO #468 Amended	449	943	513	23	SEC28-T06S-R27E
AMC 324371	AZCO #469 Amended	449	945	513	25	SEC21-T06S-R27E
AMC 324892	MG 121	453	901			SEC30-T05S-R26E
AMC 324893	MG 122	453	903			SEC30-T05S-R26E
AMC 324894	MG 123	453	905			SEC30-T05S-R26E
AMC 324895	MG 124	453	907			SEC30-T05S-R26E
AMC 324896	MG 125	453	909			SEC30-T05S-R26E
AMC 324897	MG 126	453	911			SEC30-T05S-R26E
AMC 324898	MG 127	453	913			SEC30-T05S-R26E
AMC 324899	MG 128	453	915			SEC30-T05S-R26E
AMC 324900	MG 129	453	917			SEC30-T05S-R26E
AMC 324901	MG 130	453	919			SEC30-T05S-R26E
AMC 324902	MG 179	453	933			SEC25-T05S-R25E
AMC 324903	MG 180	453	935			SEC25-T05S-R25E
AMC 324904	MG 181	453	937			SEC25-T05S-R25E
AMC 324905	MG 182	453	939			SEC25-T05S-R25E
AMC 324906	MG 183	453	941			SEC25-T05S-R25E
AMC 324907	MG 184	453	943			SEC25-T05S-R25E
AMC 324908	MG 185	453	945			SEC25-T05S-R25E
AMC 324909	MG 186	453	947			SEC25-T05S-R25E
AMC 324910	MG 187	453	949			SEC25-T05S-R25E
AMC 324911	MG 188	453	951			SEC25-T05S-R25E
AMC 324912	MG 189	453	953			SEC25-T05S-R25E
AMC 324913	MG 190	453	955			SEC25-T05S-R25E
AMC 324914	MG 191	453	957			SEC25-T05S-R25E
AMC 324915	MG 192	453	959			SEC25-T05S-R25E
AMC 324916	MG 193	453	961			SEC25-T05S-R25E
AMC 324917	MG 194	453	963			SEC25-T05S-R25E
AMC 324918	MG 195	453	965			SEC25-T05S-R25E
AMC 324919	MG 196	453	967			SEC25-T05S-R25E
AMC 324920	MG 223	453	969			SEC25-T05S-R25E
AMC 324921	MG 224	453	971			SEC25-T05S-R25E
AMC 324922	MG 225	453	973			SEC25-T05S-R25E
AMC 324923	MG 226	453	975			SEC25-T05S-R25E
AMC 324924	MG 227	453	977			SEC25-T05S-R25E
AMC 324925	MG 228	453	979			SEC25-T05S-R25E
AMC 324926	MG 229	453	981			SEC25-T05S-R25E
AMC 324927	MG 230	453	983			SEC25-T05S-R25E

Date: 7/25/2016

RECEIVED  
BLM AZ STATE OFFICE

## EXHIBIT A

County: Graham

State: AZ

BLM Serial #	Claim Name	Original Recording		Amended Recording		Location
		Recording #	Page #	Recording #	Page #	
AMC 324928	MG 231	453	985			SEC25-T05S-R25E
AMC 324929	MG 232	453	987			SEC25-T05S-R25E
AMC 324930	MG 233	453	989			SEC25-T05S-R25E
AMC 324931	MG 234	453	991			SEC25-T05S-R25E
AMC 324932	MG 235	453	993			SEC25-T05S-R25E
AMC 324933	MG 236	453	995			SEC25-T05S-R25E
AMC 324934	MG 237	453	997			SEC25-T05S-R25E
AMC 324935	MG 238	453	999			SEC25-T05S-R25E
AMC 324936	MG 239	454	1			SEC25-T05S-R25E
AMC 324937	MG 240	454	2A			SEC25-T05S-R25E
AMC 326065	SOB 1	458	703			SEC27-T06S-R27E
AMC 326066	SOB 2	458	704			SEC27-T06S-R27E
AMC 326067	SOB 3	458	705			SEC27-T06S-R27E
AMC 326068	SOB 4	458	706			SEC27-T06S-R27E
AMC 326069	SOB 5	458	707			SEC27-T06S-R27E
AMC 326070	SOB 6	458	708			SEC27-T06S-R27E
AMC 326071	SOB 7	458	709			SEC27-T06S-R27E
AMC 326072	SOB 8	458	710			SEC27-T06S-R27E
AMC 326073	SOB 9	458	711			SEC27-T06S-R27E
AMC 326074	SOB 10	458	712			SEC27-T06S-R27E
AMC 326075	SOB 11	458	713			SEC27-T06S-R27E
AMC 326076	SOB 12	458	714			SEC27-T06S-R27E
AMC 326077	SOB 13	458	715			SEC29-T06S-R27E
AMC 326078	SOB 14	458	716			SEC29-T06S-R27E
AMC 326079	SOB 15	458	717			SEC29-T06S-R27E
AMC 326080	SOB 16	458	718			SEC29-T06S-R27E
AMC 326081	SOB 17	458	719			SEC29-T06S-R27E
AMC 326082	SOB 18	458	720			SEC29-T06S-R27E
AMC 326083	SOB 19	458	721			SEC20-T06S-R27E
AMC 326084	SOB 20	458	722			SEC20-T06S-R27E
AMC 326085	SOB 21	458	723			SEC20-T06S-R27E
AMC 326086	SOB 22	458	724			SEC20-T06S-R27E
AMC 326087	SOB 23	458	725			SEC29-T06S-R27E
AMC 326088	SOB 24	458	726			SEC29-T06S-R27E
AMC 326089	SOB 25	458	727			SEC29-T06S-R27E
AMC 326090	SOB 26	458	728			SEC29-T06S-R27E
AMC 326091	SOB 27	458	729			SEC29-T06S-R27E
AMC 326092	SOB 28	458	730			SEC29-T06S-R27E

Date: 7/25/2016

RECEIVED  
 BLM AZ STATE OFFICE  
 2016 AUG - 3 A 9 21  
 PHOENIX, ARIZONA



## EXHIBIT A

County: Graham

State: AZ

<u>BLM Serial #</u>	<u>Claim Name</u>	<u>Original Recording</u>		<u>Amended Recording</u>		<u>Location</u>
		<u>Recording #</u>	<u>Page #</u>	<u>Recording #</u>	<u>Page #</u>	
AMC 326093	SOB 29	458	731			SEC29-T06S-R27E
AMC 326094	SOB 30	458	732			SEC29-T06S-R27E
AMC 326095	SOB 31	458	733			SEC29-T06S-R27E
AMC 326096	SOB 32	458	734			SEC29-T06S-R27E
AMC 326097	SOB 33	458	735			SEC29-T06S-R27E
AMC 326098	SOB 34	458	736			SEC29-T06S-R27E
AMC 326099	SOB 35	458	737			SEC29-T06S-R27E
AMC 326100	SOB 36	458	738			SEC29-T06S-R27E
AMC 326101	SOB 37	458	739			SEC29-T06S-R27E
AMC 326102	SOB 38	458	740			SEC29-T06S-R27E
AMC 326103	SOB 39	458	741			SEC29-T06S-R27E
AMC 326104	SOB 40	458	742			SEC29-T06S-R27E
AMC 326105	SOB 41	458	743			SEC29-T06S-R27E
AMC 326106	SOB 42	458	744			SEC29-T06S-R27E
AMC 326107	SOB 43	458	745			SEC29-T06S-R27E
AMC 326108	SOB 44	458	746			SEC29-T06S-R27E
AMC 326109	SOB 45	458	747			SEC29-T06S-R27E
AMC 326110	SOB 46	458	748			SEC29-T06S-R27E
AMC 326111	SOB 47	458	749			SEC21-T06S-R27E
AMC 326112	SOB 48	458	750			SEC21-T06S-R27E
AMC 326113	SOB 49	458	751			SEC21-T06S-R27E
AMC 326114	SOB 50	458	752			SEC21-T06S-R27E
AMC 326115	SOB 51	458	753			SEC28-T06S-R27E
AMC 326116	SOB 52	458	754			SEC28-T06S-R27E
AMC 326117	SOB 53	458	755			SEC28-T06S-R27E
AMC 326118	SOB 54	458	756			SEC28-T06S-R27E
AMC 326119	SOB 55	458	757			SEC28-T06S-R27E
AMC 326120	SOB 56	458	758			SEC28-T06S-R27E
AMC 326121	SOB 57	458	759			SEC28-T06S-R27E
AMC 326122	SOB 58	458	760			SEC28-T06S-R27E
AMC 326123	SOB 59	458	761			SEC28-T06S-R27E
AMC 326124	SOB 60	458	762			SEC28-T06S-R27E
AMC 326125	SOB 61	458	763			SEC28-T06S-R27E
AMC 326126	SOB 62	458	764			SEC28-T06S-R27E
AMC 326127	SOB 63	458	765			SEC28-T06S-R27E
AMC 326128	SOB 64	458	766			SEC28-T06S-R27E
AMC 326129	SOB 65	458	767			SEC28-T06S-R27E
AMC 326130	SOB 66	458	768			SEC28-T06S-R27E

Date: 7/25/2016

RECEIVED  
 BLM AZ STATE OFFICE  
 2016 AUG - 3 A 9:21  
 PHOENIX, ARIZONA

## EXHIBIT A

County: Graham

State: AZ

<u>BLM Serial #</u>	<u>Claim Name</u>	<u>Original Recording</u>		<u>Amended Recording</u>		<u>Location</u>
		<u>Recording #</u>	<u>Page #</u>	<u>Recording #</u>	<u>Page #</u>	
AMC 326131	SOB 67	458	769			SEC28-T06S-R27E
AMC 326132	SOB 68	458	770			SEC28-T06S-R27E
AMC 326133	SOB 69	458	771			SEC28-T06S-R27E
AMC 326134	SOB 70	458	772			SEC28-T06S-R27E
AMC 326135	SOB 71	458	773			SEC28-T06S-R27E
AMC 326136	SOB 72	458	774			SEC28-T06S-R27E
AMC 326137	SOB 73	458	775			SEC28-T06S-R27E
AMC 326138	SOB 74	458	776			SEC28-T06S-R27E
AMC 326139	SOB 75	458	777			SEC28-T06S-R27E
AMC 326140	SOB 76	458	778			SEC28-T06S-R27E
AMC 326141	SOB 77	458	779			SEC21-T06S-R27E
AMC 326142	SOB 78	458	780			SEC21-T06S-R27E
AMC 326143	SOB 79	458	781			SEC28-T06S-R27E
AMC 326144	SOB 80	458	782			SEC28-T06S-R27E
AMC 326145	SOB 81	458	783			SEC28-T06S-R27E
AMC 326146	SOB 82	458	784			SEC28-T06S-R27E
AMC 326147	SOB 83	458	785			SEC28-T06S-R27E
AMC 326148	SOB 84	458	786			SEC28-T06S-R27E
AMC 326149	SOB 85	458	787			SEC28-T06S-R27E
AMC 326150	SOB 86	458	788			SEC28-T06S-R27E
AMC 326151	SOB 87	458	789			SEC28-T06S-R27E
AMC 326152	SOB 88	458	790			SEC28-T06S-R27E
AMC 326153	SOB 89	458	791			SEC28-T06S-R27E
AMC 326154	SOB 90	458	792			SEC28-T06S-R27E
AMC 326155	SOB 91	458	793			SEC28-T06S-R27E
AMC 326156	SOB 92	458	794			SEC28-T06S-R27E
AMC 326157	SOB 93	458	795			SEC28-T06S-R27E
AMC 326158	SOB 94	458	796			SEC28-T06S-R27E
AMC 326159	SOB 95	458	797			SEC28-T06S-R27E
AMC 326160	SOB 96	458	798			SEC28-T06S-R27E
AMC 326161	SOB 97	458	799			SEC28-T06S-R27E
AMC 326162	SOB 98	458	800			SEC28-T06S-R27E
AMC 326163	SOB 99	458	801			SEC28-T06S-R27E
AMC 326164	SOB 100	458	802			SEC28-T06S-R27E
AMC 326165	SOB 101	458	803			SEC28-T06S-R27E
AMC 326166	SOB 102	458	804			SEC28-T06S-R27E
AMC 326167	SOB 103	458	805			SEC28-T06S-R27E
AMC 326168	SOB 104	458	806			SEC28-T06S-R27E

Date: 7/25/2016

RECEIVED BLM AZ STATE OFFICE

PHOENIX, ARIZONA  
AUG - 3 2016

## EXHIBIT A

County: Graham

State: AZ

<u>BLM Serial #</u>	<u>Claim Name</u>	<u>Original Recording</u>		<u>Amended Recording</u>		<u>Location</u>
		<u>Recording #</u>	<u>Page #</u>	<u>Recording #</u>	<u>Page #</u>	
AMC 326169	SOB 105	458	807			SEC28-T06S-R27E
AMC 326170	SOB 106	458	808			SEC28-T06S-R27E
AMC 326171	SOB 107	458	809			SEC28-T06S-R27E
AMC 326172	SOB 108	458	810			SEC28-T06S-R27E
AMC 326173	SOB 109	458	811			SEC28-T06S-R27E
AMC 326174	SOB 110	458	812			SEC28-T06S-R27E
AMC 326175	SOB 111	458	813			SEC33-T06S-R27E
AMC 326176	SOB 112	458	814			SEC33-T06S-R27E
AMC 326177	SOB 113	458	815			SEC33-T06S-R27E
AMC 326178	SOB 114	458	816			SEC33-T06S-R27E
AMC 326179	SOB 115	458	817			SEC28-T06S-R27E
AMC 326180	SOB 116	458	818			SEC28-T06S-R27E
AMC 326181	SOB 117	458	819			SEC28-T06S-R27E
AMC 326182	SOB 118	458	820			SEC28-T06S-R27E
AMC 326183	SOB 119	458	821			SEC28-T06S-R27E
AMC 326184	SOB 120	458	822			SEC28-T06S-R27E
AMC 326185	SOB 121	458	823			SEC28-T06S-R27E
AMC 326186	SOB 122	458	824			SEC28-T06S-R27E
AMC 326187	SOB 123	458	825			SEC28-T06S-R27E
AMC 326188	SOB 124	458	826			SEC28-T06S-R27E
AMC 326189	SOB 125	458	827			SEC28-T06S-R27E
AMC 326190	SOB 126	458	828			SEC28-T06S-R27E
AMC 326191	SOB 127	458	829			SEC28-T06S-R27E
AMC 326192	SOB 128	458	830			SEC28-T06S-R27E
AMC 326193	SOB 129	458	831			SEC28-T06S-R27E
AMC 326194	SOB 130	458	832			SEC28-T06S-R27E
AMC 326195	SOB 131	458	833			SEC28-T06S-R27E
AMC 326196	SOB 132	458	834			SEC28-T06S-R27E
AMC 326197	SOB 133	458	835			SEC28-T06S-R27E
AMC 326198	SOB 134	458	836			SEC28-T06S-R27E
AMC 326199	SOB 135	458	837			SEC28-T06S-R27E
AMC 326200	SOB 136	458	838			SEC28-T06S-R27E
AMC 326201	SOB 137	458	839			SEC28-T06S-R27E
AMC 326202	SOB 138	458	840			SEC28-T06S-R27E
AMC 326203	SOB 139	458	841			SEC28-T06S-R27E
AMC 326204	SOB 140	458	842			SEC28-T06S-R27E
AMC 326205	SOB 141	458	843			SEC28-T06S-R27E
AMC 326206	SOB 142	458	844			SEC28-T06S-R27E

Date: 7/25/2016

Page 22

RECEIVED  
BLM AZ STATE OFFICE

PHOENIX, ARIZONA  
2016 AUG - 3 - 9 21

## EXHIBIT A

County: Graham

State: AZ

BLM Serial #	Claim Name	Original Recording		Amended Recording		Location
		Recording #	Page #	Recording #	Page #	
AMC 326207	SOB 143	458	845			SEC28-T06S-R27E
AMC 326208	SOB 144	458	846			SEC28-T06S-R27E
AMC 326209	SOB 145	458	847			SEC28-T06S-R27E
AMC 326210	SOB 146	458	848			SEC33-T06S-R27E
AMC 326211	SOB 147	458	849			SEC33-T06S-R27E
AMC 326212	SOB 148	458	850			SEC33-T06S-R27E
AMC 326213	SOB 149	458	851			SEC33-T06S-R27E
AMC 326214	SOB 150	458	852			SEC33-T06S-R27E
AMC 326215	SOB 151	458	853			SEC33-T06S-R27E
AMC 326216	SOB 152	458	854			SEC28-T06S-R27E
AMC 326217	SOB 153	458	855			SEC28-T06S-R27E
AMC 326218	SOB 154	458	856			SEC28-T06S-R27E
AMC 326219	SOB 155	458	857			SEC28-T06S-R27E
AMC 326220	SOB 156	458	858			SEC28-T06S-R27E
AMC 326221	SOB 157	458	859			SEC28-T06S-R27E
AMC 326222	SOB 158	458	860			SEC28-T06S-R27E
AMC 326223	SOB 159	458	861			SEC28-T06S-R27E
AMC 326224	SOB 160	458	862			SEC28-T06S-R27E
AMC 326225	SOB 161	458	863			SEC28-T06S-R27E
AMC 326226	SOB 162	458	864			SEC28-T06S-R27E
AMC 326227	SOB 163	458	865			SEC28-T06S-R27E
AMC 326228	SOB 164	458	866			SEC28-T06S-R27E
AMC 326229	SOB 165	458	867			SEC28-T06S-R27E
AMC 326230	SOB 166	458	868			SEC28-T06S-R27E
AMC 326231	SOB 167	458	869			SEC28-T06S-R27E
AMC 326232	SOB 168	458	870			SEC28-T06S-R27E
AMC 326233	SOB 169	458	871			SEC28-T06S-R27E
AMC 326234	SOB 170	458	872			SEC28-T06S-R27E
AMC 326235	SOB 171	458	873			SEC28-T06S-R27E
AMC 326236	SOB 172	458	874			SEC28-T06S-R27E
AMC 326237	SOB 173	458	875			SEC28-T06S-R27E
AMC 326238	SOB 174	458	876			SEC28-T06S-R27E
AMC 326239	SOB 175	458	877			SEC28-T06S-R27E
AMC 326240	SOB 176	458	878			SEC28-T06S-R27E
AMC 326241	SOB 177	458	879			SEC28-T06S-R27E
AMC 326242	SOB 178	458	880			SEC28-T06S-R27E
AMC 326243	SOB 179	458	881			SEC28-T06S-R27E
AMC 326244	SOB 180	458	882			SEC33-T06S-R27E

Date: 7/25/2016

RECEIVED  
 BLM AZ STATE OFFICE  
 2016 AUG - 3 A 9 21  
 PHOENIX, ARIZONA

## EXHIBIT A

County: Graham

State: AZ

<u>BLM Serial #</u>	<u>Claim Name</u>	<u>Original Recording</u>		<u>Amended Recording</u>		<u>Location</u>
		<u>Recording #</u>	<u>Page #</u>	<u>Recording #</u>	<u>Page #</u>	
AMC 326245	SOB 181	458	883			SEC33-T06S-R27E
AMC 326246	SOB 182	458	884			SEC33-T06S-R27E
AMC 326247	SOB 183	458	885			SEC33-T06S-R27E
AMC 326248	SOB 184	458	886			SEC33-T06S-R27E
AMC 326249	SOB 185	458	887			SEC33-T06S-R27E
AMC 326250	SOB 186	458	888			SEC33-T06S-R27E
AMC 326251	SOB 187	458	889			SEC33-T06S-R27E
AMC 326252	SOB 188	458	890			SEC27-T06S-R27E
AMC 326253	SOB 189	458	891			SEC27-T06S-R27E
AMC 326254	SOB 190	458	892			SEC27-T06S-R27E
AMC 326255	SOB 191	458	893			SEC27-T06S-R27E
AMC 326256	SOB 192	458	894			SEC27-T06S-R27E
AMC 326257	SOB 193	458	895			SEC27-T06S-R27E
AMC 326258	SOB 194	458	896			SEC27-T06S-R27E
AMC 326259	SOB 195	458	897			SEC27-T06S-R27E
AMC 326260	SOB 196	458	898			SEC27-T06S-R27E
AMC 326261	SOB 197	458	899			SEC27-T06S-R27E
AMC 326262	SOB 198	458	900			SEC27-T06S-R27E
AMC 326263	SOB 199	458	901			SEC27-T06S-R27E
AMC 326264	SOB 200	458	902			SEC27-T06S-R27E
AMC 326265	SOB 201	458	903			SEC27-T06S-R27E
AMC 326266	SOB 202	458	904			SEC27-T06S-R27E
AMC 326267	SOB 203	458	905			SEC27-T06S-R27E
AMC 326268	SOB 204	458	906			SEC27-T06S-R27E
AMC 326269	SOB 205	458	907			SEC27-T06S-R27E
AMC 326270	SOB 206	458	908			SEC27-T06S-R27E
AMC 326271	SOB 207	458	909			SEC27-T06S-R27E
AMC 326272	SOB 208	458	910			SEC27-T06S-R27E
AMC 326273	SOB 209	458	911			SEC27-T06S-R27E
AMC 326274	SOB 210	458	912			SEC27-T06S-R27E
AMC 326275	SOB 211	458	913			SEC27-T06S-R27E
AMC 326276	SOB 212	458	914			SEC27-T06S-R27E
AMC 326277	SOB 213	458	915			SEC27-T06S-R27E
AMC 326278	SOB 214	458	916			SEC34-T06S-R27E
AMC 326279	SOB 215	458	917			SEC34-T06S-R27E
AMC 326280	SOB 216	458	918			SEC26-T06S-R27E
AMC 326281	SOB 217	458	919			SEC26-T06S-R27E
AMC 326282	SOB 218	458	920			SEC26-T06S-R27E

Date: 7/25/2016

Page 24

RECEIVED  
 BLM AZ STATE OFFICE  
 PHOENIX, ARIZONA  
 2016 AUG - 3 A 9 21

## EXHIBIT A

County: Graham

State: AZ

<u>BLM Serial #</u>	<u>Claim Name</u>	<u>Original Recording</u>		<u>Amended Recording</u>		<u>Location</u>
		<u>Recording #</u>	<u>Page #</u>	<u>Recording #</u>	<u>Page #</u>	
AMC 326843	M19	463	593			SEC14-T06S-R27E
AMC 326844	M20	463	595			SEC14-T06S-R27E
AMC 326845	M21	463	597			SEC14-T06S-R27E
AMC 326846	M22	463	599			SEC14-T06S-R27E
AMC 326847	M23	463	601			SEC14-T06S-R27E
AMC 326848	M24	463	603			SEC14-T06S-R27E
AMC 326849	M25	463	605			SEC14-T06S-R27E
AMC 326850	M26	463	607			SEC14-T06S-R27E
AMC 326851	M27	463	609			SEC14-T06S-R27E
AMC 326852	M28	463	611			SEC14-T06S-R27E
AMC 326853	M29	463	613			SEC14-T06S-R27E
AMC 326854	M30	463	615			SEC14-T06S-R27E
AMC 326855	M31	463	617			SEC14-T06S-R27E
AMC 326856	M55	463	629			SEC14-T06S-R27E
AMC 326857	M32	463	619			SEC14-T06S-R27E
AMC 326858	M33	463	621			SEC14-T06S-R27E
AMC 326859	M34	463	623			SEC14-T06S-R27E
AMC 326860	M35	463	625			SEC14-T06S-R27E
AMC 326861	M36	463	627			SEC14-T06S-R27E
AMC 326862	M57	463	631			SEC14-T06S-R27E
AMC 326863	M59	463	633			SEC14-T06S-R27E
AMC 326864	M61	463	635			SEC14-T06S-R27E
AMC 326865	M63	463	637			SEC14-T06S-R27E
AMC 326866	M65	463	639			SEC14-T06S-R27E
AMC 326867	M67	463	641			SEC14-T06S-R27E
AMC 326868	M69	463	643			SEC14-T06S-R27E
AMC 326869	M71	463	645			SEC14-T06S-R27E
AMC 326870	M145	463	647			SEC14-T06S-R27E
AMC 326871	M146	463	649			SEC22-T06S-R27E
AMC 326872	M147	463	651			SEC22-T06S-R27E
AMC 326873	M148	463	653			SEC22-T06S-R27E
AMC 326874	M149	463	655			SEC22-T06S-R27E
AMC 326875	M150	463	657			SEC22-T06S-R27E
AMC 326876	M151	463	659			SEC22-T06S-R27E
AMC 326877	M152	463	661			SEC22-T06S-R27E
AMC 326878	M153	463	663			SEC22-T06S-R27E
AMC 326879	M154	463	665			SEC22-T06S-R27E
AMC 326880	M155	463	667			SEC22-T06S-R27E

Date: 7/25/2016

RECEIVED  
BLM AZ STATE OFFICE

PHOENIX, ARIZONA  
2016 AUG -3 A 9:21

## EXHIBIT A

County: Graham

State: AZ

<u>BLM Serial #</u>	<u>Claim Name</u>	<u>Original Recording</u>		<u>Amended Recording</u>		<u>Location</u>
		<u>Recording #</u>	<u>Page #</u>	<u>Recording #</u>	<u>Page #</u>	
AMC 326881	M156	463	669			SEC22-T06S-R27E
AMC 326882	M157	463	671			SEC22-T06S-R27E
AMC 326883	M158	463	673			SEC22-T06S-R27E
AMC 326884	M159	463	675			SEC22-T06S-R27E
AMC 326885	M160	463	677			SEC22-T06S-R27E
AMC 326886	M161	463	679			SEC22-T06S-R27E
AMC 326887	M162	463	681			SEC22-T06S-R27E
AMC 326888	M163	463	683			SEC23-T06S-R27E
AMC 326889	M164	463	685			SEC23-T06S-R27E
AMC 326890	M165	463	687			SEC23-T06S-R27E
AMC 326891	M166	463	689			SEC23-T06S-R27E
AMC 326892	M167	463	691			SEC23-T06S-R27E
AMC 326893	M168	463	693			SEC23-T06S-R27E
AMC 326894	M169	463	695			SEC23-T06S-R27E
AMC 326895	M170	463	697			SEC23-T06S-R27E
AMC 326896	M171	463	699			SEC23-T06S-R27E
AMC 326897	M172	463	701			SEC23-T06S-R27E
AMC 326898	M173	463	703			SEC23-T06S-R27E
AMC 326899	M174	463	705			SEC23-T06S-R27E
AMC 326900	M175	463	707			SEC23-T06S-R27E
AMC 326901	M176	463	709			SEC23-T06S-R27E
AMC 326902	M177	463	711			SEC23-T06S-R27E
AMC 326903	M178	463	713			SEC23-T06S-R27E
AMC 326904	M188	463	715			SEC22-T06S-R27E
AMC 326905	M189	463	717			SEC22-T06S-R27E
AMC 326906	M190	463	719			SEC22-T06S-R27E
AMC 326907	M191	463	721			SEC22-T06S-R27E
AMC 326908	M192	463	723			SEC22-T06S-R27E
AMC 326909	M193	463	725			SEC22-T06S-R27E
AMC 326910	M194	463	727			SEC22-T06S-R27E
AMC 326911	M195	463	729			SEC22-T06S-R27E
AMC 326912	M196	463	731			SEC22-T06S-R27E
AMC 326913	M197	463	733			SEC23-T06S-R27E
AMC 326914	M199	463	735			SEC22-T06S-R27E
AMC 326915	M200	463	737			SEC22-T06S-R27E
AMC 326916	M201	463	739			SEC22-T06S-R27E
AMC 326917	M202	463	741			SEC22-T06S-R27E
AMC 326918	M203	463	743			SEC22-T06S-R27E

Date: 7/25/2016

Page 26

RECEIVED  
 BLM AZ STATE OFFICE  
 PHOENIX, ARIZONA  
 2016 AUG - 3 A 9 21

## EXHIBIT A

County: Graham

State: AZ

BLM Serial #	Claim Name	Original Recording		Amended Recording		Location
		Recording #	Page #	Recording #	Page #	
AMC 326919	M204	463	745			SEC22-T06S-R27E
AMC 326920	M205	463	747			SEC22-T06S-R27E
AMC 326921	M206	463	749			SEC22-T06S-R27E
AMC 329068	MG 5	471	483			SEC20-T05S-R26E
AMC 329077	MG 24	471	501			SEC20-T05S-R26E
AMC 329078	MG 25	471	503			SEC20-T05S-R26E
AMC 329087	MG 83	471	521			SEC19-T05S-R26E
AMC 329088	MG 84	471	523			SEC19-T05S-R26E
AMC 329089	MG 131	471	525			SEC19-T05S-R26E
AMC 329090	MG 133	471	527			SEC19-T05S-R26E
AMC 329091	MG 135	471	529			SEC19-T05S-R26E
AMC 329092	MG 137	471	531			SEC19-T05S-R26E
AMC 329093	MG 139	471	533			SEC19-T05S-R26E
AMC 329113	Joy 179	471	573			SEC10-T06S-R26E
AMC 329115	Joy 181	471	577			SEC10-T06S-R26E
AMC 329123	Joy 189	471	593			SEC10-T06S-R26E
AMC 329124	Joy 190	471	595			SEC11-T06S-R26E
AMC 329125	Joy 191	471	597			SEC11-T06S-R26E
AMC 329126	Joy 192	471	599			SEC11-T06S-R26E
AMC 329127	Joy 193	471	601			SEC11-T06S-R26E
AMC 329128	Joy 194	471	603			SEC11-T06S-R26E
AMC 329129	Joy 195	471	605			SEC11-T06S-R26E
AMC 329130	Joy 196	471	607			SEC11-T06S-R26E
AMC 329144	Joy 210A	471	635	481	919	SEC02-T06S-R26E
AMC 329145	Joy 212A	471	637	481	923	SEC02-T06S-R26E
AMC 330969	Joy 214	478	215			SEC02-T06S-R26E
AMC 330971	Joy 216	478	219			SEC02-T06S-R26E
AMC 330973	Joy 218	478	223			SEC02-T06S-R26E
AMC 331745	Joy 303	483	801			SEC14-T06S-R26E
AMC 331747	Joy 305	483	805			SEC14-T06S-R26E
AMC 331749	Joy 307	483	809			SEC14-T06S-R26E
AMC 331751	Joy 309	483	813			SEC14-T06S-R26E
AMC 331752	Joy 310	483	815			SEC14-T06S-R26E
AMC 331753	Joy 312	483	817			SEC14-T06S-R26E
AMC 333390	M207	488	141			SEC21-T06S-R27E
AMC 333391	M208	488	143			SEC21-T06S-R27E
AMC 333392	M209	488	145			SEC21-T06S-R27E
AMC 333393	M210	488	147			SEC21-T06S-R27E

Date: 7/25/2016

RECEIVED BLM AZ STATE OFFICE



## EXHIBIT A

County: Graham

State: AZ

<u>BLM Serial #</u>	<u>Claim Name</u>	<u>Original Recording</u>		<u>Amended Recording</u>		<u>Location</u>
		<u>Recording #</u>	<u>Page #</u>	<u>Recording #</u>	<u>Page #</u>	
AMC 333394	M211	488	149			SEC21-T06S-R27E
AMC 333395	M212	488	151			SEC21-T06S-R27E
AMC 333396	M213	488	153			SEC21-T06S-R27E
AMC 333397	M214	488	155			SEC21-T06S-R27E
AMC 333398	M215	488	157			SEC21-T06S-R27E
AMC 333399	M216	488	159			SEC21-T06S-R27E
AMC 333400	M217	488	161			SEC21-T06S-R27E
AMC 333401	M218	488	163			SEC21-T06S-R27E
AMC 333402	M219	488	165			SEC21-T06S-R27E
AMC 333403	M220	488	167			SEC21-T06S-R27E
AMC 333404	M221	488	169			SEC21-T06S-R27E
AMC 333405	M222	488	171			SEC21-T06S-R27E
AMC 333406	M223	488	173			SEC21-T06S-R27E
AMC 333407	M224	488	175			SEC21-T06S-R27E
AMC 333408	M225	488	177			SEC21-T06S-R27E
AMC 333409	M226	488	179			SEC21-T06S-R27E
AMC 333410	M227	488	181			SEC21-T06S-R27E
AMC 333411	M228	488	183			SEC21-T06S-R27E
AMC 333412	M229	488	185			SEC21-T06S-R27E
AMC 333413	M230	488	187			SEC21-T06S-R27E
AMC 333414	M231	488	189			SEC21-T06S-R27E
AMC 333415	M232	488	191			SEC21-T06S-R27E
AMC 333416	M233	488	193			SEC21-T06S-R27E
AMC 333417	M234	488	195			SEC21-T06S-R27E
AMC 333418	M235	488	197			SEC21-T06S-R27E
AMC 333419	M236	488	199			SEC21-T06S-R27E
AMC 333420	M237	488	201			SEC16-T06S-R27E
AMC 333421	M238	488	203			SEC16-T06S-R27E
AMC 334772	CHE 1	492	843			SEC23-T05S-R25E
AMC 334773	CHE 2	492	845			SEC23-T05S-R25E
AMC 334774	CHE 3	492	847			SEC23-T05S-R25E
AMC 334775	CHE 4	492	849			SEC23-T05S-R25E
AMC 334776	CHE 5	492	851			SEC23-T05S-R25E
AMC 334777	CHE 6	492	853			SEC23-T05S-R25E
AMC 334778	CHE 7	492	855			SEC23-T05S-R25E
AMC 334779	CHE 8	492	857			SEC23-T05S-R25E
AMC 334780	CHE 9	492	859			SEC23-T05S-R25E
AMC 334781	CHE 10	492	861			SEC23-T05S-R25E

Date: 7/25/2016

Page 28

RECEIVED  
 BLM AZ STATE OFFICE  
 2016 AUG - 3 9 22  
 PHOENIX, ARIZONA

## EXHIBIT A

County: Graham

State: AZ

<u>BLM Serial #</u>	<u>Claim Name</u>	<u>Original Recording</u>		<u>Amended Recording</u>		<u>Location</u>
		<u>Recording #</u>	<u>Page #</u>	<u>Recording #</u>	<u>Page #</u>	
AMC 334782	CHE 11	492	863			SEC26-T05S-R25E
AMC 334783	CHE 12	492	865			SEC26-T05S-R25E
AMC 334784	CHE 13	492	867			SEC26-T05S-R25E
AMC 334785	CHE 14	492	869			SEC26-T05S-R25E
AMC 334786	CHE 15	492	871			SEC26-T05S-R25E
AMC 334787	CHE 16	492	873			SEC26-T05S-R25E
AMC 334788	CHE 17	492	875			SEC26-T05S-R25E
AMC 334789	CHE 18	492	877			SEC26-T05S-R25E
AMC 334790	CHE 19	492	879			SEC26-T05S-R25E
AMC 334791	CHE 20	492	881			SEC26-T05S-R25E
AMC 334792	CHE 21	492	883			SEC26-T05S-R25E
AMC 334793	CHE 22	492	885			SEC26-T05S-R25E
AMC 334794	CHE 23	492	887			SEC26-T05S-R25E
AMC 334795	CHE 24	492	889			SEC26-T05S-R25E
AMC 334796	CHE 25	492	891			SEC26-T05S-R25E
AMC 334797	CHE 26	492	893			SEC26-T05S-R25E
AMC 334798	CHE 27	492	895			SEC26-T05S-R25E
AMC 334799	CHE 28	492	897			SEC26-T05S-R25E
AMC 334800	CHE 29	492	899			SEC23-T05S-R25E
AMC 334801	CHE 30	492	901			SEC23-T05S-R25E
AMC 334802	CHE 31	492	903			SEC23-T05S-R25E
AMC 334803	CHE 32	492	905			SEC23-T05S-R25E
AMC 334804	CHE 33	492	907			SEC23-T05S-R25E
AMC 334805	CHE 34	492	909			SEC23-T05S-R25E
AMC 334806	CHE 35	492	911			SEC23-T05S-R25E
AMC 334807	CHE 36	492	913			SEC23-T05S-R25E
AMC 334808	CHE 37	492	915			SEC23-T05S-R25E
AMC 334809	CHE 38	492	917			SEC23-T05S-R25E
AMC 334810	CHE 39	492	919			SEC26-T05S-R25E
AMC 334811	CHE 40	492	921			SEC26-T05S-R25E
AMC 334812	CHE 41	492	923			SEC26-T05S-R25E
AMC 334813	CHE 42	492	925			SEC26-T05S-R25E
AMC 334814	CHE 43	492	927			SEC26-T05S-R25E
AMC 334815	CHE 44	492	929			SEC26-T05S-R25E
AMC 334816	CHE 45	492	931			SEC26-T05S-R25E
AMC 334817	CHE 46	492	933			SEC26-T05S-R25E
AMC 334818	CHE 47	492	935			SEC26-T05S-R25E
AMC 334819	CHE 48	492	937			SEC26-T05S-R25E

Date: 7/25/2016

RECEIVED  
 BLM AZ STATE OFFICE  
 PHOENIX, ARIZONA  
 AUG - 3 - 2016 9:22

## EXHIBIT A

County: Graham

State: AZ

BLM Serial #	Claim Name	Original Recording		Amended Recording		Location
		Recording #	Page #	Recording #	Page #	
AMC 334820	CHE 49	492	939			SEC26-T05S-R25E
AMC 334821	CHE 50	492	941			SEC26-T05S-R25E
AMC 334822	CHE 51	492	943			SEC26-T05S-R25E
AMC 334823	CHE 52	492	945			SEC26-T05S-R25E
AMC 334824	CHE 53	492	947			SEC26-T05S-R25E
AMC 334825	CHE 54	492	949			SEC26-T05S-R25E
AMC 334826	CHE 55	492	951			SEC26-T05S-R25E
AMC 334827	CHE 56	492	953			SEC26-T05S-R25E
AMC 340515	BH 21	510	117			SEC24-T05S-R26E
AMC 340539	Cliff 1R	510	1			SEC22-T05S-R26E
AMC 340540	Cliff 2R	510	3			SEC22-T05S-R26E
AMC 340541	Cliff 3R	510	5			SEC22-T05S-R26E
AMC 340542	Cliff 4R	510	7			SEC22-T05S-R26E
AMC 340543	Cliff 6R	510	9			SEC22-T05S-R26E
AMC 340544	Cliff 8R	510	11			SEC22-T05S-R26E
AMC 340545	Cliff 23R	510	13			SEC26-T05S-R26E
AMC 340546	Cliff 24R	510	15			SEC26-T05S-R26E
AMC 340547	Cliff 25R	510	17			SEC23-T05S-R26E
AMC 340548	Cliff 26R	510	19			SEC23-T05S-R26E
AMC 340549	Cliff 27R	510	21			SEC23-T05S-R26E
AMC 340550	Cliff 28R	510	23			SEC23-T05S-R26E
AMC 340551	Cliff 29R	510	25			SEC23-T05S-R26E
AMC 340552	Cliff 30R	510	27			SEC23-T05S-R26E
AMC 340553	Cliff 31R	510	29			SEC23-T05S-R26E
AMC 340554	Cliff 32R	510	31			SEC23-T05S-R26E
AMC 340558	Cliff 41R Amended	510	39	532	479	SEC23-T05S-R26E
AMC 340559	Cliff 42R Amended	510	41	532	751	SEC23-T05S-R26E
AMC 340560	Cliff 43R Amended	510	43	532	753	SEC23-T05S-R26E
AMC 340561	Cliff 44R Amended	510	45	532	755	SEC23-T05S-R26E
AMC 340562	Cliff 45	510	47			SEC23-T05S-R26E
AMC 340563	Cliff 46	510	49			SEC23-T05S-R26E
AMC 340564	Cliff 59	510	51			SEC23-T05S-R26E
AMC 340565	Cliff 60	510	53			SEC23-T05S-R26E
AMC 340566	Cliff 61	510	55			SEC23-T05S-R26E
AMC 340567	Cliff 62	510	57			SEC23-T05S-R26E
AMC 340568	Cliff 63	510	59			SEC23-T05S-R26E
AMC 340569	Cliff 64	510	61			SEC14-T05S-R26E
AMC 340570	Cliff 65	510	63			SEC14-T05S-R26E

Date: 7/25/2016

Page 30

RECEIVED  
 BLM AZ STATE OFFICE  
 2016 AUG - 3 A 9: 22  
 PHOENIX, ARIZONA

## EXHIBIT A

County: Graham

State: AZ

<u>BLM Serial #</u>	<u>Claim Name</u>	<u>Original Recording</u>		<u>Amended Recording</u>		<u>Location</u>
		<u>Recording #</u>	<u>Page #</u>	<u>Recording #</u>	<u>Page #</u>	
AMC 340956	SG 1	513	27			SEC20-T06S-R27E
AMC 340957	SG 2	513	29			SEC28-T06S-R27E
AMC 340958	SG 3	513	31			SEC29-T06S-R27E
AMC 340959	SG 4	513	33			SEC29-T06S-R27E
AMC 340960	SG 5	513	35			SEC29-T06S-R27E
AMC 340961	SG 6	513	37			SEC33-T06S-R27E
AMC 340962	SG 7	513	39			SEC33-T06S-R27E
AMC 340963	SG 8	513	41			SEC33-T06S-R27E
AMC 340964	SG 9	513	43			SEC04-T07S-R27E
AMC 340965	SG 10	513	45			SEC04-T07S-R27E
AMC 340966	SG 11	513	47			SEC04-T07S-R27E
AMC 340967	SG 12 Amended	513	49	525	947	SEC04-T07S-R27E
AMC 340968	SG 13	513	51			SEC04-T07S-R27E
AMC 340969	SG 14	513	53			SEC04-T07S-R27E
AMC 340970	SG 15	513	55			SEC33-T06S-R27E
AMC 340971	SG 16	513	57			SEC33-T06S-R27E
AMC 340972	SG 17	513	59			SEC33-T06S-R27E
AMC 340973	SG 18	513	61			SEC33-T06S-R27E
AMC 340974	SG 19	513	63			SEC33-T06S-R27E
AMC 340975	SG 20	513	65			SEC33-T06S-R27E
AMC 340976	SG 21	513	67			SEC34-T06S-R27E
AMC 340977	SG 22	513	69			SEC34-T06S-R27E
AMC 340978	SG 23	513	71			SEC27-T06S-R27E
AMC 340979	SG 24	513	73			SEC34-T06S-R27E
AMC 340980	SG 25	513	75			SEC34-T06S-R27E
AMC 340981	SG 26	513	77			SEC27-T06S-R27E
AMC 340982	SG 27	513	79			SEC27-T06S-R27E
AMC 340983	SG 28	513	81			SEC26-T06S-R27E
AMC 340984	SG 29	513	83			SEC27-T06S-R27E
AMC 340985	SG 30	513	85			SEC27-T06S-R27E
AMC 340986	SG 31	513	87			SEC26-T06S-R27E
AMC 340987	SG 32	513	89			SEC27-T06S-R27E
AMC 340988	SG 33	513	91			SEC27-T06S-R27E
AMC 340989	SG 34	513	93			SEC23-T06S-R27E
AMC 340990	SG 35	513	95			SEC23-T06S-R27E
AMC 340991	SG 36	513	97			SEC23-T06S-R27E
AMC 340992	SG 37	513	99			SEC23-T06S-R27E
AMC 340993	SG 38	513	101			SEC28-T06S-R27E

Date: 7/25/2016

Page 31

RECEIVED  
 BLM AZ STATE OFFICE  
 2016 AUG - 3 A 9: 22  
 CHOENIX, ARIZONA

## EXHIBIT A

County: Graham

State: AZ

BLM Serial #	Claim Name	Original Recording		Amended Recording		Location
		Recording #	Page #	Recording #	Page #	
AMC 340994	SG 39	513	103			SEC24-T06S-R27E
AMC 340995	SG 40	513	105			SEC25-T06S-R27E
AMC 340996	SG 41	513	107			SEC27-T06S-R27E
AMC 340997	SG 42	513	109			SEC28-T06S-R27E
AMC 340998	SG 43	513	111			SEC28-T06S-R27E
AMC 340999	SG 44	513	113			SEC23-T06S-R27E
AMC 341000	SG 45	513	115			SEC23-T06S-R27E
AMC 341001	SG 46	513	117			SEC25-T06S-R27E
AMC 341002	SZ 1	513	119			SEC29-T06S-R27E
AMC 341003	SZ 2	513	121			SEC29-T06S-R27E
AMC 341004	SZ 3	513	123			SEC29-T06S-R27E
AMC 341005	SZ 4	513	125			SEC29-T06S-R27E
AMC 341006	SZ 5	513	127			SEC29-T06S-R27E
AMC 341007	SZ 6	513	129			SEC29-T06S-R27E
AMC 341008	SZ 7	513	131			SEC29-T06S-R27E
AMC 341009	SZ 8	513	133			SEC29-T06S-R27E
AMC 341010	SZ 9	513	135			SEC29-T06S-R27E
AMC 341011	SZ 10	513	137			SEC29-T06S-R27E
AMC 341012	SZ 11	513	139			SEC29-T06S-R27E
AMC 341013	SZ 12	513	141			SEC29-T06S-R27E
AMC 341014	SZ 13	513	143			SEC29-T06S-R27E
AMC 341015	SZ 14	513	145			SEC20-T06S-R27E
AMC 341016	SZ 15	513	147			SEC20-T06S-R27E
AMC 341017	SZ 16	513	149			SEC20-T06S-R27E
AMC 341018	SZ 17	513	151			SEC20-T06S-R27E
AMC 341019	SZ 18	513	153			SEC20-T06S-R27E
AMC 341020	SZ 19	513	155			SEC20-T06S-R27E
AMC 341021	SZ 20	513	157			SEC20-T06S-R27E
AMC 341022	SZ 21	513	159			SEC20-T06S-R27E
AMC 341023	SZ 22	513	161			SEC20-T06S-R27E
AMC 341024	SZ 23	513	163			SEC20-T06S-R27E
AMC 341025	SZ 24	513	165			SEC20-T06S-R27E
AMC 341026	SZ 25	513	167			SEC20-T06S-R27E
AMC 341652	BH 4B	514	787			SEC26-T05S-R26E
AMC 341653	BH 6B	514	789			SEC26-T05S-R26E
AMC 341654	BH 8B	514	791			SEC26-T05S-R26E
AMC 341655	BH 10B	514	793			SEC25-T05S-R26E
AMC 341656	BH 12B	514	795			SEC25-T05S-R26E

Date: 7/25/2016

RECEIVED  
BLM AZ STATE OFFICE  
2016 AUG - 3 A 9 22

## EXHIBIT A

County: Graham

State: AZ

<u>BLM Serial #</u>	<u>Claim Name</u>	<u>Original Recording</u>		<u>Amended Recording</u>		<u>Location</u>
		<u>Recording #</u>	<u>Page #</u>	<u>Recording #</u>	<u>Page #</u>	
AMC 341657	BH 14B	514	797			SEC25-T05S-R26E
AMC 341658	BH 16B	514	799			SEC25-T05S-R26E
AMC 341659	BH 18B	514	801			SEC25-T05S-R26E
AMC 341660	BH 20B	514	803			SEC25-T05S-R26E
AMC 341661	BH 22B	514	805			SEC24-T05S-R26E
AMC 341662	BH 25B	514	807			SEC25-T05S-R26E
AMC 341663	BH 26B	514	809			SEC25-T05S-R26E
AMC 341664	BH 27B	514	811			SEC25-T05S-R26E
AMC 341665	BH 28B	514	813			SEC25-T05S-R26E
AMC 341666	BH 29B	514	815			SEC25-T05S-R26E
AMC 341667	BH 30B	514	817			SEC25-T05S-R26E
AMC 341668	BH 31B	514	819			SEC25-T05S-R26E
AMC 341669	BH 32B	514	821			SEC25-T05S-R26E
AMC 341670	BH 33B	514	823			SEC25-T05S-R26E
AMC 341671	BH 34B	514	825			SEC25-T05S-R26E
AMC 341672	BH 35B	514	827			SEC25-T05S-R26E
AMC 341673	BH 36B	514	829			SEC25-T05S-R26E
AMC 341674	BH 37B	514	831			SEC25-T05S-R26E
AMC 341675	BH 38B	514	833			SEC25-T05S-R26E
AMC 341676	BH 39B	514	835			SEC25-T05S-R26E
AMC 341677	BH 40B	514	837			SEC25-T05S-R26E
AMC 341678	BH 41B	514	839			SEC25-T05S-R26E
AMC 341679	BH 42B	514	841			SEC25-T05S-R26E
AMC 341680	BH 43B	514	843			SEC24-T05S-R26E
AMC 341681	BH 44B	514	845			SEC24-T05S-R26E
AMC 344109	SL 1	519	61			SEC26-T06S-R27E
AMC 344110	SL 2	519	63			SEC26-T06S-R27E
AMC 344111	SL 3	519	65			SEC26-T06S-R27E
AMC 344112	SL 4	519	67			SEC26-T06S-R27E
AMC 344113	SL 5	519	69			SEC26-T06S-R27E
AMC 344114	SL 6	519	71			SEC26-T06S-R27E
AMC 344115	SL 7	519	73			SEC25-T06S-R27E
AMC 344116	SG 47	519	75			SEC26-T06S-R27E
AMC 344117	SG 48	519	77			SEC26-T06S-R27E
AMC 344118	SG 49	519	79			SEC26-T06S-R27E
AMC 344119	SG 50	519	81			SEC23-T06S-R27E
AMC 344120	SG 51	519	83			SEC24-T06S-R27E
AMC 344121	SG 52	519	85			SEC24-T06S-R27E

Date: 7/25/2016

RECEIVED  
BLM AZ STATE OFFICE

PHOENIX, ARIZONA  
2016 AUG - 3 A 9: 22

# EXHIBIT A

County: Graham

State: AZ

<u>BLM Serial #</u>	<u>Claim Name</u>	<u>Original Recording</u>		<u>Amended Recording</u>		<u>Location</u>
		<u>Recording #</u>	<u>Page #</u>	<u>Recording #</u>	<u>Page #</u>	
AMC 344122	SG 53		519	419		SEC27-T06S-R27E
AMC 430691	ROCKSTAR 001	2015-1345				SEC01-T06S-R27E
AMC 430692	ROCKSTAR 002	2015-1346				SEC01-T06S-R27E
AMC 430693	ROCKSTAR 003	2015-1347				SEC01-T06S-R27E
AMC 430694	ROCKSTAR 004	2015-1348				SEC01-T06S-R27E
AMC 430695	ROCKSTAR 005	2015-1349				SEC01-T06S-R27E
AMC 430696	ROCKSTAR 006	2015-1350				SEC01-T06S-R27E
AMC 430697	ROCKSTAR 007	2015-1351				SEC01-T06S-R27E
AMC 430698	ROCKSTAR 008	2015-1352				SEC01-T06S-R27E
AMC 430699	ROCKSTAR 009	2015-1353				SEC01-T06S-R27E
AMC 430700	ROCKSTAR 010	2015-1354				SEC01-T06S-R27E
AMC 430701	ROCKSTAR 011	2015-1355				SEC01-T06S-R27E
AMC 430702	ROCKSTAR 012	2015-1356				SEC01-T06S-R27E
AMC 430703	ROCKSTAR 013	2015-1357				SEC01-T06S-R27E
AMC 430704	ROCKSTAR 014	2015-1358				SEC01-T06S-R27E
AMC 430705	ROCKSTAR 015	2015-1359				SEC01-T06S-R27E
AMC 430706	ROCKSTAR 016	2015-1360				SEC01-T06S-R27E
AMC 430707	ROCKSTAR 017	2015-1361				SEC01-T06S-R27E
AMC 430708	ROCKSTAR 018	2015-1362				SEC01-T06S-R27E
AMC 430709	ROCKSTAR 019	2015-1363				SEC01-T06S-R27E
AMC 430710	ROCKSTAR 020	2015-1364				SEC01-T06S-R27E
AMC 430711	ROCKSTAR 021	2015-1365				SEC01-T06S-R27E
AMC 430712	ROCKSTAR 022	2015-1366				SEC01-T06S-R27E
AMC 430713	ROCKSTAR 023	2015-1367				SEC01-T06S-R27E
AMC 430714	ROCKSTAR 024	2015-1368				SEC01-T06S-R27E
AMC 430715	ROCKSTAR 025	2015-1369				SEC01-T06S-R27E
AMC 430716	ROCKSTAR 026	2015-1370				SEC01-T06S-R27E
AMC 430717	ROCKSTAR 027	2015-1371				SEC01-T06S-R27E
AMC 430718	ROCKSTAR 028	2015-1372				SEC01-T06S-R27E
AMC 430719	ROCKSTAR 029	2015-1373				SEC01-T06S-R27E
AMC 430720	ROCKSTAR 030	2015-1374				SEC01-T06S-R27E
AMC 430721	ROCKSTAR 031	2015-1375				SEC01-T06S-R27E
AMC 430722	ROCKSTAR 032	2015-1376				SEC01-T06S-R27E
AMC 430723	ROCKSTAR 033	2015-1377				SEC01-T06S-R27E
AMC 430724	ROCKSTAR 034	2015-1378				SEC01-T06S-R27E
AMC 430725	ROCKSTAR 035	2015-1379				SEC01-T06S-R27E
AMC 430726	ROCKSTAR 036	2015-1380				SEC01-T06S-R27E
AMC 430751	ROCKSTAR 037	2015-1381				SEC02-T06S-R27E

Date: 7/25/2016

RECEIVED  
BLM AZ STATE OFFICE

2016 AUG - 3 A 9 22

PHOENIX, ARIZONA

# EXHIBIT A

County: Graham

State: AZ

<u>BLM Serial #</u>	<u>Claim Name</u>	<u>Original Recording</u>		<u>Amended Recording</u>		<u>Location</u>
		<u>Recording #</u>	<u>Page #</u>	<u>Recording #</u>	<u>Page #</u>	
AMC 430752	ROCKSTAR 038	2015-1382				SEC02-T06S-R27E
AMC 430753	ROCKSTAR 039	2015-1383				SEC02-T06S-R27E
AMC 430754	ROCKSTAR 040	2015-1384				SEC02-T06S-R27E
AMC 430755	ROCKSTAR 041	2015-1385				SEC02-T06S-R27E
AMC 430756	ROCKSTAR 042	2015-1386				SEC02-T06S-R27E
AMC 430757	ROCKSTAR 043	2015-1387				SEC02-T06S-R27E
AMC 430758	ROCKSTAR 044	2015-1388				SEC02-T06S-R27E
AMC 430759	ROCKSTAR 045	2015-1389				SEC02-T06S-R27E
AMC 430760	ROCKSTAR 046	2015-1390				SEC02-T06S-R27E
AMC 430761	ROCKSTAR 047	2015-1391				SEC02-T06S-R27E
AMC 430762	ROCKSTAR 048	2015-1392				SEC02-T06S-R27E
AMC 430763	ROCKSTAR 049	2015-1393				SEC02-T06S-R27E
AMC 430764	ROCKSTAR 050	2015-1394				SEC02-T06S-R27E
AMC 430765	ROCKSTAR 051	2015-1395				SEC02-T06S-R27E
AMC 430766	ROCKSTAR 052	2015-1396				SEC02-T06S-R27E
AMC 430767	ROCKSTAR 053	2015-1397				SEC02-T06S-R27E
AMC 430768	ROCKSTAR 054	2015-1398				SEC02-T06S-R27E
AMC 430769	ROCKSTAR 055	2015-1399				SEC02-T06S-R27E
AMC 430770	ROCKSTAR 056	2015-1400				SEC02-T06S-R27E
AMC 430771	ROCKSTAR 057	2015-1401				SEC02-T06S-R27E
AMC 430772	ROCKSTAR 058	2015-1402				SEC02-T06S-R27E
AMC 430773	ROCKSTAR 059	2015-1403				SEC02-T06S-R27E
AMC 430774	ROCKSTAR 060	2015-1404				SEC02-T06S-R27E
AMC 430775	ROCKSTAR 061	2015-1405				SEC02-T06S-R27E
AMC 430776	ROCKSTAR 062	2015-1406				SEC02-T06S-R27E
AMC 430777	ROCKSTAR 063	2015-1407				SEC02-T06S-R27E
AMC 430778	ROCKSTAR 064	2015-1408				SEC02-T06S-R27E
AMC 430779	ROCKSTAR 065	2015-1409				SEC02-T06S-R27E
AMC 430780	ROCKSTAR 066	2015-1410				SEC02-T06S-R27E
AMC 430781	ROCKSTAR 067	2015-1411				SEC02-T06S-R27E
AMC 430782	ROCKSTAR 068	2015-1412				SEC02-T06S-R27E
AMC 430783	ROCKSTAR 069	2015-1413				SEC02-T06S-R27E
AMC 430784	ROCKSTAR 070	2015-1414				SEC02-T06S-R27E
AMC 430785	ROCKSTAR 071	2015-1415				SEC02-T06S-R27E
AMC 430786	ROCKSTAR 072	2015-1416				SEC02-T06S-R27E
AMC 430787	ROCKSTAR 073	2015-1417				SEC02-T06S-R27E
AMC 430788	ROCKSTAR 074	2015-1418				SEC03-T06S-R27E
AMC 430789	ROCKSTAR 075	2015-1419				SEC03-T06S-R27E

Date: 7/25/2016

RECEIVED  
BLM AZ STATE OFFICE  
2016 AUG - 3 A 9 22  
PHOENIX, ARIZONA



# EXHIBIT A

County: Graham

State: AZ

<u>BLM Serial #</u>	<u>Claim Name</u>	<u>Original Recording</u>		<u>Amended Recording</u>		<u>Location</u>
		<u>Recording #</u>	<u>Page #</u>	<u>Recording #</u>	<u>Page #</u>	
AMC 430790	ROCKSTAR 076	2015-1420				SEC03-T06S-R27E
AMC 430791	ROCKSTAR 077	2015-1421				SEC03-T06S-R27E
AMC 430792	ROCKSTAR 078	2015-1422				SEC03-T06S-R27E
AMC 430793	ROCKSTAR 079	2015-1423				SEC03-T06S-R27E
AMC 430794	ROCKSTAR 080	2015-1424				SEC03-T06S-R27E
AMC 430795	ROCKSTAR 081	2015-1425				SEC03-T06S-R27E
AMC 430796	ROCKSTAR 082	2015-1426				SEC03-T06S-R27E
AMC 430797	ROCKSTAR 083	2015-1427				SEC03-T06S-R27E
AMC 430798	ROCKSTAR 084	2015-1428				SEC03-T06S-R27E
AMC 430799	ROCKSTAR 085	2015-1429				SEC03-T06S-R27E
AMC 430800	ROCKSTAR 086	2015-1430				SEC03-T06S-R27E
AMC 430801	ROCKSTAR 087	2015-1431				SEC03-T06S-R27E
AMC 430802	ROCKSTAR 088	2015-1432				SEC03-T06S-R27E
AMC 430803	ROCKSTAR 089	2015-1433				SEC03-T06S-R27E
AMC 430804	ROCKSTAR 090	2015-1434				SEC03-T06S-R27E
AMC 430805	ROCKSTAR 091	2015-1435				SEC12-T06S-R27E
AMC 430806	ROCKSTAR 092	2015-1436				SEC12-T06S-R27E
AMC 430807	ROCKSTAR 093	2015-1437				SEC12-T06S-R27E
AMC 430808	ROCKSTAR 094	2015-1438				SEC12-T06S-R27E
AMC 430809	ROCKSTAR 095	2015-1439				SEC12-T06S-R27E
AMC 430810	ROCKSTAR 096	2015-1440				SEC12-T06S-R27E
AMC 430811	ROCKSTAR 097	2015-1441				SEC12-T06S-R27E
AMC 430812	ROCKSTAR 098	2015-1442				SEC12-T06S-R27E
AMC 430813	ROCKSTAR 099	2015-1443				SEC12-T06S-R27E
AMC 430814	ROCKSTAR 100	2015-1444				SEC12-T06S-R27E
AMC 430815	ROCKSTAR 101	2015-1445				SEC12-T06S-R27E
AMC 430816	ROCKSTAR 102	2015-1446				SEC12-T06S-R27E
AMC 430817	ROCKSTAR 103	2015-1447				SEC12-T06S-R27E
AMC 430818	ROCKSTAR 104	2015-1448				SEC12-T06S-R27E
AMC 430819	ROCKSTAR 105	2015-1449				SEC12-T06S-R27E
AMC 430820	ROCKSTAR 106	2015-1450				SEC12-T06S-R27E
AMC 430821	ROCKSTAR 107	2015-1451				SEC12-T06S-R27E
AMC 430822	ROCKSTAR 108	2015-1452				SEC12-T06S-R27E
AMC 430823	ROCKSTAR 109	2015-1453				SEC12-T06S-R27E
AMC 430824	ROCKSTAR 110	2015-1454				SEC12-T06S-R27E
AMC 430825	ROCKSTAR 111	2015-1455				SEC12-T06S-R27E
AMC 430826	ROCKSTAR 112	2015-1456				SEC12-T06S-R27E
AMC 430827	ROCKSTAR 113	2015-1457				SEC12-T06S-R26E

Date: 7/25/2016

RECEIVED  
BLM AZ STATE OFFICE  
2016 AUG - 3 A 9 22  
PHOENIX, ARIZONA

## EXHIBIT A

County: Graham

State: AZ

<u>BLM Serial #</u>	<u>Claim Name</u>	<u>Original Recording</u>		<u>Amended Recording</u>		<u>Location</u>
		<u>Recording #</u>	<u>Page #</u>	<u>Recording #</u>	<u>Page #</u>	
AMC 430828	ROCKSTAR 114	2015-1458				SEC12-T06S-R26E
AMC 430829	ROCKSTAR 115	2015-1459				SEC12-T06S-R27E
AMC 430830	ROCKSTAR 116	2015-1460				SEC12-T06S-R27E
AMC 430831	ROCKSTAR 117	2015-1461				SEC12-T06S-R27E
AMC 430832	ROCKSTAR 118	2015-1462				SEC12-T06S-R27E
AMC 430833	ROCKSTAR 119	2015-1463				SEC12-T06S-R27E
AMC 430834	ROCKSTAR 120	2015-1464				SEC12-T06S-R27E
AMC 430835	ROCKSTAR 121	2015-1465				SEC12-T06S-R27E
AMC 430836	ROCKSTAR 122	2015-1466				SEC13-T06S-R27E
AMC 430889	Red Bull-1	2015-1696				SEC27-T05S-R25E
AMC 430890	Red Bull-2	2015-1697				SEC27-T05S-R25E
AMC 430891	Red Bull-3	2015-1698				SEC27-T05S-R25E
AMC 430892	Red Bull-4	2015-1699				SEC27-T05S-R25E
AMC 430893	Red Bull-5	2015-1700				SEC27-T05S-R25E
AMC 430894	Red Bull-6	2015-1701				SEC27-T05S-R25E
AMC 430895	Red Bull-7	2015-1702				SEC27-T05S-R25E
AMC 430896	Red Bull-8	2015-1703				SEC27-T05S-R25E
AMC 430897	Red Bull-9	2015-1704				SEC27-T05S-R25E
AMC 430898	Red Bull-10	2015-1705				SEC27-T05S-R25E
AMC 430899	Red Bull-11	2015-1706				SEC27-T05S-R25E
AMC 430900	Red Bull-12	2015-1707				SEC27-T05S-R25E
AMC 430901	Red Bull-13	2015-1708				SEC27-T05S-R25E
AMC 430902	Red Bull-14	2015-1709				SEC27-T05S-R25E
AMC 430903	Red Bull-15	2015-1710				SEC27-T05S-R25E
AMC 430904	Red Bull-16	2015-1711				SEC27-T05S-R25E
AMC 430905	Red Bull-17	2015-1712				SEC27-T05S-R25E
AMC 430906	Red Bull-18	2015-1713				SEC27-T05S-R25E
AMC 430907	Red Bull-19	2015-1714				SEC27-T05S-R25E
AMC 430908	Red Bull-20	2015-1715				SEC27-T05S-R25E
AMC 430909	Red Bull-21	2015-1716				SEC27-T05S-R25E
AMC 430910	Red Bull-22	2015-1717				SEC27-T05S-R25E
AMC 430911	Red Bull-23	2015-1718				SEC27-T05S-R25E
AMC 430912	Red Bull-24	2015-1719				SEC27-T05S-R25E
AMC 430913	Red Bull-25	2015-1720				SEC27-T05S-R25E
AMC 430914	Red Bull-26	2015-1721				SEC27-T05S-R25E
AMC 430915	Red Bull-27	2015-1722				SEC27-T05S-R25E
AMC 430916	Red Bull-28	2015-1723				SEC27-T05S-R25E
AMC 430917	Red Bull-29	2015-1724				SEC27-T05S-R25E

Date: 7/25/2016

Page 37

RECEIVED  
 BLM AZ STATE OFFICE  
 2016 AUG - 3 A 9 23  
 PHOENIX, ARIZONA

## EXHIBIT A

County: Graham

State: AZ

<u>BLM Serial #</u>	<u>Claim Name</u>	<u>Original Recording</u>		<u>Amended Recording</u>		<u>Location</u>
		<u>Recording #</u>	<u>Page #</u>	<u>Recording #</u>	<u>Page #</u>	
AMC 430918	Red Bull-30	2015-1725				SEC27-T05S-R25E
AMC 430919	Red Bull-31	2015-1726				SEC27-T05S-R25E
AMC 430920	Red Bull-32	2015-1727				SEC27-T05S-R25E
AMC 430921	Red Bull-33	2015-1728				SEC27-T05S-R25E
AMC 430922	Red Bull-34	2015-1729				SEC27-T05S-R25E
AMC 430923	Red Bull-35	2015-1730				SEC27-T05S-R25E
AMC 430924	Red Bull-36	2015-1731				SEC27-T05S-R25E
AMC 430925	Red Bull-37	2015-1732				SEC34-T05S-R25E
AMC 430926	Red Bull-38	2015-1733				SEC34-T05S-R25E
AMC 430927	Red Bull-39	2015-1734				SEC34-T05S-R25E
AMC 430928	Red Bull-40	2015-1735				SEC34-T05S-R25E
AMC 430929	Red Bull-41	2015-1736				SEC34-T05S-R25E
AMC 430930	Red Bull-42	2015-1737				SEC34-T05S-R25E
AMC 430931	Red Bull-43	2015-1738				SEC34-T05S-R25E
AMC 430932	Red Bull-44	2015-1739				SEC34-T05S-R25E
AMC 430933	Red Bull-45	2015-1740				SEC34-T05S-R25E
AMC 430934	Red Bull-46	2015-1741				SEC34-T05S-R25E
AMC 430935	Red Bull-47	2015-1742				SEC34-T05S-R25E
AMC 430936	Red Bull-48	2015-1743				SEC34-T05S-R25E
AMC 430937	Red Bull-49	2015-1744				SEC34-T05S-R25E
AMC 430938	Red Bull-50	2015-1745				SEC34-T05S-R25E
AMC 430939	Red Bull-51	2015-1746				SEC34-T05S-R25E
AMC 430940	Red Bull-52	2015-1747				SEC34-T05S-R25E
AMC 430941	Red Bull-53	2015-1748				SEC34-T05S-R25E
AMC 430942	Red Bull-54	2015-1749				SEC34-T05S-R25E
AMC 430943	Red Bull-55	2015-1750				SEC34-T05S-R25E
AMC 430944	Red Bull-56	2015-1751				SEC34-T05S-R25E
AMC 430945	Red Bull-57	2015-1752				SEC34-T05S-R25E
AMC 430946	Red Bull-58	2015-1753				SEC34-T05S-R25E
AMC 430947	Red Bull-59	2015-1754				SEC34-T05S-R25E
AMC 430948	Red Bull-60	2015-1755				SEC34-T05S-R25E
AMC 430949	Red Bull-61	2015-1756				SEC34-T05S-R25E
AMC 430950	Red Bull-62	2015-1757				SEC34-T05S-R25E
AMC 430951	Red Bull-63	2015-1758				SEC34-T05S-R25E
AMC 430952	Red Bull-64	2015-1759				SEC34-T05S-R25E
AMC 430953	Red Bull-65	2015-1760				SEC34-T05S-R25E
AMC 430954	Red Bull-66	2015-1761				SEC34-T05S-R25E
AMC 430955	Red Bull-67	2015-1762				SEC34-T05S-R25E

Date: 7/25/2016

Page 38

RECEIVED  
BLM AZ STATE OFFICE

PHOENIX, ARIZONA  
2016 AUG - 3 A 9:23

## EXHIBIT A

County: Graham

State: AZ

BLM Serial #	Claim Name	Original Recording		Amended Recording		Location
		Recording #	Page #	Recording #	Page #	
AMC 430956	Red Bull-68	2015-1763				SEC34-T05S-R25E
AMC 430957	Red Bull-69	2015-1764				SEC34-T05S-R25E
AMC 430958	Red Bull-70	2015-1765				SEC34-T05S-R25E
AMC 430959	Red Bull-71	2015-1766				SEC34-T05S-R25E
AMC 430960	Red Bull-72	2015-1767				SEC34-T05S-R25E
AMC 430961	Red Bull-73	2015-1768				SEC33-T05S-R25E
AMC 430962	Red Bull-74	2015-1769				SEC33-T05S-R25E
AMC 430963	Red Bull-75	2015-1770				SEC33-T05S-R25E
AMC 430964	Red Bull-76	2015-1771				SEC33-T05S-R25E
AMC 430965	Red Bull-77	2015-1772				SEC33-T05S-R25E
AMC 430966	Red Bull-78	2015-1773				SEC33-T05S-R25E
AMC 430967	Red Bull-79	2015-1774				SEC33-T05S-R25E
AMC 430968	Red Bull-80	2015-1775				SEC33-T05S-R25E
AMC 430969	Red Bull-81	2015-1776				SEC33-T05S-R25E
AMC 430970	Red Bull-82	2015-1777				SEC33-T05S-R25E
AMC 430971	Red Bull-83	2015-1778				SEC33-T05S-R25E
AMC 430972	Red Bull-84	2015-1779				SEC33-T05S-R25E
AMC 430973	Red Bull-85	2015-1780				SEC33-T05S-R25E
AMC 430974	Red Bull-86	2015-1781				SEC33-T05S-R25E
AMC 430975	Red Bull-87	2015-1782				SEC33-T05S-R25E
AMC 430976	Red Bull-88	2015-1783				SEC33-T05S-R25E
AMC 430977	Red Bull-89	2015-1784				SEC33-T05S-R25E
AMC 430978	Red Bull-90	2015-1785				SEC33-T05S-R25E
AMC 430979	Red Bull-91	2015-1786				SEC33-T05S-R25E
AMC 430980	Red Bull-92	2015-1787				SEC33-T05S-R25E
AMC 430981	Red Bull-93	2015-1788				SEC33-T05S-R25E
AMC 430982	Red Bull-94	2015-1789				SEC33-T05S-R25E
AMC 430983	Red Bull-95	2015-1790				SEC33-T05S-R25E
AMC 430984	Red Bull-96	2015-1791				SEC33-T05S-R25E
AMC 430985	Red Bull-97	2015-1792				SEC33-T05S-R25E
AMC 430986	Red Bull-98	2015-1793				SEC33-T05S-R25E
AMC 430987	Red Bull-99	2015-1794				SEC33-T05S-R25E
AMC 430988	Red Bull-100	2015-1795				SEC33-T05S-R25E
AMC 430989	Red Bull-101	2015-1796				SEC33-T05S-R25E
AMC 430990	Red Bull-102	2015-1797				SEC33-T05S-R25E
AMC 430991	Red Bull-103	2015-1798				SEC33-T05S-R25E
AMC 430992	Red Bull-104	2015-1799				SEC33-T05S-R25E
AMC 430993	Red Bull-105	2015-1800				SEC33-T05S-R25E

Date: 7/25/2016

Page 39

RECEIVED  
BLM AZ STATE OFFICE  
2016 AUG - 3 A 9: 23  
PHOENIX, ARIZONA

## EXHIBIT A

County: Graham

State: AZ

<u>BLM Serial #</u>	<u>Claim Name</u>	<u>Original Recording</u>		<u>Amended Recording</u>		<u>Location</u>
		<u>Recording #</u>	<u>Page #</u>	<u>Recording #</u>	<u>Page #</u>	
AMC 430994	Red Bull-106	2015-1801				SEC33-T05S-R25E
AMC 430995	Red Bull-107	2015-1802				SEC33-T05S-R25E
AMC 430996	Red Bull-108	2015-1803				SEC33-T05S-R25E
AMC 430997	Red Bull-109	2015-1804				SEC28-T05S-R25E
AMC 430998	Red Bull-110	2015-1805				SEC28-T05S-R25E
AMC 430999	Red Bull-111	2015-1806				SEC28-T05S-R25E
AMC 431000	Red Bull-112	2015-1807				SEC28-T05S-R25E
AMC 431001	Red Bull-113	2015-1808				SEC28-T05S-R25E
AMC 431002	Red Bull-114	2015-1809				SEC28-T05S-R25E
AMC 431003	Red Bull-115	2015-1810				SEC28-T05S-R25E
AMC 431004	Red Bull-116	2015-1811				SEC28-T05S-R25E
AMC 431005	Red Bull-117	2015-1812				SEC28-T05S-R25E
AMC 431006	Red Bull-118	2015-1813				SEC28-T05S-R25E
AMC 431007	Red Bull-119	2015-1814				SEC28-T05S-R25E
AMC 431008	Red Bull-120	2015-1815				SEC28-T05S-R25E
AMC 431009	Red Bull-121	2015-1816				SEC28-T05S-R25E
AMC 431010	Red Bull-122	2015-1817				SEC28-T05S-R25E
AMC 431011	Red Bull-123	2015-1818				SEC28-T05S-R25E
AMC 431012	Red Bull-124	2015-1819				SEC28-T05S-R25E
AMC 431013	Red Bull-125	2015-1820				SEC28-T05S-R25E
AMC 431014	Red Bull-126	2015-1821				SEC28-T05S-R25E
AMC 431015	Red Bull-127	2015-1822				SEC28-T05S-R25E
AMC 431016	Red Bull-128	2015-1823				SEC28-T05S-R25E
AMC 431017	Red Bull-129	2015-1824				SEC28-T05S-R25E
AMC 431018	Red Bull-130	2015-1825				SEC28-T05S-R25E
AMC 431019	Red Bull-131	2015-1826				SEC28-T05S-R25E
AMC 431020	Red Bull-132	2015-1827				SEC28-T05S-R25E
AMC 431021	Red Bull-133	2015-1828				SEC28-T05S-R25E
AMC 431022	Red Bull-134	2015-1829				SEC28-T05S-R25E
AMC 431023	Red Bull-135	2015-1830				SEC28-T05S-R25E
AMC 431024	Red Bull-136	2015-1831				SEC28-T05S-R25E
AMC 431025	Red Bull-137	2015-1832				SEC28-T05S-R25E
AMC 431026	Red Bull-138	2015-1833				SEC28-T05S-R25E
AMC 431027	Red Bull-139	2015-1834				SEC28-T05S-R25E
AMC 431028	Red Bull-140	2015-1835				SEC28-T05S-R25E
AMC 431029	Red Bull-141	2015-1836				SEC28-T05S-R25E
AMC 431030	Red Bull-142	2015-1837				SEC28-T05S-R25E
AMC 431031	Red Bull-143	2015-1838				SEC28-T05S-R25E

Date: 7/25/2016

Page 40

RECEIVED  
BLM AZ STATE OFFICE  
2016 AUG - 3 A 9: 23  
PHOENIX, ARIZONA

## EXHIBIT A

County: Graham

State: AZ

<u>BLM Serial #</u>	<u>Claim Name</u>	<u>Original Recording</u>		<u>Amended Recording</u>		<u>Location</u>
		<u>Recording #</u>	<u>Page #</u>	<u>Recording #</u>	<u>Page #</u>	
AMC 431032	Red Bull-144	2015-1839				SEC28-T05S-R25E
AMC 431033	Red Bull-316	2015-1840				SEC16-T05S-R25E
AMC 431034	Red Bull-317	2015-1841				SEC16-T05S-R25E
AMC 431035	Red Bull-318	2015-1842				SEC16-T05S-R25E
AMC 431036	Red Bull-319	2015-1843				SEC16-T05S-R25E
AMC 431037	Red Bull-320	2015-1844				SEC16-T05S-R25E
AMC 431038	Red Bull-321	2015-1845				SEC16-T05S-R25E
AMC 431039	Red Bull-322	2015-1846				SEC16-T05S-R25E
AMC 431040	Red Bull-323	2015-1847				SEC16-T05S-R25E
AMC 431041	Red Bull-324	2015-1848				SEC16-T05S-R25E
AMC 431042	Red Bull-325	2015-1849				SEC16-T05S-R25E
AMC 431043	Red Bull-326	2015-1850				SEC16-T05S-R25E
AMC 431044	Red Bull-327	2015-1851				SEC16-T05S-R25E
AMC 431045	Red Bull-328	2015-1852				SEC16-T05S-R25E
AMC 431046	Red Bull-329	2015-1853				SEC16-T05S-R25E
AMC 431047	Red Bull-330	2015-1854				SEC16-T05S-R25E
AMC 431048	Red Bull-331	2015-1855				SEC16-T05S-R25E
AMC 431049	Red Bull-332	2015-1856				SEC16-T05S-R25E
AMC 431050	Red Bull-333	2015-1857				SEC16-T05S-R25E
AMC 431051	Red Bull-334	2015-1858				SEC16-T05S-R25E
AMC 431052	Red Bull-335	2015-1859				SEC16-T05S-R25E
AMC 431053	Red Bull-336	2015-1860				SEC16-T05S-R25E
AMC 431054	Red Bull-337	2015-1861				SEC16-T05S-R25E
AMC 431055	Red Bull-338	2015-1862				SEC16-T05S-R25E
AMC 431056	Red Bull-339	2015-1863				SEC16-T05S-R25E
AMC 431057	Red Bull-340	2015-1864				SEC16-T05S-R25E
AMC 431058	Red Bull-341	2015-1865				SEC16-T05S-R25E
AMC 431059	Red Bull-342	2015-1866				SEC16-T05S-R25E
AMC 431060	Red Bull-343	2015-1867				SEC16-T05S-R25E
AMC 431061	Red Bull-344	2015-1868				SEC16-T05S-R25E
AMC 431062	Red Bull-345	2015-1869				SEC16-T05S-R25E
AMC 431063	Red Bull-346	2015-1870				SEC16-T05S-R25E
AMC 431064	Red Bull-347	2015-1871				SEC16-T05S-R25E
AMC 431065	Red Bull-348	2015-1872				SEC16-T05S-R25E
AMC 431066	Red Bull-349	2015-1873				SEC16-T05S-R25E
AMC 431067	Red Bull-350	2015-1874				SEC16-T05S-R25E
AMC 431068	Red Bull-351	2015-1875				SEC16-T05S-R25E
AMC 431071	ROCKSTAR 123	2015-1913				SEC13-T06S-R27E

Date: 7/25/2016

Page 41

RECEIVED  
BLM AZ STATE OFFICE

PHOENIX, ARIZONA  
2016 AUG - 3 A 9: 23

## EXHIBIT A

County: Graham

State: AZ

<u>BLM Serial #</u>	<u>Claim Name</u>	<u>Original Recording</u>		<u>Amended Recording</u>		<u>Location</u>
		<u>Recording #</u>	<u>Page #</u>	<u>Recording #</u>	<u>Page #</u>	
AMC 431072	ROCKSTAR 124	2015-1914				SEC13-T06S-R27E
AMC 431073	ROCKSTAR 125	2015-1915				SEC13-T06S-R27E
AMC 431074	ROCKSTAR 126	2015-1916				SEC24-T06S-R27E
AMC 431075	ROCKSTAR 127	2015-1917				SEC13-T06S-R27E
AMC 431076	ROCKSTAR 128	2015-1918				SEC13-T06S-R27E
AMC 431077	ROCKSTAR 129	2015-1919				SEC13-T06S-R27E
AMC 431078	ROCKSTAR 130	2015-1920				SEC13-T06S-R27E
AMC 431079	ROCKSTAR 131	2015-1921				SEC13-T06S-R27E
AMC 431080	ROCKSTAR 132	2015-1922				SEC13-T06S-R27E
AMC 431081	ROCKSTAR 133	2015-1923				SEC13-T06S-R27E
AMC 431082	ROCKSTAR 134	2015-1924				SEC13-T06S-R27E
AMC 431083	ROCKSTAR 135	2015-1925				SEC13-T06S-R27E
AMC 431084	ROCKSTAR 136	2015-1926				SEC13-T06S-R27E
AMC 431085	ROCKSTAR 137	2015-1927				SEC13-T06S-R27E
AMC 431086	ROCKSTAR 138	2015-1928				SEC13-T06S-R27E
AMC 431087	ROCKSTAR 139	2015-1929				SEC13-T06S-R27E
AMC 431088	ROCKSTAR 140	2015-1930				SEC13-T06S-R27E
AMC 431089	ROCKSTAR 141	2015-1931				SEC13-T06S-R27E
AMC 431090	ROCKSTAR 142	2015-1932				SEC13-T06S-R27E
AMC 431091	ROCKSTAR 143	2015-1933				SEC13-T06S-R27E
AMC 431092	ROCKSTAR 144	2015-1934				SEC13-T06S-R27E
AMC 431093	ROCKSTAR 145	2015-1935				SEC13-T06S-R27E
AMC 431094	ROCKSTAR 146	2015-1936				SEC13-T06S-R27E
AMC 431095	ROCKSTAR 147	2015-1937				SEC13-T06S-R27E
AMC 431096	ROCKSTAR 148	2015-1938				SEC13-T06S-R27E
AMC 431097	ROCKSTAR 149	2015-1939				SEC13-T06S-R27E
AMC 431098	ROCKSTAR 150	2015-1940				SEC13-T06S-R27E
AMC 431099	ROCKSTAR 151	2015-1941				SEC24-T06S-R27E
AMC 431100	ROCKSTAR 152	2015-1942				SEC24-T06S-R27E
AMC 431101	ROCKSTAR 153	2015-1943				SEC24-T06S-R27E
AMC 431102	ROCKSTAR 154	2015-1944				SEC24-T06S-R27E
AMC 431103	ROCKSTAR 155	2015-1945				SEC24-T06S-R27E
AMC 431104	ROCKSTAR 156	2015-1946				SEC24-T06S-R27E
AMC 431105	ROCKSTAR 157	2015-1947				SEC24-T06S-R27E
AMC 431106	ROCKSTAR 158	2015-1948				SEC24-T06S-R27E
AMC 431107	ROCKSTAR 159	2015-1949				SEC24-T06S-R27E
AMC 431108	ROCKSTAR 160	2015-1950				SEC24-T06S-R27E
AMC 431109	ROCKSTAR 161	2015-1951				SEC24-T06S-R27E

Date: 7/25/2016

Page 42

RECEIVED  
BLM AZ STATE OFFICE  
2016 AUG - 3 A 9: 23  
PHOENIX, ARIZONA

## EXHIBIT A

County: Graham

State: AZ

<u>BLM Serial #</u>	<u>Claim Name</u>	<u>Original Recording</u>		<u>Amended Recording</u>		<u>Location</u>
		<u>Recording #</u>	<u>Page #</u>	<u>Recording #</u>	<u>Page #</u>	
AMC 431110	ROCKSTAR 162	2015-1952				SEC24-T06S-R27E
AMC 431111	ROCKSTAR 163	2015-1953				SEC24-T06S-R27E
AMC 431112	ROCKSTAR 164	2015-1954				SEC24-T06S-R27E
AMC 431113	ROCKSTAR 165	2015-1955				SEC24-T06S-R27E
AMC 431114	ROCKSTAR 166	2015-1956				SEC24-T06S-R27E
AMC 431115	ROCKSTAR 167	2015-1957				SEC24-T06S-R27E
AMC 431116	ROCKSTAR 168	2015-1958				SEC24-T06S-R27E
AMC 431117	ROCKSTAR 169	2015-1959				SEC24-T06S-R27E
AMC 431118	ROCKSTAR 170	2015-1960				SEC24-T06S-R27E
AMC 431119	ROCKSTAR 171	2015-1961				SEC24-T06S-R27E
AMC 431120	ROCKSTAR 172	2015-1962				SEC23-T06S-R27E
AMC 431121	MONSTER-001	2015-1963				SEC30-T05S-R27E
AMC 431122	MONSTER-002	2015-1964				SEC30-T05S-R27E
AMC 431123	MONSTER-003	2015-1965				SEC30-T05S-R27E
AMC 431124	MONSTER-004	2015-1966				SEC30-T05S-R27E
AMC 431125	MONSTER-005	2015-1967				SEC30-T05S-R27E
AMC 431126	MONSTER-006	2015-1968				SEC30-T05S-R27E
AMC 431127	MONSTER-007	2015-1969				SEC30-T05S-R27E
AMC 431128	MONSTER-008	2015-1970				SEC30-T05S-R27E
AMC 431129	MONSTER-009	2015-1971				SEC30-T05S-R27E
AMC 431130	MONSTER-010	2015-1972				SEC30-T05S-R27E
AMC 431131	MONSTER-011	2015-1973				SEC30-T05S-R27E
AMC 431132	MONSTER-012	2015-1974				SEC30-T05S-R27E
AMC 431133	MONSTER-013	2015-1975				SEC30-T05S-R27E
AMC 431134	MONSTER-014	2015-1976				SEC30-T05S-R27E
AMC 431135	MONSTER-015	2015-1977				SEC30-T05S-R27E
AMC 431136	MONSTER-016	2015-1978				SEC30-T05S-R27E
AMC 431137	MONSTER-017	2015-1979				SEC30-T05S-R27E
AMC 431138	MONSTER-018	2015-1980				SEC30-T05S-R27E
AMC 431139	MONSTER-019	2015-1981				SEC30-T05S-R27E
AMC 431140	MONSTER-020	2015-1982				SEC30-T05S-R27E
AMC 431141	MONSTER-021	2015-1983				SEC30-T05S-R27E
AMC 431142	MONSTER-022	2015-1984				SEC30-T05S-R27E
AMC 431143	MONSTER-023	2015-1985				SEC30-T05S-R27E
AMC 431144	MONSTER-024	2015-1986				SEC30-T05S-R27E
AMC 431145	MONSTER-025	2015-1987				SEC30-T05S-R27E
AMC 431146	MONSTER-026	2015-1988				SEC30-T05S-R27E
AMC 431147	MONSTER-027	2015-1989				SEC30-T05S-R27E

Date: 7/25/2016

RECEIVED  
BLM AZ STATE OFFICE



## EXHIBIT A

County: Graham

State: AZ

<u>BLM Serial #</u>	<u>Claim Name</u>	<u>Original Recording</u>		<u>Amended Recording</u>		<u>Location</u>
		<u>Recording #</u>	<u>Page #</u>	<u>Recording #</u>	<u>Page #</u>	
AMC 431148	MONSTER-028	2015-1990				SEC30-T05S-R27E
AMC 431149	MONSTER-029	2015-1991				SEC30-T05S-R27E
AMC 431150	MONSTER-030	2015-1992				SEC30-T05S-R27E
AMC 431151	MONSTER-031	2015-1993				SEC30-T05S-R27E
AMC 431152	MONSTER-032	2015-1994				SEC30-T05S-R27E
AMC 431153	MONSTER-033	2015-1995				SEC30-T05S-R27E
AMC 431154	MONSTER-034	2015-1996				SEC30-T05S-R27E
AMC 431155	MONSTER-035	2015-1997				SEC30-T05S-R27E
AMC 431156	MONSTER-036	2015-1998				SEC30-T05S-R27E
AMC 431157	MONSTER-037	2015-1999				SEC29-T05S-R27E
AMC 431158	MONSTER-038	2015-2000				SEC29-T05S-R27E
AMC 431159	MONSTER-039	2015-2001				SEC29-T05S-R27E
AMC 431160	MONSTER-040	2015-2002				SEC29-T05S-R27E
AMC 431161	MONSTER-041	2015-2003				SEC29-T05S-R27E
AMC 431162	MONSTER-042	2015-2004				SEC29-T05S-R27E
AMC 431163	MONSTER-043	2015-2005				SEC29-T05S-R27E
AMC 431164	MONSTER-044	2015-2006				SEC29-T05S-R27E
AMC 431165	MONSTER-045	2015-2007				SEC29-T05S-R27E
AMC 431166	MONSTER-046	2015-2008				SEC29-T05S-R27E
AMC 431167	MONSTER-047	2015-2009				SEC29-T05S-R27E
AMC 431168	MONSTER-048	2015-2010				SEC29-T05S-R27E
AMC 431169	MONSTER-049	2015-2011				SEC29-T05S-R27E
AMC 431170	MONSTER-050	2015-2012				SEC29-T05S-R27E
AMC 431171	MONSTER-051	2015-2013				SEC29-T05S-R27E
AMC 431172	MONSTER-052	2015-2014				SEC29-T05S-R27E
AMC 431173	MONSTER-053	2015-2015				SEC29-T05S-R27E
AMC 431174	MONSTER-054	2015-2016				SEC29-T05S-R27E
AMC 431175	MONSTER-055	2015-2017				SEC29-T05S-R27E
AMC 431176	MONSTER-056	2015-2018				SEC29-T05S-R27E
AMC 431177	MONSTER-057	2015-2019				SEC29-T05S-R27E
AMC 431178	MONSTER-058	2015-2020				SEC29-T05S-R27E
AMC 431179	MONSTER-059	2015-2021				SEC29-T05S-R27E
AMC 431180	MONSTER-060	2015-2022				SEC29-T05S-R27E
AMC 431181	MONSTER-061	2015-2023				SEC29-T05S-R27E
AMC 431182	MONSTER-062	2015-2024				SEC29-T05S-R27E
AMC 431183	MONSTER-063	2015-2025				SEC29-T05S-R27E
AMC 431184	MONSTER-064	2015-2026				SEC29-T05S-R27E
AMC 431185	MONSTER-065	2015-2027				SEC29-T05S-R27E

Date: 7/25/2016

Page 44

RECEIVED  
 BLM AZ STATE OFFICE  
 2016 AUG - 3 A 9:23  
 PHOENIX, ARIZONA

## EXHIBIT A

County: Graham

State: AZ

<u>BLM Serial #</u>	<u>Claim Name</u>	<u>Original Recording</u>		<u>Amended Recording</u>		<u>Location</u>
		<u>Recording #</u>	<u>Page #</u>	<u>Recording #</u>	<u>Page #</u>	
AMC 431186	MONSTER-066	2015-2028				SEC29-T05S-R27E
AMC 431187	MONSTER-067	2015-2029				SEC29-T05S-R27E
AMC 431188	MONSTER-068	2015-2030				SEC29-T05S-R27E
AMC 431189	MONSTER-069	2015-2031				SEC29-T05S-R27E
AMC 431190	MONSTER-070	2015-2032				SEC29-T05S-R27E
AMC 431191	MONSTER-071	2015-2033				SEC29-T05S-R27E
AMC 431192	MONSTER-072	2015-2034				SEC29-T05S-R27E
AMC 431193	MONSTER-073	2015-2035				SEC28-T05S-R27E
AMC 431194	MONSTER-074	2015-2036				SEC28-T05S-R27E
AMC 431195	MONSTER-075	2015-2037				SEC28-T05S-R27E
AMC 431196	MONSTER-076	2015-2038				SEC28-T05S-R27E
AMC 431197	MONSTER-077	2015-2039				SEC28-T05S-R27E
AMC 431198	MONSTER-078	2015-2040				SEC28-T05S-R27E
AMC 431199	MONSTER-079	2015-2041				SEC28-T05S-R27E
AMC 431200	MONSTER-080	2015-2042				SEC28-T05S-R27E
AMC 431201	MONSTER-081	2015-2043				SEC28-T05S-R27E
AMC 431202	MONSTER-082	2015-2044				SEC28-T05S-R27E
AMC 431203	MONSTER-083	2015-2045				SEC28-T05S-R27E
AMC 431204	MONSTER-084	2015-2046				SEC28-T05S-R27E
AMC 431205	MONSTER-085	2015-2047				SEC28-T05S-R27E
AMC 431206	MONSTER-086	2015-2048				SEC28-T05S-R27E
AMC 431207	MONSTER-087	2015-2049				SEC28-T05S-R27E
AMC 431208	MONSTER-088	2015-2050				SEC28-T05S-R27E
AMC 431209	MONSTER-089	2015-2051				SEC28-T05S-R27E
AMC 431210	MONSTER-090	2015-2052				SEC28-T05S-R27E
AMC 431211	MONSTER-091	2015-2053				SEC28-T05S-R27E
AMC 431212	MONSTER-092	2015-2054				SEC28-T05S-R27E
AMC 431213	MONSTER-093	2015-2055				SEC28-T05S-R27E
AMC 431214	MONSTER-094	2015-2056				SEC28-T05S-R27E
AMC 431215	MONSTER-095	2015-2057				SEC28-T05S-R27E
AMC 431216	MONSTER-096	2015-2058				SEC28-T05S-R27E
AMC 431217	MONSTER-097	2015-2059				SEC28-T05S-R27E
AMC 431218	MONSTER-098	2015-2060				SEC28-T05S-R27E
AMC 431219	MONSTER-099	2015-2061				SEC28-T05S-R27E
AMC 431220	MONSTER-100	2015-2062				SEC28-T05S-R27E
AMC 431221	MONSTER-101	2015-2063				SEC28-T05S-R27E
AMC 431222	MONSTER-102	2015-2064				SEC28-T05S-R27E
AMC 431223	MONSTER-103	2015-2065				SEC28-T05S-R27E

Date: 7/25/2016

RECEIVED  
BLM AZ STATE OFFICE  
2016 AUG - 3 A 9 29

## EXHIBIT A

County: Graham

State: AZ

BLM Serial #	Claim Name	Original Recording		Amended Recording		Location
		Recording #	Page #	Recording #	Page #	
AMC 431224	MONSTER-104	2015-2066				SEC28-T05S-R27E
AMC 431225	MONSTER-105	2015-2067				SEC28-T05S-R27E
AMC 431226	MONSTER-106	2015-2068				SEC28-T05S-R27E
AMC 431227	MONSTER-107	2015-2069				SEC28-T05S-R27E
AMC 431228	MONSTER-108	2015-2070				SEC28-T05S-R27E
AMC 431229	MONSTER-149	2015-2071				SEC34-T05S-R27E
AMC 431230	MONSTER-150	2015-2072				SEC34-T05S-R27E
AMC 431231	MONSTER-159	2015-2073				SEC34-T05S-R27E
AMC 431232	MONSTER-160	2015-2074				SEC34-T05S-R27E
AMC 431233	MONSTER-161	2015-2075				SEC34-T05S-R27E
AMC 431234	MONSTER-162	2015-2076				SEC34-T05S-R27E
AMC 431235	MONSTER-163	2015-2077				SEC34-T05S-R27E
AMC 431236	MONSTER-164	2015-2078				SEC34-T05S-R27E
AMC 431237	MONSTER-165	2015-2079				SEC34-T05S-R27E
AMC 431238	MONSTER-166	2015-2080				SEC34-T05S-R27E
AMC 431239	MONSTER-167	2015-2081				SEC34-T05S-R27E
AMC 431240	MONSTER-168	2015-2082				SEC34-T05S-R27E
AMC 431241	MONSTER-169	2015-2083				SEC34-T05S-R27E
AMC 431242	MONSTER-170	2015-2084				SEC34-T05S-R27E
AMC 431243	MONSTER-171	2015-2085				SEC34-T05S-R27E
AMC 431244	MONSTER-172	2015-2086				SEC34-T05S-R27E
AMC 431245	MONSTER-173	2015-2087				SEC34-T05S-R27E
AMC 431246	MONSTER-174	2015-2088				SEC34-T05S-R27E
AMC 431247	MONSTER-175	2015-2089				SEC34-T05S-R27E
AMC 431248	MONSTER-176	2015-2090				SEC34-T05S-R27E
AMC 431249	MONSTER-331	2015-2091				SEC19-T05S-R27E
AMC 431250	MONSTER-332	2015-2092				SEC19-T05S-R27E
AMC 431251	MONSTER-333	2015-2093				SEC19-T05S-R27E
AMC 431252	MONSTER-334	2015-2094				SEC19-T05S-R27E
AMC 431253	MONSTER-335	2015-2095				SEC19-T05S-R27E
AMC 431254	MONSTER-336	2015-2096				SEC19-T05S-R27E
AMC 431255	MONSTER-337	2015-2097				SEC19-T05S-R27E
AMC 431256	MONSTER-338	2015-2098				SEC19-T05S-R27E
AMC 431257	MONSTER-339	2015-2099				SEC19-T05S-R27E
AMC 431258	MONSTER-340	2015-2100				SEC19-T05S-R27E
AMC 431259	MONSTER-341	2015-2101				SEC19-T05S-R27E
AMC 431260	MONSTER-342	2015-2102				SEC19-T05S-R27E
AMC 431261	MONSTER-343	2015-2103				SEC19-T05S-R27E

Date: 7/25/2016

RECEIVED  
BLM AZ STATE OFFICE  
2016 AUG - 3 A 9 22  
PHOENIX, ARIZONA

## EXHIBIT A

County: Graham

State: AZ

<u>BLM Serial #</u>	<u>Claim Name</u>	<u>Original Recording</u>		<u>Amended Recording</u>		<u>Location</u>
		<u>Recording #</u>	<u>Page #</u>	<u>Recording #</u>	<u>Page #</u>	
AMC 431262	MONSTER-344	2015-2104				SEC19-T05S-R27E
AMC 431263	MONSTER-345	2015-2105				SEC19-T05S-R27E
AMC 431264	MONSTER-346	2015-2106				SEC19-T05S-R27E
AMC 431265	MONSTER-347	2015-2107				SEC19-T05S-R27E
AMC 431266	MONSTER-348	2015-2108				SEC19-T05S-R27E
AMC 431267	MONSTER-349	2015-2109				SEC19-T05S-R27E
AMC 431268	MONSTER-350	2015-2110				SEC19-T05S-R27E
AMC 431269	MONSTER-351	2015-2111				SEC19-T05S-R27E
AMC 431270	MONSTER-352	2015-2112				SEC19-T05S-R27E
AMC 431271	MONSTER-353	2015-2113				SEC19-T05S-R27E
AMC 431272	MONSTER-354	2015-2114				SEC19-T05S-R27E
AMC 431273	MONSTER-355	2015-2115				SEC19-T05S-R27E
AMC 431274	MONSTER-356	2015-2116				SEC19-T05S-R27E
AMC 431275	MONSTER-357	2015-2117				SEC19-T05S-R27E
AMC 431276	MONSTER-358	2015-2118				SEC19-T05S-R27E
AMC 431277	MONSTER-359	2015-2119				SEC19-T05S-R27E
AMC 431278	MONSTER-360	2015-2120				SEC19-T05S-R27E
AMC 431279	MONSTER-361	2015-2121				SEC19-T05S-R27E
AMC 431280	MONSTER-362	2015-2122				SEC19-T05S-R27E
AMC 431281	MONSTER-363	2015-2123				SEC19-T05S-R27E
AMC 431282	MONSTER-364	2015-2124				SEC19-T05S-R27E
AMC 431283	MONSTER-365	2015-2125				SEC19-T05S-R27E
AMC 431284	MONSTER-366	2015-2126				SEC19-T05S-R27E
AMC 431317	Red Bull-145	2015-2200				SEC29-T05S-R25E
AMC 431318	Red Bull-146	2015-2201				SEC29-T05S-R25E
AMC 431319	Red Bull-147	2015-2202				SEC29-T05S-R25E
AMC 431320	Red Bull-148	2015-2203				SEC29-T05S-R25E
AMC 431321	Red Bull-149	2015-2204				SEC29-T05S-R25E
AMC 431322	Red Bull-150	2015-2205				SEC29-T05S-R25E
AMC 431323	Red Bull-151	2015-2206				SEC29-T05S-R25E
AMC 431324	Red Bull-152	2015-2207				SEC29-T05S-R25E
AMC 431325	Red Bull-153	2015-2208				SEC29-T05S-R25E
AMC 431326	Red Bull-154	2015-2209				SEC29-T05S-R25E
AMC 431327	Red Bull-155	2015-2210				SEC29-T05S-R25E
AMC 431328	Red Bull-156	2015-2211				SEC29-T05S-R25E
AMC 431329	Red Bull-157	2015-2212				SEC29-T05S-R25E
AMC 431330	Red Bull-158	2015-2213				SEC29-T05S-R25E
AMC 431331	Red Bull-159	2015-2214				SEC29-T05S-R25E

Date: 7/25/2016

Page 47

RECEIVED  
BLM AZ STATE OFFICE  
2016 AUG - 3 A 9 23  
PHOENIX, ARIZONA

## EXHIBIT A

County: Graham

State: AZ

<u>BLM Serial #</u>	<u>Claim Name</u>	<u>Original Recording</u>		<u>Amended Recording</u>		<u>Location</u>
		<u>Recording #</u>	<u>Page #</u>	<u>Recording #</u>	<u>Page #</u>	
AMC 431332	Red Bull-160	2015-2215				SEC29-T05S-R25E
AMC 431333	Red Bull-161	2015-2216				SEC29-T05S-R25E
AMC 431334	Red Bull-162	2015-2217				SEC29-T05S-R25E
AMC 431335	Red Bull-163	2015-2218				SEC29-T05S-R25E
AMC 431336	Red Bull-164	2015-2219				SEC29-T05S-R25E
AMC 431337	Red Bull-165	2015-2220				SEC29-T05S-R25E
AMC 431338	Red Bull-166	2015-2221				SEC29-T05S-R25E
AMC 431339	Red Bull-167	2015-2222				SEC29-T05S-R25E
AMC 431340	Red Bull-168	2015-2223				SEC29-T05S-R25E
AMC 431341	Red Bull-169	2015-2224				SEC29-T05S-R25E
AMC 431342	Red Bull-170	2015-2225				SEC29-T05S-R25E
AMC 431343	Red Bull-171	2015-2226				SEC29-T05S-R25E
AMC 431344	Red Bull-172	2015-2227				SEC29-T05S-R25E
AMC 431345	Red Bull-173	2015-2228				SEC29-T05S-R25E
AMC 431346	Red Bull-174	2015-2229				SEC29-T05S-R25E
AMC 431347	Red Bull-175	2015-2230				SEC29-T05S-R25E
AMC 431348	Red Bull-176	2015-2231				SEC29-T05S-R25E
AMC 431349	Red Bull-177	2015-2232				SEC29-T05S-R25E
AMC 431350	Red Bull-178	2015-2233				SEC29-T05S-R25E
AMC 431351	Red Bull-179	2015-2234				SEC29-T05S-R25E
AMC 431352	Red Bull-180	2015-2235				SEC29-T05S-R25E
AMC 431353	Red Bull-181	2015-2236				SEC30-T05S-R25E
AMC 431354	Red Bull-182	2015-2237				SEC30-T05S-R25E
AMC 431355	Red Bull-183	2015-2238				SEC30-T05S-R25E
AMC 431356	Red Bull-184	2015-2239				SEC30-T05S-R25E
AMC 431357	Red Bull-185	2015-2240				SEC30-T05S-R25E
AMC 431358	Red Bull-186	2015-2241				SEC30-T05S-R25E
AMC 431359	Red Bull-187	2015-2242				SEC30-T05S-R25E
AMC 431360	Red Bull-188	2015-2243				SEC30-T05S-R25E
AMC 431361	Red Bull-189	2015-2244				SEC30-T05S-R25E
AMC 431362	Red Bull-190	2015-2245				SEC30-T05S-R25E
AMC 431363	Red Bull-191	2015-2246				SEC30-T05S-R25E
AMC 431364	Red Bull-192	2015-2247				SEC30-T05S-R25E
AMC 431365	Red Bull-193	2015-2248				SEC30-T05S-R25E
AMC 431366	Red Bull-194	2015-2249				SEC30-T05S-R25E
AMC 431367	Red Bull-195	2015-2250				SEC30-T05S-R25E
AMC 431368	Red Bull-196	2015-2251				SEC30-T05S-R25E
AMC 431369	Red Bull-197	2015-2252				SEC30-T05S-R25E

Date: 7/25/2016

RECEIVED  
BLM AZ STATE OFFICE

PHOENIX, ARIZONA  
 2016 AUG - 3  
 9:23

## EXHIBIT A

County: Graham

State: AZ

<u>BLM Serial #</u>	<u>Claim Name</u>	<u>Original Recording</u>		<u>Amended Recording</u>		<u>Location</u>
		<u>Recording #</u>	<u>Page #</u>	<u>Recording #</u>	<u>Page #</u>	
AMC 431370	Red Bull-198	2015-2253				SEC30-T05S-R25E
AMC 431371	Red Bull-199	2015-2254				SEC30-T05S-R25E
AMC 431372	Red Bull-200	2015-2255				SEC30-T05S-R25E
AMC 431373	Red Bull-201	2015-2256				SEC30-T05S-R25E
AMC 431374	Red Bull-202	2015-2257				SEC30-T05S-R25E
AMC 431375	Red Bull-203	2015-2258				SEC30-T05S-R25E
AMC 431376	Red Bull-204	2015-2259				SEC30-T05S-R25E
AMC 431377	Red Bull-205	2015-2260				SEC30-T05S-R25E
AMC 431378	Red Bull-206	2015-2261				SEC30-T05S-R25E
AMC 431379	Red Bull-207	2015-2262				SEC30-T05S-R25E
AMC 431380	Red Bull-208	2015-2263				SEC30-T05S-R25E
AMC 431381	Red Bull-209	2015-2264				SEC30-T05S-R25E
AMC 431382	Red Bull-210	2015-2265				SEC30-T05S-R25E
AMC 431383	Red Bull-211	2015-2266				SEC30-T05S-R25E
AMC 431384	Red Bull-212	2015-2267				SEC30-T05S-R25E
AMC 431385	Red Bull-213	2015-2268				SEC30-T05S-R25E
AMC 431386	Red Bull-214	2015-2269				SEC30-T05S-R25E
AMC 431387	Red Bull-215	2015-2270				SEC30-T05S-R25E
AMC 431388	Red Bull-216	2015-2271				SEC30-T05S-R25E
AMC 431389	Red Bull-217	2015-2272				SEC19-T05S-R25E
AMC 431390	Red Bull-218	2015-2273				SEC19-T05S-R25E
AMC 431391	Red Bull-219	2015-2274				SEC19-T05S-R25E
AMC 431392	Red Bull-220	2015-2275				SEC19-T05S-R25E
AMC 431393	Red Bull-221	2015-2276				SEC19-T05S-R25E
AMC 431394	Red Bull-222	2015-2277				SEC19-T05S-R25E
AMC 431395	Red Bull-223	2015-2278				SEC19-T05S-R25E
AMC 431396	Red Bull-224	2015-2279				SEC19-T05S-R25E
AMC 431397	Red Bull-225	2015-2280				SEC19-T05S-R25E
AMC 431398	Red Bull-226	2015-2281				SEC19-T05S-R25E
AMC 431399	Red Bull-227	2015-2282				SEC19-T05S-R25E
AMC 431400	Red Bull-228	2015-2283				SEC19-T05S-R25E
AMC 431401	Red Bull-229	2015-2284				SEC19-T05S-R25E
AMC 431402	Red Bull-230	2015-2285				SEC19-T05S-R25E
AMC 431403	Red Bull-231	2015-2286				SEC19-T05S-R25E
AMC 431404	Red Bull-232	2015-2287				SEC19-T05S-R25E
AMC 431405	Red Bull-233	2015-2288				SEC19-T05S-R25E
AMC 431406	Red Bull-234	2015-2289				SEC19-T05S-R25E
AMC 431407	Red Bull-235	2015-2290				SEC19-T05S-R25E

Date: 7/25/2016

RECEIVED  
BLM AZ STATE OFFICE  
2016 AUG - 3 A 9 20

## EXHIBIT A

County: Graham

State: AZ

BLM Serial #	Claim Name	Original Recording		Amended Recording		Location
		Recording #	Page #	Recording #	Page #	
AMC 431408	Red Bull-236	2015-2291				SEC19-T05S-R25E
AMC 431409	Red Bull-237	2015-2292				SEC19-T05S-R25E
AMC 431410	Red Bull-238	2015-2293				SEC19-T05S-R25E
AMC 431411	Red Bull-239	2015-2294				SEC19-T05S-R25E
AMC 431412	Red Bull-240	2015-2295				SEC19-T05S-R25E
AMC 431413	Red Bull-241	2015-2296				SEC19-T05S-R25E
AMC 431414	Red Bull-242	2015-2297				SEC19-T05S-R25E
AMC 431415	Red Bull-243	2015-2298				SEC19-T05S-R25E
AMC 431416	Red Bull-244	2015-2299				SEC20-T05S-R25E
AMC 431417	Red Bull-245	2015-2300				SEC20-T05S-R25E
AMC 431418	Red Bull-246	2015-2301				SEC20-T05S-R25E
AMC 431419	Red Bull-247	2015-2302				SEC20-T05S-R25E
AMC 431420	Red Bull-248	2015-2303				SEC20-T05S-R25E
AMC 431421	Red Bull-249	2015-2304				SEC20-T05S-R25E
AMC 431422	Red Bull-250	2015-2305				SEC20-T05S-R25E
AMC 431423	Red Bull-251	2015-2306				SEC20-T05S-R25E
AMC 431424	Red Bull-252	2015-2307				SEC20-T05S-R25E
AMC 431425	Red Bull-253	2015-2308				SEC20-T05S-R25E
AMC 431426	Red Bull-254	2015-2309				SEC20-T05S-R25E
AMC 431427	Red Bull-255	2015-2310				SEC20-T05S-R25E
AMC 431428	Red Bull-256	2015-2311				SEC20-T05S-R25E
AMC 431429	Red Bull-257	2015-2312				SEC20-T05S-R25E
AMC 431430	Red Bull-258	2015-2313				SEC20-T05S-R25E
AMC 431431	Red Bull-259	2015-2314				SEC20-T05S-R25E
AMC 431432	Red Bull-260	2015-2315				SEC20-T05S-R25E
AMC 431433	Red Bull-261	2015-2316				SEC20-T05S-R25E
AMC 431434	Red Bull-262	2015-2317				SEC20-T05S-R25E
AMC 431435	Red Bull-263	2015-2318				SEC20-T05S-R25E
AMC 431436	Red Bull-264	2015-2319				SEC20-T05S-R25E
AMC 431437	Red Bull-265	2015-2320				SEC20-T05S-R25E
AMC 431438	Red Bull-266	2015-2321				SEC20-T05S-R25E
AMC 431439	Red Bull-267	2015-2322				SEC20-T05S-R25E
AMC 431440	Red Bull-268	2015-2323				SEC20-T05S-R25E
AMC 431441	Red Bull-269	2015-2324				SEC20-T05S-R25E
AMC 431442	Red Bull-270	2015-2325				SEC20-T05S-R25E
AMC 431443	Red Bull-271	2015-2326				SEC20-T05S-R25E
AMC 431444	Red Bull-272	2015-2327				SEC20-T05S-R25E
AMC 431445	Red Bull-273	2015-2328				SEC20-T05S-R25E

Date: 7/25/2016

RECEIVED  
BLM AZ STATE OFFICE  
PHOENIX, ARIZONA  
AUG - 3 2016

## EXHIBIT A

County: Graham

State: AZ

<u>BLM Serial #</u>	<u>Claim Name</u>	<u>Original Recording</u>		<u>Amended Recording</u>		<u>Location</u>
		<u>Recording #</u>	<u>Page #</u>	<u>Recording #</u>	<u>Page #</u>	
AMC 431446	Red Bull-274	2015-2329				SEC20-T05S-R25E
AMC 431447	Red Bull-275	2015-2330				SEC20-T05S-R25E
AMC 431448	Red Bull-276	2015-2331				SEC20-T05S-R25E
AMC 431449	Red Bull-277	2015-2332				SEC20-T05S-R25E
AMC 431450	Red Bull-278	2015-2333				SEC20-T05S-R25E
AMC 431451	Red Bull-279	2015-2334				SEC20-T05S-R25E
AMC 431452	Red Bull-280	2015-2335				SEC21-T05S-R25E
AMC 431453	Red Bull-281	2015-2336				SEC21-T05S-R25E
AMC 431454	Red Bull-282	2015-2337				SEC21-T05S-R25E
AMC 431455	Red Bull-283	2015-2338				SEC21-T05S-R25E
AMC 431456	Red Bull-284	2015-2339				SEC21-T05S-R25E
AMC 431457	Red Bull-285	2015-2340				SEC21-T05S-R25E
AMC 431458	Red Bull-286	2015-2341				SEC21-T05S-R25E
AMC 431459	Red Bull-287	2015-2342				SEC21-T05S-R25E
AMC 431460	Red Bull-288	2015-2343				SEC21-T05S-R25E
AMC 431461	Red Bull-289	2015-2344				SEC21-T05S-R25E
AMC 431462	Red Bull-290	2015-2345				SEC21-T05S-R25E
AMC 431463	Red Bull-291	2015-2346				SEC21-T05S-R25E
AMC 431464	Red Bull-292	2015-2347				SEC21-T05S-R25E
AMC 431465	Red Bull-293	2015-2348				SEC21-T05S-R25E
AMC 431466	Red Bull-294	2015-2349				SEC21-T05S-R25E
AMC 431467	Red Bull-295	2015-2350				SEC21-T05S-R25E
AMC 431468	Red Bull-296	2015-2351				SEC21-T05S-R25E
AMC 431469	Red Bull-297	2015-2352				SEC21-T05S-R25E
AMC 431470	Red Bull-298	2015-2353				SEC21-T05S-R25E
AMC 431471	Red Bull-299	2015-2354				SEC21-T05S-R25E
AMC 431472	Red Bull-300	2015-2355				SEC21-T05S-R25E
AMC 431473	Red Bull-301	2015-2356				SEC21-T05S-R25E
AMC 431474	Red Bull-302	2015-2357				SEC21-T05S-R25E
AMC 431475	Red Bull-303	2015-2358				SEC21-T05S-R25E
AMC 431476	Red Bull-304	2015-2359				SEC21-T05S-R25E
AMC 431477	Red Bull-305	2015-2360				SEC21-T05S-R25E
AMC 431478	Red Bull-306	2015-2361				SEC21-T05S-R25E
AMC 431479	Red Bull-307	2015-2362				SEC21-T05S-R25E
AMC 431480	Red Bull-308	2015-2363				SEC21-T05S-R25E
AMC 431481	Red Bull-309	2015-2364				SEC21-T05S-R25E
AMC 431482	Red Bull-310	2015-2365				SEC21-T05S-R25E
AMC 431483	Red Bull-311	2015-2366				SEC21-T05S-R25E

Date: 7/25/2016

Page 51

RECEIVED  
BLM AZ STATE OFFICE  
2016 AUG - 3 A 9 23  
PHOENIX, ARIZONA



## EXHIBIT A

County: Graham

State: AZ

<u>BLM Serial #</u>	<u>Claim Name</u>	<u>Original Recording</u>		<u>Amended Recording</u>		<u>Location</u>
		<u>Recording #</u>	<u>Page #</u>	<u>Recording #</u>	<u>Page #</u>	
AMC 431484	Red Bull-312	2015-2367				SEC21-T05S-R25E
AMC 431485	Red Bull-313	2015-2368				SEC21-T05S-R25E
AMC 431486	Red Bull-314	2015-2369				SEC21-T05S-R25E
AMC 431487	Red Bull-315	2015-2370				SEC21-T05S-R25E
AMC 431488	Red Bull-379	2015-2130				SEC14-T05S-R25E
AMC 431489	Red Bull-380	2015-2131				SEC14-T05S-R25E
AMC 431490	Red Bull-381	2015-2132				SEC14-T05S-R25E
AMC 431491	Red Bull-382	2015-2133				SEC14-T05S-R25E
AMC 431492	Red Bull-383	2015-2134				SEC14-T05S-R25E
AMC 431493	Red Bull-384	2015-2135				SEC14-T05S-R25E
AMC 431494	Red Bull-385	2015-2136				SEC14-T05S-R25E
AMC 431495	Red Bull-386	2015-2137				SEC14-T05S-R25E
AMC 431496	Red Bull-387	2015-2138				SEC14-T05S-R25E
AMC 431497	Red Bull-388	2015-2139				SEC14-T05S-R25E
AMC 431498	Red Bull-389	2015-2140				SEC14-T05S-R25E
AMC 431499	Red Bull-390	2015-2141				SEC14-T05S-R25E
AMC 431500	Red Bull-391	2015-2142				SEC14-T05S-R25E
AMC 431501	Red Bull-392	2015-2143				SEC14-T05S-R25E
AMC 431502	Red Bull-393	2015-2144				SEC14-T05S-R25E
AMC 431503	Red Bull-394	2015-2145				SEC14-T05S-R25E
AMC 431504	Red Bull-395	2015-2146				SEC14-T05S-R25E
AMC 431505	Red Bull-396	2015-2147				SEC14-T05S-R25E
AMC 431506	Red Bull-397	2015-2148				SEC13-T05S-R25E
AMC 431507	Red Bull-398	2015-2149				SEC13-T05S-R25E
AMC 431508	Red Bull-399	2015-2150				SEC13-T05S-R25E
AMC 431509	Red Bull-400	2015-2151				SEC13-T05S-R25E
AMC 431510	Red Bull-401	2015-2152				SEC13-T05S-R25E
AMC 431511	Red Bull-402	2015-2153				SEC13-T05S-R25E
AMC 431512	Red Bull-403	2015-2154				SEC13-T05S-R25E
AMC 431513	Red Bull-404	2015-2155				SEC13-T05S-R25E
AMC 431514	Red Bull-405	2015-2156				SEC13-T05S-R25E
AMC 431515	Red Bull-406	2015-2157				SEC13-T05S-R25E
AMC 431516	Red Bull-407	2015-2158				SEC13-T05S-R25E
AMC 431517	Red Bull-408	2015-2159				SEC13-T05S-R25E
AMC 431518	Red Bull-409	2015-2160				SEC13-T05S-R25E
AMC 431519	Red Bull-410	2015-2161				SEC13-T05S-R25E
AMC 431520	Red Bull-411	2015-2162				SEC13-T05S-R25E
AMC 431521	Red Bull-412	2015-2163				SEC13-T05S-R25E

Date: 7/25/2016

Page 52

RECEIVED  
BLM AZ STATE OFFICE

2016 AUG - 3 A 9 23

PHOENIX, ARIZONA

## EXHIBIT A

County: Graham

State: AZ

<u>BLM Serial #</u>	<u>Claim Name</u>	<u>Original Recording</u>		<u>Amended Recording</u>		<u>Location</u>
		<u>Recording #</u>	<u>Page #</u>	<u>Recording #</u>	<u>Page #</u>	
AMC 431522	Red Bull-413	2015-2164				SEC13-T05S-R25E
AMC 431523	Red Bull-414	2015-2165				SEC13-T05S-R25E
AMC 431524	Red Bull-415	2015-2166				SEC13-T05S-R25E
AMC 431525	Red Bull-416	2015-2167				SEC13-T05S-R25E
AMC 431526	Red Bull-417	2015-2168				SEC13-T05S-R25E
AMC 431527	Red Bull-418	2015-2169				SEC13-T05S-R25E
AMC 431528	Red Bull-419	2015-2170				SEC13-T05S-R25E
AMC 431529	Red Bull-420	2015-2171				SEC13-T05S-R25E
AMC 431530	Red Bull-421	2015-2172				SEC13-T05S-R25E
AMC 431531	Red Bull 422	2015-2173				SEC13-T05S-R25E
AMC 431532	Red Bull-423	2015-2174				SEC13-T05S-R25E
AMC 431533	Red Bull-424	2015-2175				SEC13-T05S-R25E
AMC 431534	Red Bull-425	2015-2176				SEC13-T05S-R25E
AMC 431535	Red Bull-426	2015-2177				SEC13-T05S-R25E
AMC 431536	Red Bull-427	2015-2178				SEC13-T05S-R25E
AMC 431537	Red Bull-428	2015-2179				SEC13-T05S-R25E
AMC 431538	Red Bull-429	2015-2180				SEC13-T05S-R25E
AMC 431539	Red Bull-430	2015-2181				SEC13-T05S-R25E
AMC 431540	Red Bull-431	2015-2182				SEC13-T05S-R25E
AMC 431541	Red Bull-432	2015-2183				SEC13-T05S-R25E
AMC 431542	Red Bull-469	2015-2184				SEC23-T05S-R25E
AMC 431543	Red Bull-470	2015-2185				SEC23-T05S-R25E
AMC 431544	Red Bull-471	2015-2186				SEC23-T05S-R25E
AMC 431545	Red Bull-472	2015-2187				SEC23-T05S-R25E
AMC 431546	Red Bull-473	2015-2188				SEC23-T05S-R25E
AMC 431547	Red Bull-474	2015-2189				SEC23-T05S-R25E
AMC 431548	Red Bull-475	2015-2190				SEC23-T05S-R25E
AMC 431549	Red Bull-476	2015-2191				SEC23-T05S-R25E
AMC 431550	Red Bull-477	2015-2192				SEC23-T05S-R25E
AMC 431551	Red Bull-478	2015-2193				SEC23-T05S-R25E
AMC 431552	Red Bull-479	2015-2194				SEC23-T05S-R25E
AMC 431553	Red Bull-480	2015-2195				SEC23-T05S-R25E
AMC 431554	Red Bull-481	2015-2196				SEC23-T05S-R25E
AMC 431555	Red Bull-482	2015-2197				SEC23-T05S-R25E
AMC 431556	Red Bull-483	2015-2198				SEC23-T05S-R25E
AMC 431557	Red Bull-484	2015-2199				SEC23-T05S-R25E
AMC 431566	ROCKSTAR 173	2015-2450				SEC36-T06S-R27E
AMC 431567	ROCKSTAR 174	2015-2451				SEC36-T06S-R27E

Date: 7/25/2016

RECEIVED  
BLM AZ STATE OFFICE

PHOENIX, ARIZONA  
2016 AUG - 3 A 9 23

## EXHIBIT A

County: Graham

State: AZ

BLM Serial #	Claim Name	Original Recording		Amended Recording		Location
		Recording #	Page #	Recording #	Page #	
AMC 431568	ROCKSTAR 175	2015-2452				SEC36-T06S-R27E
AMC 431569	ROCKSTAR 176	2015-2453				SEC36-T06S-R27E
AMC 431570	ROCKSTAR 177	2015-2454				SEC36-T06S-R27E
AMC 431571	ROCKSTAR 178	2015-2455				SEC36-T06S-R27E
AMC 431572	ROCKSTAR 179	2015-2456				SEC35-T06S-R27E
AMC 431573	ROCKSTAR 180	2015-2457				SEC35-T06S-R27E
AMC 431574	ROCKSTAR 181	2015-2458				SEC35-T06S-R27E
AMC 431575	ROCKSTAR 182	2015-2459				SEC35-T06S-R27E
AMC 431576	ROCKSTAR 183	2015-2460				SEC35-T06S-R27E
AMC 431577	ROCKSTAR 184	2015-2461				SEC35-T06S-R27E
AMC 431578	ROCKSTAR 185	2015-2462				SEC35-T06S-R27E
AMC 431579	ROCKSTAR 186	2015-2463				SEC35-T06S-R27E
AMC 431580	ROCKSTAR 187	2015-2464				SEC35-T06S-R27E
AMC 431581	ROCKSTAR 188	2015-2465				SEC35-T06S-R27E
AMC 431582	ROCKSTAR 189	2015-2466				SEC35-T06S-R27E
AMC 431583	ROCKSTAR 190	2015-2467				SEC35-T06S-R27E
AMC 431584	ROCKSTAR 191	2015-2468				SEC35-T06S-R27E
AMC 431585	ROCKSTAR 192	2015-2469				SEC35-T06S-R27E
AMC 431586	ROCKSTAR 193	2015-2470				SEC35-T06S-R27E
AMC 431587	ROCKSTAR 194	2015-2471				SEC35-T06S-R27E
AMC 431588	ROCKSTAR 195	2015-2472				SEC35-T06S-R27E
AMC 431589	ROCKSTAR 196	2015-2473				SEC35-T06S-R27E
AMC 431590	ROCKSTAR 197	2015-2474				SEC34-T06S-R27E
AMC 431591	ROCKSTAR 198	2015-2475				SEC34-T06S-R27E
AMC 431592	ROCKSTAR 199	2015-2476				SEC34-T06S-R27E
AMC 431593	ROCKSTAR 200	2015-2477				SEC34-T06S-R27E
AMC 431594	ROCKSTAR 201	2015-2478				SEC34-T06S-R27E
AMC 431595	ROCKSTAR 202	2015-2479				SEC34-T06S-R27E
AMC 431596	ROCKSTAR 203	2015-2480				SEC34-T06S-R27E
AMC 431597	ROCKSTAR 204	2015-2481				SEC34-T06S-R27E
AMC 431598	ROCKSTAR 205	2015-2482				SEC34-T06S-R27E
AMC 431599	ROCKSTAR 206	2015-2483				SEC34-T06S-R27E
AMC 431600	ROCKSTAR 207	2015-2484				SEC34-T06S-R27E
AMC 431601	ROCKSTAR 208	2015-2485				SEC34-T06S-R27E
AMC 431602	ROCKSTAR 209	2015-2486				SEC35-T06S-R27E
AMC 431603	ROCKSTAR 210	2015-2487				SEC27-T06S-R27E
AMC 431611	ROCKSTAR 211	2015-2591				SEC04-T07S-R27E
AMC 431612	ROCKSTAR 212	2015-2592				SEC04-T07S-R27E

Date: 7/25/2016

Page 54

RECEIVED  
 BLM AZ STATE OFFICE  
 PHOENIX, ARIZONA  
 2016 AUG - 3 A 9 21

## EXHIBIT A

County: Graham

State: AZ

<u>BLM Serial #</u>	<u>Claim Name</u>	<u>Original Recording</u>		<u>Amended Recording</u>		<u>Location</u>
		<u>Recording #</u>	<u>Page #</u>	<u>Recording #</u>	<u>Page #</u>	
AMC 431613	ROCKSTAR 213	2015-2593				SEC04-T07S-R27E
AMC 431614	ROCKSTAR 214	2015-2594				SEC04-T07S-R27E
AMC 431615	ROCKSTAR 215	2015-2595				SEC04-T07S-R27E
AMC 431616	ROCKSTAR 216	2015-2596				SEC04-T07S-R27E
AMC 431617	ROCKSTAR 217	2015-2597				SEC04-T07S-R27E
AMC 431618	ROCKSTAR 218	2015-2598				SEC04-T07S-R27E
AMC 431619	ROCKSTAR 219	2015-2599				SEC04-T07S-R27E
AMC 431620	ROCKSTAR 220	2015-2600				SEC04-T07S-R27E
AMC 431621	ROCKSTAR 221	2015-2601				SEC04-T07S-R27E
AMC 431622	ROCKSTAR 222	2015-2602				SEC04-T07S-R27E
AMC 431623	ROCKSTAR 223	2015-2603				SEC04-T07S-R27E
AMC 431624	ROCKSTAR 224	2015-2604				SEC04-T07S-R27E
AMC 431625	ROCKSTAR 225	2015-2605				SEC04-T07S-R27E
AMC 431626	ROCKSTAR 226	2015-2606				SEC04-T07S-R27E
AMC 431627	ROCKSTAR 227	2015-2607				SEC04-T07S-R27E
AMC 431628	ROCKSTAR 228	2015-2608				SEC04-T07S-R27E
AMC 431629	ROCKSTAR 229	2015-2609				SEC04-T07S-R27E
AMC 431630	ROCKSTAR 230	2015-2610				SEC04-T07S-R27E
AMC 431631	ROCKSTAR 231	2015-2611				SEC04-T07S-R27E
AMC 431632	ROCKSTAR 232	2015-2612				SEC04-T07S-R27E
AMC 431633	ROCKSTAR 233	2015-2613				SEC04-T07S-R27E
AMC 431634	ROCKSTAR 234	2015-2614				SEC04-T07S-R27E
AMC 431635	ROCKSTAR 235	2015-2615				SEC04-T07S-R27E
AMC 431636	ROCKSTAR 236	2015-2616				SEC04-T07S-R27E
AMC 431637	ROCKSTAR 237	2015-2617				SEC04-T07S-R27E
AMC 431638	ROCKSTAR 238	2015-2618				SEC04-T07S-R27E
AMC 431639	ROCKSTAR 239	2015-2619				SEC04-T07S-R27E
AMC 431640	ROCKSTAR 240	2015-2620				SEC04-T07S-R27E
AMC 431641	ROCKSTAR 241	2015-2621				SEC04-T07S-R27E
AMC 431642	ROCKSTAR 242	2015-2622				SEC04-T07S-R27E
AMC 431643	ROCKSTAR 243	2015-2623				SEC08-T07S-R27E
AMC 431644	ROCKSTAR 244	2015-2624				SEC08-T07S-R27E
AMC 431645	ROCKSTAR 245	2015-2625				SEC08-T07S-R27E
AMC 431646	ROCKSTAR 246	2015-2626				SEC08-T07S-R27E
AMC 431647	ROCKSTAR 247	2015-2627				SEC08-T07S-R27E
AMC 431648	ROCKSTAR 248	2015-2628				SEC08-T07S-R27E
AMC 431649	ROCKSTAR 249	2015-2629				SEC08-T07S-R27E
AMC 431650	ROCKSTAR 250	2015-2630				SEC08-T07S-R27E

Date: 7/25/2016

RECEIVED  
 BLM AZ STATE OFFICE  
 2016 AUG - 3 A 9:24  
 PHOENIX, ARIZONA

## EXHIBIT A

County: Graham

State: AZ

BLM Serial #	Claim Name	Original Recording		Amended Recording		Location
		Recording #	Page #	Recording #	Page #	
AMC 431651	ROCKSTAR 251	2015-2631				SEC08-T07S-R27E
AMC 431652	ROCKSTAR 252	2015-2632				SEC08-T07S-R27E
AMC 431653	ROCKSTAR 253	2015-2633				SEC08-T07S-R27E
AMC 431654	ROCKSTAR 254	2015-2634				SEC08-T07S-R27E
AMC 431655	ROCKSTAR 255	2015-2635				SEC08-T07S-R27E
AMC 431656	ROCKSTAR 256	2015-2636				SEC08-T07S-R27E
AMC 431657	ROCKSTAR 257	2015-2637				SEC08-T07S-R27E
AMC 431658	ROCKSTAR 258	2015-2638				SEC08-T07S-R27E
AMC 431659	ROCKSTAR 259	2015-2639				SEC08-T07S-R27E
AMC 431660	ROCKSTAR 260	2015-2640				SEC08-T07S-R27E
AMC 431661	ROCKSTAR 261	2015-2641				SEC08-T07S-R27E
AMC 431662	ROCKSTAR 262	2015-2642				SEC08-T07S-R27E
AMC 431663	ROCKSTAR 263	2015-2643				SEC08-T07S-R27E
AMC 431664	ROCKSTAR 264	2015-2644				SEC08-T07S-R27E
AMC 431665	ROCKSTAR 265	2015-2645				SEC07-T07S-R27E
AMC 431666	ROCKSTAR 266	2015-2646				SEC07-T07S-R27E
AMC 431667	ROCKSTAR 267	2015-2647				SEC07-T07S-R27E
AMC 431668	ROCKSTAR 268	2015-2648				SEC07-T07S-R27E
AMC 431669	ROCKSTAR 269	2015-2649				SEC07-T07S-R27E
AMC 431671	ROCKSTAR 271	2015-2651				SEC07-T07S-R27E
AMC 431672	ROCKSTAR 272	2015-2652				SEC07-T07S-R27E
AMC 431673	ROCKSTAR 273	2015-2653				SEC07-T07S-R27E
AMC 431674	ROCKSTAR 274	2015-2654				SEC07-T07S-R27E
AMC 431675	ROCKSTAR 275	2015-2655				SEC07-T07S-R27E
AMC 431676	ROCKSTAR 276	2015-2656				SEC07-T07S-R27E
AMC 431677	ROCKSTAR 277	2015-2657				SEC07-T07S-R27E
AMC 431678	ROCKSTAR 278	2015-2658				SEC07-T07S-R27E
AMC 431679	ROCKSTAR 279	2015-2659				SEC07-T07S-R27E
AMC 431683	ROCKSTAR 283	2015-2663				SEC07-T07S-R27E
AMC 431791	MONSTER-224	2015-2808				SEC22-T05S-R27E
AMC 431792	MONSTER-225	2015-2809				SEC22-T05S-R27E
AMC 431793	MONSTER-226	2015-2810				SEC22-T05S-R27E
AMC 431794	MONSTER-227	2015-2811				SEC22-T05S-R27E
AMC 431795	MONSTER-228	2015-2812				SEC22-T05S-R27E
AMC 431796	MONSTER-229	2015-2813				SEC22-T05S-R27E
AMC 431797	MONSTER-230	2015-2814				SEC22-T05S-R27E
AMC 431798	MONSTER-231	2015-2815				SEC22-T05S-R27E
AMC 431799	MONSTER-232	2015-2816				SEC22-T05S-R27E

Date: 7/25/2016

Page 56

RECEIVED  
BLM AZ STATE OFFICE  
2016 AUG - 3 A 9 21  
PHOENIX, ARIZONA

## EXHIBIT A

County: Graham

State: AZ

<u>BLM Serial #</u>	<u>Claim Name</u>	<u>Original Recording</u>		<u>Amended Recording</u>		<u>Location</u>
		<u>Recording #</u>	<u>Page #</u>	<u>Recording #</u>	<u>Page #</u>	
AMC 431800	MONSTER-233	2015-2817				SEC22-T05S-R27E
AMC 431801	MONSTER-234	2015-2818				SEC22-T05S-R27E
AMC 431802	MONSTER-235	2015-2819				SEC22-T05S-R27E
AMC 431803	MONSTER-236	2015-2820				SEC22-T05S-R27E
AMC 431804	MONSTER-237	2015-2821				SEC22-T05S-R27E
AMC 431805	MONSTER-238	2015-2822				SEC22-T05S-R27E
AMC 431806	MONSTER-239	2015-2823				SEC22-T05S-R27E
AMC 431807	MONSTER-240	2015-2824				SEC22-T05S-R27E
AMC 431808	MONSTER-241	2015-2825				SEC22-T05S-R27E
AMC 431809	MONSTER-242	2015-2826				SEC22-T05S-R27E
AMC 431810	MONSTER-243	2015-2827				SEC22-T05S-R27E
AMC 431811	MONSTER-244	2015-2828				SEC22-T05S-R27E
AMC 431812	MONSTER-245	2015-2829				SEC22-T05S-R27E
AMC 431813	MONSTER-246	2015-2830				SEC22-T05S-R27E
AMC 431814	MONSTER-247	2015-2831				SEC22-T05S-R27E
AMC 431815	MONSTER-248	2015-2832				SEC22-T05S-R27E
AMC 431816	MONSTER-249	2015-2833				SEC22-T05S-R27E
AMC 431817	MONSTER-250	2015-2834				SEC22-T05S-R27E
AMC 431818	MONSTER-251	2015-2835				SEC22-T05S-R27E
AMC 431819	MONSTER-252	2015-2836				SEC22-T05S-R27E
AMC 431820	MONSTER-253	2015-2837				SEC22-T05S-R27E
AMC 431821	MONSTER-254	2015-2838				SEC22-T05S-R27E
AMC 431822	MONSTER-255	2015-2839				SEC22-T05S-R27E
AMC 431823	MONSTER-256	2015-2840				SEC22-T05S-R27E
AMC 431824	MONSTER-257	2015-2841				SEC22-T05S-R27E
AMC 431825	MONSTER-258	2015-2842				SEC22-T05S-R27E
AMC 431826	MONSTER-259	2015-2843				SEC21-T05S-R27E
AMC 431827	MONSTER-260	2015-2844				SEC21-T05S-R27E
AMC 431828	MONSTER-261	2015-2845				SEC21-T05S-R27E
AMC 431829	MONSTER-262	2015-2846				SEC21-T05S-R27E
AMC 431830	MONSTER-263	2015-2847				SEC21-T05S-R27E
AMC 431831	MONSTER-264	2015-2848				SEC21-T05S-R27E
AMC 431832	MONSTER-265	2015-2849				SEC21-T05S-R27E
AMC 431833	MONSTER-266	2015-2850				SEC21-T05S-R27E
AMC 431834	MONSTER-267	2015-2851				SEC21-T05S-R27E
AMC 431835	MONSTER-268	2015-2852				SEC21-T05S-R27E
AMC 431836	MONSTER-269	2015-2853				SEC21-T05S-R27E
AMC 431837	MONSTER-270	2015-2854				SEC21-T05S-R27E

Date: 7/25/2016

RECEIVED  
BLM AZ STATE OFFICE  
2016 AUG - 3 A 9 24  
PHOENIX, ARIZONA

## EXHIBIT A

County: Graham

State: AZ

BLM Serial #	Claim Name	Original Recording		Amended Recording		Location
		Recording #	Page #	Recording #	Page #	
AMC 431838	MONSTER-271	2015-2855				SEC21-T05S-R27E
AMC 431839	MONSTER-272	2015-2856				SEC21-T05S-R27E
AMC 431840	MONSTER-277	2015-2857				SEC21-T05S-R27E
AMC 431841	MONSTER-278	2015-2858				SEC21-T05S-R27E
AMC 431842	MONSTER-279	2015-2859				SEC21-T05S-R27E
AMC 431843	MONSTER-280	2015-2860				SEC21-T05S-R27E
AMC 431844	MONSTER-285	2015-2861				SEC21-T05S-R27E
AMC 431845	MONSTER-286	2015-2862				SEC21-T05S-R27E
AMC 431846	MONSTER-287	2015-2863				SEC21-T05S-R27E
AMC 431847	MONSTER-288	2015-2864				SEC21-T05S-R27E
AMC 431848	MONSTER-293	2015-2865				SEC21-T05S-R27E
AMC 431849	MONSTER-294	2015-2866				SEC21-T05S-R27E
AMC 431850	MONSTER-421	2015-2867				SEC16-T05S-R27E
AMC 431851	MONSTER-422	2015-2868				SEC16-T05S-R27E
AMC 431852	MONSTER-423	2015-2869				SEC16-T05S-R27E
AMC 431853	MONSTER-424	2015-2870				SEC16-T05S-R27E
AMC 431854	MONSTER-425	2015-2871				SEC16-T05S-R27E
AMC 431855	MONSTER-426	2015-2872				SEC16-T05S-R27E
AMC 431856	MONSTER-427	2015-2873				SEC16-T05S-R27E
AMC 431857	MONSTER-428	2015-2874				SEC16-T05S-R27E
AMC 431858	MONSTER-429	2015-2875				SEC16-T05S-R27E
AMC 431859	MONSTER-430	2015-2876				SEC16-T05S-R27E
AMC 431860	MONSTER-431	2015-2877				SEC16-T05S-R27E
AMC 431861	MONSTER-432	2015-2878				SEC16-T05S-R27E
AMC 431862	MONSTER-433	2015-2879				SEC16-T05S-R27E
AMC 431863	MONSTER-434	2015-2880				SEC16-T05S-R27E
AMC 431864	MONSTER-435	2015-2881				SEC16-T05S-R27E
AMC 431865	MONSTER-436	2015-2882				SEC16-T05S-R27E
AMC 431866	MONSTER-437	2015-2883				SEC16-T05S-R27E
AMC 431867	MONSTER-438	2015-2884				SEC16-T05S-R27E
AMC 431868	MONSTER-439	2015-2885				SEC16-T05S-R27E
AMC 431869	MONSTER-440	2015-2886				SEC16-T05S-R27E
AMC 431870	MONSTER-441	2015-2887				SEC16-T05S-R27E
AMC 431871	MONSTER-442	2015-2888				SEC16-T05S-R27E
AMC 431872	MONSTER-443	2015-2889				SEC16-T05S-R27E
AMC 431873	MONSTER-444	2015-2890				SEC16-T05S-R27E
AMC 431874	MONSTER-445	2015-2891				SEC16-T05S-R27E
AMC 431875	MONSTER-446	2015-2892				SEC16-T05S-R27E

Date: 7/25/2016

Page 58

RECEIVED  
BLM AZ STATE OFFICE  
2016 AUG - 3 A 9 24  
PHOENIX, ARIZONA

## EXHIBIT A

County: Graham

State: AZ

<u>BLM Serial #</u>	<u>Claim Name</u>	<u>Original Recording</u>		<u>Amended Recording</u>		<u>Location</u>
		<u>Recording #</u>	<u>Page #</u>	<u>Recording #</u>	<u>Page #</u>	
AMC 431876	MONSTER-447	2015-2893				SEC16-T05S-R27E
AMC 431877	MONSTER-448	2015-2894				SEC16-T05S-R25E
AMC 431878	MONSTER-449	2015-2895				SEC15-T05S-R27E
AMC 431879	MONSTER-450	2015-2896				SEC15-T05S-R27E
AMC 431880	MONSTER-451	2015-2897				SEC15-T05S-R27E
AMC 431881	MONSTER-452	2015-2898				SEC15-T05S-R27E
AMC 431882	MONSTER-453	2015-2899				SEC15-T05S-R27E
AMC 431883	MONSTER-454	2015-2900				SEC15-T05S-R27E
AMC 431884	MONSTER-455	2015-2901				SEC15-T05S-R27E
AMC 431885	MONSTER-456	2015-2902				SEC15-T05S-R27E
AMC 431886	MONSTER-457	2015-2903				SEC15-T05S-R27E
AMC 431887	MONSTER-458	2015-2904				SEC15-T05S-R27E
AMC 431888	MONSTER-459	2015-2905				SEC15-T05S-R27E
AMC 431889	MONSTER-460	2015-2906				SEC15-T05S-R27E
AMC 431890	MONSTER-461	2015-2907				SEC15-T05S-R27E
AMC 431891	MONSTER-462	2015-2908				SEC15-T05S-R27E
AMC 431892	MONSTER-463	2015-2909				SEC15-T05S-R27E
AMC 431893	MONSTER-464	2015-2910				SEC15-T05S-R27E
AMC 431894	MONSTER-465	2015-2911				SEC15-T05S-R27E
AMC 431895	MONSTER-466	2015-2912				SEC15-T05S-R27E
AMC 431896	MONSTER-467	2015-2913				SEC15-T05S-R27E
AMC 431897	MONSTER-468	2015-2914				SEC15-T05S-R27E
AMC 431898	MONSTER-469	2015-2915				SEC15-T05S-R27E
AMC 431899	MONSTER-470	2015-2916				SEC15-T05S-R27E
AMC 431900	MONSTER-471	2015-2917				SEC15-T05S-R27E
AMC 431901	MONSTER-472	2015-2918				SEC15-T05S-R27E
AMC 431902	MONSTER-473	2015-2919				SEC15-T05S-R27E
AMC 431903	MONSTER-474	2015-2920				SEC15-T05S-R27E
AMC 431904	MONSTER-109	2015-2664				SEC27-T05S-R27E
AMC 431905	MONSTER-110	2015-2665				SEC27-T05S-R27E
AMC 431906	MONSTER-111	2015-2666				SEC27-T05S-R27E
AMC 431907	MONSTER-112	2015-2667				SEC27-T05S-R27E
AMC 431908	MONSTER-113	2015-2668				SEC27-T05S-R27E
AMC 431909	MONSTER-114	2015-2669				SEC27-T05S-R27E
AMC 431910	MONSTER-115	2015-2670				SEC27-T05S-R27E
AMC 431911	MONSTER-116	2015-2671				SEC27-T05S-R27E
AMC 431912	MONSTER-117	2015-2672				SEC27-T05S-R27E
AMC 431913	MONSTER-118	2015-2673				SEC27-T05S-R27E

Date: 7/25/2016

RECEIVED  
BLM AZ STATE OFFICE  
2016 AUG - 3 A 9 24  
PHOENIX, ARIZONA



## EXHIBIT A

County: Graham

State: AZ

<u>BLM Serial #</u>	<u>Claim Name</u>	<u>Original Recording</u>		<u>Amended Recording</u>		<u>Location</u>
		<u>Recording #</u>	<u>Page #</u>	<u>Recording #</u>	<u>Page #</u>	
AMC 431914	MONSTER-119	2015-2674				SEC27-T05S-R27E
AMC 431915	MONSTER-120	2015-2675				SEC27-T05S-R27E
AMC 431916	MONSTER-121	2015-2676				SEC27-T05S-R27E
AMC 431917	MONSTER-122	2015-2677				SEC27-T05S-R27E
AMC 431918	MONSTER-123	2015-2678				SEC27-T05S-R27E
AMC 431919	MONSTER-124	2015-2679				SEC27-T05S-R27E
AMC 431920	MONSTER-125	2015-2680				SEC27-T05S-R27E
AMC 431921	MONSTER-126	2015-2681				SEC27-T05S-R27E
AMC 431922	MONSTER-127	2015-2682				SEC27-T05S-R27E
AMC 431923	MONSTER-128	2015-2683				SEC27-T05S-R27E
AMC 431924	MONSTER-129	2015-2684				SEC27-T05S-R27E
AMC 431925	MONSTER-130	2015-2685				SEC27-T05S-R27E
AMC 431926	MONSTER-131	2015-2686				SEC27-T05S-R27E
AMC 431927	MONSTER-132	2015-2687				SEC27-T05S-R27E
AMC 431928	MONSTER-133	2015-2688				SEC27-T05S-R27E
AMC 431929	MONSTER-134	2015-2689				SEC27-T05S-R27E
AMC 431930	MONSTER-135	2015-2690				SEC27-T05S-R27E
AMC 431931	MONSTER-136	2015-2691				SEC27-T05S-R27E
AMC 431932	MONSTER-137	2015-2692				SEC27-T05S-R27E
AMC 431933	MONSTER-138	2015-2693				SEC27-T05S-R27E
AMC 431934	MONSTER-139	2015-2694				SEC27-T05S-R27E
AMC 431935	MONSTER-140	2015-2695				SEC27-T05S-R27E
AMC 431936	MONSTER-141	2015-2696				SEC34-T05S-R27E
AMC 431937	MONSTER-142	2015-2697				SEC34-T05S-R27E
AMC 431938	MONSTER-143	2015-2698				SEC34-T05S-R27E
AMC 431939	MONSTER-144	2015-2699				SEC34-T05S-R27E
AMC 431940	MONSTER-145	2015-2700				SEC34-T05S-R27E
AMC 431941	MONSTER-146	2015-2701				SEC34-T05S-R27E
AMC 431942	MONSTER-147	2015-2702				SEC34-T05S-R27E
AMC 431943	MONSTER-148	2015-2703				SEC34-T05S-R27E
AMC 431944	MONSTER-151	2015-2704				SEC34-T05S-R27E
AMC 431945	MONSTER-152	2015-2705				SEC34-T05S-R27E
AMC 431946	MONSTER-153	2015-2706				SEC34-T05S-R27E
AMC 431947	MONSTER-154	2015-2707				SEC34-T05S-R27E
AMC 431948	MONSTER-155	2015-2708				SEC34-T05S-R27E
AMC 431949	MONSTER-156	2015-2709				SEC34-T05S-R27E
AMC 431950	MONSTER-157	2015-2710				SEC34-T05S-R27E
AMC 431951	MONSTER-158	2015-2711				SEC34-T05S-R27E

Date: 7/25/2016

RECEIVED  
BLM AZ STATE OFFICE  
2016 AUG - 3 A 9 24

## EXHIBIT A

County: Graham

State: AZ

<u>BLM Serial #</u>	<u>Claim Name</u>	<u>Original Recording</u>		<u>Amended Recording</u>		<u>Location</u>
		<u>Recording #</u>	<u>Page #</u>	<u>Recording #</u>	<u>Page #</u>	
AMC 431952	MONSTER-177	2015-2712				SEC35-T05S-R27E
AMC 431953	MONSTER-178	2015-2713				SEC35-T05S-R27E
AMC 431954	MONSTER-179	2015-2714				SEC35-T05S-R27E
AMC 431955	MONSTER-180	2015-2715				SEC35-T05S-R27E
AMC 431956	MONSTER-181	2015-2716				SEC35-T05S-R27E
AMC 431957	MONSTER-182	2015-2717				SEC35-T05S-R27E
AMC 431958	MONSTER-183	2015-2718				SEC35-T05S-R27E
AMC 431959	MONSTER-184	2015-2719				SEC35-T05S-R27E
AMC 431960	MONSTER-185	2015-2720				SEC35-T05S-R27E
AMC 431961	MONSTER-186	2015-2721				SEC35-T05S-R27E
AMC 431962	MONSTER-187	2015-2722				SEC35-T05S-R27E
AMC 431963	MONSTER-188	2015-2723				SEC35-T05S-R27E
AMC 431964	MONSTER-189	2015-2724				SEC35-T05S-R27E
AMC 431965	MONSTER-190	2015-2725				SEC35-T05S-R27E
AMC 431966	MONSTER-191	2015-2726				SEC35-T05S-R27E
AMC 431967	MONSTER-192	2015-2727				SEC35-T05S-R27E
AMC 431968	MONSTER-193	2015-2728				SEC35-T05S-R27E
AMC 431969	MONSTER-194	2015-2729				SEC35-T05S-R27E
AMC 431970	MONSTER-195	2015-2730				SEC35-T05S-R27E
AMC 431971	MONSTER-196	2015-2731				SEC35-T05S-R27E
AMC 431972	MONSTER-197	2015-2732				SEC35-T05S-R27E
AMC 431973	MONSTER-198	2015-2733				SEC35-T05S-R27E
AMC 431974	MONSTER-199	2015-2734				SEC35-T05S-R27E
AMC 431975	MONSTER-200	2015-2735				SEC35-T05S-R27E
AMC 431976	MONSTER-201	2015-2736				SEC35-T05S-R27E
AMC 431977	MONSTER-202	2015-2737				SEC26-T05S-R27E
AMC 431978	MONSTER-203	2015-2738				SEC26-T05S-R27E
AMC 431979	MONSTER-204	2015-2739				SEC26-T05S-R27E
AMC 431980	MONSTER-205	2015-2740				SEC26-T05S-R27E
AMC 431981	MONSTER-206	2015-2741				SEC26-T05S-R27E
AMC 431982	MONSTER-207	2015-2742				SEC26-T05S-R27E
AMC 431983	MONSTER-208	2015-2743				SEC26-T05S-R27E
AMC 431984	MONSTER-209	2015-2744				SEC26-T05S-R27E
AMC 431985	MONSTER-210	2015-2745				SEC26-T05S-R27E
AMC 431986	MONSTER-211	2015-2746				SEC26-T05S-R27E
AMC 431987	MONSTER-212	2015-2747				SEC26-T05S-R27E
AMC 431988	MONSTER-213	2015-2748				SEC26-T05S-R27E
AMC 431989	MONSTER-214	2015-2749				SEC26-T05S-R27E

Date: 7/25/2016

RECEIVED  
BLM AZ STATE OFFICE  
2016 AUG - 3 A 9 24  
HOENIX, ARIZONA

## EXHIBIT A

County: Graham

State: AZ

<u>BLM Serial #</u>	<u>Claim Name</u>	<u>Original Recording</u>		<u>Amended Recording</u>		<u>Location</u>
		<u>Recording #</u>	<u>Page #</u>	<u>Recording #</u>	<u>Page #</u>	
AMC 431990	MONSTER-215	2015-2750				SEC26-T05S-R27E
AMC 431991	MONSTER-216	2015-2751				SEC26-T05S-R27E
AMC 431992	MONSTER-217	2015-2752				SEC26-T05S-R27E
AMC 431993	MONSTER-218	2015-2753				SEC26-T05S-R27E
AMC 431994	MONSTER-219	2015-2754				SEC23-T05S-R27E
AMC 431995	MONSTER-220	2015-2755				SEC23-T05S-R27E
AMC 431996	MONSTER-221	2015-2756				SEC23-T05S-R27E
AMC 431997	MONSTER-222	2015-2757				SEC23-T05S-R27E
AMC 431998	MONSTER-223	2015-2758				SEC23-T05S-R27E
AMC 431999	MONSTER-273	2015-2759				SEC21-T05S-R27E
AMC 432000	MONSTER-274	2015-2760				SEC21-T05S-R27E
AMC 432001	MONSTER-275	2015-2761				SEC21-T05S-R27E
AMC 432002	MONSTER-276	2015-2762				SEC21-T05S-R27E
AMC 432003	MONSTER-281	2015-2763				SEC21-T05S-R27E
AMC 432004	MONSTER-282	2015-2764				SEC21-T05S-R27E
AMC 432005	MONSTER-283	2015-2765				SEC21-T05S-R27E
AMC 432006	MONSTER-284	2015-2766				SEC21-T05S-R27E
AMC 432007	MONSTER-289	2015-2767				SEC21-T05S-R27E
AMC 432008	MONSTER-290	2015-2768				SEC21-T05S-R27E
AMC 432009	MONSTER-291	2015-2769				SEC21-T05S-R27E
AMC 432010	MONSTER-292	2015-2770				SEC21-T05S-R27E
AMC 432011	MONSTER-295	2015-2771				SEC20-T05S-R27E
AMC 432012	MONSTER-296	2015-2772				SEC20-T05S-R27E
AMC 432013	MONSTER-297	2015-2773				SEC20-T05S-R27E
AMC 432014	MONSTER-298	2015-2774				SEC20-T05S-R27E
AMC 432015	MONSTER-299	2015-2775				SEC20-T05S-R27E
AMC 432016	MONSTER-300	2015-2776				SEC20-T05S-R27E
AMC 432017	MONSTER-301	2015-2777				SEC20-T05S-R27E
AMC 432018	MONSTER-302	2015-2778				SEC20-T05S-R27E
AMC 432019	MONSTER-303	2015-2779				SEC20-T05S-R27E
AMC 432020	MONSTER-304	2015-2780				SEC20-T05S-R27E
AMC 432021	MONSTER-305	2015-2781				SEC20-T05S-R27E
AMC 432022	MONSTER-306	2015-2782				SEC20-T05S-R27E
AMC 432023	MONSTER-307	2015-2783				SEC20-T05S-R27E
AMC 432024	MONSTER-308	2015-2784				SEC20-T05S-R27E
AMC 432025	MONSTER-309	2015-2785				SEC20-T05S-R27E
AMC 432026	MONSTER-310	2015-2786				SEC20-T05S-R27E
AMC 432027	MONSTER-311	2015-2787				SEC20-T05S-R27E

Date: 7/25/2016

PHOENIX, ARIZONA  
 2016 AUG - 3 A 9 24

RECEIVED  
 BLM AZ STATE OFFICE

## EXHIBIT A

County: Graham

State: AZ

<u>BLM Serial #</u>	<u>Claim Name</u>	<u>Original Recording</u>		<u>Amended Recording</u>		<u>Location</u>
		<u>Recording #</u>	<u>Page #</u>	<u>Recording #</u>	<u>Page #</u>	
AMC 432028	MONSTER-312	2015-2789				SEC20-T05S-R27E
AMC 432029	MONSTER-313	2015-2790				SEC20-T05S-R27E
AMC 432030	MONSTER-314	2015-2791				SEC20-T05S-R27E
AMC 432031	MONSTER-315	2015-2792				SEC20-T05S-R27E
AMC 432032	MONSTER-316	2015-2793				SEC20-T05S-R27E
AMC 432033	MONSTER-317	2015-2794				SEC20-T05S-R27E
AMC 432034	MONSTER-318	2015-2795				SEC20-T05S-R27E
AMC 432035	MONSTER-319	2015-2796				SEC20-T05S-R27E
AMC 432036	MONSTER-320	2015-2797				SEC20-T05S-R27E
AMC 432037	MONSTER-321	2015-2798				SEC20-T05S-R27E
AMC 432038	MONSTER-322	2015-2799				SEC20-T05S-R27E
AMC 432039	MONSTER-323	2015-2800				SEC20-T05S-R27E
AMC 432040	MONSTER-324	2015-2801				SEC20-T05S-R27E
AMC 432041	MONSTER-325	2015-2802				SEC20-T05S-R27E
AMC 432042	MONSTER-326	2015-2803				SEC20-T05S-R27E
AMC 432043	MONSTER-327	2015-2804				SEC20-T05S-R27E
AMC 432044	MONSTER-328	2015-2805				SEC20-T05S-R27E
AMC 432045	MONSTER-329	2015-2806				SEC20-T05S-R27E
AMC 432046	MONSTER-330	2015-2807				SEC20-T05S-R27E
AMC 432120	Red Bull-361	2015-3021				SEC14-T05S-R25E
AMC 432121	Red Bull-362	2015-3022				SEC14-T05S-R25E
AMC 432122	Red Bull-363	2015-3023				SEC14-T05S-R25E
AMC 432123	Red Bull-364	2015-3024				SEC14-T05S-R25E
AMC 432124	Red Bull-365	2015-3025				SEC14-T05S-R25E
AMC 432125	Red Bull-366	2015-3026				SEC14-T05S-R25E
AMC 432126	Red Bull-367	2015-3027				SEC14-T05S-R25E
AMC 432127	Red Bull-368	2015-3028				SEC14-T05S-R25E
AMC 432128	Red Bull-369	2015-3029				SEC14-T05S-R25E
AMC 432129	Red Bull-370	2015-3030				SEC14-T05S-R25E
AMC 432130	Red Bull-371	2015-3031				SEC14-T05S-R25E
AMC 432131	Red Bull-372	2015-3032				SEC14-T05S-R25E
AMC 432132	Red Bull-373	2015-3033				SEC14-T05S-R25E
AMC 432133	Red Bull-374	2015-3034				SEC14-T05S-R25E
AMC 432134	Red Bull-375	2015-3035				SEC14-T05S-R25E
AMC 432135	Red Bull-376	2015-3036				SEC14-T06S-R25E
AMC 432136	Red Bull-377	2015-3037				SEC14-T05S-R25E
AMC 432137	Red Bull-378	2015-3038				SEC14-T05S-R25E
AMC 432138	Red Bull-433	2015-3039				SEC24-T05S-R25E

Date: 7/25/2016

Page 63

RECEIVED  
 BLM AZ STATE OFFICE  
 PHOENIX, ARIZONA  
 2016 AUG - 3 A 9 24

## EXHIBIT A

County: Graham

State: AZ

BLM Serial #	Claim Name	Original Recording		Amended Recording		Location
		Recording #	Page #	Recording #	Page #	
AMC 432139	Red Bull-434	2015-3040				SEC24-T05S-R25E
AMC 432140	Red Bull-435	2015-3041				SEC24-T05S-R25E
AMC 432141	Red Bull-436	2015-3042				SEC24-T05S-R25E
AMC 432142	Red Bull-437	2015-3043				SEC24-T05S-R25E
AMC 432143	Red Bull-438	2015-3044				SEC24-T05S-R25E
AMC 432144	Red Bull-439	2015-3045				SEC24-T05S-R25E
AMC 432145	Red Bull-440	2015-3046				SEC24-T05S-R25E
AMC 432146	Red Bull-441	2015-3047				SEC24-T05S-R25E
AMC 432147	Red Bull-442	2015-3048				SEC24-T05S-R25E
AMC 432148	Red Bull-443	2015-3049				SEC24-T05S-R25E
AMC 432149	Red Bull-444	2015-3050				SEC24-T05S-R25E
AMC 432150	Red Bull-445	2015-3051				SEC24-T05S-R25E
AMC 432151	Red Bull-446	2015-3052				SEC24-T05S-R25E
AMC 432152	Red Bull-447	2015-3053				SEC24-T05S-R25E
AMC 432153	Red Bull-448	2015-3054				SEC24-T05S-R25E
AMC 432154	Red Bull-449	2015-3055				SEC24-T05S-R25E
AMC 432155	Red Bull-450	2015-3056				SEC24-T05S-R25E
AMC 432156	Red Bull-451	2015-3057				SEC24-T05S-R25E
AMC 432157	Red Bull-452	2015-3058				SEC24-T05S-R25E
AMC 432158	Red Bull-453	2015-3059				SEC24-T05S-R25E
AMC 432159	Red Bull-454	2015-3060				SEC24-T05S-R25E
AMC 432160	Red Bull-455	2015-3061				SEC24-T05S-R25E
AMC 432161	Red Bull-456	2015-3062				SEC24-T05S-R25E
AMC 432162	Red Bull-457	2015-3063				SEC24-T05S-R25E
AMC 432163	Red Bull-458	2015-3064				SEC24-T05S-R25E
AMC 432164	Red Bull-459	2015-3065				SEC24-T05S-R25E
AMC 432165	Red Bull-460	2015-3066				SEC24-T05S-R25E
AMC 432166	Red Bull-461	2015-3067				SEC24-T05S-R25E
AMC 432167	Red Bull-462	2015-3068				SEC24-T05S-R25E
AMC 432168	Red Bull-463	2015-3069				SEC24-T05S-R25E
AMC 432169	Red Bull-464	2015-3070				SEC24-T05S-R25E
AMC 432170	Red Bull-465	2015-3071				SEC24-T05S-R25E
AMC 432171	Red Bull-466	2015-3072				SEC24-T05S-R25E
AMC 432172	Red Bull-467	2015-3073				SEC24-T05S-R25E
AMC 432173	Red Bull-468	2015-3074				SEC24-T05S-R25E
AMC 432174	Red Bull-485	2015-3075				SEC25-T05S-R26E
AMC 432175	Red Bull-486	2015-3076				SEC25-T05S-R26E
AMC 432176	Red Bull-487	2015-3077				SEC25-T05S-R26E

Date: 7/25/2016

RECEIVED  
 BLM AZ STATE OFFICE  
 2016 AUG - 3 A 9 24  
 PHOENIX, ARIZONA

Page 64

## EXHIBIT A

County: Graham

State: AZ

<u>BLM Serial #</u>	<u>Claim Name</u>	<u>Original Recording</u>		<u>Amended Recording</u>		<u>Location</u>
		<u>Recording #</u>	<u>Page #</u>	<u>Recording #</u>	<u>Page #</u>	
AMC 432177	Red Bull-488	2015-3078				SEC25-T05S-R26E
AMC 432178	Red Bull-489	2015-3079				SEC25-T05S-R26E
AMC 432179	Red Bull-490	2015-3080				SEC25-T05S-R26E
AMC 432180	Red Bull-491	2015-3081				SEC25-T05S-R26E
AMC 432181	Red Bull-492	2015-3082				SEC25-T05S-R26E
AMC 432182	Red Bull-530	2015-3083				SEC13-T05S-R26E
AMC 432183	Red Bull-531	2015-3084				SEC13-T05S-R26E
AMC 432184	Red Bull-533	2015-3085				SEC13-T05S-R26E
AMC 432185	Red Bull-534	2015-3086				SEC13-T05S-R26E
AMC 432186	Red Bull-536	2015-3087				SEC13-T05S-R26E
AMC 432187	Red Bull-537	2015-3088				SEC13-T05S-R26E
AMC 432188	Red Bull-539	2015-3089				SEC13-T05S-R26E
AMC 432189	Red Bull-540	2015-3090				SEC13-T05S-R26E
AMC 432190	Red Bull-542	2015-3091				SEC13-T05S-R26E
AMC 432191	Red Bull-543	2015-3092				SEC13-T05S-R26E
AMC 432192	Red Bull-545	2015-3093				SEC13-T05S-R26E
AMC 432193	Red Bull-546	2015-3094				SEC13-T05S-R26E
AMC 432194	Red Bull-548	2015-3095				SEC13-T05S-R26E
AMC 432195	Red Bull-549	2015-3096				SEC13-T05S-R26E
AMC 432196	Red Bull-551	2015-3097				SEC13-T05S-R26E
AMC 432197	Red Bull-552	2015-3098				SEC13-T05S-R26E
AMC 432198	Red Bull-554	2015-3099				SEC13-T05S-R26E
AMC 432199	Red Bull-555	2015-3100				SEC12-T05S-R26E
AMC 432200	Red Bull-556	2015-3101				SEC12-T05S-R26E
AMC 432201	Red Bull-557	2015-3102				SEC12-T05S-R26E
AMC 432202	Red Bull-558	2015-3103				SEC12-T05S-R26E
AMC 432203	Red Bull-559	2015-3104				SEC12-T05S-R26E
AMC 432204	Red Bull-560	2015-3105				SEC12-T05S-R26E
AMC 432205	Red Bull-561	2015-3106				SEC12-T05S-R26E
AMC 432206	Red Bull-562	2015-3107				SEC12-T05S-R26E
AMC 432207	Red Bull-563	2015-3108				SEC12-T05S-R26E
AMC 432208	Red Bull-564	2015-3109				SEC12-T05S-R26E
AMC 432209	Red Bull-565	2015-3110				SEC12-T05S-R26E
AMC 432210	Red Bull-566	2015-3111				SEC12-T05S-R26E
AMC 432211	Red Bull-567	2015-3112				SEC12-T05S-R26E
AMC 432212	Red Bull-568	2015-3113				SEC12-T05S-R26E
AMC 432213	Red Bull-569	2015-3114				SEC12-T05S-R26E
AMC 432214	Red Bull-570	2015-3115				SEC12-T05S-R26E

Date: 7/25/2016

RECEIVED  
BLM AZ STATE OFFICE

PHOENIX, ARIZONA  
2016 AUG - 3 A 9 24

## EXHIBIT A

County: Graham

State: AZ

<u>BLM Serial #</u>	<u>Claim Name</u>	<u>Original Recording</u>		<u>Amended Recording</u>		<u>Location</u>
		<u>Recording #</u>	<u>Page #</u>	<u>Recording #</u>	<u>Page #</u>	
AMC 432215	Red Bull-571	2015-3116				SEC12-T05S-R26E
AMC 432216	Red Bull-572	2015-3117				SEC12-T05S-R26E
AMC 432217	Red Bull-573	2015-3118				SEC12-T05S-R26E
AMC 432218	Red Bull-574	2015-3119				SEC12-T05S-R26E
AMC 432219	Red Bull-575	2015-3120				SEC12-T05S-R26E
AMC 432220	Red Bull-576	2015-3121				SEC12-T05S-R26E
AMC 432221	Red Bull-577	2015-3122				SEC12-T05S-R26E
AMC 432222	Red Bull-578	2015-3123				SEC12-T05S-R26E
AMC 432223	Red Bull-579	2015-3124				SEC12-T05S-R26E
AMC 432224	Red Bull-580	2015-3125				SEC12-T05S-R26E
AMC 432225	Red Bull-581	2015-3126				SEC12-T05S-R26E
AMC 432226	Red Bull-582	2015-3127				SEC12-T05S-R26E
AMC 432227	Red Bull-583	2015-3128				SEC12-T05S-R26E
AMC 432228	Red Bull-584	2015-3129				SEC12-T05S-R26E
AMC 432229	Red Bull-585	2015-3130				SEC12-T05S-R26E
AMC 432230	Red Bull-586	2015-3131				SEC12-T05S-R26E
AMC 432231	Red Bull-587	2015-3132				SEC12-T05S-R26E
AMC 432232	Red Bull-588	2015-3133				SEC12-T05S-R26E
AMC 432233	Red Bull-589	2015-3134				SEC12-T05S-R26E
AMC 432234	Red Bull-590	2015-3135				SEC12-T05S-R26E
AMC 432235	Red Bull-591	2015-3136				SEC12-T05S-R26E
AMC 432241	MONSTER-367	2015-3138				SEC18-T05S-R27E
AMC 432242	MONSTER-368	2015-3139				SEC18-T05S-R27E
AMC 432243	MONSTER-369	2015-3140				SEC18-T05S-R27E
AMC 432244	MONSTER-370	2015-3141				SEC18-T05S-R27E
AMC 432245	MONSTER-371	2015-3142				SEC18-T05S-R27E
AMC 432246	MONSTER-372	2015-3143				SEC18-T05S-R27E
AMC 432247	MONSTER-373	2015-3144				SEC18-T05S-R27E
AMC 432248	MONSTER-374	2015-3145				SEC18-T05S-R27E
AMC 432249	MONSTER-375	2015-3146				SEC18-T05S-R27E
AMC 432250	MONSTER-376	2015-3147				SEC18-T05S-R27E
AMC 432251	MONSTER-377	2015-3148				SEC18-T05S-R27E
AMC 432252	MONSTER-378	2015-3149				SEC18-T05S-R27E
AMC 432253	MONSTER-379	2015-3150				SEC18-T05S-R27E
AMC 432254	MONSTER-380	2015-3151				SEC18-T05S-R27E
AMC 432255	MONSTER-381	2015-3152				SEC18-T05S-R27E
AMC 432256	MONSTER-382	2015-3153				SEC18-T05S-R27E
AMC 432257	MONSTER-383	2015-3154				SEC18-T05S-R27E

Date: 7/25/2016

RECEIVED  
BLM AZ STATE OFFICE  
2016 AUG - 3 A 9 24

## EXHIBIT A

County: Graham

State: AZ

<u>BLM Serial #</u>	<u>Claim Name</u>	<u>Original Recording</u>		<u>Amended Recording</u>		<u>Location</u>
		<u>Recording #</u>	<u>Page #</u>	<u>Recording #</u>	<u>Page #</u>	
AMC 432258	MONSTER-384	2015-3155				SEC18-T05S-R27E
AMC 432259	MONSTER-385	2015-3156				SEC18-T05S-R27E
AMC 432260	MONSTER-386	2015-3157				SEC18-T05S-R27E
AMC 432261	MONSTER-387	2015-3158				SEC18-T05S-R27E
AMC 432262	MONSTER-388	2015-3159				SEC18-T05S-R27E
AMC 432263	MONSTER-389	2015-3160				SEC18-T05S-R27E
AMC 432264	MONSTER-390	2015-3161				SEC18-T05S-R27E
AMC 432265	MONSTER-391	2015-3162				SEC18-T05S-R27E
AMC 432266	MONSTER-392	2015-3163				SEC18-T05S-R27E
AMC 432267	MONSTER-393	2015-3164				SEC18-T05S-R27E
AMC 432268	MONSTER-394	2015-3165				SEC17-T05S-R27E
AMC 432269	MONSTER-395	2015-3166				SEC17-T05S-R27E
AMC 432270	MONSTER-396	2015-3167				SEC17-T05S-R27E
AMC 432271	MONSTER-397	2015-3168				SEC17-T05S-R27E
AMC 432272	MONSTER-398	2015-3169				SEC17-T05S-R27E
AMC 432273	MONSTER-399	2015-3170				SEC17-T05S-R27E
AMC 432274	MONSTER-400	2015-3171				SEC17-T05S-R27E
AMC 432275	MONSTER-401	2015-3172				SEC17-T05S-R27E
AMC 432276	MONSTER-402	2015-3173				SEC17-T05S-R27E
AMC 432277	MONSTER-403	2015-3174				SEC17-T05S-R27E
AMC 432278	MONSTER-404	2015-3175				SEC17-T05S-R27E
AMC 432279	MONSTER-405	2015-3176				SEC17-T05S-R27E
AMC 432280	MONSTER-406	2015-3177				SEC17-T05S-R27E
AMC 432281	MONSTER-407	2015-3178				SEC17-T05S-R27E
AMC 432282	MONSTER-408	2015-3179				SEC17-T05S-R27E
AMC 432283	MONSTER-409	2015-3180				SEC17-T05S-R27E
AMC 432284	MONSTER-410	2015-3181				SEC17-T05S-R27E
AMC 432285	MONSTER-411	2015-3182				SEC17-T05S-R27E
AMC 432286	MONSTER-412	2015-3183				SEC17-T05S-R27E
AMC 432287	MONSTER-413	2015-3184				SEC17-T05S-R27E
AMC 432288	MONSTER-414	2015-3185				SEC17-T05S-R27E
AMC 432289	MONSTER-415	2015-3186				SEC17-T05S-R27E
AMC 432290	MONSTER-416	2015-3187				SEC17-T05S-R27E
AMC 432291	MONSTER-417	2015-3188				SEC17-T05S-R27E
AMC 432292	MONSTER-418	2015-3189				SEC17-T05S-R27E
AMC 432293	MONSTER-419	2015-3190				SEC17-T05S-R27E
AMC 432294	MONSTER-420	2015-3191				SEC17-T05S-R27E
AMC 432295	MONSTER-475	2015-3182				SEC10-T05S-R27E

Date: 7/25/2016

RECEIVED  
 BLM AZ STATE OFFICE  
 2016 AUG - 3 A 9 24  
 PHOENIX, ARIZONA



## EXHIBIT A

County: Graham

State: AZ

<u>BLM Serial #</u>	<u>Claim Name</u>	<u>Original Recording</u>		<u>Amended Recording</u>		<u>Location</u>
		<u>Recording #</u>	<u>Page #</u>	<u>Recording #</u>	<u>Page #</u>	
AMC 432296	MONSTER-476	2015-3183				SEC10-T05S-R27E
AMC 432297	MONSTER-477	2015-3184				SEC10-T05S-R27E
AMC 432298	MONSTER-478	2015-3185				SEC10-T05S-R27E
AMC 432299	MONSTER-479	2015-3186				SEC10-T05S-R27E
AMC 432300	MONSTER-480	2015-3187				SEC10-T05S-R27E
AMC 432301	MONSTER-481	2015-3188				SEC10-T05S-R27E
AMC 432302	MONSTER-482	2015-3189				SEC10-T05S-R27E
AMC 432303	MONSTER-483	2015-3190				SEC09-T05S-R27E
AMC 432304	MONSTER-484	2015-3191				SEC09-T05S-R27E
AMC 432305	MONSTER-485	2015-3192				SEC09-T05S-R27E
AMC 432306	MONSTER-486	2015-3193				SEC09-T05S-R27E
AMC 432307	MONSTER-487	2015-3194				SEC09-T05S-R27E
AMC 432308	MONSTER-488	2015-3195				SEC09-T05S-R27E
AMC 432309	MONSTER-489	2015-3196				SEC09-T05S-R27E
AMC 432310	MONSTER-490	2015-3197				SEC09-T05S-R27E
AMC 432311	MONSTER-491	2015-3198				SEC09-T05S-R27E
AMC 432312	MONSTER-492	2015-3199				SEC09-T05S-R27E
AMC 432313	MONSTER-493	2015-3200				SEC09-T05S-R27E
AMC 432314	MONSTER-494	2015-3201				SEC09-T05S-R27E
AMC 432315	MONSTER-495	2015-3202				SEC09-T05S-R27E
AMC 432316	MONSTER-496	2015-3203				SEC09-T05S-R27E
AMC 432317	MONSTER-497	2015-3204				SEC09-T05S-R27E
AMC 432318	MONSTER-498	2015-3205				SEC09-T05S-R27E
AMC 432319	MONSTER-499	2015-3206				SEC09-T05S-R27E
AMC 432320	MONSTER-500	2015-3207				SEC09-T05S-R27E
AMC 432321	MONSTER-501	2015-3208				SEC09-T05S-R27E
AMC 432322	MONSTER-502	2015-3209				SEC09-T05S-R27E
AMC 432323	MONSTER-503	2015-3210				SEC09-T05S-R27E
AMC 432324	MONSTER-504	2015-3211				SEC09-T05S-R27E
AMC 432325	MONSTER-505	2015-3212				SEC09-T05S-R27E
AMC 432326	MONSTER-506	2015-3213				SEC09-T05S-R27E
AMC 432327	MONSTER-507	2015-3214				SEC09-T05S-R27E
AMC 432328	MONSTER-508	2015-3215				SEC09-T05S-R27E
AMC 432329	MONSTER-509	2015-3216				SEC09-T05S-R27E
AMC 432330	MONSTER-510	2015-3217				SEC08-T05S-R27E
AMC 432331	MONSTER-511	2015-3218				SEC08-T05S-R27E
AMC 432332	MONSTER-512	2015-3219				SEC08-T05S-R27E
AMC 432333	MONSTER-513	2015-3220				SEC08-T05S-R27E

Date: 7/25/2016

RECEIVED  
BLM AZ STATE OFFICE  
2016 AUG - 3 9 25  
PHOENIX, ARIZONA

## EXHIBIT A

County: Graham

State: AZ

<u>BLM Serial #</u>	<u>Claim Name</u>	<u>Original Recording</u>		<u>Amended Recording</u>		<u>Location</u>
		<u>Recording #</u>	<u>Page #</u>	<u>Recording #</u>	<u>Page #</u>	
AMC 432334	MONSTER-514	2015-3221				SEC08-T05S-R27E
AMC 432335	MONSTER-515	2015-3222				SEC08-T05S-R27E
AMC 432336	MONSTER-516	2015-3223				SEC08-T05S-R27E
AMC 432337	MONSTER-517	2015-3224				SEC08-T05S-R27E
AMC 432338	MONSTER-518	2015-3225				SEC08-T05S-R27E
AMC 432339	MONSTER-519	2015-3226				SEC08-T05S-R27E
AMC 432340	MONSTER-520	2015-3227				SEC08-T05S-R27E
AMC 432341	MONSTER-521	2015-3228				SEC08-T05S-R27E
AMC 432342	MONSTER-522	2015-3229				SEC08-T05S-R27E
AMC 432343	MONSTER-523	2015-3230				SEC08-T05S-R27E
AMC 432344	MONSTER-524	2015-3231				SEC08-T05S-R27E
AMC 432345	MONSTER-525	2015-3232				SEC08-T05S-R27E
AMC 432346	MONSTER-526	2015-3233				SEC08-T05S-R27E
AMC 432347	MONSTER-527	2015-3234				SEC08-T05S-R27E
AMC 432348	MONSTER-528	2015-3235				SEC08-T05S-R27E
AMC 432349	MONSTER-529	2015-3236				SEC08-T05S-R27E
AMC 432350	MONSTER-530	2015-3237				SEC08-T05S-R27E
AMC 432351	MONSTER-531	2015-3238				SEC08-T05S-R27E
AMC 432352	MONSTER-532	2015-3239				SEC08-T05S-R27E
AMC 432353	MONSTER-533	2015-3240				SEC08-T05S-R27E
AMC 432354	MONSTER-534	2015-3241				SEC08-T05S-R27E
AMC 432355	MONSTER-535	2015-3242				SEC08-T05S-R27E
AMC 432356	MONSTER-536	2015-3243				SEC08-T05S-R27E
AMC 432357	MONSTER-537	2015-3244				SEC07-T05S-R27E
AMC 432358	MONSTER-538	2015-3245				SEC07-T05S-R27E
AMC 432359	MONSTER-539	2015-3246				SEC07-T05S-R27E
AMC 432360	MONSTER-540	2015-3247				SEC07-T05S-R27E
AMC 432361	MONSTER-541	2015-3248				SEC07-T05S-R27E
AMC 432362	MONSTER-542	2015-3249				SEC07-T05S-R27E
AMC 432363	MONSTER-543	2015-3250				SEC07-T05S-R27E
AMC 432364	MONSTER-544	2015-3251				SEC07-T05S-R27E
AMC 432365	MONSTER-545	2015-3252				SEC07-T05S-R27E
AMC 432366	MONSTER-546	2015-3253				SEC07-T05S-R27E
AMC 432367	MONSTER-547	2015-3254				SEC07-T05S-R27E
AMC 432368	MONSTER-548	2015-3255				SEC07-T05S-R27E
AMC 432369	MONSTER-549	2015-3256				SEC07-T05S-R27E
AMC 432370	MONSTER-550	2015-3257				SEC07-T05S-R27E
AMC 432371	MONSTER-551	2015-3258				SEC07-T05S-R27E

Date: 7/25/2016

RECEIVED  
BLM AZ STATE OFFICE  
2016 AUG - 3 A 9 28  
PHOENIX, ARIZONA

## EXHIBIT A

County: Graham

State: AZ

BLM Serial #	Claim Name	Original Recording		Amended Recording		Location
		Recording #	Page #	Recording #	Page #	
AMC 432372	MONSTER-552	2015-3259				SEC07-T05S-R27E
AMC 432373	MONSTER-553	2015-3260				SEC07-T05S-R27E
AMC 432374	MONSTER-554	2015-3261				SEC07-T05S-R27E
AMC 432375	MONSTER-555	2015-3262				SEC07-T05S-R27E
AMC 432376	MONSTER-556	2015-3263				SEC07-T05S-R27E
AMC 432377	MONSTER-557	2015-3264				SEC07-T05S-R27E
AMC 432378	MONSTER-558	2015-3265				SEC07-T05S-R27E
AMC 432379	MONSTER-559	2015-3266				SEC07-T05S-R27E
AMC 432380	MONSTER-560	2015-3267				SEC07-T05S-R27E
AMC 432381	MONSTER-561	2015-3268				SEC07-T05S-R27E
AMC 432382	MONSTER-562	2015-3269				SEC07-T05S-R27E
AMC 432383	MONSTER-563	2015-3270				SEC07-T05S-R27E
AMC 432384	MONSTER-589	2015-3281				SEC08-T05S-R27E
AMC 432385	MONSTER-590	2015-3282				SEC05-T05S-R27E
AMC 432386	MONSTER-591	2015-3283				SEC04-T05S-R27E
AMC 432387	MONSTER-592	2015-3284				SEC04-T05S-R27E
AMC 432388	MONSTER-593	2015-3285				SEC04-T05S-R27E
AMC 432389	MONSTER-594	2015-3286				SEC04-T05S-R27E
AMC 432390	MONSTER-595	2015-3287				SEC04-T05S-R27E
AMC 432391	MONSTER-596	2015-3288				SEC04-T05S-R27E
AMC 432392	MONSTER-597	2015-3289				SEC04-T05S-R27E
AMC 432393	MONSTER-598	2015-3290				SEC04-T05S-R27E
AMC 432394	MONSTER-599	2015-3291				SEC04-T05S-R27E
AMC 432395	MONSTER-600	2015-3292				SEC04-T05S-R27E
AMC 432396	MONSTER-601	2015-3293				SEC04-T05S-R27E
AMC 432397	MONSTER-602	2015-3294				SEC04-T05S-R27E
AMC 432398	MONSTER-603	2015-3295				SEC04-T05S-R27E
AMC 432399	MONSTER-604	2015-3296				SEC04-T05S-R27E
AMC 432400	MONSTER-605	2015-3297				SEC04-T05S-R27E
AMC 432401	MONSTER-606	2015-3298				SEC04-T05S-R27E
AMC 432402	MONSTER-607	2015-3299				SEC04-T05S-R27E
AMC 432403	MONSTER-608	2015-3300				SEC04-T05S-R27E
AMC 432404	MONSTER-609	2015-3301				SEC04-T05S-R27E
AMC 432405	MONSTER-610	2015-3302				SEC04-T05S-R27E
AMC 432406	MONSTER-611	2015-3303				SEC04-T05S-R27E
AMC 432407	MONSTER-612	2015-3304				SEC04-T05S-R27E
AMC 432408	MONSTER-613	2015-3305				SEC04-T05S-R27E
AMC 432409	MONSTER-614	2015-3306				SEC04-T05S-R27E

Date: 7/25/2016

Page 70

RECEIVED  
BLM AZ STATE OFFICE  
2016 AUG - 3 A 9 28  
PHOENIX, ARIZONA

## EXHIBIT A

County: Graham

State: AZ

BLM Serial #	Claim Name	Original Recording		Amended Recording		Location
		Recording #	Page #	Recording #	Page #	
AMC 432410	MONSTER-615	2015-3307				SEC04-T05S-R27E
AMC 432411	MONSTER-616	2015-3308				SEC04-T05S-R27E
AMC 432412	MONSTER-617	2015-3309				SEC04-T05S-R27E
AMC 432413	MONSTER-618	2015-3310				SEC04-T05S-R27E
AMC 432414	MONSTER-619	2015-3311				SEC04-T05S-R27E
AMC 432415	MONSTER-620	2015-3312				SEC04-T05S-R27E
AMC 432416	MONSTER-621	2015-3313				SEC04-T05S-R27E
AMC 432417	MONSTER-622	2015-3314				SEC04-T05S-R27E
AMC 432443	MONSTER-564	2015-3476				SEC06-T05S-R27E
AMC 432444	MONSTER-565	2015-3477				SEC06-T05S-R27E
AMC 432445	MONSTER-566	2015-3478				SEC06-T05S-R27E
AMC 432446	MONSTER-567	2015-3479				SEC06-T05S-R27E
AMC 432447	MONSTER-568	2015-3480				SEC06-T05S-R27E
AMC 432448	MONSTER-569	2015-3481				SEC06-T05S-R27E
AMC 432449	MONSTER-570	2015-3482				SEC06-T05S-R27E
AMC 432450	MONSTER-571	2015-3483				SEC06-T05S-R27E
AMC 432451	MONSTER-572	2015-3484				SEC06-T05S-R27E
AMC 432452	MONSTER-573	2015-3485				SEC06-T05S-R27E
AMC 432453	MONSTER-574	2015-3486				SEC06-T05S-R27E
AMC 432454	MONSTER-575	2015-3487				SEC06-T05S-R27E
AMC 432455	MONSTER-576	2015-3488				SEC06-T05S-R27E
AMC 432456	MONSTER-577	2015-3489				SEC06-T05S-R27E
AMC 432457	MONSTER-578	2015-3490				SEC06-T05S-R27E
AMC 432458	MONSTER-579	2015-3491				SEC06-T05S-R27E
AMC 432459	MONSTER-580	2015-3492				SEC06-T05S-R27E
AMC 432460	MONSTER-581	2015-3493				SEC06-T05S-R27E
AMC 432461	MONSTER-582	2015-3494				SEC06-T05S-R27E
AMC 432462	MONSTER-583	2015-3495				SEC06-T05S-R27E
AMC 432463	MONSTER-584	2015-3496				SEC05-T05S-R27E
AMC 432464	MONSTER-585	2015-3497				SEC05-T05S-R27E
AMC 432465	MONSTER-586	2015-3498				SEC08-T05S-R27E
AMC 432466	MONSTER-587	2015-3499				SEC08-T05S-R27E
AMC 432467	MONSTER-588	2015-3500				SEC08-T05S-R27E
AMC 432486	Red Bull-493	2015-3656				SEC24-T05S-R26E
AMC 432487	Red Bull-494	2015-3657				SEC24-T05S-R26E
AMC 432488	Red Bull-495	2015-3658				SEC24-T05S-R26E
AMC 432489	Red Bull-496	2015-3659				SEC24-T05S-R26E
AMC 432490	Red Bull-497	2015-3660				SEC24-T05S-R26E

Date: 7/25/2016

RECEIVED  
BLM AZ STATE OFFICE

PHOENIX, ARIZONA  
2016 AUG - 3 A 9 26

## EXHIBIT A

County: Graham

State: AZ

<u>BLM Serial #</u>	<u>Claim Name</u>	<u>Original Recording</u>		<u>Amended Recording</u>		<u>Location</u>
		<u>Recording #</u>	<u>Page #</u>	<u>Recording #</u>	<u>Page #</u>	
AMC 432491	Red Bull-498	2015-3661				SEC24-T05S-R26E
AMC 432492	Red Bull-499	2015-3662				SEC24-T05S-R26E
AMC 432493	Red Bull-500	2015-3663				SEC24-T05S-R26E
AMC 432494	Red Bull-501	2015-3664				SEC24-T05S-R26E
AMC 432495	Red Bull-502	2015-3665				SEC24-T05S-R26E
AMC 432496	Red Bull-503	2015-3666				SEC24-T05S-R26E
AMC 432497	Red Bull-504	2015-3667				SEC24-T05S-R26E
AMC 432498	Red Bull-505	2015-3668				SEC24-T05S-R26E
AMC 432499	Red Bull-506	2015-3669				SEC24-T05S-R26E
AMC 432500	Red Bull-507	2015-3670				SEC24-T05S-R26E
AMC 432501	Red Bull-508	2015-3671				SEC24-T05S-R26E
AMC 432502	Red Bull-509	2015-3672				SEC24-T05S-R26E
AMC 432503	Red Bull-510	2015-3673				SEC24-T05S-R26E
AMC 432504	Red Bull-511	2015-3674				SEC24-T05S-R26E
AMC 432505	Red Bull-512	2015-3675				SEC24-T05S-R26E
AMC 432506	Red Bull-513	2015-3676				SEC24-T05S-R26E
AMC 432507	Red Bull-514	2015-3677				SEC24-T05S-R26E
AMC 432508	Red Bull-515	2015-3678				SEC24-T05S-R26E
AMC 432509	Red Bull-516	2015-3679				SEC24-T05S-R26E
AMC 432510	Red Bull-517	2015-3680				SEC24-T05S-R26E
AMC 432511	Red Bull-518	2015-3681				SEC24-T05S-R26E
AMC 432512	Red Bull-519	2015-3682				SEC24-T05S-R26E
AMC 432513	Red Bull-520	2015-3683				SEC24-T05S-R26E
AMC 432514	Red Bull-521	2015-3684				SEC24-T05S-R26E
AMC 432515	Red Bull-522	2015-3685				SEC24-T05S-R26E
AMC 432516	Red Bull-523	2015-3686				SEC24-T05S-R26E
AMC 432517	Red Bull-524	2015-3687				SEC24-T05S-R26E
AMC 432518	Red Bull-525	2015-3688				SEC24-T05S-R26E
AMC 432519	Red Bull-526	2015-3689				SEC24-T05S-R26E
AMC 432520	Red Bull-527	2015-3690				SEC24-T05S-R26E
AMC 432521	Red Bull-528	2015-3691				SEC24-T05S-R26E
AMC 432522	Red Bull-529	2015-3692				SEC13-T05S-R26E
AMC 432523	Red Bull-532	2015-3693				SEC13-T05S-R26E
AMC 432524	Red Bull-535	2015-3694				SEC13-T05S-R26E
AMC 432525	Red Bull-538	2015-3695				SEC13-T05S-R26E
AMC 432526	Red Bull-541	2015-3696				SEC13-T05S-R26E
AMC 432527	Red Bull-544	2015-3697				SEC13-T05S-R26E
AMC 432528	Red Bull-547	2015-3698				SEC13-T05S-R26E

Date: 7/25/2016

RECEIVED  
BLM AZ STATE OFFICE  
2016 AUG - 3 A 9 26  
PHOENIX, ARIZONA

## EXHIBIT A

County: Graham

State: AZ

<u>BLM Serial #</u>	<u>Claim Name</u>	<u>Original Recording</u>		<u>Amended Recording</u>		<u>Location</u>
		<u>Recording #</u>	<u>Page #</u>	<u>Recording #</u>	<u>Page #</u>	
AMC 432529	Red Bull-550	2015-3699				SEC13-T05S-R26E
AMC 432530	Red Bull-553	2015-3700				SEC13-T05S-R26E
AMC 432531	Red Bull-592	2015-3701				SEC01-T05S-R26E
AMC 432532	Red Bull-593	2015-3702				SEC01-T05S-R26E
AMC 432533	Red Bull-594	2015-3703				SEC01-T05S-R26E
AMC 432534	Red Bull-595	2015-3704				SEC01-T05S-R26E
AMC 432535	Red Bull-596	2015-3705				SEC01-T05S-R26E
AMC 432536	Red Bull-597	2015-3706				SEC01-T05S-R26E
AMC 432537	Red Bull-598	2015-3707				SEC01-T05S-R26E
AMC 432538	Red Bull-599	2015-3708				SEC01-T05S-R26E
AMC 432539	Red Bull-600	2015-3709				SEC01-T05S-R26E
AMC 432540	Red Bull-601	2015-3710				SEC01-T05S-R26E
AMC 432541	Red Bull-602	2015-3711				SEC01-T05S-R26E
AMC 432542	Red Bull-603	2015-3712				SEC01-T05S-R26E
AMC 432543	Red Bull-604	2015-3713				SEC01-T05S-R26E
AMC 432544	Red Bull-605	2015-3714				SEC23-T05S-R26E
AMC 432545	Red Bull-606	2015-3715				SEC23-T05S-R26E
AMC 432546	Red Bull-607	2015-3716				SEC23-T05S-R26E
AMC 432547	Red Bull-608	2015-3717				SEC23-T05S-R26E
AMC 432548	Red Bull-609	2015-3718				SEC23-T05S-R26E
AMC 432549	Red Bull-610	2015-3719				SEC23-T05S-R26E
AMC 432550	Red Bull-611	2015-3720				SEC23-T05S-R26E
AMC 432551	Red Bull-612	2015-3721				SEC23-T05S-R25E
AMC 432552	Red Bull-613	2015-3722				SEC14-T05S-R26E
AMC 432553	Red Bull-614	2015-3723				SEC14-T05S-R26E
AMC 432554	Red Bull-615	2015-3724				SEC14-T05S-R26E
AMC 432555	Red Bull-616	2015-3725				SEC14-T05S-R26E
AMC 432556	Red Bull-617	2015-3726				SEC14-T05S-R26E
AMC 432557	Red Bull-618	2015-3727				SEC14-T05S-R26E
AMC 432558	Red Bull-619	2015-3728				SEC14-T05S-R26E
AMC 432559	Red Bull-620	2015-3729				SEC14-T05S-R26E
AMC 432560	Red Bull-621	2015-3730				SEC14-T05S-R26E
AMC 432561	Red Bull-622	2015-3731				SEC14-T05S-R26E
AMC 432562	Red Bull-623	2015-3732				SEC14-T05S-R26E
AMC 432563	Red Bull-624	2015-3733				SEC14-T05S-R26E
AMC 432564	Red Bull-625	2015-3734				SEC14-T05S-R26E
AMC 432565	Red Bull-626	2015-3735				SEC14-T05S-R26E
AMC 432566	Red Bull-627	2015-3736				SEC14-T05S-R26E

Date: 7/25/2016

RECEIVED  
BLM AZ STATE OFFICE  
2016 AUG - 3  
PHOENIX, ARIZONA

## EXHIBIT A

County: Graham

State: AZ

<u>BLM Serial #</u>	<u>Claim Name</u>	<u>Original Recording</u>		<u>Amended Recording</u>		<u>Location</u>
		<u>Recording #</u>	<u>Page #</u>	<u>Recording #</u>	<u>Page #</u>	
AMC 432567	Red Bull-628	2015-3737				SEC14-T05S-R26E
AMC 432568	Red Bull-629	2015-3738				SEC14-T05S-R26E
AMC 432569	Red Bull-630	2015-3739				SEC14-T05S-R26E
AMC 432570	Red Bull-631	2015-3740				SEC14-T05S-R26E
AMC 432571	Red Bull-632	2015-3741				SEC14-T05S-R26E
AMC 432572	Red Bull-633	2015-3742				SEC14-T05S-R26E
AMC 432573	Red Bull-634	2015-3743				SEC14-T05S-R26E
AMC 432574	Red Bull-635	2015-3744				SEC14-T05S-R26E
AMC 432575	Red Bull-636	2015-3745				SEC14-T05S-R26E
AMC 432576	Red Bull-637	2015-3746				SEC14-T05S-R26E
AMC 432577	Red Bull-638	2015-3747				SEC14-T05S-R26E
AMC 432578	Red Bull-639	2015-3748				SEC14-T05S-R26E
AMC 432579	Red Bull-640	2015-3749				SEC14-T05S-R26E
AMC 432580	Red Bull-641	2015-3750				SEC11-T05S-R26E
AMC 432581	Red Bull-642	2015-3751				SEC11-T05S-R26E
AMC 432582	Red Bull-643	2015-3752				SEC11-T05S-R26E
AMC 432583	Red Bull-644	2015-3753				SEC11-T05S-R26E
AMC 432584	Red Bull-645	2015-3754				SEC11-T05S-R26E
AMC 432585	Red Bull-646	2015-3755				SEC11-T05S-R26E
AMC 432586	Red Bull-647	2015-3756				SEC11-T05S-R26E
AMC 432587	Red Bull-648	2015-3757				SEC11-T05S-R26E
AMC 432588	Red Bull-649	2015-3758				SEC11-T05S-R26E
AMC 432589	Red Bull-650	2015-3759				SEC11-T05S-R26E
AMC 432590	Red Bull-651	2015-3760				SEC11-T05S-R26E
AMC 432591	Red Bull-652	2015-3761				SEC11-T05S-R26E
AMC 432592	Red Bull-653	2015-3762				SEC11-T05S-R26E
AMC 432593	Red Bull-654	2015-3763				SEC11-T05S-R26E
AMC 432594	Red Bull-655	2015-3764				SEC11-T05S-R26E
AMC 432595	Red Bull-656	2015-3765				SEC11-T05S-R26E
AMC 432596	Red Bull-657	2015-3766				SEC11-T05S-R26E
AMC 432597	Red Bull-658	2015-3767				SEC11-T05S-R26E
AMC 432598	Red Bull-659	2015-3768				SEC11-T05S-R26E
AMC 432599	Red Bull-660	2015-3769				SEC11-T05S-R26E
AMC 432600	Red Bull-661	2015-3770				SEC11-T05S-R26E
AMC 432601	Red Bull-662	2015-3771				SEC11-T05S-R26E
AMC 432602	Red Bull-663	2015-3772				SEC11-T05S-R26E
AMC 432603	Red Bull-664	2015-3773				SEC11-T05S-R26E
AMC 432604	Red Bull-665	2015-3774				SEC11-T05S-R26E

Date: 7/25/2016

Page 74

RECEIVED  
BLM AZ STATE OFFICE  
2016 AUG - 3 A 9 27  
PHOENIX, ARIZONA

## EXHIBIT A

County: Graham

State: AZ

<u>BLM Serial #</u>	<u>Claim Name</u>	<u>Original Recording</u>		<u>Amended Recording</u>		<u>Location</u>
		<u>Recording #</u>	<u>Page #</u>	<u>Recording #</u>	<u>Page #</u>	
AMC 432605	Red Bull-666	2015-3775				SEC11-T05S-R26E
AMC 432606	Red Bull-667	2015-3776				SEC11-T05S-R26E
AMC 432607	Red Bull-668	2015-3777				SEC11-T05S-R26E
AMC 432608	Red Bull-669	2015-3778				SEC11-T05S-R26E
AMC 432609	Red Bull-670	2015-3779				SEC11-T05S-R26E
AMC 432610	Red Bull-671	2015-3780				SEC11-T05S-R26E
AMC 432611	Red Bull-672	2015-3781				SEC11-T05S-R26E
AMC 432612	Red Bull-673	2015-3782				SEC11-T05S-R26E
AMC 432613	Red Bull-674	2015-3783				SEC11-T05S-R26E
AMC 432614	Red Bull-675	2015-3784				SEC11-T05S-R26E
AMC 432615	Red Bull-676	2015-3785				SEC11-T05S-R26E
AMC 432616	Red Bull-677	2015-3786				SEC11-T05S-R26E
AMC 432617	Red Bull-678	2015-3787				SEC11-T05S-R26E
AMC 432618	Red Bull-679	2015-3788				SEC11-T05S-R26E
AMC 432619	Red Bull-680	2015-3789				SEC11-T05S-R26E
AMC 432621	ROCKSTAR 284	2015-3867				SEC06-T06S-R27E
AMC 432622	ROCKSTAR 285	2015-3868				SEC06-T06S-R25E
AMC 432623	ROCKSTAR 286	2015-3869				SEC06-T06S-R25E
AMC 432624	ROCKSTAR 287	2015-3870				SEC06-T06S-R25E
AMC 432625	ROCKSTAR 288	2015-3871				SEC06-T06S-R25E
AMC 432626	ROCKSTAR 289	2015-3872				SEC06-T06S-R25E
AMC 432627	ROCKSTAR 290	2015-3873				SEC06-T06S-R25E
AMC 432628	ROCKSTAR 291	2015-3874				SEC06-T06S-R25E
AMC 432629	ROCKSTAR 292	2015-3875				SEC06-T06S-R25E
AMC 432630	ROCKSTAR 293	2015-3876				SEC06-T06S-R25E
AMC 432631	ROCKSTAR 294	2015-3877				SEC06-T06S-R25E
AMC 432632	ROCKSTAR 295	2015-3878				SEC06-T06S-R25E
AMC 432633	ROCKSTAR 296	2015-3879				SEC06-T06S-R25E
AMC 432634	ROCKSTAR 297	2015-3880				SEC06-T06S-R25E
AMC 432635	ROCKSTAR 298	2015-3881				SEC06-T06S-R25E
AMC 432636	ROCKSTAR 299	2015-3882				SEC06-T06S-R25E
AMC 432637	ROCKSTAR 300	2015-3883				SEC06-T06S-R25E
AMC 432638	ROCKSTAR 301	2015-3884				SEC06-T06S-R25E
AMC 432639	ROCKSTAR 302	2015-3885				SEC06-T06S-R25E
AMC 432640	ROCKSTAR 303	2015-3886				SEC06-T06S-R25E
AMC 432641	ROCKSTAR 304	2015-3887				SEC06-T06S-R25E
AMC 432642	ROCKSTAR 305	2015-3888				SEC06-T06S-R25E
AMC 432643	ROCKSTAR 306	2015-3889				SEC06-T06S-R25E

Date: 7/25/2016

Page 75

RECEIVED  
BLM AZ STATE OFFICE  
2016 AUG - 3 A 9 27  
PHOENIX, ARIZONA



## EXHIBIT A

County: Graham

State: AZ

<u>BLM Serial #</u>	<u>Claim Name</u>	<u>Original Recording</u>		<u>Amended Recording</u>		<u>Location</u>
		<u>Recording #</u>	<u>Page #</u>	<u>Recording #</u>	<u>Page #</u>	
AMC 432644	ROCKSTAR 307	2015-3890				SEC06-T06S-R25E
AMC 432645	ROCKSTAR 308	2015-3891				SEC06-T06S-R25E
AMC 432646	ROCKSTAR 309	2015-3892				SEC06-T06S-R25E
AMC 432647	ROCKSTAR 310	2015-3893				SEC06-T06S-R25E
AMC 432648	ROCKSTAR 311	2015-3894				SEC06-T06S-R25E
AMC 432649	ROCKSTAR 312	2015-3895				SEC06-T06S-R25E
AMC 432650	ROCKSTAR 313	2015-3896				SEC06-T06S-R25E
AMC 432651	ROCKSTAR 314	2015-3897				SEC05-T06S-R25E
AMC 432652	ROCKSTAR 315	2015-3898				SEC05-T06S-R25E
AMC 432653	ROCKSTAR 316	2015-3899				SEC05-T06S-R25E
AMC 432654	ROCKSTAR 317	2015-3900				SEC05-T06S-R25E
AMC 432655	ROCKSTAR 318	2015-3901				SEC05-T06S-R25E
AMC 432656	ROCKSTAR 319	2015-3902				SEC05-T06S-R25E
AMC 432657	ROCKSTAR 320	2015-3903				SEC05-T06S-R25E
AMC 432658	ROCKSTAR 321	2015-3904				SEC05-T06S-R25E
AMC 432659	ROCKSTAR 322	2015-3905				SEC05-T06S-R25E
AMC 432660	ROCKSTAR 323	2015-3906				SEC05-T06S-R25E
AMC 432661	ROCKSTAR 324	2015-3907				SEC05-T06S-R25E
AMC 432662	ROCKSTAR 325	2015-3908				SEC05-T06S-R25E
AMC 432663	ROCKSTAR 326	2015-3909				SEC05-T06S-R25E
AMC 432664	ROCKSTAR 327	2015-3910				SEC05-T06S-R25E
AMC 432665	ROCKSTAR 328	2015-3911				SEC05-T06S-R25E
AMC 432666	ROCKSTAR 329	2015-3912				SEC05-T06S-R25E
AMC 432667	ROCKSTAR 330	2015-3913				SEC05-T06S-R25E
AMC 432668	ROCKSTAR 331	2015-3914				SEC05-T06S-R25E
AMC 432669	ROCKSTAR 332	2015-3915				SEC05-T06S-R25E
AMC 432670	ROCKSTAR 333	2015-3916				SEC05-T06S-R25E
AMC 432671	ROCKSTAR 334	2015-3917				SEC05-T06S-R25E
AMC 432672	ROCKSTAR 335	2015-3918				SEC05-T06S-R25E
AMC 432673	ROCKSTAR 336	2015-3919				SEC05-T06S-R25E
AMC 432674	ROCKSTAR 337	2015-3920				SEC05-T06S-R25E
AMC 432675	ROCKSTAR 338	2015-3921				SEC05-T06S-R25E
AMC 432676	ROCKSTAR 339	2015-3922				SEC05-T06S-R25E
AMC 432677	ROCKSTAR 340	2015-3923				SEC05-T06S-R25E
AMC 432678	ROCKSTAR 341	2015-3924				SEC05-T06S-R25E
AMC 432679	ROCKSTAR 342	2015-3925				SEC05-T06S-R25E
AMC 432680	ROCKSTAR 343	2015-3926				SEC05-T06S-R25E
AMC 432681	ROCKSTAR 344	2015-3927				SEC05-T06S-R25E

Date: 7/25/2016

RECEIVED  
 BLM AZ STATE OFFICE  
 2016 AUG - 3 A 9 27  
 PHOENIX, ARIZONA

EXHIBIT A

County: Graham

State: AZ

<u>BLM Serial #</u>	<u>Claim Name</u>	<u>Original Recording</u>		<u>Amended Recording</u>		<u>Location</u>
		<u>Recording #</u>	<u>Page #</u>	<u>Recording #</u>	<u>Page #</u>	
AMC 432682	ROCKSTAR 345	2015-3928				SEC05-T06S-R25E
AMC 432683	ROCKSTAR 346	2015-3929				SEC05-T06S-R25E
AMC 432684	ROCKSTAR 347	2015-3930				SEC05-T06S-R25E
AMC 432685	ROCKSTAR 348	2015-3931				SEC05-T06S-R25E
AMC 432686	ROCKSTAR 349	2015-3932				SEC05-T06S-R25E
AMC 432687	ROCKSTAR 350	2015-3933				SEC04-T06S-R25E
AMC 432688	ROCKSTAR 351	2015-3934				SEC04-T06S-R25E
AMC 432689	ROCKSTAR 352	2015-3935				SEC04-T06S-R25E
AMC 432690	ROCKSTAR 353	2015-3936				SEC04-T06S-R25E
AMC 432691	ROCKSTAR 354	2015-3937				SEC04-T06S-R25E
AMC 432692	ROCKSTAR 355	2015-3938				SEC04-T06S-R25E
AMC 432693	ROCKSTAR 356	2015-3939				SEC04-T06S-R25E
AMC 432694	ROCKSTAR 357	2015-3940				SEC04-T06S-R25E
AMC 432695	ROCKSTAR 358	2015-3941				SEC04-T06S-R25E
AMC 432696	ROCKSTAR 359	2015-3942				SEC04-T06S-R25E
AMC 432697	ROCKSTAR 360	2015-3943				SEC04-T06S-R25E
AMC 432698	ROCKSTAR 361	2015-3944				SEC04-T06S-R25E
AMC 432699	ROCKSTAR 362	2015-3945				SEC04-T06S-R25E
AMC 432700	ROCKSTAR 363	2015-3946				SEC04-T06S-R25E
AMC 432701	ROCKSTAR 364	2015-3947				SEC04-T06S-R25E
AMC 432702	ROCKSTAR 365	2015-3948				SEC04-T06S-R25E
AMC 432703	ROCKSTAR 366	2015-3949				SEC04-T06S-R25E
AMC 432704	ROCKSTAR 367	2015-3950				SEC04-T06S-R25E
AMC 432705	ROCKSTAR 368	2015-3951				SEC03-T06S-R25E
AMC 432706	ROCKSTAR 369	2015-3952				SEC03-T06S-R25E
AMC 432707	ROCKSTAR 370	2015-3953				SEC03-T06S-R25E
AMC 432708	ROCKSTAR 371	2015-3954				SEC03-T06S-R25E
AMC 432709	ROCKSTAR 372	2015-3955				SEC03-T06S-R25E
AMC 432710	ROCKSTAR 373	2015-3956				SEC03-T06S-R25E
AMC 432711	ROCKSTAR 374	2015-3957				SEC03-T06S-R25E
AMC 432712	ROCKSTAR 375	2015-3958				SEC03-T06S-R25E
AMC 432713	ROCKSTAR 376	2015-3959				SEC03-T06S-R25E
AMC 432714	ROCKSTAR 377	2015-3960				SEC03-T06S-R25E
AMC 432715	ROCKSTAR 378	2015-3961				SEC03-T06S-R25E
AMC 432716	ROCKSTAR 379	2015-3962				SEC03-T06S-R25E
AMC 432717	ROCKSTAR 380	2015-3963				SEC03-T06S-R25E
AMC 432718	ROCKSTAR 381	2015-3964				SEC03-T06S-R25E
AMC 432719	ROCKSTAR 382	2015-3965				SEC03-T06S-R25E

Date: 7/25/2016

PHOENIX, ARIZONA  
 2016 AUG - 3 A 9 27  
 RECEIVED  
 BLM AZ STATE OFFICE

## EXHIBIT A

County: Graham

State: AZ

<u>BLM Serial #</u>	<u>Claim Name</u>	<u>Original Recording</u>		<u>Amended Recording</u>		<u>Location</u>
		<u>Recording #</u>	<u>Page #</u>	<u>Recording #</u>	<u>Page #</u>	
AMC 432720	ROCKSTAR 383	2015-3966				SEC03-T06S-R25E
AMC 432721	ROCKSTAR 384	2015-3967				SEC03-T06S-R25E
AMC 432722	ROCKSTAR 385	2015-3968				SEC03-T06S-R25E
AMC 432723	ROCKSTAR 386	2015-3969				SEC03-T06S-R25E
AMC 432724	ROCKSTAR 387	2015-3970				SEC03-T06S-R25E
AMC 432725	ROCKSTAR 388	2015-3971				SEC03-T06S-R25E
AMC 432726	ROCKSTAR 389	2015-3972				SEC03-T06S-R25E
AMC 432727	ROCKSTAR 390	2015-3973				SEC03-T06S-R25E
AMC 432728	ROCKSTAR 391	2015-3974				SEC03-T06S-R25E
AMC 432729	ROCKSTAR 392	2015-3975				SEC03-T06S-R25E
AMC 432730	ROCKSTAR 393	2015-3976				SEC03-T06S-R25E
AMC 432731	ROCKSTAR 394	2015-3977				SEC03-T06S-R25E
AMC 432732	ROCKSTAR 395	2015-3978				SEC03-T06S-R25E
AMC 432733	ROCKSTAR 396	2015-3979				SEC03-T06S-R25E
AMC 432734	ROCKSTAR 397	2015-3980				SEC03-T06S-R25E
AMC 432735	ROCKSTAR 398	2015-3981				SEC03-T06S-R25E
AMC 432736	ROCKSTAR 399	2015-3982				SEC03-T06S-R25E
AMC 432737	ROCKSTAR 400	2015-3983				SEC03-T06S-R25E
AMC 432738	ROCKSTAR 401	2015-3984				SEC03-T06S-R25E
AMC 432739	ROCKSTAR 402	2015-3985				SEC03-T06S-R25E
AMC 432740	ROCKSTAR 403	2015-3986				SEC02-T06S-R25E
AMC 432741	ROCKSTAR 404	2015-3987				SEC02-T06S-R25E
AMC 432742	ROCKSTAR 405	2015-3988				SEC02-T06S-R25E
AMC 432743	ROCKSTAR 406	2015-3989				SEC02-T06S-R25E
AMC 432744	ROCKSTAR 407	2015-3990				SEC02-T06S-R25E
AMC 432745	ROCKSTAR 408	2015-3991				SEC02-T06S-R25E
AMC 432746	ROCKSTAR 409	2015-3992				SEC02-T06S-R25E
AMC 432747	ROCKSTAR 410	2015-3993				SEC02-T06S-R25E
AMC 432748	ROCKSTAR 411	2015-3994				SEC02-T06S-R25E
AMC 432749	ROCKSTAR 412	2015-3995				SEC02-T06S-R25E
AMC 432750	ROCKSTAR 413	2015-3996				SEC02-T06S-R25E
AMC 432751	ROCKSTAR 414	2015-3997				SEC02-T06S-R25E
AMC 432752	ROCKSTAR 415	2015-3998				SEC02-T06S-R25E
AMC 432753	ROCKSTAR 416	2015-3999				SEC02-T06S-R25E
AMC 432754	ROCKSTAR 417	2015-4000				SEC02-T06S-R25E
AMC 432755	ROCKSTAR 418	2015-4001				SEC02-T06S-R25E
AMC 432756	ROCKSTAR 419	2015-4002				SEC02-T06S-R25E
AMC 432757	ROCKSTAR 420	2015-4003				SEC02-T06S-R25E

Date: 7/25/2016

RECEIVED  
 BLM AZ STATE OFFICE  
 2016 AUG - 3 A 9: 21  
 PHOENIX, ARIZONA

## EXHIBIT A

County: Graham

State: AZ

<u>BLM Serial #</u>	<u>Claim Name</u>	<u>Original Recording</u>		<u>Amended Recording</u>		<u>Location</u>
		<u>Recording #</u>	<u>Page #</u>	<u>Recording #</u>	<u>Page #</u>	
AMC 432758	ROCKSTAR 421	2015-4004				SEC02-T06S-R25E
AMC 432759	ROCKSTAR 422	2015-4005				SEC02-T06S-R25E
AMC 432760	ROCKSTAR 423	2015-4006				SEC02-T06S-R25E
AMC 432761	ROCKSTAR 424	2015-4007				SEC02-T06S-R25E
AMC 432762	ROCKSTAR 425	2015-4008				SEC02-T06S-R25E
AMC 432763	ROCKSTAR 426	2015-4009				SEC02-T06S-R25E
AMC 432764	ROCKSTAR 427	2015-4010				SEC02-T06S-R25E
AMC 432765	ROCKSTAR 428	2015-4011				SEC02-T06S-R25E
AMC 432766	ROCKSTAR 429	2015-4012				SEC02-T06S-R25E
AMC 432767	ROCKSTAR 430	2015-4013				SEC02-T06S-R25E
AMC 432768	ROCKSTAR 431	2015-4014				SEC08-T06S-R25E
AMC 432769	ROCKSTAR 432	2015-4015				SEC08-T06S-R25E
AMC 432770	ROCKSTAR 433	2015-4016				SEC08-T06S-R25E
AMC 432771	ROCKSTAR 434	2015-4017				SEC08-T06S-R25E
AMC 432772	ROCKSTAR 435	2015-4018				SEC08-T06S-R25E
AMC 432773	ROCKSTAR 436	2015-4019				SEC08-T06S-R25E
AMC 432774	ROCKSTAR 437	2015-4020				SEC08-T06S-R25E
AMC 432775	ROCKSTAR 438	2015-4021				SEC08-T06S-R25E
AMC 432776	ROCKSTAR 439	2015-4022				SEC08-T06S-R25E
AMC 432777	ROCKSTAR 440	2015-4023				SEC08-T06S-R25E
AMC 432778	ROCKSTAR 441	2015-4024				SEC08-T06S-R25E
AMC 432779	ROCKSTAR 442	2015-4025				SEC08-T06S-R25E
AMC 432780	ROCKSTAR 443	2015-4026				SEC08-T06S-R25E
AMC 432781	ROCKSTAR 444	2015-4027				SEC08-T06S-R25E
AMC 432782	ROCKSTAR 445	2015-4028				SEC08-T06S-R25E
AMC 432783	ROCKSTAR 446	2015-4029				SEC08-T06S-R25E
AMC 432784	ROCKSTAR 447	2015-4030				SEC08-T06S-R25E
AMC 432785	ROCKSTAR 448	2015-4031				SEC08-T06S-R25E
AMC 432786	ROCKSTAR 449	2015-4032				SEC08-T06S-R25E
AMC 432787	ROCKSTAR 450	2015-4033				SEC08-T06S-R25E
AMC 432788	ROCKSTAR 451	2015-4034				SEC08-T06S-R25E
AMC 432789	ROCKSTAR 452	2015-4035				SEC08-T06S-R25E
AMC 432790	ROCKSTAR 453	2015-4036				SEC08-T06S-R25E
AMC 432791	ROCKSTAR 454	2015-4037				SEC09-T06S-R25E
AMC 432792	ROCKSTAR 455	2015-4038				SEC09-T06S-R25E
AMC 432793	ROCKSTAR 456	2015-4039				SEC09-T06S-R25E
AMC 432794	ROCKSTAR 457	2015-4040				SEC09-T06S-R25E
AMC 432795	ROCKSTAR 458	2015-4041				SEC09-T06S-R25E

Date: 7/25/2016

RECEIVED  
BLM AZ STATE OFFICE

PHOENIX, ARIZONA  
2016 AUG - 3 A 9 27

## EXHIBIT A

County: Graham

State: AZ

<u>BLM Serial #</u>	<u>Claim Name</u>	<u>Original Recording</u>		<u>Amended Recording</u>		<u>Location</u>
		<u>Recording #</u>	<u>Page #</u>	<u>Recording #</u>	<u>Page #</u>	
AMC 432796	ROCKSTAR 459	2015-4042				SEC09-T06S-R25E
AMC 432797	ROCKSTAR 460	2015-4043				SEC09-T06S-R25E
AMC 432798	ROCKSTAR 461	2015-4044				SEC09-T06S-R25E
AMC 432799	ROCKSTAR 462	2015-4045				SEC09-T06S-R25E
AMC 432800	ROCKSTAR 463	2015-4046				SEC09-T06S-R25E
AMC 432801	ROCKSTAR 464	2015-4047				SEC09-T06S-R25E
AMC 432802	ROCKSTAR 465	2015-4048				SEC09-T06S-R25E
AMC 432803	ROCKSTAR 466	2015-4049				SEC09-T06S-R25E
AMC 432804	ROCKSTAR 467	2015-4050				SEC09-T06S-R25E
AMC 432805	ROCKSTAR 468	2015-4051				SEC09-T06S-R25E
AMC 432806	ROCKSTAR 469	2015-4052				SEC09-T06S-R25E
AMC 432807	ROCKSTAR 470	2015-4053				SEC09-T06S-R25E
AMC 432808	ROCKSTAR 471	2015-4054				SEC09-T06S-R25E
AMC 432809	ROCKSTAR 472	2015-4055				SEC10-T06S-R25E
AMC 432810	ROCKSTAR 473	2015-4056				SEC10-T06S-R25E
AMC 432811	ROCKSTAR 474	2015-4057				SEC10-T06S-R25E
AMC 432812	ROCKSTAR 475	2015-4058				SEC10-T06S-R25E
AMC 432813	ROCKSTAR 476	2015-4059				SEC10-T06S-R25E
AMC 432814	ROCKSTAR 477	2015-4060				SEC10-T06S-R25E
AMC 432815	ROCKSTAR 478	2015-4061				SEC10-T06S-R25E
AMC 432816	ROCKSTAR 479	2015-4062				SEC10-T06S-R25E
AMC 432817	ROCKSTAR 480	2015-4063				SEC10-T06S-R25E
AMC 432818	ROCKSTAR 481	2015-4064				SEC10-T06S-R25E
AMC 432819	ROCKSTAR 482	2015-4065				SEC10-T06S-R25E
AMC 432820	ROCKSTAR 483	2015-4066				SEC10-T06S-R25E
AMC 432821	ROCKSTAR 484	2015-4067				SEC10-T06S-R25E
AMC 432822	ROCKSTAR 485	2015-4068				SEC10-T06S-R25E
AMC 432823	ROCKSTAR 486	2015-4069				SEC10-T06S-R25E
AMC 432824	ROCKSTAR 487	2015-4070				SEC10-T06S-R25E
AMC 432825	ROCKSTAR 488	2015-4071				SEC10-T06S-R25E
AMC 432826	ROCKSTAR 489	2015-4072				SEC10-T06S-R25E
AMC 432827	ROCKSTAR 490	2015-4073				SEC10-T06S-R25E
AMC 432828	ROCKSTAR 491	2015-4074				SEC10-T06S-R25E
AMC 432829	ROCKSTAR 492	2015-4075				SEC10-T06S-R25E
AMC 432830	ROCKSTAR 493	2015-4076				SEC10-T06S-R25E
AMC 432831	ROCKSTAR 494	2015-4077				SEC10-T06S-R25E
AMC 432832	ROCKSTAR 495	2015-4078				SEC10-T06S-R25E
AMC 432833	ROCKSTAR 496	2015-4079				SEC10-T06S-R25E

Date: 7/25/2016

RECEIVED  
BLM AZ STATE OFFICE  
2016 AUG - 3 A 9 21  
PHOENIX, ARIZONA

## EXHIBIT A

County: Graham

State: AZ

<u>BLM Serial #</u>	<u>Claim Name</u>	<u>Original Recording</u>		<u>Amended Recording</u>		<u>Location</u>
		<u>Recording #</u>	<u>Page #</u>	<u>Recording #</u>	<u>Page #</u>	
AMC 432834	ROCKSTAR 497	2015-4080				SEC10-T06S-R25E
AMC 432835	ROCKSTAR 498	2015-4081				SEC10-T06S-R25E
AMC 432836	ROCKSTAR 499	2015-4082				SEC10-T06S-R25E
AMC 432837	ROCKSTAR 500	2015-4083				SEC10-T06S-R25E
AMC 432838	ROCKSTAR 501	2015-4084				SEC10-T06S-R25E
AMC 432839	ROCKSTAR 502	2015-4085				SEC10-T06S-R25E
AMC 432840	ROCKSTAR 503	2015-4086				SEC10-T06S-R25E
AMC 432841	ROCKSTAR 504	2015-4087				SEC10-T06S-R25E
AMC 432842	ROCKSTAR 505	2015-4088				SEC10-T06S-R25E
AMC 432843	ROCKSTAR 506	2015-4089				SEC10-T06S-R25E
AMC 432844	ROCKSTAR 507	2015-4090				SEC11-T06S-R25E
AMC 432845	ROCKSTAR 508	2015-4091				SEC11-T06S-R25E
AMC 432846	ROCKSTAR 509	2015-4092				SEC11-T06S-R25E
AMC 432847	ROCKSTAR 510	2015-4093				SEC11-T06S-R25E
AMC 432848	ROCKSTAR 511	2015-4094				SEC11-T06S-R25E
AMC 432849	ROCKSTAR 512	2015-4095				SEC11-T06S-R25E
AMC 432850	ROCKSTAR 513	2015-4096				SEC11-T06S-R25E
AMC 432851	ROCKSTAR 514	2015-4097				SEC11-T06S-R25E
AMC 432852	ROCKSTAR 515	2015-4098				SEC11-T06S-R25E
AMC 432853	ROCKSTAR 516	2015-4099				SEC11-T06S-R25E
AMC 432854	ROCKSTAR 517	2015-4100				SEC11-T06S-R25E
AMC 432855	ROCKSTAR 518	2015-4101				SEC11-T06S-R25E
AMC 432856	ROCKSTAR 519	2015-4102				SEC11-T06S-R25E
AMC 432857	ROCKSTAR 520	2015-4103				SEC11-T06S-R25E
AMC 432858	ROCKSTAR 521	2015-4104				SEC11-T06S-R25E
AMC 432859	ROCKSTAR 522	2015-4105				SEC11-T06S-R25E
AMC 432860	ROCKSTAR 523	2015-4106				SEC11-T06S-R25E
AMC 432861	ROCKSTAR 524	2015-4107				SEC11-T06S-R25E
AMC 432862	ROCKSTAR 525	2015-4108				SEC11-T06S-R25E
AMC 432863	ROCKSTAR 526	2015-4109				SEC11-T06S-R25E
AMC 432864	ROCKSTAR 527	2015-4110				SEC11-T06S-R25E
AMC 432865	ROCKSTAR 528	2015-4111				SEC11-T06S-R25E
AMC 432866	ROCKSTAR 529	2015-4112				SEC11-T06S-R25E
AMC 432867	ROCKSTAR 530	2015-4113				SEC11-T06S-R25E
AMC 432868	ROCKSTAR 531	2015-4114				SEC11-T06S-R25E
AMC 432869	ROCKSTAR 532	2015-4115				SEC11-T06S-R25E
AMC 432870	ROCKSTAR 533	2015-4116				SEC11-T06S-R25E
AMC 432871	ROCKSTAR 534	2015-4117				SEC15-T06S-R25E

Date: 7/25/2016

RECEIVED  
BLM AZ STATE OFFICE  
2016 AUG - 3 A 9 27  
PHOENIX, ARIZONA

## EXHIBIT A

County: Graham

State: AZ

BLM Serial #	Claim Name	Original Recording		Amended Recording		Location
		Recording #	Page #	Recording #	Page #	
AMC 432872	ROCKSTAR 535	2015-4118				SEC15-T06S-R25E
AMC 432873	ROCKSTAR 536	2015-4119				SEC15-T06S-R25E
AMC 432874	ROCKSTAR 537	2015-4120				SEC15-T06S-R25E
AMC 432875	ROCKSTAR 538	2015-4121				SEC15-T06S-R25E
AMC 432876	ROCKSTAR 539	2015-4122				SEC15-T06S-R25E
AMC 432877	ROCKSTAR 540	2015-4123				SEC15-T06S-R25E
AMC 432878	ROCKSTAR 541	2015-4124				SEC15-T06S-R25E
AMC 432879	ROCKSTAR 542	2015-4125				SEC15-T06S-R25E
AMC 432880	ROCKSTAR 543	2015-4126				SEC15-T06S-R25E
AMC 432881	ROCKSTAR 544	2015-4127				SEC15-T06S-R25E
AMC 432882	ROCKSTAR 545	2015-4128				SEC15-T06S-R25E
AMC 432883	ROCKSTAR 546	2015-4129				SEC15-T06S-R25E
AMC 432884	ROCKSTAR 547	2015-4130				SEC15-T06S-R25E
AMC 432885	ROCKSTAR 548	2015-4131				SEC15-T06S-R25E
AMC 432886	ROCKSTAR 549	2015-4132				SEC15-T06S-R25E
AMC 432887	ROCKSTAR 550	2015-4133				SEC15-T06S-R25E
AMC 432888	ROCKSTAR 551	2015-4134				SEC15-T06S-R25E
AMC 432889	ROCKSTAR 552	2015-4135				SEC15-T06S-R25E
AMC 432890	ROCKSTAR 553	2015-4136				SEC15-T06S-R25E
AMC 432891	ROCKSTAR 554	2015-4137				SEC15-T06S-R25E
AMC 432892	ROCKSTAR 555	2015-4138				SEC15-T06S-R25E
AMC 432893	ROCKSTAR 556	2015-4139				SEC15-T06S-R25E
AMC 432894	ROCKSTAR 557	2015-4140				SEC15-T06S-R25E
AMC 432895	ROCKSTAR 558	2015-4141				SEC15-T06S-R25E
AMC 432896	ROCKSTAR 559	2015-4142				SEC15-T06S-R25E
AMC 432897	ROCKSTAR 560	2015-4143				SEC15-T06S-R25E
AMC 432898	ROCKSTAR 561	2015-4144				SEC15-T06S-R25E
AMC 432899	ROCKSTAR 562	2015-4145				SEC15-T06S-R25E
AMC 432900	ROCKSTAR 563	2015-4146				SEC15-T06S-R25E
AMC 432901	ROCKSTAR 564	2015-4147				SEC14-T06S-R25E
AMC 432902	ROCKSTAR 565	2015-4148				SEC14-T06S-R25E
AMC 432903	ROCKSTAR 566	2015-4149				SEC14-T06S-R25E
AMC 432904	ROCKSTAR 567	2015-4150				SEC14-T06S-R25E
AMC 432905	ROCKSTAR 568	2015-4151				SEC14-T06S-R25E
AMC 432906	ROCKSTAR 569	2015-4152				SEC14-T06S-R25E
AMC 432907	ROCKSTAR 570	2015-4153				SEC14-T06S-R25E
AMC 432908	ROCKSTAR 571	2015-4154				SEC14-T06S-R25E
AMC 432909	ROCKSTAR 572	2015-4155				SEC14-T06S-R25E

Date: 7/25/2016

RECEIVED  
 BLM AZ STATE OFFICE  
 2016 AUG - 3 A 9: 27  
 PHOENIX, ARIZONA

# EXHIBIT A

County: Graham

State: AZ

<u>BLM Serial #</u>	<u>Claim Name</u>	<u>Original Recording</u>		<u>Amended Recording</u>		<u>Location</u>
		<u>Recording #</u>	<u>Page #</u>	<u>Recording #</u>	<u>Page #</u>	
AMC 432910	ROCKSTAR 573	2015-4156				SEC14-T06S-R25E
AMC 432911	ROCKSTAR 574	2015-4157				SEC14-T06S-R25E
AMC 432912	ROCKSTAR 575	2015-4158				SEC14-T06S-R25E
AMC 432913	ROCKSTAR 576	2015-4159				SEC14-T06S-R25E
AMC 432914	ROCKSTAR 577	2015-4160				SEC14-T06S-R25E
AMC 432915	ROCKSTAR 578	2015-4161				SEC14-T06S-R25E
AMC 432916	ROCKSTAR 579	2015-4162				SEC14-T06S-R25E
AMC 432917	ROCKSTAR 580	2015-4163				SEC14-T06S-R25E
AMC 432918	ROCKSTAR 581	2015-4164				SEC14-T06S-R25E
AMC 432919	ROCKSTAR 582	2015-4165				SEC14-T06S-R25E
AMC 432920	ROCKSTAR 583	2015-4166				SEC14-T06S-R25E
AMC 432921	ROCKSTAR 584	2015-4167				SEC14-T06S-R25E
AMC 432922	ROCKSTAR 585	2015-4168				SEC14-T06S-R25E
AMC 432923	ROCKSTAR 586	2015-4169				SEC14-T06S-R25E
AMC 432924	ROCKSTAR 587	2015-4170				SEC14-T06S-R25E
AMC 432925	ROCKSTAR 588	2015-4171				SEC14-T06S-R25E
AMC 432926	ROCKSTAR 589	2015-4172				SEC14-T06S-R25E
AMC 432927	ROCKSTAR 590	2015-4173				SEC14-T06S-R25E
AMC 432928	ROCKSTAR 591	2015-4174				SEC14-T06S-R25E
AMC 432929	ROCKSTAR 592	2015-4175				SEC14-T06S-R25E
AMC 432930	ROCKSTAR 593	2015-4176				SEC14-T06S-R25E
AMC 432931	ROCKSTAR 594	2015-4177				SEC14-T06S-R25E
AMC 432994	ROCKSTAR 595	2015-4259				SEC13-T06S-R25E
AMC 432995	ROCKSTAR 596	2015-4260				SEC13-T06S-R25E
AMC 432996	ROCKSTAR 597	2015-4261				SEC13-T06S-R25E
AMC 432997	ROCKSTAR 598	2015-4262				SEC13-T06S-R25E
AMC 432998	ROCKSTAR 599	2015-4263				SEC13-T06S-R25E
AMC 432999	ROCKSTAR 600	2015-4264				SEC13-T06S-R25E
AMC 433000	ROCKSTAR 601	2015-4265				SEC13-T06S-R25E
AMC 433001	ROCKSTAR 602	2015-4266				SEC13-T06S-R25E
AMC 433002	ROCKSTAR 603	2015-4267				SEC13-T06S-R25E
AMC 433003	ROCKSTAR 604	2015-4268				SEC13-T06S-R25E
AMC 433004	ROCKSTAR 605	2015-4269				SEC13-T06S-R25E
AMC 433005	ROCKSTAR 606	2015-4270				SEC13-T06S-R25E
AMC 433006	ROCKSTAR 607	2015-4271				SEC13-T06S-R25E
AMC 433007	ROCKSTAR 608	2015-4272				SEC13-T06S-R25E
AMC 433008	ROCKSTAR 609	2015-4273				SEC13-T06S-R25E
AMC 433009	ROCKSTAR 610	2015-4274				SEC13-T06S-R25E

Date: 7/25/2016

PHOENIX, ARIZONA  
2016 AUG - 3 A 9 27  
RECEIVED  
BLM AZ STATE OFFICE



## EXHIBIT A

County: Graham

State: AZ

<u>BLM Serial #</u>	<u>Claim Name</u>	<u>Original Recording</u>		<u>Amended Recording</u>		<u>Location</u>
		<u>Recording #</u>	<u>Page #</u>	<u>Recording #</u>	<u>Page #</u>	
AMC 433010	ROCKSTAR 611	2015-4275				SEC13-T06S-R25E
AMC 433011	ROCKSTAR 612	2015-4276				SEC13-T06S-R25E
AMC 433012	ROCKSTAR 613	2015-4277				SEC13-T06S-R25E
AMC 433013	ROCKSTAR 614	2015-4278				SEC13-T06S-R25E
AMC 433014	ROCKSTAR 615	2015-4279				SEC23-T06S-R25E
AMC 433015	ROCKSTAR 616	2015-4280				SEC23-T06S-R25E
AMC 433016	ROCKSTAR 617	2015-4281				SEC23-T06S-R25E
AMC 433017	ROCKSTAR 618	2015-4282				SEC23-T06S-R25E
AMC 433018	ROCKSTAR 619	2015-4283				SEC23-T06S-R25E
AMC 433019	ROCKSTAR 620	2015-4284				SEC23-T06S-R25E
AMC 433020	ROCKSTAR 621	2015-4285				SEC23-T06S-R25E
AMC 433021	ROCKSTAR 622	2015-4286				SEC23-T06S-R25E
AMC 433022	ROCKSTAR 623	2015-4287				SEC23-T06S-R25E
AMC 433023	ROCKSTAR 624	2015-4288				SEC23-T06S-R25E
AMC 433024	ROCKSTAR 625	2015-4289				SEC23-T06S-R25E
AMC 433025	ROCKSTAR 626	2015-4290				SEC23-T06S-R25E
AMC 433026	ROCKSTAR 627	2015-4291				SEC23-T06S-R25E
AMC 433027	ROCKSTAR 628	2015-4292				SEC23-T06S-R25E
AMC 433028	ROCKSTAR 629	2015-4293				SEC23-T06S-R25E
AMC 433029	ROCKSTAR 630	2015-4294				SEC23-T06S-R25E
AMC 433030	ROCKSTAR 631	2015-4295				SEC23-T06S-R25E
AMC 433031	ROCKSTAR 632	2015-4296				SEC23-T06S-R25E
AMC 433032	ROCKSTAR 633	2015-4297				SEC23-T06S-R25E
AMC 433033	ROCKSTAR 634	2015-4298				SEC23-T06S-R25E
AMC 433034	ROCKSTAR 635	2015-4299				SEC23-T06S-R25E
AMC 433035	ROCKSTAR 636	2015-4300				SEC23-T06S-R25E
AMC 433036	ROCKSTAR 637	2015-4301				SEC23-T06S-R25E
AMC 433037	ROCKSTAR 638	2015-4302				SEC23-T06S-R25E
AMC 433038	ROCKSTAR 639	2015-4303				SEC23-T06S-R25E
AMC 433039	ROCKSTAR 640	2015-4304				SEC23-T06S-R25E
AMC 433040	ROCKSTAR 641	2015-4305				SEC23-T06S-R25E
AMC 433041	ROCKSTAR 642	2015-4306				SEC23-T06S-R25E
AMC 433042	ROCKSTAR 643	2015-4307				SEC23-T06S-R25E
AMC 433043	ROCKSTAR 644	2015-4308				SEC23-T06S-R25E
AMC 433044	ROCKSTAR 645	2015-4309				SEC23-T06S-R25E
AMC 433045	ROCKSTAR 646	2015-4310				SEC23-T06S-R25E
AMC 433046	ROCKSTAR 647	2015-4311				SEC24-T06S-R25E
AMC 433047	ROCKSTAR 648	2015-4312				SEC24-T06S-R25E

Date: 7/25/2016

Page 84

RECEIVED  
 BLM AZ STATE OFFICE  
 2016 AUG - 3 A 9 27  
 PHOENIX, ARIZONA

## EXHIBIT A

County: Graham

State: AZ

<u>BLM Serial #</u>	<u>Claim Name</u>	<u>Original Recording</u>		<u>Amended Recording</u>		<u>Location</u>
		<u>Recording #</u>	<u>Page #</u>	<u>Recording #</u>	<u>Page #</u>	
AMC 433048	ROCKSTAR 649	2015-4313				SEC24-T06S-R25E
AMC 433049	ROCKSTAR 650	2015-4314				SEC24-T06S-R25E
AMC 433050	ROCKSTAR 651	2015-4315				SEC24-T06S-R25E
AMC 433051	ROCKSTAR 652	2015-4316				SEC24-T06S-R25E
AMC 433052	ROCKSTAR 653	2015-4317				SEC24-T06S-R25E
AMC 433053	ROCKSTAR 654	2015-4318				SEC24-T06S-R25E
AMC 433054	ROCKSTAR 655	2015-4319				SEC24-T06S-R25E
AMC 433055	ROCKSTAR 656	2015-4320				SEC24-T06S-R25E
AMC 433056	ROCKSTAR 657	2015-4321				SEC24-T06S-R25E
AMC 433057	ROCKSTAR 658	2015-4322				SEC24-T06S-R25E
AMC 433058	ROCKSTAR 659	2015-4323				SEC24-T06S-R25E
AMC 433059	ROCKSTAR 660	2015-4324				SEC24-T06S-R25E
AMC 433060	ROCKSTAR 661	2015-4325				SEC24-T06S-R25E
AMC 433061	ROCKSTAR 662	2015-4326				SEC24-T06S-R25E
AMC 433062	ROCKSTAR 663	2015-4327				SEC24-T06S-R25E
AMC 433063	ROCKSTAR 664	2015-4328				SEC24-T06S-R25E
AMC 433064	ROCKSTAR 665	2015-4329				SEC24-T06S-R25E
AMC 433065	ROCKSTAR 666	2015-4330				SEC24-T06S-R25E
AMC 433066	ROCKSTAR 667	2015-4331				SEC24-T06S-R25E
AMC 433067	ROCKSTAR 668	2015-4332				SEC24-T06S-R25E
AMC 433068	ROCKSTAR 669	2015-4333				SEC24-T06S-R25E
AMC 433069	ROCKSTAR 670	2015-4334				SEC24-T06S-R25E
AMC 433070	ROCKSTAR 671	2015-4335				SEC24-T06S-R25E
AMC 433071	ROCKSTAR 672	2015-4336				SEC24-T06S-R25E
AMC 433072	ROCKSTAR 673	2015-4337				SEC24-T06S-R25E
AMC 433073	ROCKSTAR 674	2015-4338				SEC24-T06S-R25E
AMC 433074	ROCKSTAR 675	2015-4339				SEC24-T06S-R25E
AMC 433075	ROCKSTAR 676	2015-4340				SEC24-T06S-R25E
AMC 433076	ROCKSTAR 677	2015-4341				SEC24-T06S-R25E
AMC 433077	ROCKSTAR 678	2015-4342				SEC24-T06S-R25E
AMC 433078	ROCKSTAR 679	2015-4343				SEC24-T06S-R25E
AMC 433079	ROCKSTAR 680	2015-4344				SEC24-T06S-R25E
AMC 433080	ROCKSTAR 681	2015-4345				SEC24-T06S-R25E
AMC 433081	ROCKSTAR 682	2015-4346				SEC24-T06S-R25E
AMC 433082	ROCKSTAR 683	2015-4347				SEC25-T06S-R25E
AMC 433083	ROCKSTAR 684	2015-4348				SEC25-T06S-R25E
AMC 433084	ROCKSTAR 685	2015-4349				SEC25-T06S-R25E
AMC 433085	ROCKSTAR 686	2015-4350				SEC25-T06S-R25E

Date: 7/25/2016

RECEIVED  
BLM AZ STATE OFFICE  
2016 AUG - 3 A 9: 27  
PHOENIX, ARIZONA

## EXHIBIT A

County: Graham

State: AZ

<u>BLM Serial #</u>	<u>Claim Name</u>	<u>Original Recording</u>		<u>Amended Recording</u>		<u>Location</u>
		<u>Recording #</u>	<u>Page #</u>	<u>Recording #</u>	<u>Page #</u>	
AMC 433086	ROCKSTAR 687	2015-4351				SEC25-T06S-R25E
AMC 433087	ROCKSTAR 688	2015-4352				SEC25-T06S-R25E
AMC 433088	ROCKSTAR 689	2015-4353				SEC25-T06S-R25E
AMC 433089	ROCKSTAR 690	2015-4354				SEC25-T06S-R25E
AMC 433090	ROCKSTAR 691	2015-4355				SEC25-T06S-R25E
AMC 433091	ROCKSTAR 692	2015-4356				SEC25-T06S-R25E
AMC 433092	ROCKSTAR 693	2015-4357				SEC25-T06S-R25E
AMC 433093	ROCKSTAR 694	2015-4358				SEC25-T06S-R25E
AMC 433094	ROCKSTAR 695	2015-4359				SEC25-T06S-R25E
AMC 433095	ROCKSTAR 696	2015-4360				SEC25-T06S-R25E
AMC 433096	ROCKSTAR 697	2015-4361				SEC25-T06S-R25E
AMC 433097	ROCKSTAR 698	2015-4362				SEC25-T06S-R25E
AMC 433098	ROCKSTAR 699	2015-4363				SEC25-T06S-R25E
AMC 433099	ROCKSTAR 700	2015-4364				SEC25-T06S-R25E
AMC 433100	ROCKSTAR 701	2015-4365				SEC25-T06S-R25E
AMC 433101	ROCKSTAR 702	2015-4366				SEC25-T06S-R25E
AMC 433102	ROCKSTAR 703	2015-4367				SEC25-T06S-R25E
AMC 433103	ROCKSTAR 704	2015-4368				SEC25-T06S-R25E
AMC 433104	ROCKSTAR 705	2015-4369				SEC25-T06S-R25E
AMC 433105	ROCKSTAR 706	2015-4370				SEC25-T06S-R25E
AMC 433106	ROCKSTAR 707	2015-4371				SEC25-T06S-R25E
AMC 433107	ROCKSTAR 708	2015-4372				SEC25-T06S-R25E
AMC 433108	ROCKSTAR 709	2015-4373				SEC25-T06S-R25E
AMC 433109	ROCKSTAR 710	2015-4374				SEC18-T06S-R26E
AMC 433110	ROCKSTAR 711	2015-4375				SEC18-T06S-R26E
AMC 433111	ROCKSTAR 712	2015-4376				SEC18-T06S-R26E
AMC 433112	ROCKSTAR 713	2015-4377				SEC18-T06S-R26E
AMC 433113	ROCKSTAR 714	2015-4378				SEC18-T06S-R26E
AMC 433114	ROCKSTAR 715	2015-4379				SEC18-T06S-R26E
AMC 433115	ROCKSTAR 716	2015-4380				SEC18-T06S-R26E
AMC 433116	ROCKSTAR 717	2015-4381				SEC18-T06S-R26E
AMC 433117	ROCKSTAR 718	2015-4382				SEC18-T06S-R26E
AMC 433118	ROCKSTAR 719	2015-4383				SEC18-T06S-R26E
AMC 433119	ROCKSTAR 720	2015-4384				SEC18-T06S-R26E
AMC 433120	ROCKSTAR 721	2015-4385				SEC18-T06S-R26E
AMC 433121	ROCKSTAR 722	2015-4386				SEC18-T06S-R26E
AMC 433122	ROCKSTAR 723	2015-4387				SEC18-T06S-R26E
AMC 433123	ROCKSTAR 724	2015-4388				SEC18-T06S-R26E

Date: 7/25/2016

Page 86

RECEIVED  
BLM AZ STATE OFFICE  
2016 AUG - 3 A 9 23  
HOENIX, ARIZONA

## EXHIBIT A

County: Graham

State: AZ

<u>BLM Serial #</u>	<u>Claim Name</u>	<u>Original Recording</u>		<u>Amended Recording</u>		<u>Location</u>
		<u>Recording #</u>	<u>Page #</u>	<u>Recording #</u>	<u>Page #</u>	
AMC 433124	ROCKSTAR 725	2015-4389				SEC18-T06S-R26E
AMC 433125	ROCKSTAR 726	2015-4390				SEC18-T06S-R26E
AMC 433126	ROCKSTAR 727	2015-4391				SEC19-T06S-R26E
AMC 433127	ROCKSTAR 728	2015-4392				SEC19-T06S-R26E
AMC 433128	ROCKSTAR 729	2015-4393				SEC19-T06S-R26E
AMC 433129	ROCKSTAR 730	2015-4394				SEC19-T06S-R26E
AMC 433130	ROCKSTAR 731	2015-4395				SEC19-T06S-R26E
AMC 433131	ROCKSTAR 732	2015-4396				SEC19-T06S-R26E
AMC 433132	ROCKSTAR 733	2015-4397				SEC19-T06S-R26E
AMC 433133	ROCKSTAR 734	2015-4398				SEC19-T06S-R26E
AMC 433134	ROCKSTAR 735	2015-4399				SEC19-T06S-R26E
AMC 433135	ROCKSTAR 736	2015-4400				SEC19-T06S-R26E
AMC 433136	ROCKSTAR 737	2015-4401				SEC19-T06S-R26E
AMC 433137	ROCKSTAR 738	2015-4402				SEC19-T06S-R26E
AMC 433138	ROCKSTAR 739	2015-4403				SEC19-T06S-R26E
AMC 433139	ROCKSTAR 740	2015-4404				SEC19-T06S-R26E
AMC 433140	ROCKSTAR 741	2015-4405				SEC19-T06S-R26E
AMC 433141	ROCKSTAR 742	2015-4406				SEC19-T06S-R26E
AMC 433142	ROCKSTAR 743	2015-4407				SEC19-T06S-R26E
AMC 433143	ROCKSTAR 744	2015-4408				SEC19-T06S-R26E
AMC 433144	ROCKSTAR 745	2015-4409				SEC19-T06S-R26E
AMC 433145	ROCKSTAR 746	2015-4410				SEC19-T06S-R26E
AMC 433146	ROCKSTAR 747	2015-4411				SEC19-T06S-R26E
AMC 433147	ROCKSTAR 748	2015-4412				SEC19-T06S-R26E
AMC 433148	ROCKSTAR 749	2015-4413				SEC19-T06S-R26E
AMC 433149	ROCKSTAR 750	2015-4414				SEC19-T06S-R26E
AMC 433150	ROCKSTAR 751	2015-4415				SEC19-T06S-R26E
AMC 433151	ROCKSTAR 752	2015-4416				SEC19-T06S-R26E
AMC 433152	ROCKSTAR 753	2015-4417				SEC19-T06S-R26E
AMC 433153	ROCKSTAR 754	2015-4418				SEC20-T06S-R26E
AMC 433154	ROCKSTAR 755	2015-4419				SEC20-T06S-R26E
AMC 433155	ROCKSTAR 756	2015-4420				SEC20-T06S-R26E
AMC 433156	ROCKSTAR 757	2015-4421				SEC20-T06S-R26E
AMC 433157	ROCKSTAR 758	2015-4422				SEC20-T06S-R26E
AMC 433158	ROCKSTAR 759	2015-4423				SEC20-T06S-R26E
AMC 433159	ROCKSTAR 760	2015-4424				SEC20-T06S-R26E
AMC 433160	ROCKSTAR 761	2015-4425				SEC20-T06S-R26E
AMC 433161	ROCKSTAR 762	2015-4426				SEC20-T06S-R26E

Date: 7/25/2016

RECEIVED  
 BLM AZ STATE OFFICE  
 2016 AUG - 3 A 9 27  
 PHOENIX, ARIZONA

## EXHIBIT A

County: Graham

State: AZ

BLM Serial #	Claim Name	Original Recording		Amended Recording		Location
		Recording #	Page #	Recording #	Page #	
AMC 433162	ROCKSTAR 763	2015-4427				SEC20-T06S-R26E
AMC 433163	ROCKSTAR 764	2015-4428				SEC20-T06S-R26E
AMC 433164	ROCKSTAR 765	2015-4429				SEC20-T06S-R26E
AMC 433165	ROCKSTAR 766	2015-4430				SEC20-T06S-R26E
AMC 433166	ROCKSTAR 767	2015-4431				SEC20-T06S-R26E
AMC 433167	ROCKSTAR 768	2015-4432				SEC20-T06S-R26E
AMC 433168	ROCKSTAR 769	2015-4433				SEC20-T06S-R26E
AMC 433169	ROCKSTAR 770	2015-4434				SEC20-T06S-R26E
AMC 433170	ROCKSTAR 771	2015-4435				SEC20-T06S-R26E
AMC 433171	ROCKSTAR 772	2015-4436				SEC20-T06S-R26E
AMC 433172	ROCKSTAR 773	2015-4437				SEC20-T06S-R26E
AMC 433173	ROCKSTAR 774	2015-4438				SEC20-T06S-R26E
AMC 433174	ROCKSTAR 775	2015-4439				SEC20-T06S-R26E
AMC 433175	ROCKSTAR 776	2015-4440				SEC20-T06S-R26E
AMC 433176	ROCKSTAR 777	2015-4441				SEC20-T06S-R26E
AMC 433177	ROCKSTAR 778	2015-4442				SEC20-T06S-R26E
AMC 433178	ROCKSTAR 779	2015-4443				SEC20-T06S-R26E
AMC 433179	ROCKSTAR 780	2015-4444				SEC20-T06S-R26E
AMC 433180	ROCKSTAR 781	2015-4445				SEC20-T06S-R26E
AMC 433181	ROCKSTAR 782	2015-4446				SEC20-T06S-R26E
AMC 433182	ROCKSTAR 783	2015-4447				SEC20-T06S-R26E
AMC 433183	ROCKSTAR 784	2015-4448				SEC20-T06S-R26E
AMC 433184	ROCKSTAR 785	2015-4449				SEC20-T06S-R26E
AMC 433185	ROCKSTAR 786	2015-4450				SEC20-T06S-R26E
AMC 433186	ROCKSTAR 787	2015-4451				SEC20-T06S-R26E
AMC 433187	ROCKSTAR 788	2015-4452				SEC20-T06S-R26E
AMC 433188	ROCKSTAR 789	2015-4453				SEC20-T06S-R26E
AMC 433189	ROCKSTAR 790	2015-4454				SEC21-T06S-R26E
AMC 433190	ROCKSTAR 791	2015-4455				SEC21-T06S-R26E
AMC 433191	ROCKSTAR 792	2015-4456				SEC21-T06S-R26E
AMC 433192	ROCKSTAR 793	2015-4457				SEC21-T06S-R26E
AMC 433193	ROCKSTAR 794	2015-4458				SEC21-T06S-R26E
AMC 433194	ROCKSTAR 795	2015-4459				SEC21-T06S-R26E
AMC 433195	ROCKSTAR 796	2015-4460				SEC21-T06S-R26E
AMC 433196	ROCKSTAR 797	2015-4461				SEC21-T06S-R26E
AMC 433197	ROCKSTAR 798	2015-4462				SEC21-T06S-R26E
AMC 433198	ROCKSTAR 799	2015-4463				SEC21-T06S-R26E
AMC 433199	ROCKSTAR 800	2015-4464				SEC21-T06S-R26E

Date: 7/25/2016

Page 88

RECEIVED  
 BLM AZ STATE OFFICE  
 2016 AUG - 3 A 9 27  
 PHOENIX, ARIZONA

## EXHIBIT A

County: Graham

State: AZ

BLM Serial #	Claim Name	Original Recording		Amended Recording		Location
		Recording #	Page #	Recording #	Page #	
AMC 433200	ROCKSTAR 801	2015-4465				SEC21-T06S-R26E
AMC 433201	ROCKSTAR 802	2015-4466				SEC21-T06S-R26E
AMC 433202	ROCKSTAR 803	2015-4467				SEC21-T06S-R26E
AMC 433203	ROCKSTAR 804	2015-4468				SEC21-T06S-R26E
AMC 433204	ROCKSTAR 805	2015-4469				SEC21-T06S-R26E
AMC 433205	ROCKSTAR 806	2015-4470				SEC21-T06S-R26E
AMC 433206	ROCKSTAR 807	2015-4471				SEC21-T06S-R26E
AMC 433207	ROCKSTAR 808	2015-4472				SEC21-T06S-R26E
AMC 433208	ROCKSTAR 809	2015-4473				SEC21-T06S-R26E
AMC 433209	ROCKSTAR 810	2015-4474				SEC21-T06S-R26E
AMC 433210	ROCKSTAR 811	2015-4475				SEC21-T06S-R26E
AMC 433211	ROCKSTAR 812	2015-4476				SEC21-T06S-R26E
AMC 433212	ROCKSTAR 813	2015-4477				SEC21-T06S-R26E
AMC 433213	ROCKSTAR 814	2015-4478				SEC21-T06S-R26E
AMC 433214	ROCKSTAR 815	2015-4479				SEC21-T06S-R26E
AMC 433215	ROCKSTAR 816	2015-4480				SEC21-T06S-R26E
AMC 433216	ROCKSTAR 817	2015-4481				SEC21-T06S-R26E
AMC 433217	ROCKSTAR 818	2015-4482				SEC21-T06S-R26E
AMC 433218	ROCKSTAR 819	2015-4483				SEC21-T06S-R26E
AMC 433219	ROCKSTAR 820	2015-4484				SEC21-T06S-R26E
AMC 433220	ROCKSTAR 821	2015-4485				SEC21-T06S-R26E
AMC 433221	ROCKSTAR 822	2015-4486				SEC21-T06S-R26E
AMC 433222	ROCKSTAR 823	2015-4487				SEC21-T06S-R26E
AMC 433223	ROCKSTAR 824	2015-4488				SEC21-T06S-R26E
AMC 433224	ROCKSTAR 825	2015-4489				SEC21-T06S-R26E
AMC 433225	ROCKSTAR 826	2015-4490				SEC22-T06S-R26E
AMC 433226	ROCKSTAR 827	2015-4491				SEC22-T06S-R26E
AMC 433227	ROCKSTAR 828	2015-4492				SEC22-T06S-R26E
AMC 433228	ROCKSTAR 829	2015-4493				SEC22-T06S-R26E
AMC 433229	ROCKSTAR 830	2015-4494				SEC22-T06S-R26E
AMC 433230	ROCKSTAR 831	2015-4495				SEC22-T06S-R26E
AMC 433231	ROCKSTAR 832	2015-4496				SEC22-T06S-R26E
AMC 433232	ROCKSTAR 833	2015-4497				SEC22-T06S-R26E
AMC 433233	ROCKSTAR 834	2015-4498				SEC22-T06S-R26E
AMC 433234	ROCKSTAR 835	2015-4499				SEC22-T06S-R26E
AMC 433235	ROCKSTAR 836	2015-4500				SEC22-T06S-R26E
AMC 433236	ROCKSTAR 837	2015-4501				SEC22-T06S-R26E
AMC 433237	ROCKSTAR 838	2015-4502				SEC22-T06S-R26E

Date: 7/25/2016

RECEIVED  
 BLM AZ STATE OFFICE  
 2016 AUG - 3 A 9 27  
 PHOENIX, ARIZONA  
 Page 89

# EXHIBIT A

County: Graham

State: AZ

<u>BLM Serial #</u>	<u>Claim Name</u>	<u>Original Recording</u>		<u>Amended Recording</u>		<u>Location</u>
		<u>Recording #</u>	<u>Page #</u>	<u>Recording #</u>	<u>Page #</u>	
AMC 433238	ROCKSTAR 839	2015-4503				SEC22-T06S-R26E
AMC 433239	ROCKSTAR 840	2015-4504				SEC22-T06S-R26E
AMC 433240	ROCKSTAR 841	2015-4505				SEC22-T06S-R26E
AMC 433241	ROCKSTAR 842	2015-4506				SEC22-T06S-R26E
AMC 433242	ROCKSTAR 843	2015-4507				SEC22-T06S-R26E
AMC 433243	ROCKSTAR 844	2015-4508				SEC22-T06S-R26E
AMC 433244	ROCKSTAR 845	2015-4509				SEC22-T06S-R26E
AMC 433245	ROCKSTAR 846	2015-4510				SEC22-T06S-R26E
AMC 433246	ROCKSTAR 847	2015-4511				SEC22-T06S-R26E
AMC 433247	ROCKSTAR 848	2015-4512				SEC22-T06S-R26E
AMC 433248	ROCKSTAR 849	2015-4513				SEC22-T06S-R26E
AMC 433249	ROCKSTAR 850	2015-4514				SEC22-T06S-R26E
AMC 433250	ROCKSTAR 851	2015-4515				SEC22-T06S-R26E
AMC 433251	ROCKSTAR 852	2015-4516				SEC22-T06S-R26E
AMC 433252	ROCKSTAR 853	2015-4517				SEC22-T06S-R26E
AMC 433253	ROCKSTAR 854	2015-4518				SEC22-T06S-R26E
AMC 433254	ROCKSTAR 855	2015-4519				SEC22-T06S-R26E
AMC 433255	ROCKSTAR 856	2015-4520				SEC22-T06S-R26E
AMC 433256	ROCKSTAR 857	2015-4521				SEC22-T06S-R26E
AMC 433257	ROCKSTAR 858	2015-4522				SEC22-T06S-R26E
AMC 433258	ROCKSTAR 859	2015-4523				SEC22-T06S-R26E
AMC 433259	ROCKSTAR 860	2015-4524				SEC22-T06S-R26E
AMC 433260	ROCKSTAR 861	2015-4525				SEC22-T06S-R26E
AMC 433261	ROCKSTAR 862	2015-4526				SEC27-T06S-R26E
AMC 433262	ROCKSTAR 863	2015-4527				SEC27-T06S-R26E
AMC 433263	ROCKSTAR 864	2015-4528				SEC27-T06S-R26E
AMC 433264	ROCKSTAR 865	2015-4529				SEC27-T06S-R26E
AMC 433265	ROCKSTAR 866	2015-4530				SEC27-T06S-R26E
AMC 433266	ROCKSTAR 867	2015-4531				SEC27-T06S-R26E
AMC 433267	ROCKSTAR 868	2015-4532				SEC27-T06S-R26E
AMC 433268	ROCKSTAR 869	2015-4533				SEC27-T06S-R26E
AMC 433269	ROCKSTAR 870	2015-4534				SEC27-T06S-R26E
AMC 433270	ROCKSTAR 871	2015-4535				SEC27-T06S-R26E
AMC 433271	ROCKSTAR 872	2015-4536				SEC27-T06S-R26E
AMC 433272	ROCKSTAR 873	2015-4537				SEC27-T06S-R26E
AMC 433273	ROCKSTAR 874	2015-4538				SEC27-T06S-R26E
AMC 433274	ROCKSTAR 875	2015-4539				SEC27-T06S-R26E
AMC 433275	ROCKSTAR 876	2015-4540				SEC27-T06S-R26E

Date: 7/25/2016

RECEIVED  
BLM AZ STATE OFFICE  
2016 AUG - 3 A 9 28  
PHOENIX, ARIZONA

## EXHIBIT A

County: Graham

State: AZ

BLM Serial #	Claim Name	Original Recording		Amended Recording		Location
		Recording #	Page #	Recording #	Page #	
AMC 433276	ROCKSTAR 877	2015-4541				SEC27-T06S-R26E
AMC 433277	ROCKSTAR 878	2015-4542				SEC27-T06S-R26E
AMC 433278	ROCKSTAR 879	2015-4543				SEC27-T06S-R26E
AMC 433279	ROCKSTAR 880	2015-4544				SEC27-T06S-R26E
AMC 433280	ROCKSTAR 881	2015-4545				SEC27-T06S-R26E
AMC 433281	ROCKSTAR 882	2015-4546				SEC28-T06S-R26E
AMC 433282	ROCKSTAR 883	2015-4547				SEC28-T06S-R26E
AMC 433283	ROCKSTAR 884	2015-4548				SEC28-T06S-R26E
AMC 433284	ROCKSTAR 885	2015-4549				SEC28-T06S-R26E
AMC 433285	ROCKSTAR 886	2015-4550				SEC28-T06S-R26E
AMC 433286	ROCKSTAR 887	2015-4551				SEC28-T06S-R26E
AMC 433287	ROCKSTAR 888	2015-4552				SEC28-T06S-R26E
AMC 433288	ROCKSTAR 889	2015-4553				SEC28-T06S-R26E
AMC 433289	ROCKSTAR 890	2015-4554				SEC28-T06S-R26E
AMC 433290	ROCKSTAR 891	2015-4555				SEC28-T06S-R26E
AMC 433291	ROCKSTAR 892	2015-4556				SEC28-T06S-R26E
AMC 433292	ROCKSTAR 893	2015-4557				SEC28-T06S-R26E
AMC 433293	ROCKSTAR 894	2015-4558				SEC28-T06S-R26E
AMC 433294	ROCKSTAR 895	2015-4559				SEC28-T06S-R26E
AMC 433295	ROCKSTAR 896	2015-4560				SEC28-T06S-R26E
AMC 433296	ROCKSTAR 897	2015-4561				SEC28-T06S-R26E
AMC 433297	ROCKSTAR 898	2015-4562				SEC28-T06S-R26E
AMC 433298	ROCKSTAR 899	2015-4563				SEC28-T06S-R26E
AMC 433299	ROCKSTAR 900	2015-4564				SEC28-T06S-R26E
AMC 433300	ROCKSTAR 901	2015-4565				SEC28-T06S-R26E
AMC 433301	ROCKSTAR 902	2015-4566				SEC28-T06S-R26E
AMC 433302	ROCKSTAR 903	2015-4567				SEC28-T06S-R26E
AMC 433303	ROCKSTAR 904	2015-4568				SEC28-T06S-R26E
AMC 433304	ROCKSTAR 905	2015-4569				SEC28-T06S-R26E
AMC 433305	ROCKSTAR 906	2015-4570				SEC28-T06S-R26E
AMC 433306	ROCKSTAR 907	2015-4571				SEC28-T06S-R26E
AMC 433307	ROCKSTAR 908	2015-4572				SEC28-T06S-R26E
AMC 433308	ROCKSTAR 909	2015-4573				SEC28-T06S-R26E
AMC 433309	ROCKSTAR 910	2015-4574				SEC28-T06S-R26E
AMC 433310	ROCKSTAR 911	2015-4575				SEC29-T06S-R26E
AMC 433311	ROCKSTAR 912	2015-4576				SEC29-T06S-R26E
AMC 433312	ROCKSTAR 913	2015-4577				SEC29-T06S-R26E
AMC 433313	ROCKSTAR 914	2015-4578				SEC29-T06S-R26E

Date: 7/25/2016

RECEIVED  
BLM AZ STATE OFFICE

Page 91

PHOENIX, ARIZONA  
2016 AUG - 3 A 9: 28



## EXHIBIT A

County: Graham

State: AZ

<u>BLM Serial #</u>	<u>Claim Name</u>	<u>Original Recording</u>		<u>Amended Recording</u>		<u>Location</u>
		<u>Recording #</u>	<u>Page #</u>	<u>Recording #</u>	<u>Page #</u>	
AMC 433314	ROCKSTAR 915	2015-4579				SEC29-T06S-R26E
AMC 433315	ROCKSTAR 916	2015-4580				SEC29-T06S-R26E
AMC 433316	ROCKSTAR 917	2015-4581				SEC29-T06S-R26E
AMC 433317	ROCKSTAR 918	2015-4582				SEC29-T06S-R26E
AMC 433318	ROCKSTAR 919	2015-4583				SEC29-T06S-R26E
AMC 433319	ROCKSTAR 920	2015-4584				SEC29-T06S-R26E
AMC 433320	ROCKSTAR 921	2015-4585				SEC29-T06S-R26E
AMC 433321	ROCKSTAR 922	2015-4586				SEC29-T06S-R26E
AMC 433322	ROCKSTAR 923	2015-4587				SEC29-T06S-R26E
AMC 433323	ROCKSTAR 924	2015-4588				SEC29-T06S-R26E
AMC 433324	ROCKSTAR 925	2015-4589				SEC29-T06S-R26E
AMC 433325	ROCKSTAR 926	2015-4590				SEC29-T06S-R26E
AMC 433326	ROCKSTAR 927	2015-4591				SEC29-T06S-R26E
AMC 433327	ROCKSTAR 928	2015-4592				SEC29-T06S-R26E
AMC 433328	ROCKSTAR 929	2015-4593				SEC30-T06S-R26E
AMC 433329	ROCKSTAR 930	2015-4594				SEC30-T06S-R26E
AMC 433330	ROCKSTAR 931	2015-4595				SEC30-T06S-R26E
AMC 433331	ROCKSTAR 932	2015-4596				SEC30-T06S-R26E
AMC 433332	ROCKSTAR 933	2015-4597				SEC30-T06S-R26E
AMC 433333	ROCKSTAR 934	2015-4598				SEC30-T06S-R26E
AMC 433334	ROCKSTAR 935	2015-4599				SEC30-T06S-R26E
AMC 433335	ROCKSTAR 936	2015-4600				SEC30-T06S-R26E
AMC 433336	ROCKSTAR 937	2015-4601				SEC30-T06S-R26E
AMC 433337	ROCKSTAR 938	2015-4602				SEC30-T06S-R26E
AMC 433338	ROCKSTAR 939	2015-4603				SEC30-T06S-R26E
AMC 433339	ROCKSTAR 940	2015-4604				SEC30-T06S-R26E
AMC 433340	ROCKSTAR 941	2015-4605				SEC30-T06S-R26E
AMC 433341	ROCKSTAR 942	2015-4606				SEC30-T06S-R26E
AMC 433342	ROCKSTAR 943	2015-4607				SEC30-T06S-R26E
AMC 433343	ROCKSTAR 944	2015-4608				SEC30-T06S-R26E
AMC 433344	ROCKSTAR 945	2015-4609				SEC30-T06S-R26E
AMC 433345	ROCKSTAR 946	2015-4610				SEC30-T06S-R26E
AMC 433346	ROCKSTAR 947	2015-4611				SEC30-T06S-R26E
AMC 433347	ROCKSTAR 948	2015-4612				SEC30-T06S-R26E
AMC 433348	ROCKSTAR 949	2015-4613				SEC30-T06S-R26E
AMC 433349	ROCKSTAR 950	2015-4614				SEC30-T06S-R26E
AMC 433350	ROCKSTAR 951	2015-4615				SEC30-T06S-R26E
AMC 433351	ROCKSTAR 952	2015-4616				SEC30-T06S-R26E

Date: 7/25/2016

Page 92

RECEIVED  
 BLM AZ STATE OFFICE  
 2016 AUG - 3 A 9 28  
 PHOENIX, ARIZONA

## EXHIBIT A

County: Graham

State: AZ

<u>BLM Serial #</u>	<u>Claim Name</u>	<u>Original Recording</u>		<u>Amended Recording</u>		<u>Location</u>
		<u>Recording #</u>	<u>Page #</u>	<u>Recording #</u>	<u>Page #</u>	
AMC 433352	ROCKSTAR 953	2015-4617				SEC30-T06S-R26E
AMC 433353	ROCKSTAR 954	2015-4618				SEC30-T06S-R26E
AMC 433354	ROCKSTAR 955	2015-4619				SEC30-T06S-R26E
AMC 433355	ROCKSTAR 956	2015-4620				SEC31-T06S-R26E
AMC 433356	ROCKSTAR 957	2015-4621				SEC31-T06S-R26E
AMC 433357	ROCKSTAR 958	2015-4622				SEC32-T06S-R26E
AMC 433358	ROCKSTAR 959	2015-4623				SEC32-T06S-R26E
AMC 433359	ROCKSTAR 960	2015-4624				SEC31-T06S-R26E
AMC 433360	ROCKSTAR 961	2015-4625				SEC31-T06S-R26E
AMC 433361	ROCKSTAR 962	2015-4626				SEC31-T06S-R26E
AMC 433362	ROCKSTAR 963	2015-4627				SEC31-T06S-R26E
AMC 433363	ROCKSTAR 964	2015-4628				SEC31-T06S-R26E
AMC 433364	ROCKSTAR 965	2015-4629				SEC31-T06S-R26E
AMC 433365	ROCKSTAR 966	2015-4630				SEC31-T06S-R26E
AMC 433366	ROCKSTAR 967	2015-4631				SEC31-T06S-R26E
AMC 433367	ROCKSTAR 968	2015-4632				SEC31-T06S-R26E
AMC 433368	ROCKSTAR 969	2015-4633				SEC31-T06S-R26E
AMC 433369	ROCKSTAR 970	2015-4634				SEC31-T06S-R26E
AMC 433370	ROCKSTAR 971	2015-4635				SEC31-T06S-R26E
AMC 433371	ROCKSTAR 973	2015-4636				SEC31-T06S-R26E
AMC 433372	ROCKSTAR 974	2015-4637				SEC32-T06S-R26E
AMC 433373	ROCKSTAR 975	2015-4638				SEC31-T06S-R26E
AMC 433374	ROCKSTAR 976	2015-4639				SEC31-T06S-R26E
AMC 433375	ROCKSTAR 977	2015-4640				SEC32-T06S-R26E
AMC 433376	ROCKSTAR 978	2015-4641				SEC32-T06S-R26E
AMC 433377	ROCKSTAR 979	2015-4642				SEC32-T06S-R26E
AMC 433378	ROCKSTAR 980	2015-4643				SEC32-T06S-R26E
AMC 433379	ROCKSTAR 981	2015-4644				SEC32-T06S-R26E
AMC 433380	ROCKSTAR 982	2015-4645				SEC32-T06S-R26E
AMC 433381	ROCKSTAR 983	2015-4646				SEC32-T06S-R26E
AMC 433382	ROCKSTAR 984	2015-4647				SEC32-T06S-R26E
AMC 433383	ROCKSTAR 985	2015-4648				SEC32-T06S-R26E
AMC 433384	ROCKSTAR 986	2015-4649				SEC32-T06S-R26E
AMC 433385	ROCKSTAR 987	2015-4650				SEC32-T06S-R26E
AMC 433386	ROCKSTAR 988	2015-4651				SEC32-T06S-R26E
AMC 433387	ROCKSTAR 989	2015-4652				SEC32-T06S-R26E
AMC 433388	ROCKSTAR 990	2015-4653				SEC32-T06S-R26E
AMC 433389	ROCKSTAR 991	2015-4654				SEC33-T06S-R26E

Date: 7/25/2016

RECEIVED  
BLM AZ STATE OFFICE  
2016 AUG - 3 A 9 28  
PHOENIX, ARIZONA

## EXHIBIT A

County: Graham

State: AZ

BLM Serial #	Claim Name	Original Recording		Amended Recording		Location
		Recording #	Page #	Recording #	Page #	
AMC 433390	ROCKSTAR 992	2015-4655				SEC33-T06S-R26E
AMC 433391	ROCKSTAR 993	2015-4656				SEC33-T06S-R26E
AMC 433392	ROCKSTAR 994	2015-4657				SEC33-T06S-R26E
AMC 433393	ROCKSTAR 995	2015-4658				SEC33-T06S-R26E
AMC 433394	ROCKSTAR 996	2015-4659				SEC33-T06S-R26E
AMC 433395	ROCKSTAR 997	2015-4660				SEC33-T06S-R26E
AMC 433396	ROCKSTAR 998	2015-4661				SEC33-T06S-R26E
AMC 433397	ROCKSTAR 999	2015-4662				SEC33-T06S-R26E
AMC 433398	ROCKSTAR 1000	2015-4663				SEC33-T06S-R26E
AMC 433399	ROCKSTAR 1001	2015-4664				SEC33-T06S-R26E
AMC 433400	ROCKSTAR 1002	2015-4665				SEC33-T06S-R26E
AMC 433401	ROCKSTAR 1003	2015-4666				SEC32-T06S-R26E
AMC 433402	ROCKSTAR 1004	2015-4667				SEC32-T06S-R26E
AMC 433403	ROCKSTAR 1005	2015-4668				SEC32-T06S-R26E
AMC 433404	ROCKSTAR 1006	2015-4669				SEC33-T06S-R26E
AMC 433405	ROCKSTAR 1007	2015-4670				SEC33-T06S-R26E
AMC 433406	ROCKSTAR 1008	2015-4671				SEC28-T06S-R26E
AMC 433439	Red Bull-681	2015-4746				SEC22-T05S-R26E
AMC 433440	Red Bull-682	2015-4747				SEC22-T05S-R26E
AMC 433441	Red Bull-683	2015-4748				SEC22-T05S-R26E
AMC 433442	Red Bull-684	2015-4749				SEC22-T05S-R26E
AMC 433443	Red Bull-685	2015-4750				SEC22-T05S-R26E
AMC 433444	Red Bull-686	2015-4751				SEC22-T05S-R26E
AMC 433445	Red Bull-687	2015-4752				SEC22-T05S-R26E
AMC 433446	Red Bull-688	2015-4753				SEC22-T05S-R26E
AMC 433447	Red Bull-689	2015-4754				SEC22-T05S-R26E
AMC 433448	Red Bull-690	2015-4755				SEC22-T05S-R26E
AMC 433449	Red Bull-691	2015-4756				SEC22-T05S-R26E
AMC 433450	Red Bull-692	2015-4757				SEC22-T05S-R26E
AMC 433451	Red Bull-693	2015-4758				SEC22-T05S-R26E
AMC 433452	Red Bull-694	2015-4759				SEC22-T05S-R26E
AMC 433453	Red Bull-695	2015-4760				SEC22-T05S-R26E
AMC 433454	Red Bull-696	2015-4761				SEC22-T05S-R26E
AMC 433455	Red Bull-697	2015-4762				SEC22-T05S-R26E
AMC 433456	Red Bull-698	2015-4763				SEC22-T05S-R26E
AMC 433457	Red Bull-699	2015-4764				SEC09-T05S-R26E
AMC 433458	Red Bull-700	2015-4765				SEC09-T05S-R26E
AMC 433459	Red Bull-701	2015-4766				SEC09-T05S-R26E

Date: 7/25/2016

RECEIVED  
 BLM AZ STATE OFFICE  
 2016 AUG - 3 A @ 28  
 PHOENIX, ARIZONA

## EXHIBIT A

County: Graham

State: AZ

<u>BLM Serial #</u>	<u>Claim Name</u>	<u>Original Recording</u>		<u>Amended Recording</u>		<u>Location</u>
		<u>Recording #</u>	<u>Page #</u>	<u>Recording #</u>	<u>Page #</u>	
AMC 433460	Red Bull-702	2015-4767				SEC09-T05S-R26E
AMC 433461	Red Bull-703	2015-4768				SEC09-T05S-R26E
AMC 433462	Red Bull-704	2015-4769				SEC09-T05S-R26E
AMC 433463	Red Bull-705	2015-4770				SEC09-T05S-R26E
AMC 433464	Red Bull-706	2015-4771				SEC09-T05S-R26E
AMC 433465	Red Bull-707	2015-4772				SEC09-T05S-R26E
AMC 433466	Red Bull-708	2015-4773				SEC09-T05S-R26E
AMC 433467	Red Bull-709	2015-4774				SEC09-T05S-R26E
AMC 433468	Red Bull-710	2015-4775				SEC09-T05S-R26E
AMC 433469	Red Bull-711	2015-4776				SEC09-T05S-R26E
AMC 433470	Red Bull-712	2015-4777				SEC09-T05S-R26E
AMC 433471	Red Bull-713	2015-4778				SEC09-T05S-R26E
AMC 433472	Red Bull-714	2015-4779				SEC09-T05S-R26E
AMC 433473	Red Bull-715	2015-4780				SEC09-T05S-R26E
AMC 433474	Red Bull-716	2015-4781				SEC09-T05S-R26E
AMC 433475	Red Bull-717	2015-4782				SEC09-T05S-R26E
AMC 433476	Red Bull-718	2015-4783				SEC09-T05S-R26E
AMC 433477	Red Bull-719	2015-4784				SEC09-T05S-R26E
AMC 433478	Red Bull-720	2015-4785				SEC09-T05S-R26E
AMC 433479	Red Bull-721	2015-4786				SEC09-T05S-R26E
AMC 433480	Red Bull-722	2015-4787				SEC09-T05S-R26E
AMC 433481	Red Bull-723	2015-4788				SEC09-T05S-R26E
AMC 433482	Red Bull-724	2015-4789				SEC09-T05S-R26E
AMC 433483	Red Bull-725	2015-4790				SEC09-T05S-R26E
AMC 433484	Red Bull-726	2015-4791				SEC09-T05S-R26E
AMC 433485	Red Bull-727	2015-4792				SEC09-T05S-R26E
AMC 433486	Red Bull-728	2015-4793				SEC09-T05S-R26E
AMC 433487	Red Bull-729	2015-4794				SEC09-T05S-R26E
AMC 433488	Red Bull-730	2015-4795				SEC09-T05S-R26E
AMC 433489	Red Bull-731	2015-4796				SEC09-T05S-R26E
AMC 433490	Red Bull-732	2015-4797				SEC09-T05S-R26E
AMC 433491	Red Bull-733	2015-4798				SEC09-T05S-R26E
AMC 433492	Red Bull-734	2015-4799				SEC04-T05S-R26E
AMC 433493	Red Bull-735	2015-4800				SEC04-T05S-R26E
AMC 433494	Red Bull-736	2015-4801				SEC04-T05S-R26E
AMC 433495	Red Bull-737	2015-4802				SEC05-T05S-R26E
AMC 433496	Red Bull-738	2015-4803				SEC05-T05S-R26E
AMC 433497	Red Bull-739	2015-4804				SEC05-T05S-R26E

Date: 7/25/2016

RECEIVED  
BLM AZ STATE OFFICE  
2016 AUG - 3 A 9 28  
PHOENIX, ARIZONA

## EXHIBIT A

County: Graham

State: AZ

<u>BLM Serial #</u>	<u>Claim Name</u>	<u>Original Recording</u>		<u>Amended Recording</u>		<u>Location</u>
		<u>Recording #</u>	<u>Page #</u>	<u>Recording #</u>	<u>Page #</u>	
AMC 78650	Melody #1	77	472			SEC11-T06S-R26E
AMC 78651	Melody #5	77	474			SEC11-T06S-R26E
AMC 78652	Melody #7	77	475			SEC11-T06S-R26E
AMC 78653	Melody #9	77	476			SEC11-T06S-R26E
AMC 78654	Melody #11	77	477			SEC11-T06S-R26E
AMC 78655	Melody #8	77	490			SEC11-T06S-R26E
AMC 78656	Melody #10	77	491			SEC11-T06S-R26E
AMC 78657	Melody #18	77	495			SEC14-T06S-R26E
AMC 78658	Melody #20	77	496			SEC14-T06S-R26E
AMC 78659	Melody #13	77	478			SEC11-T06S-R26E
AMC 78660	Melody #17	77	480			SEC14-T06S-R26E
AMC 78661	Melody #19	77	481			SEC14-T06S-R26E
AMC 78662	Melody #21	77	482			SEC14-T06S-R26E
AMC 78663	Melody #23	77	483			SEC14-T06S-R26E
AMC 78664	Melody #27	77	485			SEC14-T06S-R26E
AMC 78665	Melody #29	77	486			SEC14-T06S-R26E
AMC 78666	Melody #31	257	540			SEC14-T06S-R26E
AMC 78667	Melody #32	257	541			SEC14-T06S-R26E
AMC 78668	Melody #16	77	494			SEC11-T06S-R26E
AMC 78669	Melody #3	77	473			SEC11-T06S-R26E
AMC 78670	Melody #15	77	479			SEC11-T06S-R26E
AMC 78671	Melody #25	77	484			SEC14-T06S-R26E
<b>No. Of Claims</b>	3632					

Date: 7/25/2016

RECEIVED  
 BLM AZ STATE OFFICE  
 2016 AUG - 3 A 9 28  
 PHOENIX, ARIZONA

**United States Department of the Interior  
Bureau of Land Management**  
DIV OF LANDS, MINRLS & ENERGY  
ONE N CENTRAL AVE  
PHOENIX, AZ 85004 -4427  
Phone: 602-417-9200

Receipt

No: 3620300

<b>Transaction #:</b> 3723964	
<b>Date of Transaction:</b> 08/03/2016	
<b>CUSTOMER:</b>	
FREEPORT MINERALS CORPORATION LAND AND WATER DEPARTMENT 333 NORTH CENTRAL AVE PHOENIX, AZ 85004 US	

LINE #	QTY	DESCRIPTION	REMARKS	UNIT PRICE	TOTAL
1	1.00	LOCATABLE MINERALS / MINING CLAIMS- NOT NEW-UNADJUD, ONE AUTH NO. ONLY / MINING CLAIM MONEY RECEIVED CASES: AMC46122/\$562960.00	MAINT 2017/3632	- n/a -	562960.00
<b>TOTAL:</b>					<b>\$562,960.00</b>

PAYMENT INFORMATION			
1	AMOUNT:	562960.00	POSTMARKED: N/A
	TYPE:	CHECK	RECEIVED: 08/03/2016
	CHECK NO:	0000862592	
	NAME:	FREEPORT MINERALS CORPORATION LAND AND WATER DEPARTMENT 333 NORTH CENTRAL AVE PHOENIX AZ 85004 US	

REMARKS

This receipt was generated by the automated BLM Collections and Billing System and is a paper representation of a portion of the official electronic record contained therein.

**ENTERED**  
AUG - 4 2016  
BY: *[Signature]*

**NOTICE!!**

**These documents have been scanned!**

**Do not place un-scanned documents beneath this notice!**

**Do not remove this notice from this file!**

GPO Jacket No. 560-102  
Print Order 61540  
Rise Business Services, LLC  
Job=AZ15 5/8/2019



Box Number= AZ15026



Claim Begin-End: AMC432120-AMC432235

5 Miscellaneous



AZ15026-5

AMC431791-AMC432478

**NO  
DOCUMENTS  
FOUND**

NO DOCUMENTS FOUND  
NO DOCUMENTS FOUND



**NOTICE!!**

**These documents have been scanned!**

**Do not place un-scanned documents beneath this notice!**

**Do not remove this notice from this file!**

GPO Jacket No. 560-102  
Print Order 61540  
Rise Business Services, LLC  
Job=AZ15 5/8/2019



Box Number= AZ15026



Claim Begin-End: AMC432120-AMC432235

6 Location Notices-Amendments and Supporting Documents



AZ15026-5

AMC431791-AMC432478

# MINING CLAIM STATUS REPORT

Data Entered: 05/15/15 RAm

MTP Checked By: 05/18/15  
GEO Checked By: 05/18/15

LEAD SERIAL NUMBER: AMC 432120 thru AMC 432235

### NUMBER OF CLAIMS & TYPE:

- 116 LODE
- PLACER
- ASSOCIATION PLACER
- MILL SITE
- TUNNEL SITE

### CHARGES:

- Location Fee @ \$37 = \$ 4292
- Processing Fee @ \$20 = \$ 2320
- Maintenance Fee @ \$155 = \$ 17980
- Add'l Maint Fee for Assoc Placer = \$
- SUBTOTAL** \$ 24592
- 2016 MAINT. Other Fees \$ 17980
- Other Fees \$
- TOTAL** \$ 42572

TOTAL ACREAGE: \_\_\_\_\_ Per Claim  
(Placer Only)

NUMBER OF LOCATORS: \_\_\_\_\_

DOCUMENTS RECEIVED VIA: Over-the-Counter  Mail  TIMELY FILED: Yes  No

LEGAL DESCRIPTION:	T	R	SEC
	<u>5S</u>	<u>25E</u>	<u>13, 14, 23, 25, 24</u>
	<u>5S</u>	<u>27E</u>	<u>6, 7, 18, 19, 30</u>
	<u>5S</u>	<u>26E</u>	<u>1, 2, 11, 12, 13, 14, 36</u>

BLM  FOREST SERVICE  SUBJ TO PL 359: Yes  No   
WILDERNESS AREA

SPLIT ESTATE: N/A  SX  PX  OTHER   
SRHA  Was proper Notice filed if located on SHRA Land? Yes  No

RECONVEYED MINERALS ON BLM LAND REQUIRE OPENING ORDER FROM 1944 TO 1993:  
Open to Entry On \_\_\_\_\_ N/A

COMMENTS/STATUS: VOID  PARTIALLY VOID  PVT MINERALS  WITHDRAWN LANDS   
OTHER

AMC 432174, 432175, 432178 } The following claims enter upon lands that are patented or w/dn: AMC 432174, 432175, 432178 have portions that enter into lands patented by 02-69-0058 [REDACTED]

AMC 432200 has a small portion in lands w/dn by EO 11/9/1871 (White Mtn Apache Ind)

The Fed govt does not own the mineral estate & the rights to mine are conveyed (Res by the Fed govt)

Claimant acknowledges that portions of the following claim(s) site(s) may be void or voidable.

Printed Name of Claimant \_\_\_\_\_ Signature of Claimant \_\_\_\_\_

\*\*\*\*\*FINAL ADJUDICATION\*\*\*\*\*

DATE 10-27-16 INITIALS RE

AMC 432120

# Lodes to Note

---

AMC 432174

Pat 02-69-0058, AZA 32935

AMC 432175

~~Pat 02-69-0058~~, AZA 32935

AMC 432176

AMC 432178

Pat 02-69-0058

AMC 432200

~~Pat 02-69-0058~~ 11/9/1871  
NEVENENE

wdl white mtn Apache  
Ind Res  
Lot (part)

**LOCATION NOTICE FOR LODE MINING CLAIM**

Amendment      BLM Serial # \_\_\_\_\_

NOTICE IS HEREBY GIVEN that the Red Bull - 361

\_\_\_\_\_ lode mining claim has been located

by Freeport Minerals Corporation whose current mailing

address is P.O. Box 1019

Safford, Arizona 85548

BLM  
Date  
Stamp

RECEIVED  
BLM AZ STATE OFFICE  
2015 MAY -6 A 9:25  
PHOENIX, ARIZONA

The general course of this claim is East To West and it is situated in Graham

County, Arizona. This claim is 1450 feet in length and 600 feet in width.

20.0 Total Claim Acreage. This claim runs from the location monument on which this location notice

is posted on the centerline of the claim approximately 10 feet in a Westerly direction to the West

end line and 1440 feet in a Easterly direction to the East end line. This claim is marked by six

monuments, one at each corner and one at the center of each end line of the claim.

The location monument on which this notice is posted is situated within Section 14 Township 5

S, Range 25 E, Gila Salt River Base and Meridian, Arizona and this claim encompasses portions

of the following quarter section(s), section(s), Township(s) and Range(s) SE 1/4

Section 14 Township 5S Range 25E and NE 1/4 Section 23, Township 5S, Range 25E

Gila Salt River Base and Meridian, Arizona.

The locality of this claim with reference to some natural object or permanent monument and additional information

(if any) concerning its locality are as follows: The Northeast corner of the claim is 4800' South and 440' West of the monument at the

Northeast Corner of Section 14, Township 5S, Range 25E on the section line.

The above information is shown on the attached map.

DATED AND POSTED on the ground this 6 day of April, 2015.

LOCATOR(s)       AGENT

Print Name(s) Entellus, Inc. - Daniel G. Francetic, RLS

Signature(s) *Daniel G. Francetic*

Form MCF100  
Revised July 2014

AMC 432120



# RED BULL - 361 CLAIM

## LOCATION OF RED BULL-361 THROUGH RED BULL-396 LODE CLAIMS

LOCATED IN SECTIONS 14 & 23, T.5S., R.25E.

GRAHAM COUNTY, ARIZONA

ALL CLAIMS ARE 1450' IN LENGTH AND 600' IN WIDTH UNLESS NOTED

SEC. COR.  
10/11/14/15  
T.5S., R.25E.

SEC. COR.  
11/12/13/14  
T.5S., R.25E.

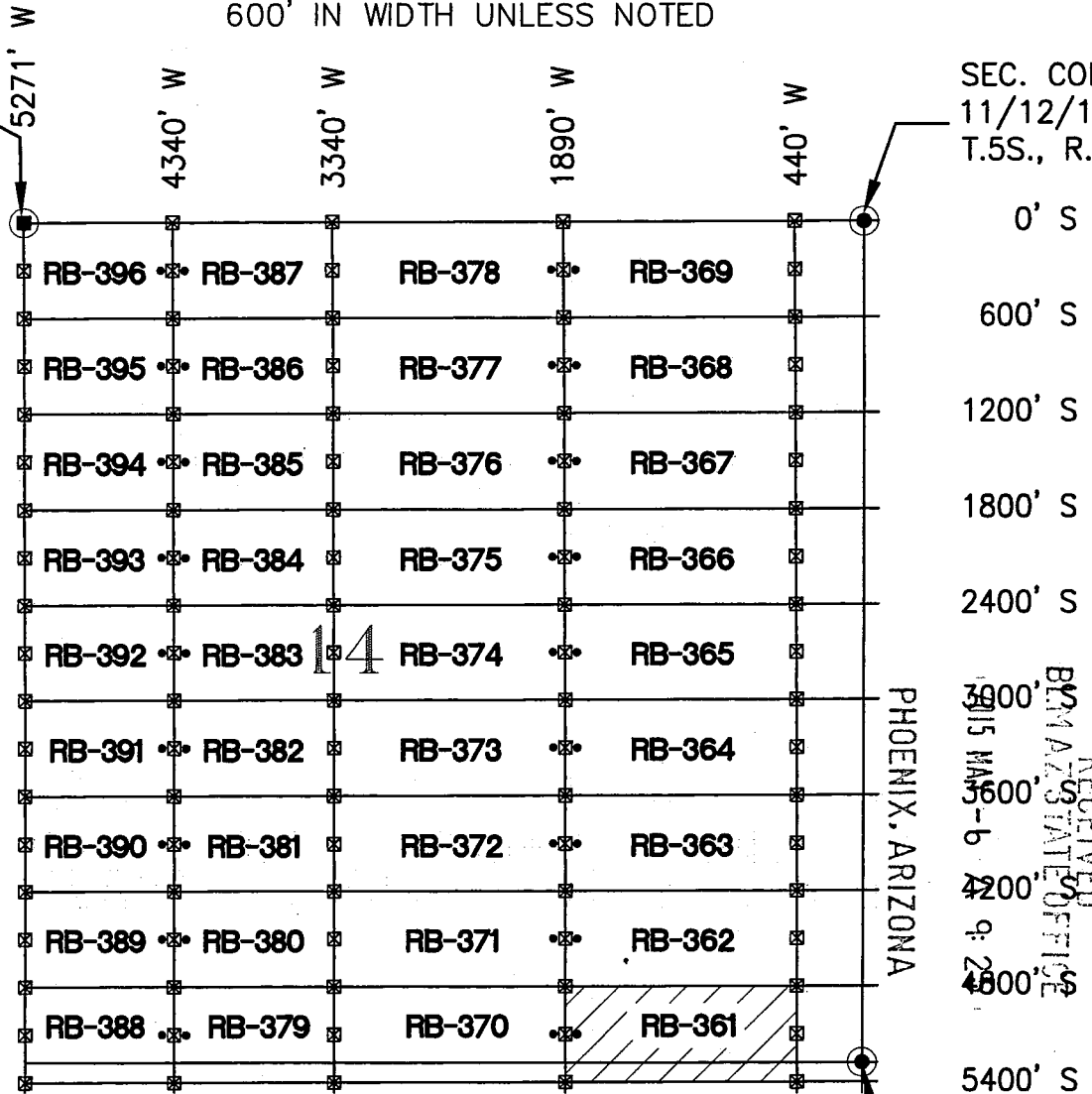

PHOENIX, ARIZONA

0' S  
600' S  
1200' S  
1800' S  
2400' S  
3000' S  
3600' S  
4200' S  
4800' S  
5400' S

SEC. COR.  
13/14/23/24  
T.5S., R.25E.



RECEIVED  
BUREAU OF STATE OFFICE  
MAY-6 2009

AMC 132120

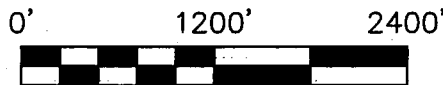
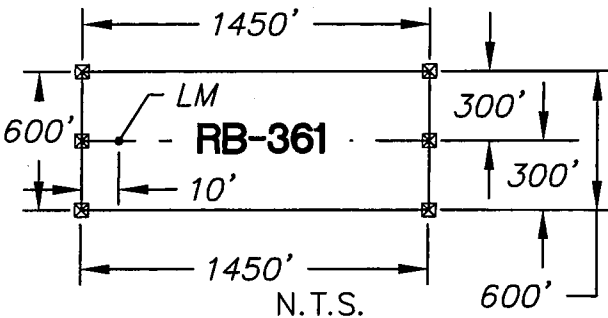

INDICATES CORNER OF LODE CLAIM.  
SET 2"x2"x5' WOODEN POST (TYPICAL)

INDICATES LOCATION  
MONUMENT. SET 2"x2"x5'  
WOODEN POST WITH SIGN  
(TYPICAL)

LOCATORS:  
FREEPORT MINERALS CORP.  
PO BOX 1019  
SAFFORD AZ 85548

CLAIM ACREAGE = 20.0 AC  
WC = WITNESS CORNER NORTH  
OF SIDE LINE

 **Entellus™**  
2255 N. 44th Street Suite 125  
Phoenix, AZ 85008.3279  
Tel 602.244.2566  
Fax 602.244.8947  
Website: www.Entellus.com

**LOCATION NOTICE FOR LODE MINING CLAIM**

Amendment      BLM Serial # \_\_\_\_\_

NOTICE IS HEREBY GIVEN that the Red Bull - 362

\_\_\_\_\_ lode mining claim has been located

by Freeport Minerals Corporation whose current mailing

address is P.O. Box 1019

\_\_\_\_\_ Safford, Arizona 85548

The general course of this claim is East To West and it is situated in \_\_\_\_\_ Graham

County, Arizona. This claim is 1450 feet in length and 600 feet in width.

20.0 Total Claim Acreage. This claim runs from the location monument on which this location notice

is posted on the centerline of the claim approximately 10 feet in a Westerly direction to the West

end line and 1440 feet in a Easterly direction to the East end line. This claim is marked by six

monuments, one at each corner and one at the center of each end line of the claim.

The location monument on which this notice is posted is situated within Section 14 Township 5

S, Range 25 E, Gila Salt River Base and Meridian, Arizona and this claim encompasses portions

of the following quarter section(s), section(s), Township(s) and Range(s) SE 1/4

Section 14 Township 5S Range 25E

Gila Salt River Base and Meridian, Arizona.

The locality of this claim with reference to some natural object or permanent monument and additional information

(if any) concerning its locality are as follows: The Northeast corner of the claim is 4200' South and 440' West of the monument at the

Northeast Corner of Section 14, Township 5S, Range 25E

The above information is shown on the attached map.

DATED AND POSTED on the ground this 6 day of April, 2015.

LOCATOR(s)       AGENT

Print Name(s) Entellus, Inc. - Daniel G. Francetic, RLS

Signature(s) *Daniel G. Francetic*

RECEIVED  
BLM AZ STATE OFFICE  
2015 MAY -6 A 9:25  
PHOENIX, ARIZONA  
BLM  
Date  
Stamp

AMC 432121

# RED BULL - 362 CLAIM

## LOCATION OF RED BULL-361 THROUGH RED BULL-396 LODE CLAIMS

LOCATED IN SECTIONS 14 & 23, T.5S., R.25E.

GRAHAM COUNTY, ARIZONA

ALL CLAIMS ARE 1450' IN LENGTH AND 600' IN WIDTH UNLESS NOTED

SEC. COR.  
10/11/14/15  
T.5S., R.25E.

SEC. COR.  
11/12/13/14  
T.5S., R.25E.

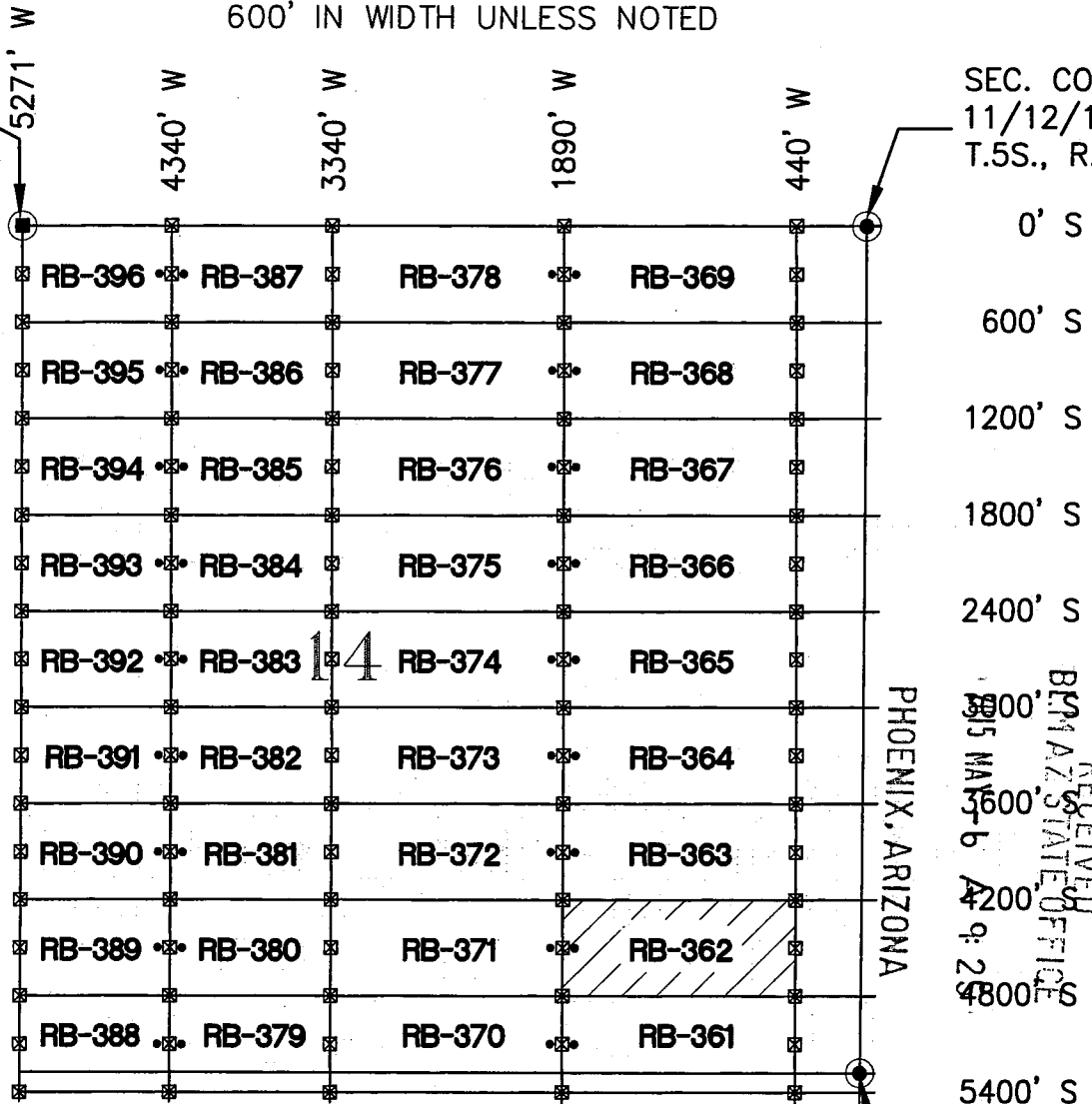

RECEIVED  
BISMARCK STATE OFFICE  
MAY 6 4 2009

SEC. COR.  
13/14/23/24  
T.5S., R.25E.

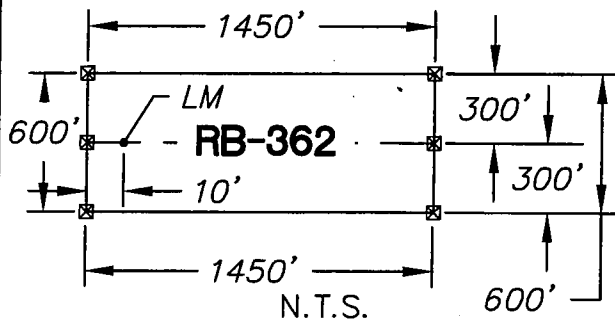

0' 1200' 2400'



☒ INDICATES CORNER OF LODE CLAIM.  
SET 2"x2"x5' WOODEN POST (TYPICAL)

• INDICATES LOCATION  
MONUMENT. SET 2"x2"x5'  
WOODEN POST WITH SIGN  
(TYPICAL)



2255 N. 44th Street Suite 125  
Phoenix, AZ 85008.3279  
Tel 602.244.2566  
Fax 602.244.8947  
Website: www.Entellus.com

LOCATORS:  
FREEPORT MINERALS CORP.  
PO BOX 1019  
SAFFORD AZ 85548

CLAIM ACREAGE = 20.0 AC  
WC = WITNESS CORNER NORTH  
OF SIDE LINE

**LOCATION NOTICE FOR LODE MINING CLAIM**

Amendment      BLM Serial # \_\_\_\_\_

NOTICE IS HEREBY GIVEN that the Red Bull - 363

\_\_\_\_\_ lode mining claim has been located

by Freeport Minerals Corporation whose current mailing

address is P.O. Box 1019

Safford, Arizona 85548

BLM  
Date  
Stamp

RECEIVED  
BLM AZ STATE OFFICE  
2015 MAY -6 A 9:25  
PHOENIX, ARIZONA

The general course of this claim is East To West and it is situated in Graham

County, Arizona. This claim is 1450 feet in length and 600 feet in width.

20.0 Total Claim Acreage. This claim runs from the location monument on which this location notice

is posted on the centerline of the claim approximately 10 feet in a Westerly direction to the West

end line and 1440 feet in a Easterly direction to the East end line. This claim is marked by six

monuments, one at each corner and one at the center of each end line of the claim.

The location monument on which this notice is posted is situated within Section 14 Township 5

S, Range 25 E, Gila Salt River Base and Meridian, Arizona and this claim encompasses portions

of the following quarter section(s), section(s), Township(s) and Range(s) SE 1/4

Section 14 Township 5S Range 25E

Gila Salt River Base and Meridian, Arizona.

The locality of this claim with reference to some natural object or permanent monument and additional information

(if any) concerning its locality are as follows: The Northeast corner of the claim is 3600' South and 440' West of the monument at the

Northeast Corner of Section 14, Township 5S, Range 25E

The above information is shown on the attached map.

DATED AND POSTED on the ground this 6 day of April, 2015.

LOCATOR(s)       AGENT

Print Name(s) Entellus, Inc. - Daniel G. Francetic, RLS

Signature(s) *Daniel G. Francetic*

Form MCF100  
Revised July 2014

AMC4321221



# RED BULL - 363 CLAIM

## LOCATION OF RED BULL-361 THROUGH RED BULL-396 LODE CLAIMS

LOCATED IN SECTIONS 14 & 23, T.5S., R.25E.

GRAHAM COUNTY, ARIZONA

ALL CLAIMS ARE 1450' IN LENGTH AND 600' IN WIDTH UNLESS NOTED

SEC. COR.  
10/11/14/15  
T.5S., R.25E.

SEC. COR.  
11/12/13/14  
T.5S., R.25E.

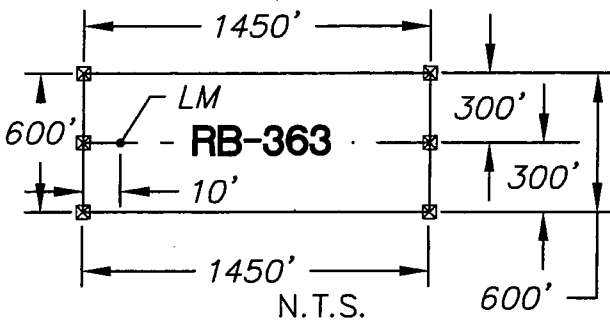
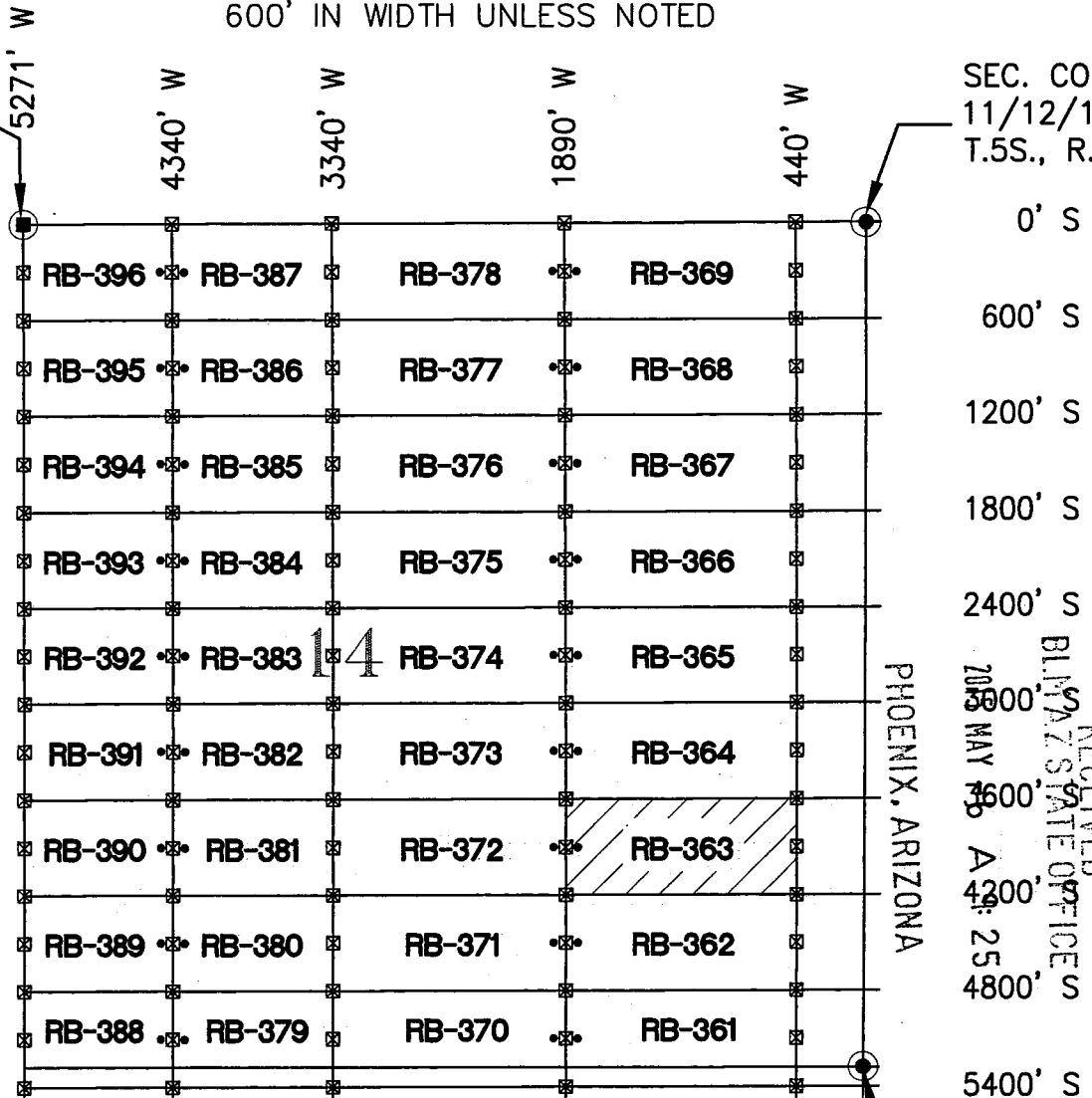

0' 1200' 2400'



- ☒ INDICATES CORNER OF LODE CLAIM. SET 2"x2"x5' WOODEN POST (TYPICAL)
- INDICATES LOCATION MONUMENT. SET 2"x2"x5' WOODEN POST WITH SIGN (TYPICAL)

LOCATORS:  
FREEPORT MINERALS CORP.  
PO BOX 1019  
SAFFORD AZ 85548

CLAIM ACREAGE = 20.0 AC  
WC = WITNESS CORNER NORTH  
OF SIDE LINE

 **Entellus™**  
2255 N. 44th Street Suite 125  
Phoenix, AZ 85008.3279  
Tel 602.244.2566  
Fax 602.244.8947  
Website: www.Entellus.com

LOCATION NOTICE FOR LODE MINING CLAIM

Amendment BLM Serial # \_\_\_\_\_

NOTICE IS HEREBY GIVEN that the Red Bull - 364

\_\_\_\_\_ lode mining claim has been located

by Freeport Minerals Corporation whose current mailing

address is P.O. Box 1019

Safford, Arizona 85548

RECEIVED  
BLM AZ STATE OFFICE  
2015 MAY -6 A 9:25  
PHOENIX, ARIZONA  
BLM  
Date  
Stamp

The general course of this claim is East To West and it is situated in Graham

County, Arizona. This claim is 1450 feet in length and 600 feet in width.

20.0 Total Claim Acreage. This claim runs from the location monument on which this location notice

is posted on the centerline of the claim approximately 10 feet in a Westerly direction to the West

end line and 1440 feet in a Easterly direction to the East end line. This claim is marked by six

monuments, one at each corner and one at the center of each end line of the claim.

The location monument on which this notice is posted is situated within Section 14 Township 5

S, Range 25 E, Gila Salt River Base and Meridian, Arizona and this claim encompasses portions

of the following quarter section(s), section(s), Township(s) and Range(s) SE 1/4

Section 14 Township 5S Range 25E

Gila Salt River Base and Meridian, Arizona.

The locality of this claim with reference to some natural object or permanent monument and additional information

(if any) concerning its locality are as follows: The Northeast corner of the claim is 3000' South and 440' West of the monument at the

Northeast Corner of Section 14, Township 5S, Range 25E

The above information is shown on the attached map.

DATED AND POSTED on the ground this 6 day of April, 2015

LOCATOR(s)  AGENT

Print Name(s) Entellus, Inc. - Daniel G. Francetic, RLS

Signature(s) *Daniel G. Francetic*

Form MCF100  
Revised July 2014

AMC4321231

# RED BULL - 364 CLAIM

## LOCATION OF RED BULL-361 THROUGH RED BULL-396 LODE CLAIMS

LOCATED IN SECTIONS 14 & 23, T.5S., R.25E.

GRAHAM COUNTY, ARIZONA

ALL CLAIMS ARE 1450' IN LENGTH AND 600' IN WIDTH UNLESS NOTED

SEC. COR.  
10/11/14/15  
T.5S., R.25E.

SEC. COR.  
11/12/13/14  
T.5S., R.25E.

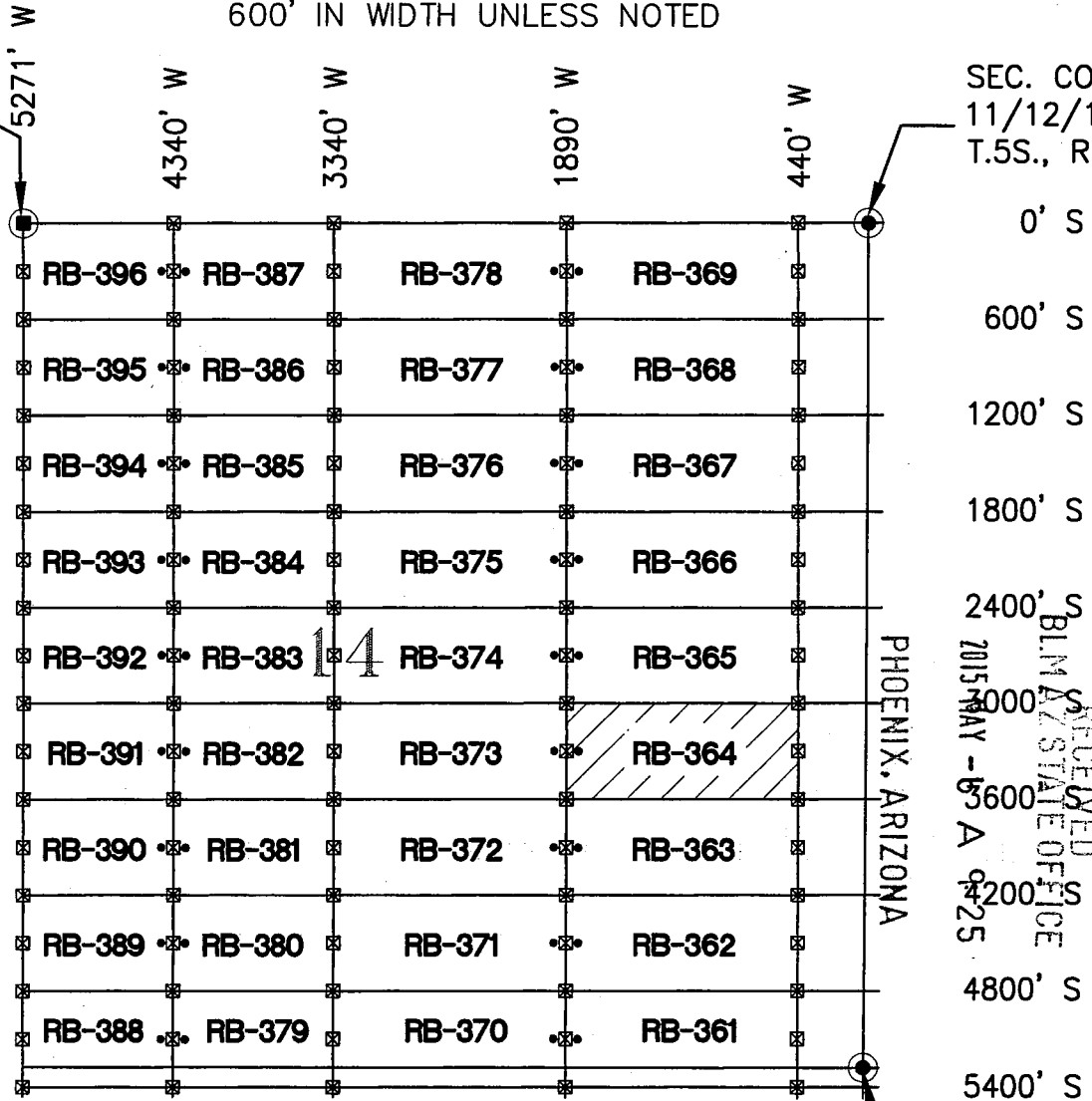

PHOENIX, ARIZONA

RECEIVED  
BLM AZ STATE OFFICE  
MAY 15 2015

SEC. COR.  
13/14/23/24  
T.5S., R.25E.

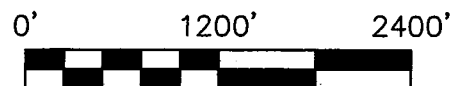
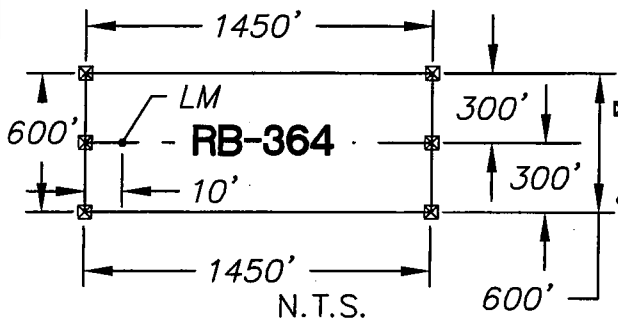

- ☒ INDICATES CORNER OF LODE CLAIM. SET 2"x2"x5' WOODEN POST (TYPICAL)
- INDICATES LOCATION MONUMENT. SET 2"x2"x5' WOODEN POST WITH SIGN (TYPICAL)

LOCATORS:  
FREEPORT MINERALS CORP.  
PO BOX 1019  
SAFFORD AZ 85548

CLAIM ACREAGE = 20.0 AC  
WC = WITNESS CORNER NORTH  
OF SIDE LINE

**Entellus™**  
2255 N. 44th Street Suite 125  
Phoenix, AZ 85008.3279  
Tel 602.244.2566  
Fax 602.244.8947  
Website: www.Entellus.com

LOCATION NOTICE FOR LODE MINING CLAIM

Amendment BLM Serial # \_\_\_\_\_

NOTICE IS HEREBY GIVEN that the Red Bull - 365

\_\_\_\_\_ lode mining claim has been located

by Freeport Minerals Corporation whose current mailing

address is P.O. Box 1019

Safford, Arizona 85548

RECEIVED  
BLM AZ STATE OFFICE  
2015 MAY -6 A 9:25  
PHOENIX, ARIZONA

BLM  
Date  
Stamp

The general course of this claim is East To West and it is situated in Graham

County, Arizona. This claim is 1450 feet in length and 600 feet in width.

20.0 Total Claim Acreage. This claim runs from the location monument on which this location notice

is posted on the centerline of the claim approximately 10 feet in a Westerly direction to the West

end line and 1440 feet in a Easterly direction to the East end line. This claim is marked by six

monuments, one at each corner and one at the center of each end line of the claim.

The location monument on which this notice is posted is situated within Section 14 Township 5

S, Range 25 E, Gila Salt River Base and Meridian, Arizona and this claim encompasses portions

of the following quarter section(s), section(s), Township(s) and Range(s) SE 1/4 and NE 1/4

Section 14 Township 5S Range 25E

Gila Salt River Base and Meridian, Arizona.

The locality of this claim with reference to some natural object or permanent monument and additional information

(if any) concerning its locality are as follows: The Northeast corner of the claim is 2400' South and 440' West of the monument at the

Northeast Corner of Section 14, Township 5S, Range 25E

The above information is shown on the attached map.

DATED AND POSTED on the ground this 6 day of April, 2015.

LOCATOR(s)  AGENT

Print Name(s) Eptellus, Inc. - Daniel G. Francetic, RLS

Signature(s) *Daniel G. Francetic*

Form MCF100  
Revised July 2014

This form is available from the Arizona Geological Survey and may be reproduced.

AMC432124

# RED BULL - 365 CLAIM

## LOCATION OF RED BULL-361 THROUGH RED BULL-396 LODE CLAIMS

LOCATED IN SECTIONS 14 & 23, T.5S., R.25E.

GRAHAM COUNTY, ARIZONA

ALL CLAIMS ARE 1450' IN LENGTH AND 600' IN WIDTH UNLESS NOTED

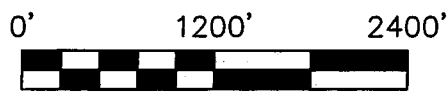
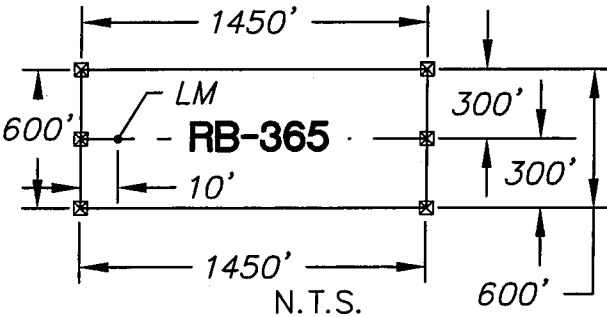
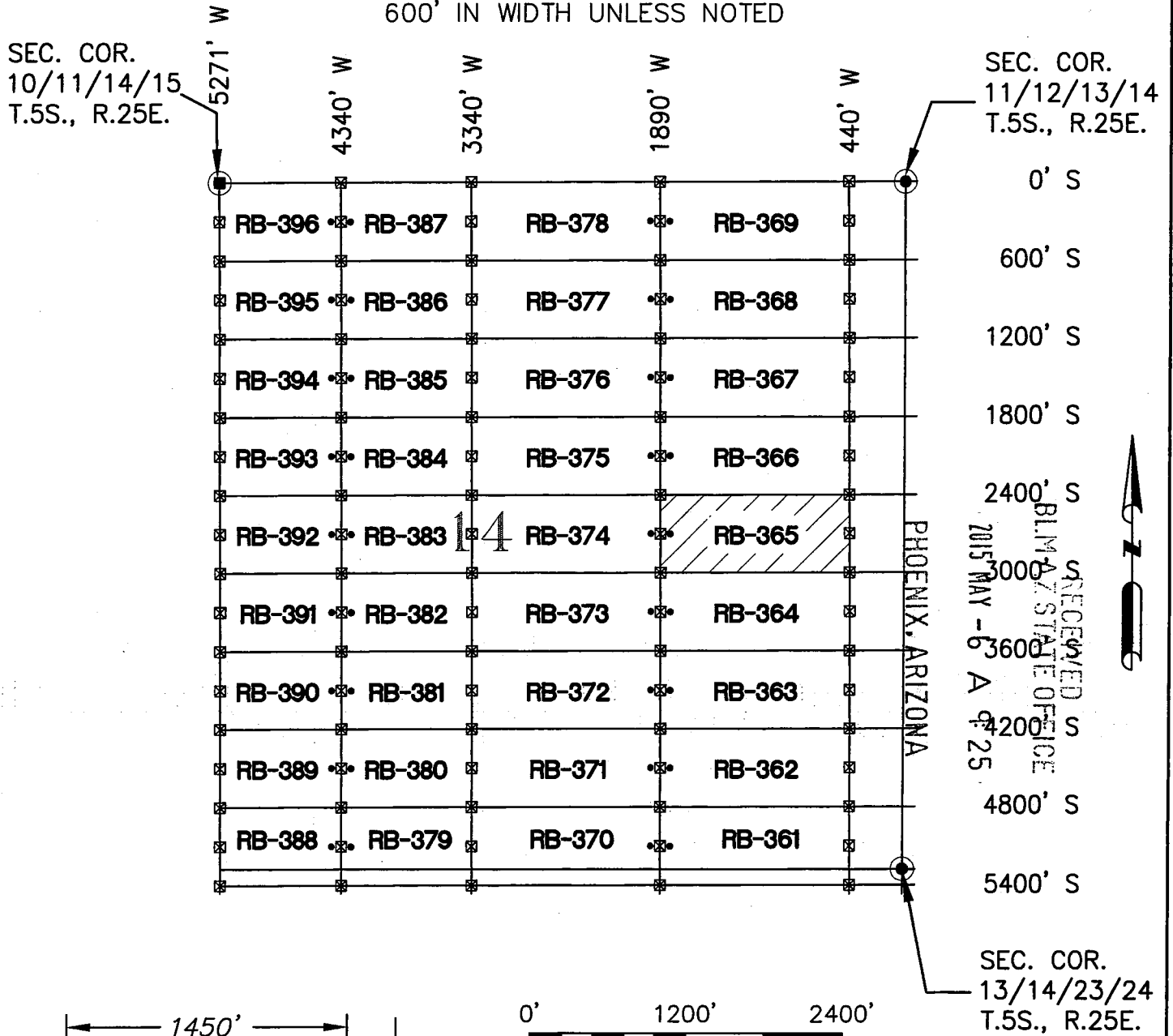

- ☒ INDICATES CORNER OF LODE CLAIM. SET 2"x2"x5' WOODEN POST (TYPICAL)
- INDICATES LOCATION MONUMENT. SET 2"x2"x5' WOODEN POST WITH SIGN (TYPICAL)

LOCATORS:  
 FREEPORT MINERALS CORP.  
 PO BOX 1019  
 SAFFORD AZ 85548

CLAIM ACREAGE = 20.0 AC  
 WC = WITNESS CORNER NORTH  
 OF SIDE LINE

**Entellus™**  
 2255 N. 44th Street Suite 125  
 Phoenix, AZ 85008.3279  
 Tel 602.244.2566  
 Fax 602.244.8947  
 Website: www.Entellus.com

**LOCATION NOTICE FOR LODE MINING CLAIM**

Amendment BLM Serial # \_\_\_\_\_

NOTICE IS HEREBY GIVEN that the Red Bull - 366

\_\_\_\_\_ lode mining claim has been located

by Freeport Minerals Corporation whose current mailing

address is P.O. Box 1019

Safford, Arizona 85548

RECEIVED  
BLM AZ STATE OFFICE  
2015 MAY -6 A 9: 25  
PHOENIX, ARIZONA  
BLM  
Date  
Stamp

The general course of this claim is East To West and it is situated in Graham

County, Arizona. This claim is 1450 feet in length and 600 feet in width.

20.0 Total Claim Acreage. This claim runs from the location monument on which this location notice

is posted on the centerline of the claim approximately 10 feet in a Westerly direction to the West

end line and 1440 feet in a Easterly direction to the East end line. This claim is marked by six

monuments, one at each corner and one at the center of each end line of the claim.

The location monument on which this notice is posted is situated within Section 14 Township 5

S, Range 25 E, Gila Salt River Base and Meridian, Arizona and this claim encompasses portions

of the following quarter section(s), section(s), Township(s) and Range(s) NE 1/4

Section 14 Township 5S Range 25E

Gila Salt River Base and Meridian, Arizona.

The locality of this claim with reference to some natural object or permanent monument and additional information

(if any) concerning its locality are as follows: The Northeast corner of the claim is 1800' South and 440' West of the monument at the

Northeast Corner of Section 14, Township 5S, Range 25E

The above information is shown on the attached map.

DATED AND POSTED on the ground this 6 day of April, 2015

LOCATOR(s)  AGENT

Print Name(s) Entellus, Inc. - Daniel G. Francetic, RLS

Signature(s) *Daniel G. Francetic*

Form MCF100  
Revised July 2014

AMC432125

# RED BULL - 366 CLAIM

## LOCATION OF RED BULL-361 THROUGH RED BULL-396 LODE CLAIMS

LOCATED IN SECTIONS 14 & 23, T.5S., R.25E.

GRAHAM COUNTY, ARIZONA

ALL CLAIMS ARE 1450' IN LENGTH AND 600' IN WIDTH UNLESS NOTED

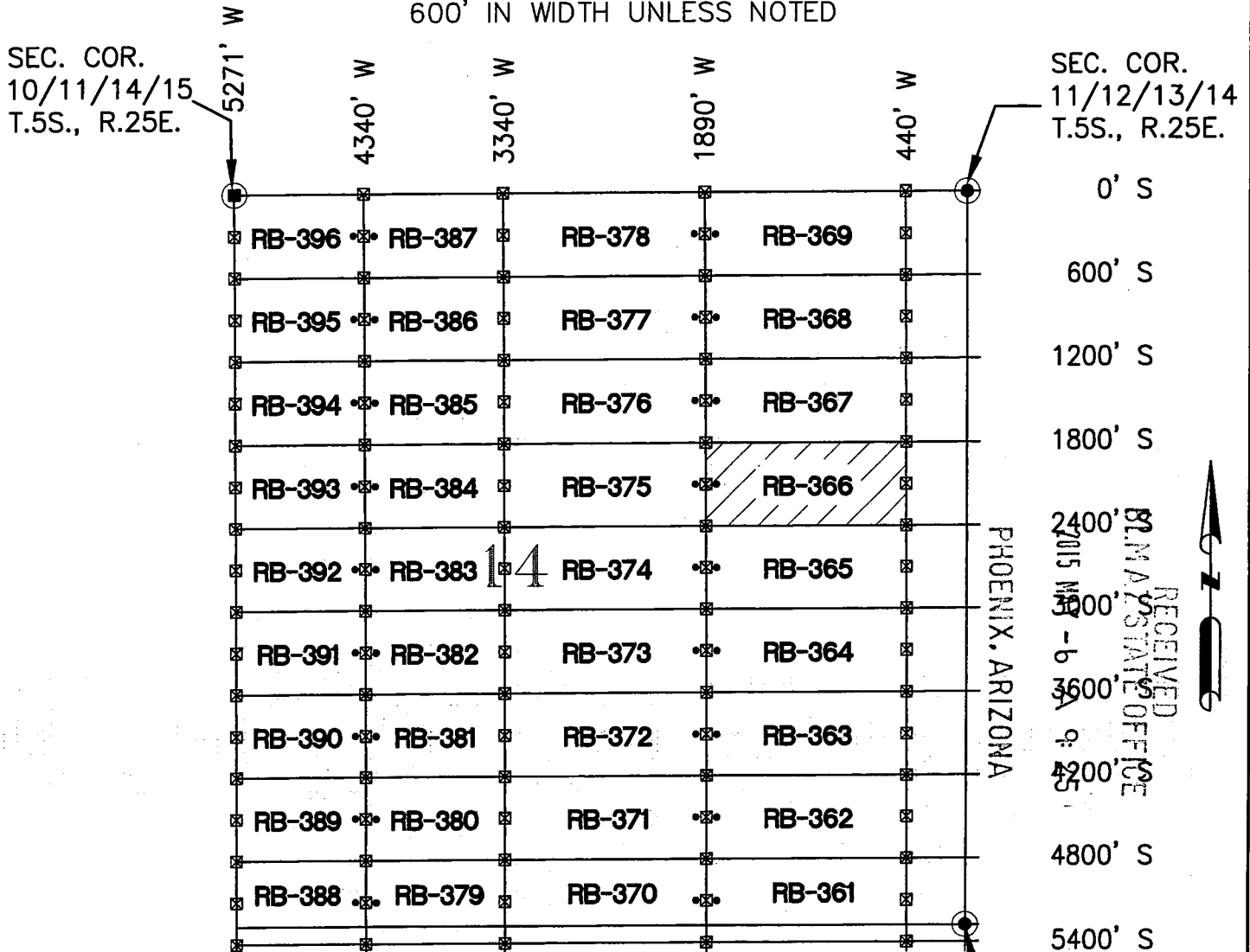

RECEIVED  
 BLM & STATE OFFICE  
 2015 MAR - 6  
 3600'

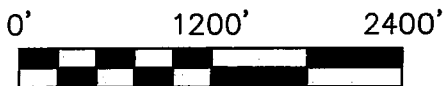
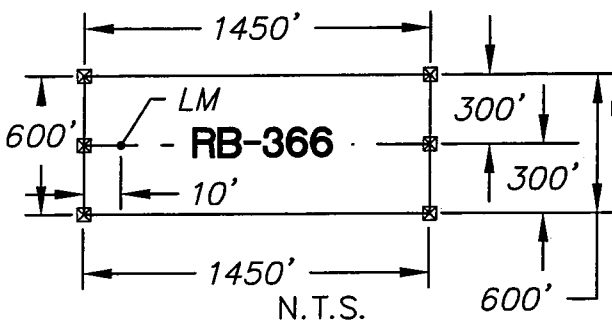

- ☒ INDICATES CORNER OF LODE CLAIM. SET 2"x2"x5' WOODEN POST (TYPICAL)
- INDICATES LOCATION MONUMENT. SET 2"x2"x5' WOODEN POST WITH SIGN (TYPICAL)

SEC. COR. 13/14/23/24 T.5S., R.25E.

LOCATORS:  
 FREEPORT MINERALS CORP.  
 PO BOX 1019  
 SAFFORD AZ 85548

CLAIM ACREAGE = 20.0 AC  
 WC = WITNESS CORNER NORTH OF SIDE LINE

**Entellus™**  
 2255 N. 44th Street Suite 125  
 Phoenix, AZ 85008.3279  
 Tel 602.244.2566  
 Fax 602.244.8947  
 Website: www.Entellus.com

**LOCATION NOTICE FOR LODE MINING CLAIM**

Amendment      BLM Serial # \_\_\_\_\_

NOTICE IS HEREBY GIVEN that the Red Bull - 367

\_\_\_\_\_ lode mining claim has been located

by Freeport Minerals Corporation whose current mailing

address is P.O. Box 1019

Safford, Arizona 85548

BLM  
Date  
Stamp

RECEIVED  
BLM AZ STATE OFFICE  
2015 MAY -6 A 9: 24  
PHOENIX, ARIZONA

The general course of this claim is East To West and it is situated in Graham

County, Arizona. This claim is 1450 feet in length and 600 feet in width.

20.0 Total Claim Acreage. This claim runs from the location monument on which this location notice

is posted on the centerline of the claim approximately 10 feet in a Westerly direction to the West

end line and 1440 feet in a Easterly direction to the East end line. This claim is marked by six

monuments, one at each corner and one at the center of each end line of the claim.

The location monument on which this notice is posted is situated within Section 14 Township 5

S, Range 25 E, Gila Salt River Base and Meridian, Arizona and this claim encompasses portions

of the following quarter section(s), section(s), Township(s) and Range(s) NE 1/4

Section 14 Township 5S Range 25E

Gila Salt River Base and Meridian, Arizona.

The locality of this claim with reference to some natural object or permanent monument and additional information

(if any) concerning its locality are as follows: The Northeast corner of the claim is 1200' South and 440' West of the monument at the

Northeast Corner of Section 14, Township 5S, Range 25E

The above information is shown on the attached map.

DATED AND POSTED on the ground this 6 day of April, 2015.

LOCATOR(s)       AGENT

Print Name(s) Entellus, Inc. - Daniel G. Francetic, RLS

Signature(s) *Daniel G. Francetic*

Form MCF100  
Revised July 2014

AMC432126



# RED BULL - 367 CLAIM

## LOCATION OF RED BULL-361 THROUGH RED BULL-396 LODE CLAIMS

LOCATED IN SECTIONS 14 & 23, T.5S., R.25E.

GRAHAM COUNTY, ARIZONA

ALL CLAIMS ARE 1450' IN LENGTH AND

600' IN WIDTH UNLESS NOTED

SEC. COR.  
10/11/14/15  
T.5S., R.25E.

SEC. COR.  
11/12/13/14  
T.5S., R.25E.

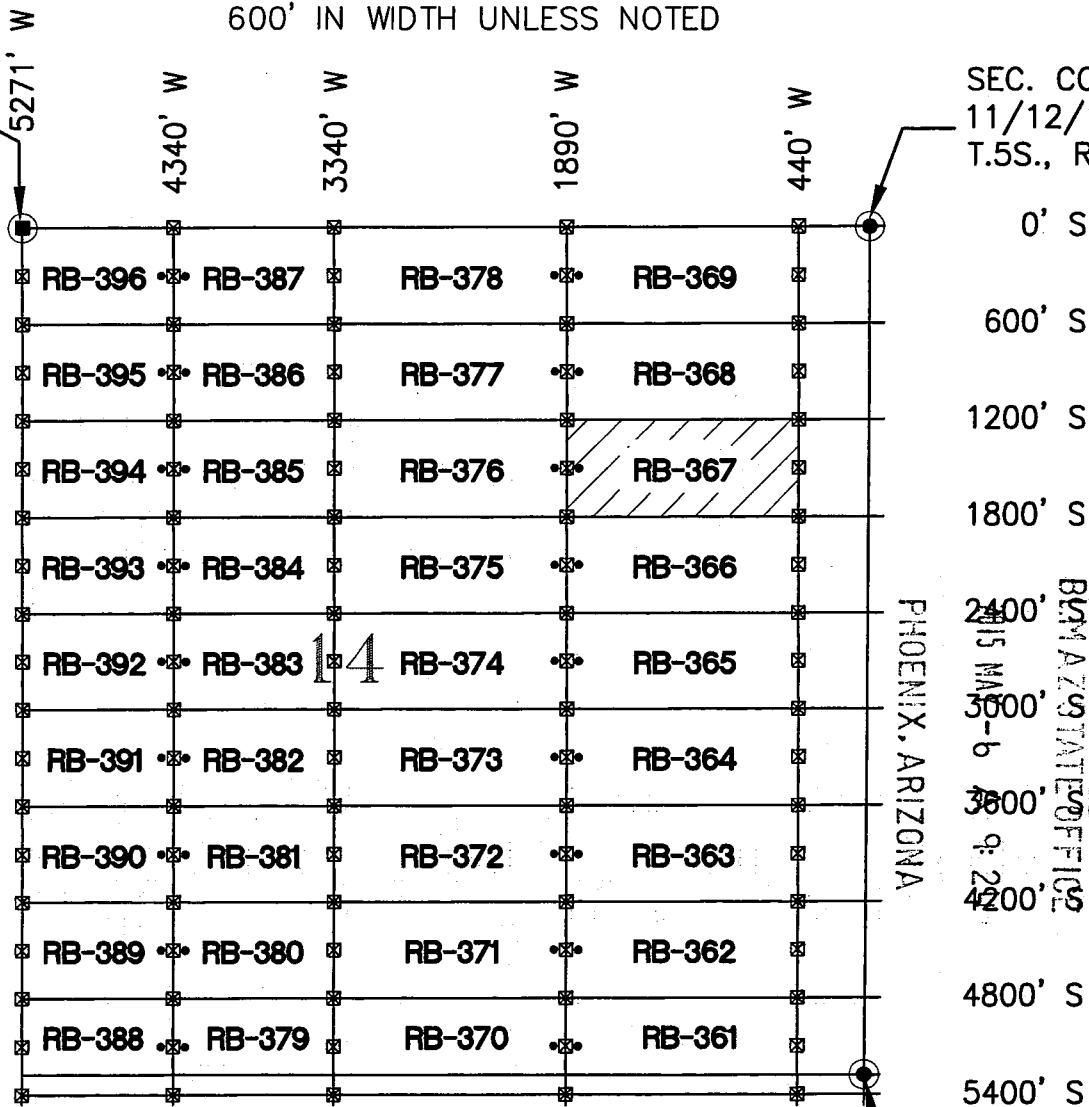

PHOENIX, ARIZONA

SEC. COR.  
13/14/23/24  
T.5S., R.25E.

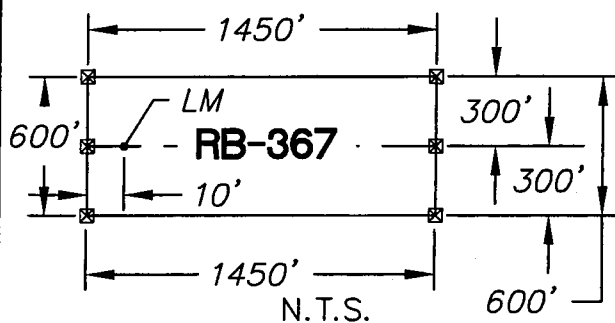

0' 1200' 2400'



☒ INDICATES CORNER OF LODE CLAIM.  
SET 2"x2"x5' WOODEN POST (TYPICAL)

• INDICATES LOCATION  
MONUMENT. SET 2"x2"x5'  
WOODEN POST WITH SIGN  
(TYPICAL)

LOCATORS:  
FREEPORT MINERALS CORP.  
PO BOX 1019  
SAFFORD AZ 85548

CLAIM ACREAGE = 20.0 AC  
WC = WITNESS CORNER NORTH  
OF SIDE LINE

 **Entellus™**  
2255 N. 44th Street Suite 125  
Phoenix, AZ 85008.3279  
Tel 602.244.2566  
Fax 602.244.8947  
Website: www.Entellus.com

**LOCATION NOTICE FOR LODE MINING CLAIM**

Amendment      BLM Serial # \_\_\_\_\_

NOTICE IS HEREBY GIVEN that the Red Bull - 368

\_\_\_\_\_ lode mining claim has been located

by Freeport Minerals Corporation whose current mailing

address is P.O. Box 1019

\_\_\_\_\_ Safford, Arizona 85548

The general course of this claim is East To West and it is situated in Graham

County, Arizona. This claim is 1450 feet in length and 600 feet in width.

20.0 Total Claim Acreage. This claim runs from the location monument on which this location notice

is posted on the centerline of the claim approximately 10 feet in a Westerly direction to the West

end line and 1440 feet in a Easterly direction to the East end line. This claim is marked by six

monuments, one at each corner and one at the center of each end line of the claim.

The location monument on which this notice is posted is situated within Section 14 Township 5

S, Range 25 E, Gila Salt River Base and Meridian, Arizona and this claim encompasses portions

of the following quarter section(s), section(s), Township(s) and Range(s) NE 1/4

Section 14 Township 5S Range 25E

Gila Salt River Base and Meridian, Arizona.

The locality of this claim with reference to some natural object or permanent monument and additional information

(if any) concerning its locality are as follows: The Northeast corner of the claim is 600' South and 440' West of the monument at the

Northeast Corner of Section 14, Township 5S, Range 25E

The above information is shown on the attached map.

DATED AND POSTED on the ground this 6 day of April, 2015.

LOCATOR(s)       AGENT

Print Name(s) Entellus, Inc. - Daniel G. Francetic, RLS

Signature(s) *Daniel G. Francetic*

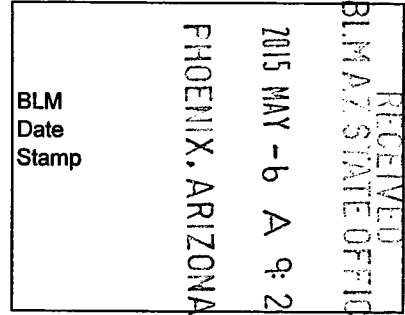

AMC432121

Form MCF100 Revised July 2014

# RED BULL - 368 CLAIM

## LOCATION OF RED BULL-361 THROUGH RED BULL-396 LODE CLAIMS

LOCATED IN SECTIONS 14 & 23, T.5S., R.25E.

GRAHAM COUNTY, ARIZONA

ALL CLAIMS ARE 1450' IN LENGTH AND

600' IN WIDTH UNLESS NOTED

SEC. COR.  
10/11/14/15  
T.5S., R.25E.

SEC. COR.  
11/12/13/14  
T.5S., R.25E.

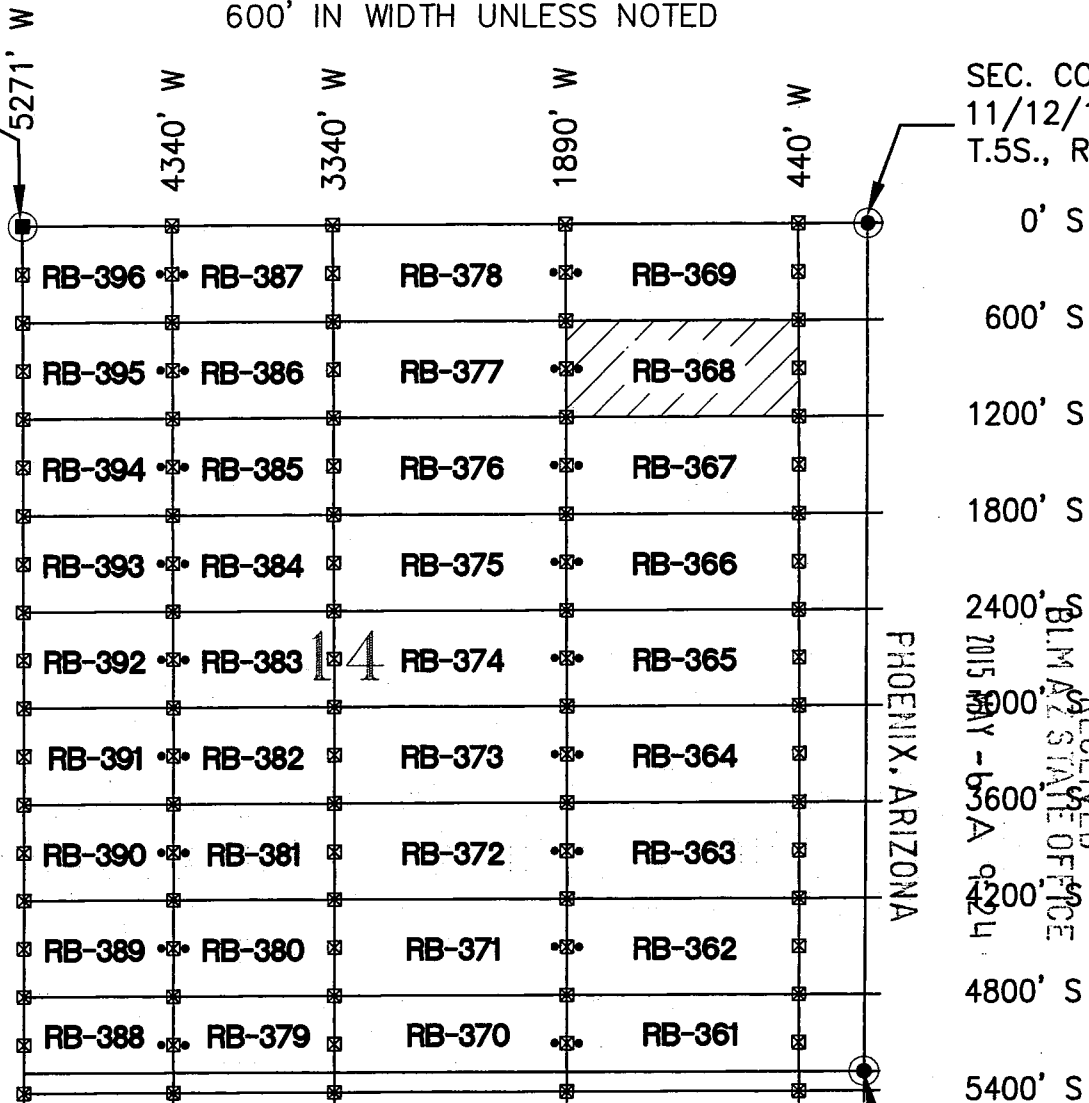

PHOENIX, ARIZONA

RECEIVED  
BLM AZ STATE OFFICE  
MAY - 6 2015



SEC. COR.  
13/14/23/24  
T.5S., R.25E.

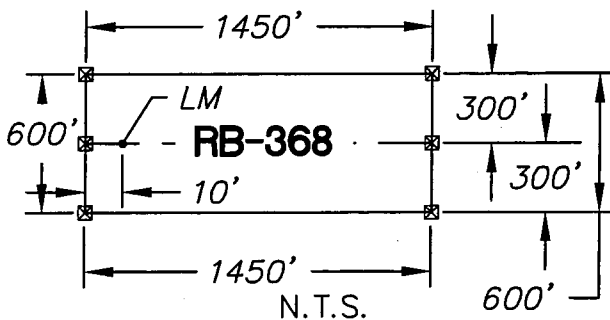

0'      1200'      2400'



☒ INDICATES CORNER OF LODE CLAIM.  
SET 2"x2"x5' WOODEN POST (TYPICAL)

• INDICATES LOCATION  
MONUMENT. SET 2"x2"x5'  
WOODEN POST WITH SIGN  
(TYPICAL)

LOCATORS:  
FREEPORT MINERALS CORP.  
PO BOX 1019  
SAFFORD AZ 85548

CLAIM ACREAGE = 20.0 AC  
WC = WITNESS CORNER NORTH  
OF SIDE LINE

 **Entellus™**  
2255 N. 44th Street Suite 125  
Phoenix, AZ 85008.3279  
Tel 602.244.2566  
Fax 602.244.8947  
Website: www.Entellus.com

**LOCATION NOTICE FOR LODE MINING CLAIM**

Amendment      BLM Serial # \_\_\_\_\_

NOTICE IS HEREBY GIVEN that the Red Bull - 369

\_\_\_\_\_ lode mining claim has been located

by Freeport Minerals Corporation whose current mailing

address is P.O. Box 1019

Safford, Arizona 85548

RECEIVED  
BLM AZ STATE OFFICE  
2015 MAY -6 A 9:24  
PHOENIX, ARIZONA  
BLM  
Date  
Stamp

The general course of this claim is East To West and it is situated in Graham

County, Arizona. This claim is 1450 feet in length and 600 feet in width.

20.0 Total Claim Acreage. This claim runs from the location monument on which this location notice

is posted on the centerline of the claim approximately 10 feet in a Westerly direction to the West

end line and 1440 feet in a Easterly direction to the East end line. This claim is marked by six

monuments, one at each corner and one at the center of each end line of the claim.

The location monument on which this notice is posted is situated within Section 14 Township 5

S, Range 25 E, Gila Salt River Base and Meridian, Arizona and this claim encompasses portions

of the following quarter section(s), section(s), Township(s) and Range(s) NE 1/4

Section 14 Township 5S Range 25E

Gila Salt River Base and Meridian, Arizona.

The locality of this claim with reference to some natural object or permanent monument and additional information

(if any) concerning its locality are as follows: The Northeast corner of the claim is 440' West of the monument at the

Northeast Corner of Section 14, Township 5S, Range 25E

The above information is shown on the attached map.

DATED AND POSTED on the ground this 6 day of April, 2015.

LOCATOR(s)       AGENT

Print Name(s) Entellus, Inc. - Daniel G. Francetic, RLS

Signature(s) *Daniel G. Francetic*

Form MCF100  
Revised July 2014

AMC432128

# RED BULL - 369 CLAIM

## LOCATION OF RED BULL-361 THROUGH RED BULL-396 LODE CLAIMS

LOCATED IN SECTIONS 14 & 23, T.5S., R.25E.

GRAHAM COUNTY, ARIZONA

ALL CLAIMS ARE 1450' IN LENGTH AND 600' IN WIDTH UNLESS NOTED

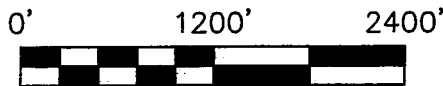
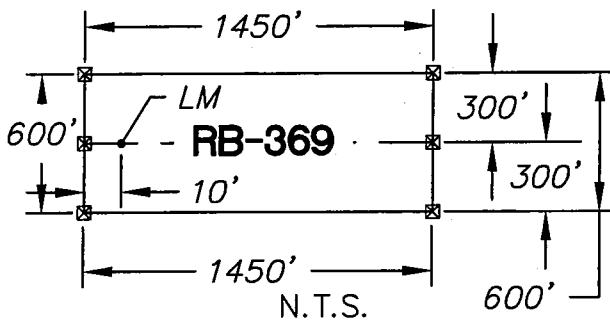
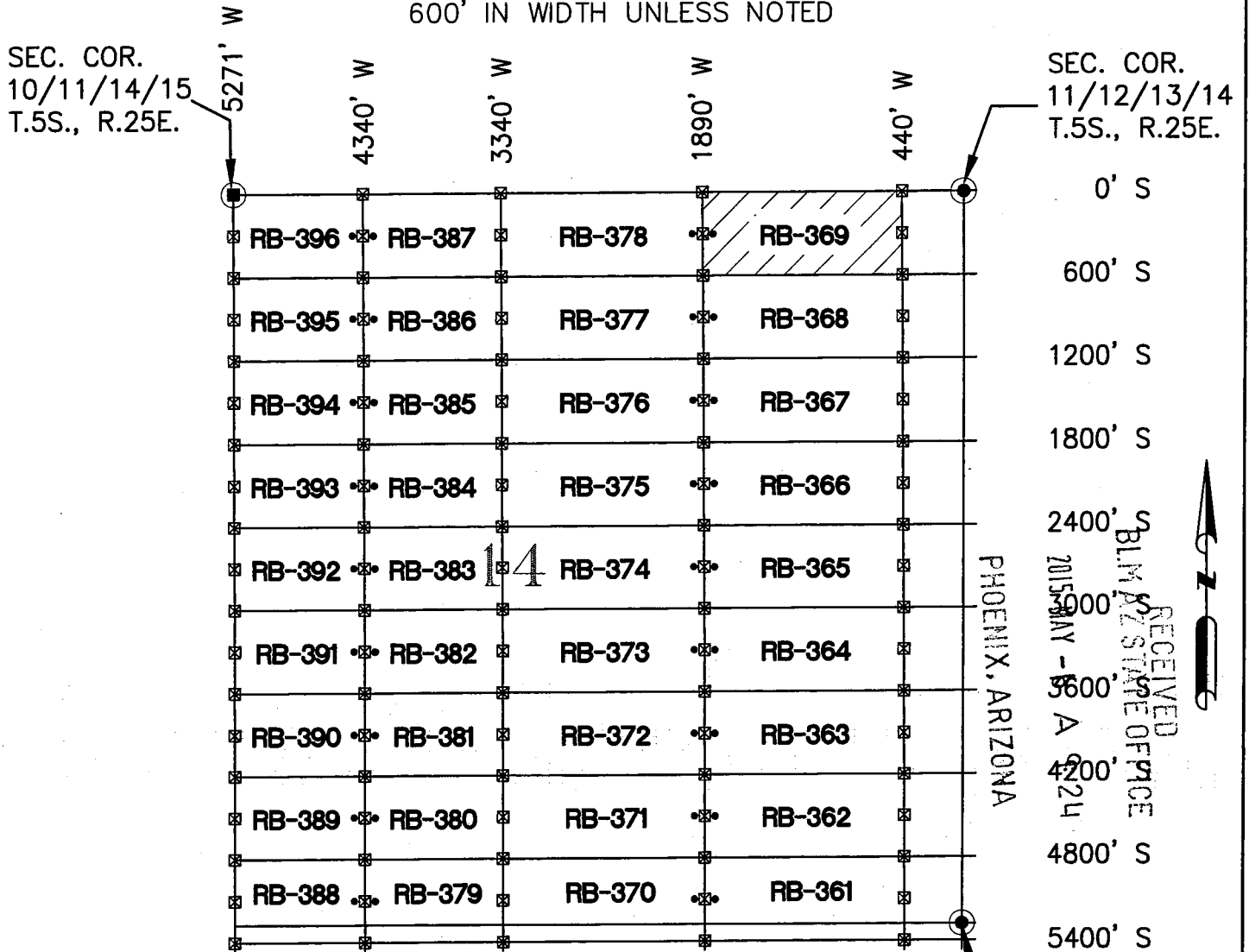

INDICATES CORNER OF LODE CLAIM.  
SET 2"x2"x5' WOODEN POST (TYPICAL)

INDICATES LOCATION  
MONUMENT. SET 2"x2"x5'  
WOODEN POST WITH SIGN  
(TYPICAL)

CLAIM ACREAGE = 20.0 AC

WC = WITNESS CORNER NORTH  
OF SIDE LINE

LOCATORS:  
FREEPORT MINERALS CORP.  
PO BOX 1019  
SAFFORD AZ 85548

 **Entellus™**  
2255 N. 44th Street Suite 125  
Phoenix, AZ 85008.3279  
Tel 602.244.2566  
Fax 602.244.8947  
Website: www.Entellus.com

LOCATION NOTICE FOR LODE MINING CLAIM

Amendment BLM Serial # \_\_\_\_\_

NOTICE IS HEREBY GIVEN that the Red Bull - 370

\_\_\_\_\_ lode mining claim has been located

by Freeport Minerals Corporation whose current mailing

address is P.O. Box 1019

Safford, Arizona 85548

BLM  
Date  
Stamp

RECEIVED  
BLM AZ STATE OFFICE  
2015 MAY -6 A 9:24  
PHOENIX, ARIZONA

The general course of this claim is East To West and it is situated in Graham

County, Arizona. This claim is 1450 feet in length and 600 feet in width.

20.0 Total Claim Acreage. This claim runs from the location monument on which this location notice

is posted on the centerline of the claim approximately 10 feet in a Easterly direction to the East

end line and 1440 feet in a Westerly direction to the West end line. This claim is marked by six

monuments, one at each corner and one at the center of each end line of the claim.

The location monument on which this notice is posted is situated within Section 14 Township 5

S, Range 25 E, Gila Salt River Base and Meridian, Arizona and this claim encompasses portions

of the following quarter section(s), section(s), Township(s) and Range(s) SE 1/4 and SW 1/4

Section 14 Township 5S Range 25E and NE 1/4 and NW 1/4 Section 23, Township 5S, Range 25E

Gila Salt River Base and Meridian, Arizona.

The locality of this claim with reference to some natural object or permanent monument and additional information

(if any) concerning its locality are as follows: The Northeast corner of the claim is 4800' South and 1890' West of the monument at the

Northeast Corner of Section 14, Township 5S, Range 25E

The above information is shown on the attached map.

DATED AND POSTED on the ground this 6 day of April, 2015

LOCATOR(s)  AGENT

Print Name(s) Entellus, Inc. - Daniel G. Francetic, RLS

Signature(s) *Daniel G. Francetic*

Form MCF100  
Revised July 2014

AMC 4321291

# RED BULL - 370 CLAIM

## LOCATION OF RED BULL-361 THROUGH RED BULL-396 LODE CLAIMS

LOCATED IN SECTIONS 14 & 23, T.5S., R.25E.

GRAHAM COUNTY, ARIZONA

ALL CLAIMS ARE 1450' IN LENGTH AND 600' IN WIDTH UNLESS NOTED

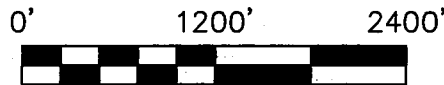
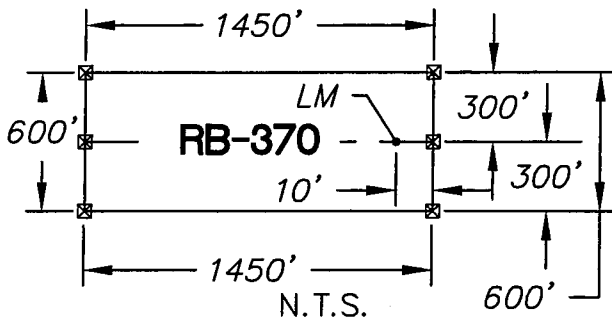
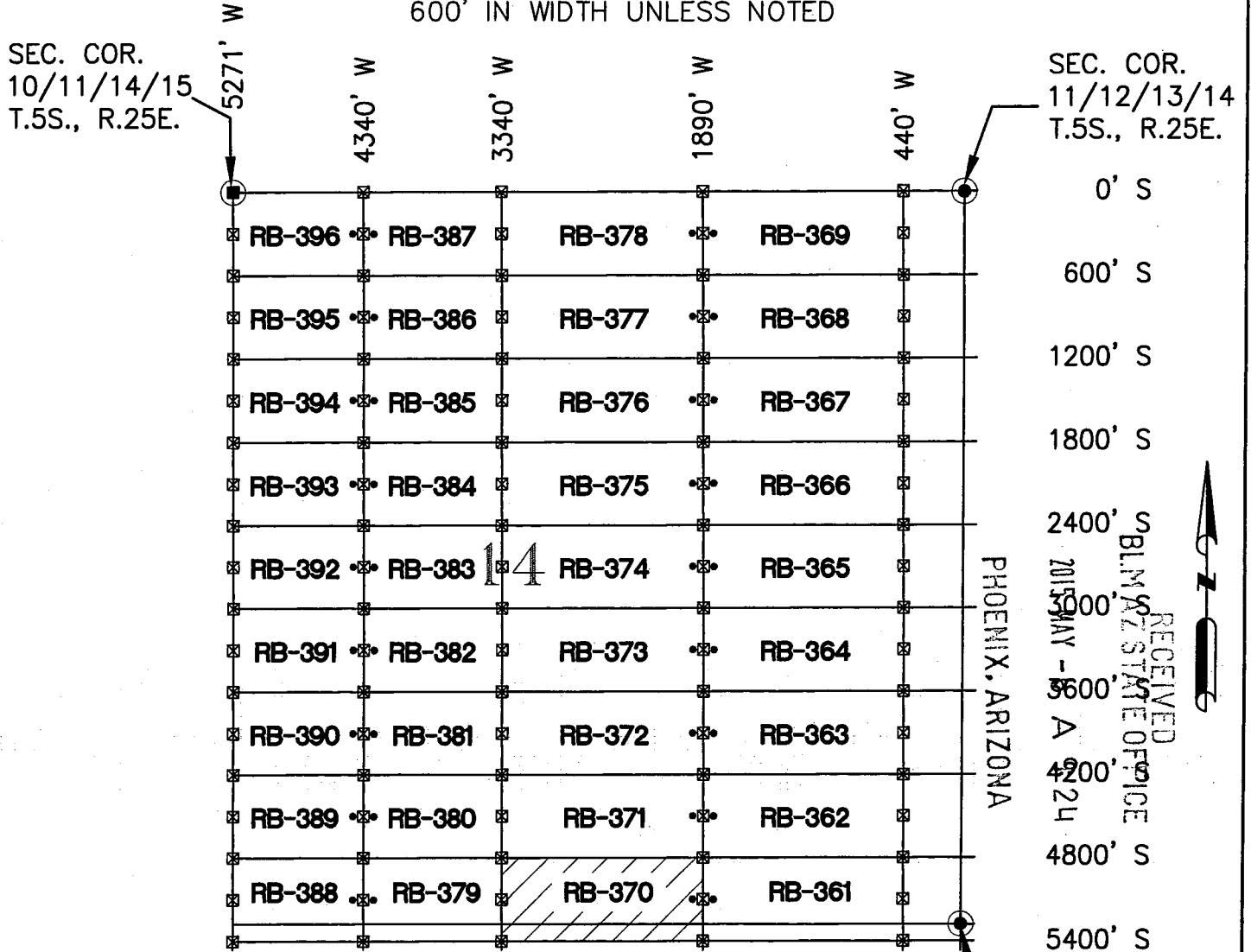

☒ INDICATES CORNER OF LODE CLAIM.  
SET 2"x2"x5' WOODEN POST (TYPICAL)

• INDICATES LOCATION  
MONUMENT. SET 2"x2"x5'  
WOODEN POST WITH SIGN  
(TYPICAL)

LOCATORS:  
FREEPORT MINERALS CORP.  
PO BOX 1019  
SAFFORD AZ 85548

CLAIM ACREAGE = 20.0 AC  
WC = WITNESS CORNER NORTH  
OF SIDE LINE

 **Entellus™**  
2255 N. 44th Street Suite 125  
Phoenix, AZ 85008.3279  
Tel 602.244.2566  
Fax 602.244.8947  
Website: www.Entellus.com

RECEIVED  
BLM STATE OFFICE  
PHOENIX, ARIZONA  
2015 MAY -6 A 9:24

LOCATION NOTICE FOR LODE MINING CLAIM

Amendment BLM Serial # \_\_\_\_\_

NOTICE IS HEREBY GIVEN that the Red Bull - 371

\_\_\_\_\_ lode mining claim has been located

by Freeport Minerals Corporation whose current mailing

address is P.O. Box 1019

Safford, Arizona 85548

BLM  
Date  
Stamp

The general course of this claim is East To West and it is situated in Graham

County, Arizona. This claim is 1450 feet in length and 600 feet in width.

20.0 Total Claim Acreage. This claim runs from the location monument on which this location notice

is posted on the centerline of the claim approximately 10 feet in a Easterly direction to the East

end line and 1440 feet in a Westerly direction to the West end line. This claim is marked by six

monuments, one at each corner and one at the center of each end line of the claim.

The location monument on which this notice is posted is situated within Section 14 Township 5

S, Range 25 E, Gila Salt River Base and Meridian, Arizona and this claim encompasses portions

of the following quarter section(s), section(s), Township(s) and Range(s) SE 1/4 and SW 1/4

Section 14 Township 5S Range 25E

Gila Salt River Base and Meridian, Arizona.

The locality of this claim with reference to some natural object or permanent monument and additional information

(if any) concerning its locality are as follows: The Northeast corner of the claim is 4200' South and 1890' West of the monument at the

Northeast Corner of Section 14, Township 5S, Range 25E

The above information is shown on the attached map.

DATED AND POSTED on the ground this 6 day of April, 2015.

LOCATOR(s)  AGENT

Print Name(s) Entellus, Inc. - Daniel G. Francetic, RLS

Signature(s) *Daniel G. Francetic*

Form MCF100  
Revised July 2014

AN0432130



# RED BULL - 371 CLAIM

LOCATION OF RED BULL-361 THROUGH RED BULL-396 LODE CLAIMS

LOCATED IN SECTIONS 14 & 23, T.5S., R.25E.

GRAHAM COUNTY, ARIZONA

ALL CLAIMS ARE 1450' IN LENGTH AND

600' IN WIDTH UNLESS NOTED

SEC. COR.  
10/11/14/15  
T.5S., R.25E.

SEC. COR.  
11/12/13/14  
T.5S., R.25E.

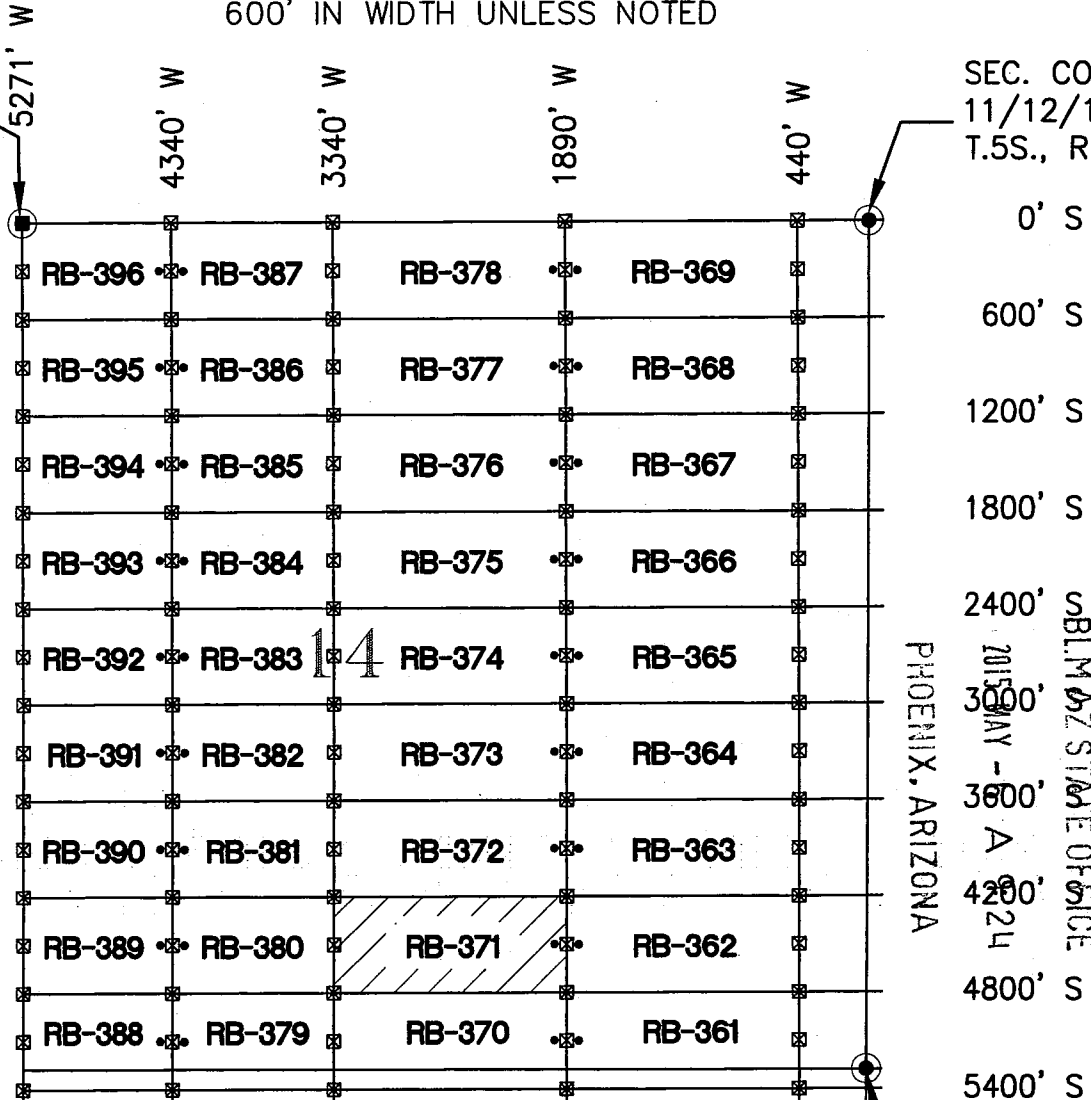

PHOENIX, ARIZONA

RECEIVED  
SBLM AZ STATE OFFICE  
MAY - 2010

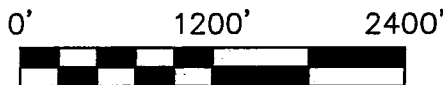
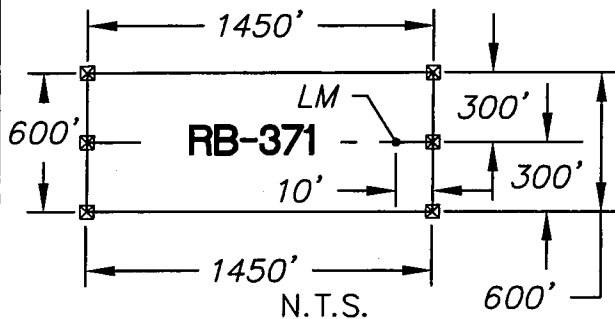

☒ INDICATES CORNER OF LODE CLAIM.  
SET 2"x2"x5' WOODEN POST (TYPICAL)

• INDICATES LOCATION  
MONUMENT. SET 2"x2"x5'  
WOODEN POST WITH SIGN  
(TYPICAL)

CLAIM ACREAGE = 20.0 AC

WC = WITNESS CORNER NORTH  
OF SIDE LINE

LOCATORS:  
FREEPORT MINERALS CORP.  
PO BOX 1019  
SAFFORD AZ 85548

**Entellus™**  
2255 N. 44th Street Suite 125  
Phoenix, AZ 85008.3279  
Tel 602.244.2566  
Fax 602.244.8947  
Website: www.Entellus.com

SEC. COR.  
13/14/23/24  
T.5S., R.25E.

LOCATION NOTICE FOR LODE MINING CLAIM

Amendment BLM Serial # \_\_\_\_\_

NOTICE IS HEREBY GIVEN that the Red Bull - 372

\_\_\_\_\_ lode mining claim has been located

by Freeport Minerals Corporation whose current mailing

address is P.O. Box 1019

Safford, Arizona 85548

BLM  
Date  
Stamp

RECEIVED  
BLM AZ STATE OFFICE  
2015 MAY - 6 A 9: 24  
PHOENIX, ARIZONA

The general course of this claim is East To West and it is situated in Graham

County, Arizona. This claim is 1450 feet in length and 600 feet in width.

20.0 Total Claim Acreage. This claim runs from the location monument on which this location notice

is posted on the centerline of the claim approximately 10 feet in a Easterly direction to the East

end line and 1440 feet in a Westerly direction to the West end line. This claim is marked by six

monuments, one at each corner and one at the center of each end line of the claim.

The location monument on which this notice is posted is situated within Section 14 Township 5

S, Range 25 E, Gila Salt River Base and Meridian, Arizona and this claim encompasses portions

of the following quarter section(s), section(s), Township(s) and Range(s) SE 1/4 and SW 1/4

Section 14 Township 5S Range 25E

Gila Salt River Base and Meridian, Arizona.

The locality of this claim with reference to some natural object or permanent monument and additional information

(if any) concerning its locality are as follows: The Northeast corner of the claim is 3600' South and 1890' West of the monument at the

Northeast Corner of Section 14, Township 5S, Range 25E

The above information is shown on the attached map.

DATED AND POSTED on the ground this 6 day of April, 2015

LOCATOR(s)  AGENT

Print Name(s) Entellus, Inc. - Daniel G. Francetic, RLS

Signature(s) *Daniel G. Francetic*

Form MCF100  
Revised July 2014

AMC 432131

# RED BULL - 372 CLAIM

LOCATION OF RED BULL-361 THROUGH RED BULL-396 LODE CLAIMS  
 LOCATED IN SECTIONS 14 & 23, T.5S., R.25E.  
 GRAHAM COUNTY, ARIZONA  
 ALL CLAIMS ARE 1450' IN LENGTH AND  
 600' IN WIDTH UNLESS NOTED

SEC. COR.  
 10/11/14/15  
 T.5S., R.25E.

SEC. COR.  
 11/12/13/14  
 T.5S., R.25E.

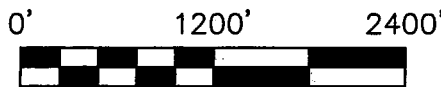
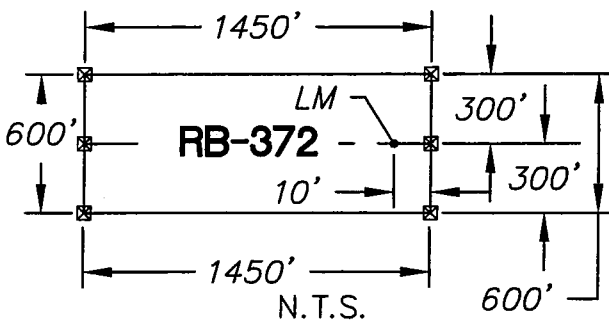
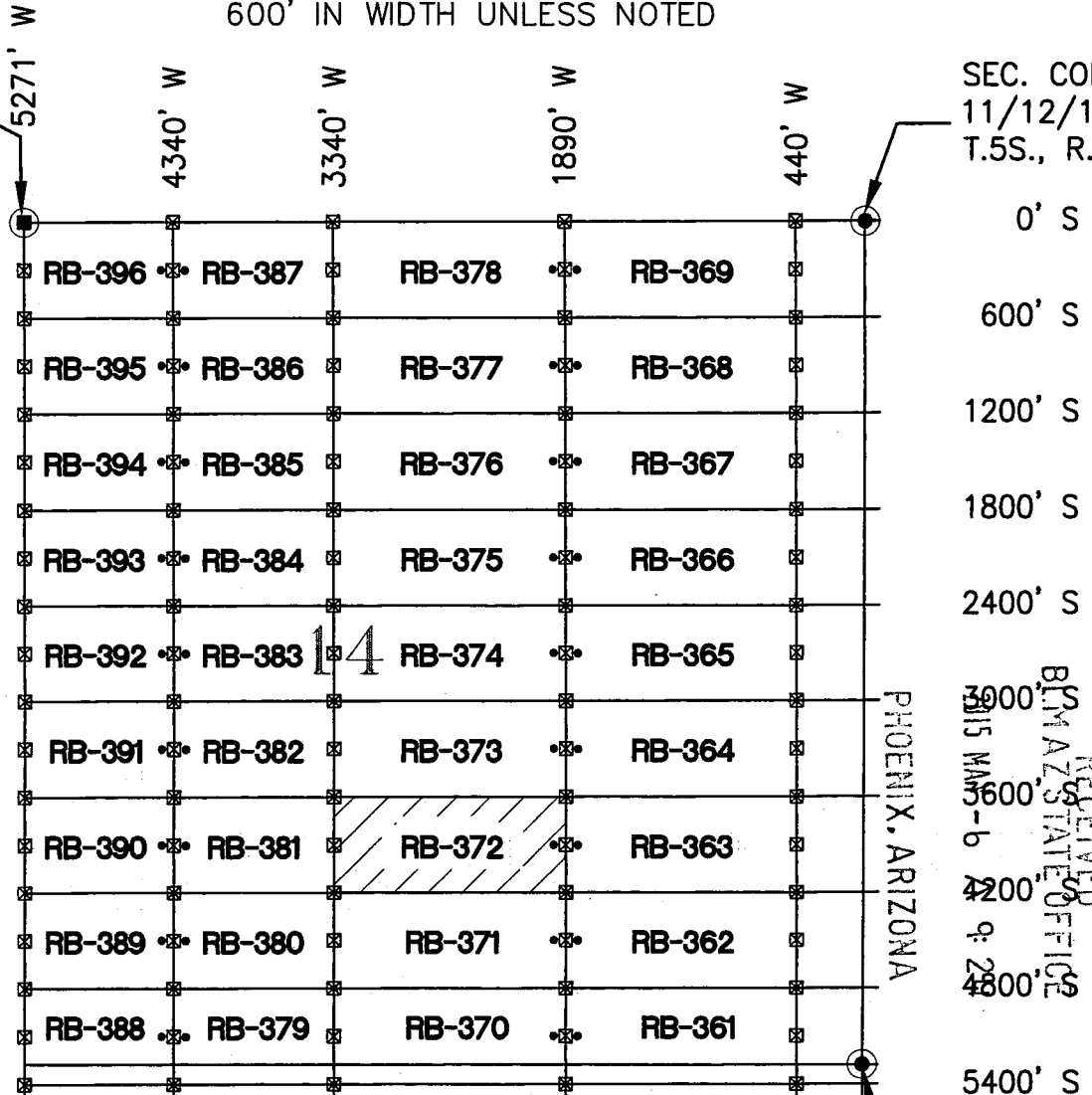

- ☒ INDICATES CORNER OF LODE CLAIM. SET 2"x2"x5' WOODEN POST (TYPICAL)
- INDICATES LOCATION MONUMENT. SET 2"x2"x5' WOODEN POST WITH SIGN (TYPICAL)

LOCATORS:  
 FREEPORT MINERALS CORP.  
 PO BOX 1019  
 SAFFORD AZ 85548

CLAIM ACREAGE = 20.0 AC  
 WC = WITNESS CORNER NORTH  
 OF SIDE LINE

 **Entellus™**  
 2255 N. 44th Street Suite 125  
 Phoenix, AZ 85008.3279  
 Tel 602.244.2566  
 Fax 602.244.8947  
 Website: www.Entellus.com

LOCATION NOTICE FOR LODE MINING CLAIM

Amendment BLM Serial # \_\_\_\_\_

NOTICE IS HEREBY GIVEN that the Red Bull - 373

\_\_\_\_\_ lode mining claim has been located  
by Freeport Minerals Corporation whose current mailing  
address is P.O. Box 1019  
Safford, Arizona 85548

RECEIVED  
BLM AZ STATE OFFICE  
2015 MAY -6 A 9:24  
PHOENIX, ARIZONA  
BLM  
Date  
Stamp

The general course of this claim is East To West and it is situated in Graham  
County, Arizona. This claim is 1450 feet in length and 600 feet in width.

20.0 Total Claim Acreage. This claim runs from the location monument on which this location notice  
is posted on the centerline of the claim approximately 10 feet in a Easterly direction to the East  
end line and 1440 feet in a Westerly direction to the West end line. This claim is marked by six  
monuments, one at each corner and one at the center of each end line of the claim.

The location monument on which this notice is posted is situated within Section 14 Township 5  
S, Range 25 E, Gila Salt River Base and Meridian, Arizona and this claim encompasses portions  
of the following quarter section(s), section(s), Township(s) and Range(s) SE 1/4 and SW 1/4

Section 14 Township 5S Range 25E

Gila Salt River Base and Meridian, Arizona.

The locality of this claim with reference to some natural object or permanent monument and additional information  
(if any) concerning its locality are as follows: The Northeast corner of the claim is 3000' South and 1890' West of the monument at the  
Northeast Corner of Section 14, Township 5S, Range 25E

The above information is shown on the attached map.

DATED AND POSTED on the ground this 6 day of April, 2015

LOCATOR(s)  AGENT

Print Name(s) Entellus, Inc. - Daniel G. Francetic, RLS

Signature(s) *Daniel G. Francetic*

Form MCF100  
Revised July 2014

AMC4321321

# RED BULL - 373 CLAIM

## LOCATION OF RED BULL-361 THROUGH RED BULL-396 LODE CLAIMS

LOCATED IN SECTIONS 14 & 23, T.5S., R.25E.

GRAHAM COUNTY, ARIZONA

ALL CLAIMS ARE 1450' IN LENGTH AND 600' IN WIDTH UNLESS NOTED

SEC. COR.  
10/11/14/15  
T.5S., R.25E.

SEC. COR.  
11/12/13/14  
T.5S., R.25E.

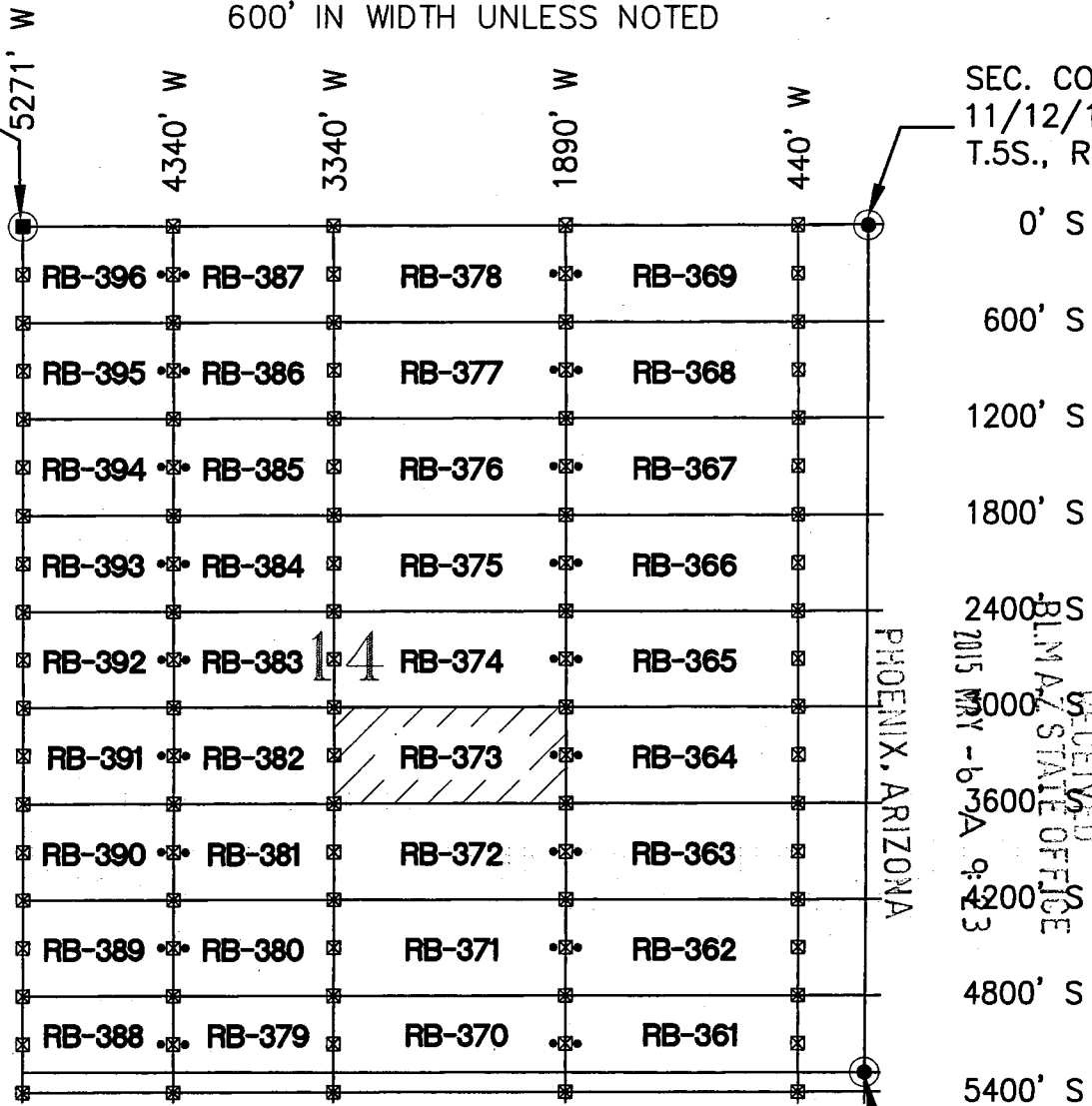

PHOENIX, ARIZONA

RECEIVED  
BLM AZ STATE OFFICE  
2015 MAR - 6 3 2015  
9:2003

SEC. COR.  
13/14/23/24  
T.5S., R.25E.

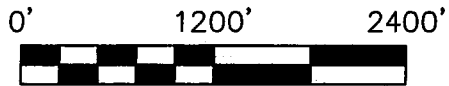
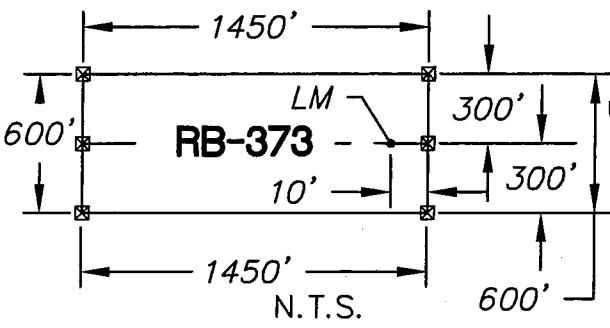

- ☒ INDICATES CORNER OF LODE CLAIM. SET 2"x2"x5' WOODEN POST (TYPICAL)
- INDICATES LOCATION MONUMENT. SET 2"x2"x5' WOODEN POST WITH SIGN (TYPICAL)

LOCATORS:  
FREEPORT MINERALS CORP.  
PO BOX 1019  
SAFFORD AZ 85548

CLAIM ACREAGE = 20.0 AC  
WC = WITNESS CORNER NORTH  
OF SIDE LINE

**Entellus™**  
2255 N. 44th Street Suite 125  
Phoenix, AZ 85008.3279  
Tel 602.244.2566  
Fax 602.244.8947  
Website: www.Entellus.com

LOCATION NOTICE FOR LODE MINING CLAIM

Amendment BLM Serial # \_\_\_\_\_

NOTICE IS HEREBY GIVEN that the Red Bull - 374

\_\_\_\_\_ lode mining claim has been located

by Freeport Minerals Corporation whose current mailing

address is P.O. Box 1019

Safford, Arizona 85548

RECEIVED  
BLM AZ STATE OFFICE  
2015 MAY -6 A 9:23  
PHOENIX, ARIZONA  
BLM  
Date  
Stamp

The general course of this claim is East To West and it is situated in Graham

County, Arizona. This claim is 1450 feet in length and 600 feet in width.

20.0 Total Claim Acreage. This claim runs from the location monument on which this location notice

is posted on the centerline of the claim approximately 10 feet in a Easterly direction to the East

end line and 1440 feet in a Westerly direction to the West end line. This claim is marked by six

monuments, one at each corner and one at the center of each end line of the claim.

The location monument on which this notice is posted is situated within Section 14 Township 5

S, Range 25 E, Gila Salt River Base and Meridian, Arizona and this claim encompasses portions

of the following quarter section(s), section(s), Township(s) and Range(s) SE 1/4, SW 1/4, NE 1/4 and NW 1/4

Section 14 Township 5S Range 25E

Gila Salt River Base and Meridian, Arizona.

The locality of this claim with reference to some natural object or permanent monument and additional information

(if any) concerning its locality are as follows: The Northeast corner of the claim is 2400' South and 1890' West of the monument at the

Northeast Corner of Section 14, Township 5S, Range 25E

The above information is shown on the attached map.

DATED AND POSTED on the ground this 6 day of April, 2015.

LOCATOR(s)  AGENT

Print Name(s) Entellus, Inc. - Daniel G. Francetic, RLS

Signature(s) *Daniel G. Francetic*

Form MCF100  
Revised July 2014

AMC4321331

# RED BULL - 374 CLAIM

LOCATION OF RED BULL-361 THROUGH RED BULL-396 LOSE CLAIMS  
 LOCATED IN SECTIONS 14 & 23, T.5S., R.25E.  
 GRAHAM COUNTY, ARIZONA  
 ALL CLAIMS ARE 1450' IN LENGTH AND  
 600' IN WIDTH UNLESS NOTED

SEC. COR.  
 10/11/14/15  
 T.5S., R.25E.

SEC. COR.  
 11/12/13/14  
 T.5S., R.25E.

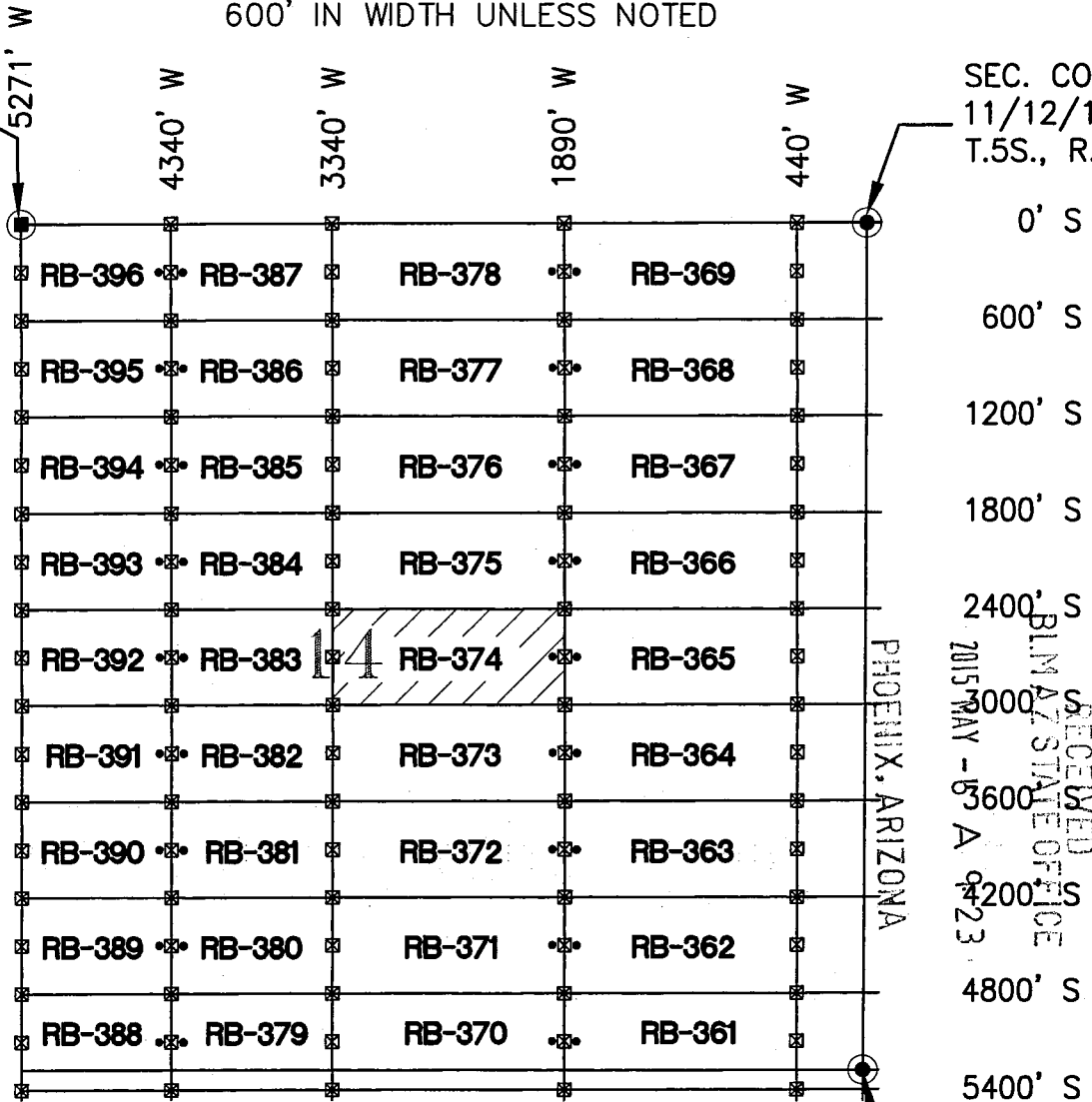

PHOENIX, ARIZONA

RECEIVED  
 BLM AZ STATE OFFICE  
 2015 MAY - 15 A  
 2015 MAY - 15 A  
 2015 MAY - 15 A

SEC. COR.  
 13/14/23/24  
 T.5S., R.25E.

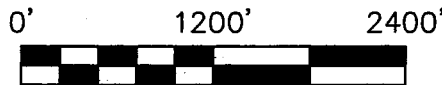
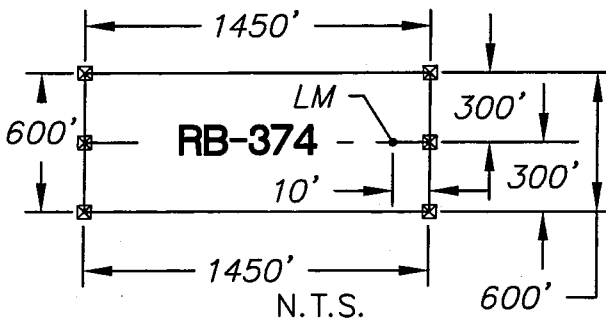

- ☒ INDICATES CORNER OF LOSE CLAIM.  
SET 2"x2"x5' WOODEN POST (TYPICAL)
- INDICATES LOCATION  
MONUMENT. SET 2"x2"x5'  
WOODEN POST WITH SIGN  
(TYPICAL)

LOCATORS:  
 FREEPORT MINERALS CORP.  
 PO BOX 1019  
 SAFFORD AZ 85548

CLAIM ACREAGE = 20.0 AC  
 WC = WITNESS CORNER NORTH  
 OF SIDE LINE

 **Entellus™**  
 2255 N. 44th Street Suite 125  
 Phoenix, AZ 85008.3279  
 Tel 602.244.2566  
 Fax 602.244.8947  
 Website: www.Entellus.com

LOCATION NOTICE FOR LODE MINING CLAIM

Amendment BLM Serial # \_\_\_\_\_

NOTICE IS HEREBY GIVEN that the Red Bull - 375

\_\_\_\_\_ lode mining claim has been located

by Freeport Minerals Corporation whose current mailing

address is P.O. Box 1019

Safford, Arizona 85548

BLM  
Date  
Stamp

RECEIVED  
BLM-AZ STATE OFFICE  
2015 MAY -6 A 9:23  
PHOENIX, ARIZONA

The general course of this claim is East To West and it is situated in Graham

County, Arizona. This claim is 1450 feet in length and 600 feet in width.

20.0 Total Claim Acreage. This claim runs from the location monument on which this location notice

is posted on the centerline of the claim approximately 10 feet in a Easterly direction to the East

end line and 1440 feet in a Westerly direction to the West end line. This claim is marked by six

monuments, one at each corner and one at the center of each end line of the claim.

The location monument on which this notice is posted is situated within Section 14 Township 5

S, Range 25 E, Gila Salt River Base and Meridian, Arizona and this claim encompasses portions

of the following quarter section(s), section(s), Township(s) and Range(s) NE 1/4 and NW 1/4

Section 14 Township 5S Range 25E

Gila Salt River Base and Meridian, Arizona.

The locality of this claim with reference to some natural object or permanent monument and additional information

(if any) concerning its locality are as follows: The Northeast corner of the claim is 1800' South and 1890' West of the monument at the

Northeast Corner of Section 14, Township 5S, Range 25E

The above information is shown on the attached map.

DATED AND POSTED on the ground this 6 day of April, 2015.

LOCATOR(s)  AGENT

Print Name(s) Entellus, Inc. - Daniel G. Francetic, RLS

Signature(s) *Daniel G. Francetic*

Form MCF100  
Revised July 2014

This form is available from the Arizona Geological Survey and may be reproduced.

AMC432134



# RED BULL - 375 CLAIM

## LOCATION OF RED BULL-361 THROUGH RED BULL-396 LODE CLAIMS

LOCATED IN SECTIONS 14 & 23, T.5S., R.25E.

GRAHAM COUNTY, ARIZONA

ALL CLAIMS ARE 1450' IN LENGTH AND 600' IN WIDTH UNLESS NOTED

SEC. COR.  
10/11/14/15  
T.5S., R.25E.

SEC. COR.  
11/12/13/14  
T.5S., R.25E.

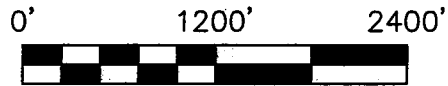
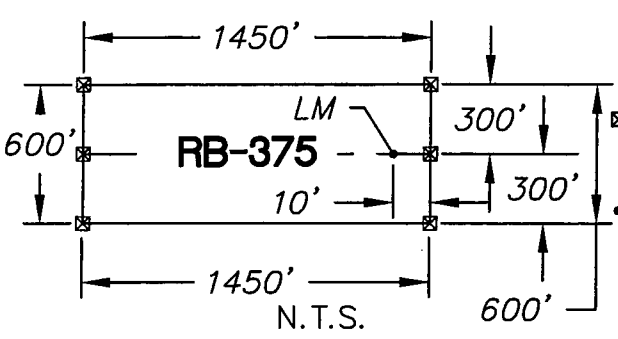
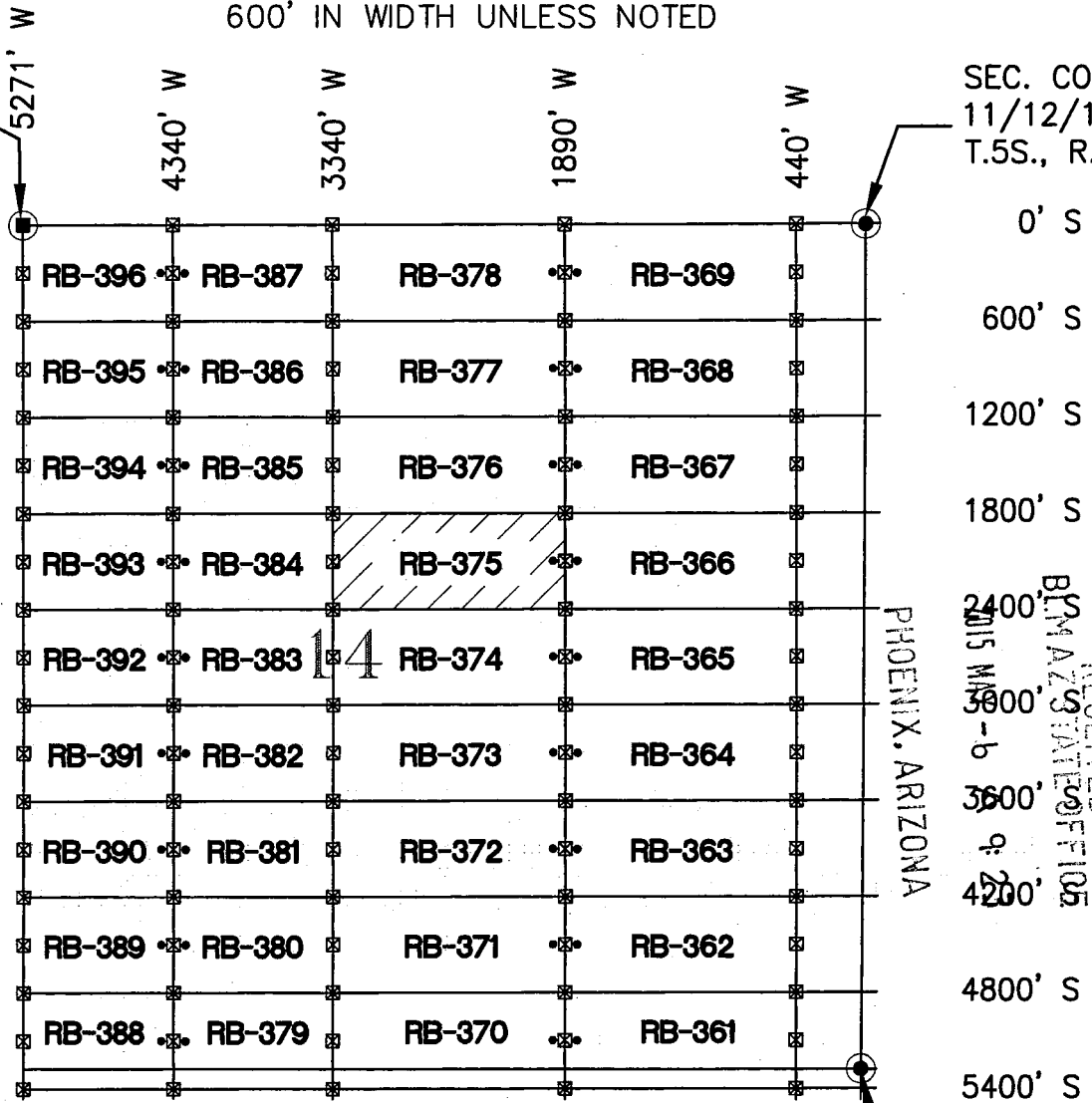

- ☒ INDICATES CORNER OF LODE CLAIM. SET 2"x2"x5' WOODEN POST (TYPICAL)
- INDICATES LOCATION MONUMENT. SET 2"x2"x5' WOODEN POST WITH SIGN (TYPICAL)

LOCATORS:  
FREEPORT MINERALS CORP.  
PO BOX 1019  
SAFFORD AZ 85548

CLAIM ACREAGE = 20.0 AC  
WC = WITNESS CORNER NORTH  
OF SIDE LINE

**Entellus™**  
2255 N. 44th Street Suite 125  
Phoenix, AZ 85008.3279  
Tel 602.244.2566  
Fax 602.244.8947  
Website: www.Entellus.com

LOCATION NOTICE FOR LODE MINING CLAIM

Amendment BLM Serial # \_\_\_\_\_

NOTICE IS HEREBY GIVEN that the Red Bull - 376

\_\_\_\_\_ lode mining claim has been located

by Freeport Minerals Corporation whose current mailing

address is P.O. Box 1019

Safford, Arizona 85548

RECEIVED  
BLM AZ STATE OFFICE  
2015 MAY -6 A 9:23  
PHOENIX, ARIZONA

BLM  
Date  
Stamp

The general course of this claim is East To West and it is situated in Graham

County, Arizona. This claim is 1450 feet in length and 600 feet in width.

20.0 Total Claim Acreage. This claim runs from the location monument on which this location notice

is posted on the centerline of the claim approximately 10 feet in a Easterly direction to the East

end line and 1440 feet in a Westerly direction to the West end line. This claim is marked by six

monuments, one at each corner and one at the center of each end line of the claim.

The location monument on which this notice is posted is situated within Section 14 Township 5

S, Range 25 E, Gila Salt River Base and Meridian, Arizona and this claim encompasses portions

of the following quarter section(s), section(s), Township(s) and Range(s) NE 1/4 and NW 1/4

Section 14 Township 5S Range 25E

Gila Salt River Base and Meridian, Arizona.

The locality of this claim with reference to some natural object or permanent monument and additional information

(if any) concerning its locality are as follows: The Northeast corner of the claim is 1200' South and 1890' West of the monument at the

Northeast Corner of Section 14, Township 5S, Range 25E

The above information is shown on the attached map.

DATED AND POSTED on the ground this 6 day of April, 2015.

LOCATOR(s)  AGENT

Print Name(s) Entellus, Inc. - Daniel G. Francetic, RLS

Signature(s) *Daniel G. Francetic*

Form MCF100  
Revised July 2014

AMC 432135

# RED BULL - 376 CLAIM

## LOCATION OF RED BULL-361 THROUGH RED BULL-396 LODE CLAIMS

LOCATED IN SECTIONS 14 & 23, T.5S., R.25E.

GRAHAM COUNTY, ARIZONA

ALL CLAIMS ARE 1450' IN LENGTH AND

600' IN WIDTH UNLESS NOTED

SEC. COR.  
10/11/14/15  
T.5S., R.25E.

SEC. COR.  
11/12/13/14  
T.5S., R.25E.

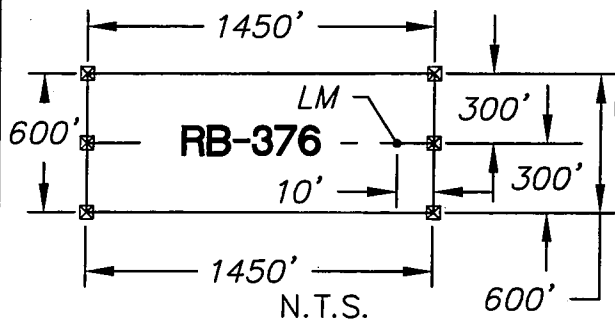
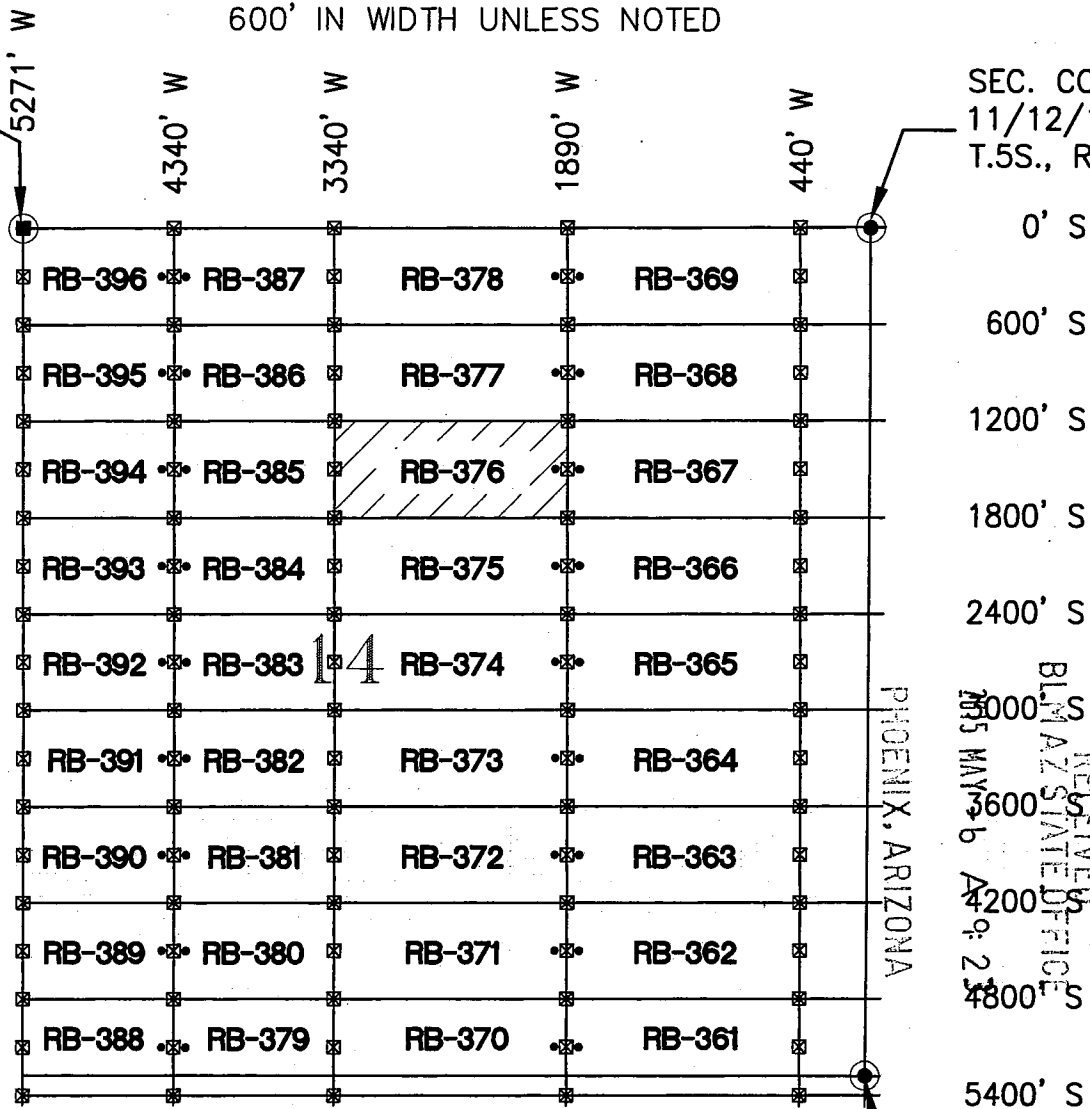

0' 1200' 2400'



- ☒ INDICATES CORNER OF LODE CLAIM. SET 2"x2"x5' WOODEN POST (TYPICAL)
- INDICATES LOCATION MONUMENT. SET 2"x2"x5' WOODEN POST WITH SIGN (TYPICAL)

LOCATORS:  
FREEPORT MINERALS CORP.  
PO BOX 1019  
SAFFORD AZ 85548

CLAIM ACREAGE = 20.0 AC  
WC = WITNESS CORNER NORTH  
OF SIDE LINE

 **Entellus™**  
2255 N. 44th Street Suite 125  
Phoenix, AZ 85008.3279  
Tel 602.244.2566  
Fax 602.244.8947  
Website: www.Entellus.com

LOCATION NOTICE FOR LODE MINING CLAIM

Amendment BLM Serial # \_\_\_\_\_

NOTICE IS HEREBY GIVEN that the Red Bull - 377

\_\_\_\_\_ lode mining claim has been located  
by Freeport Minerals Corporation whose current mailing  
address is P.O. Box 1019  
Safford, Arizona 85548

RECEIVED  
BLM AZ STATE OFFICE  
2015 MAY -6 A 9:23  
PHOENIX, ARIZONA  
BLM  
Date  
Stamp

The general course of this claim is East To West and it is situated in Graham  
County, Arizona. This claim is 1450 feet in length and 600 feet in width.

20.0 Total Claim Acreage. This claim runs from the location monument on which this location notice  
is posted on the centerline of the claim approximately 10 feet in a Easterly direction to the East  
end line and 1440 feet in a Westerly direction to the West end line. This claim is marked by six  
monuments, one at each corner and one at the center of each end line of the claim.

The location monument on which this notice is posted is situated within Section 14 Township 5  
S, Range 25 E, Gila Salt River Base and Meridian, Arizona and this claim encompasses portions  
of the following quarter section(s), section(s), Township(s) and Range(s) NE 1/4 and NW 1/4  
Section 14 Township 5S Range 25E

Gila Salt River Base and Meridian, Arizona.

The locality of this claim with reference to some natural object or permanent monument and additional information  
(if any) concerning its locality are as follows: The Northeast corner of the claim is 600' South and 1890' West of the monument at the  
Northeast Corner of Section 14, Township 5S, Range 25E

The above information is shown on the attached map.

DATED AND POSTED on the ground this 6 day of April, 2015

LOCATOR(s)  AGENT

Print Name(s) Entellus, Inc. - Daniel G. Francetic, RLS

Signature(s) *Daniel G. Francetic*

Form MCF100  
Revised July 2014

AMC 432136

# RED BULL - 377 CLAIM

## LOCATION OF RED BULL-361 THROUGH RED BULL-396 LODE CLAIMS

LOCATED IN SECTIONS 14 & 23, T.5S., R.25E.

GRAHAM COUNTY, ARIZONA

ALL CLAIMS ARE 1450' IN LENGTH AND  
600' IN WIDTH UNLESS NOTED

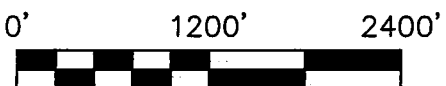
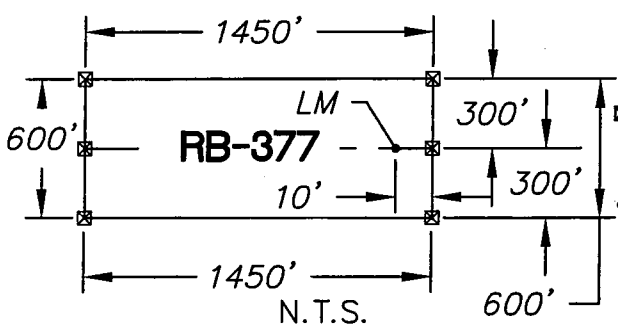
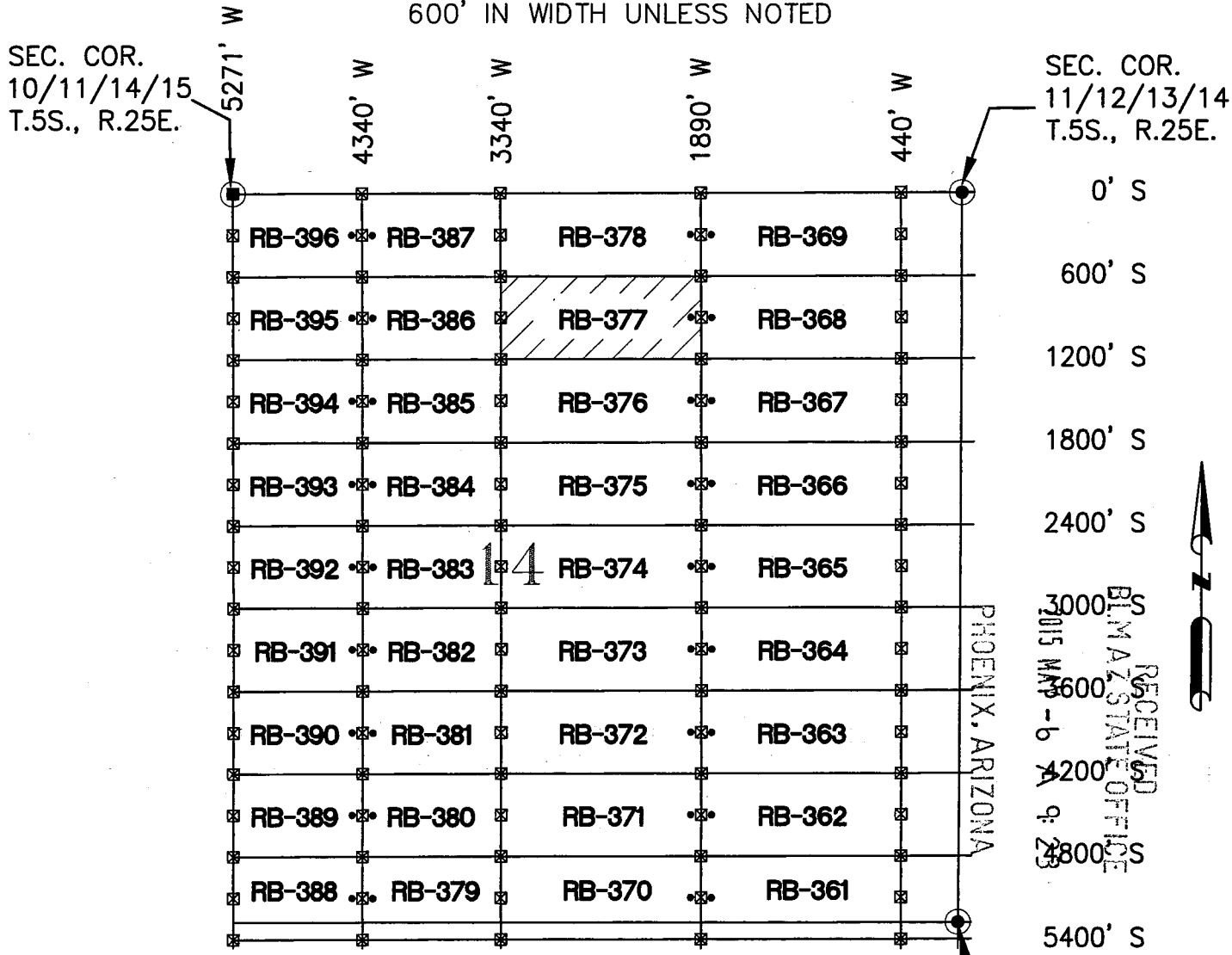

- ☒ INDICATES CORNER OF LODE CLAIM. SET 2"x2"x5' WOODEN POST (TYPICAL)
- INDICATES LOCATION MONUMENT. SET 2"x2"x5' WOODEN POST WITH SIGN (TYPICAL)

LOCATORS:  
FREEPORT MINERALS CORP.  
PO BOX 1019  
SAFFORD AZ 85548

CLAIM ACREAGE = 20.0 AC  
WC = WITNESS CORNER NORTH  
OF SIDE LINE

**Entellus™**  
2255 N. 44th Street Suite 125  
Phoenix, AZ 85008.3279  
Tel 602.244.2566  
Fax 602.244.8947  
Website: [www.Entellus.com](http://www.Entellus.com)

RECEIVED  
BLM ARIZONA STATE OFFICE  
2015 MAR - 6  
3600  
4200  
4800

LOCATION NOTICE FOR LODE MINING CLAIM

Amendment BLM Serial # \_\_\_\_\_

NOTICE IS HEREBY GIVEN that the Red Bull - 378

\_\_\_\_\_ lode mining claim has been located  
by Freeport Minerals Corporation whose current mailing  
address is P.O. Box 1019  
Safford, Arizona 85548

RECEIVED  
BLM AZ STATE OFFICE  
2015 MAY -6 A 9:23  
PHOENIX, ARIZONA  
BLM  
Date  
Stamp

The general course of this claim is East To West and it is situated in Graham  
County, Arizona. This claim is 1450 feet in length and 600 feet in width.

20.0 Total Claim Acreage. This claim runs from the location monument on which this location notice  
is posted on the centerline of the claim approximately 10 feet in a Easterly direction to the East  
end line and 1440 feet in a Westerly direction to the West end line. This claim is marked by six  
monuments, one at each corner and one at the center of each end line of the claim.

The location monument on which this notice is posted is situated within Section 14 Township 5  
S, Range 25 E, Gila Salt River Base and Meridian, Arizona and this claim encompasses portions  
of the following quarter section(s), section(s), Township(s) and Range(s) NE 1/4 and NW 1/4

Section 14 Township 5S Range 25E

Gila Salt River Base and Meridian, Arizona.

The locality of this claim with reference to some natural object or permanent monument and additional information  
(if any) concerning its locality are as follows: The Northeast corner of the claim is 1890' West of the monument at the  
Northeast Corner of Section 14, Township 5S, Range 25E on the section line.

The above information is shown on the attached map.

DATED AND POSTED on the ground this 6 day of April, 2015

LOCATOR(s)  AGENT

Print Name(s) Entellus, Inc. - Daniel G. Francetic, RLS

Signature(s) *Daniel G. Francetic*

Form MCF100  
Revised July 2014

AMC4321371

# RED BULL - 378 CLAIM

## LOCATION OF RED BULL-361 THROUGH RED BULL-396 LODE CLAIMS

LOCATED IN SECTIONS 14 & 23, T.5S., R.25E.

GRAHAM COUNTY, ARIZONA

ALL CLAIMS ARE 1450' IN LENGTH AND 600' IN WIDTH UNLESS NOTED

SEC. COR.  
10/11/14/15  
T.5S., R.25E.

SEC. COR.  
11/12/13/14  
T.5S., R.25E.

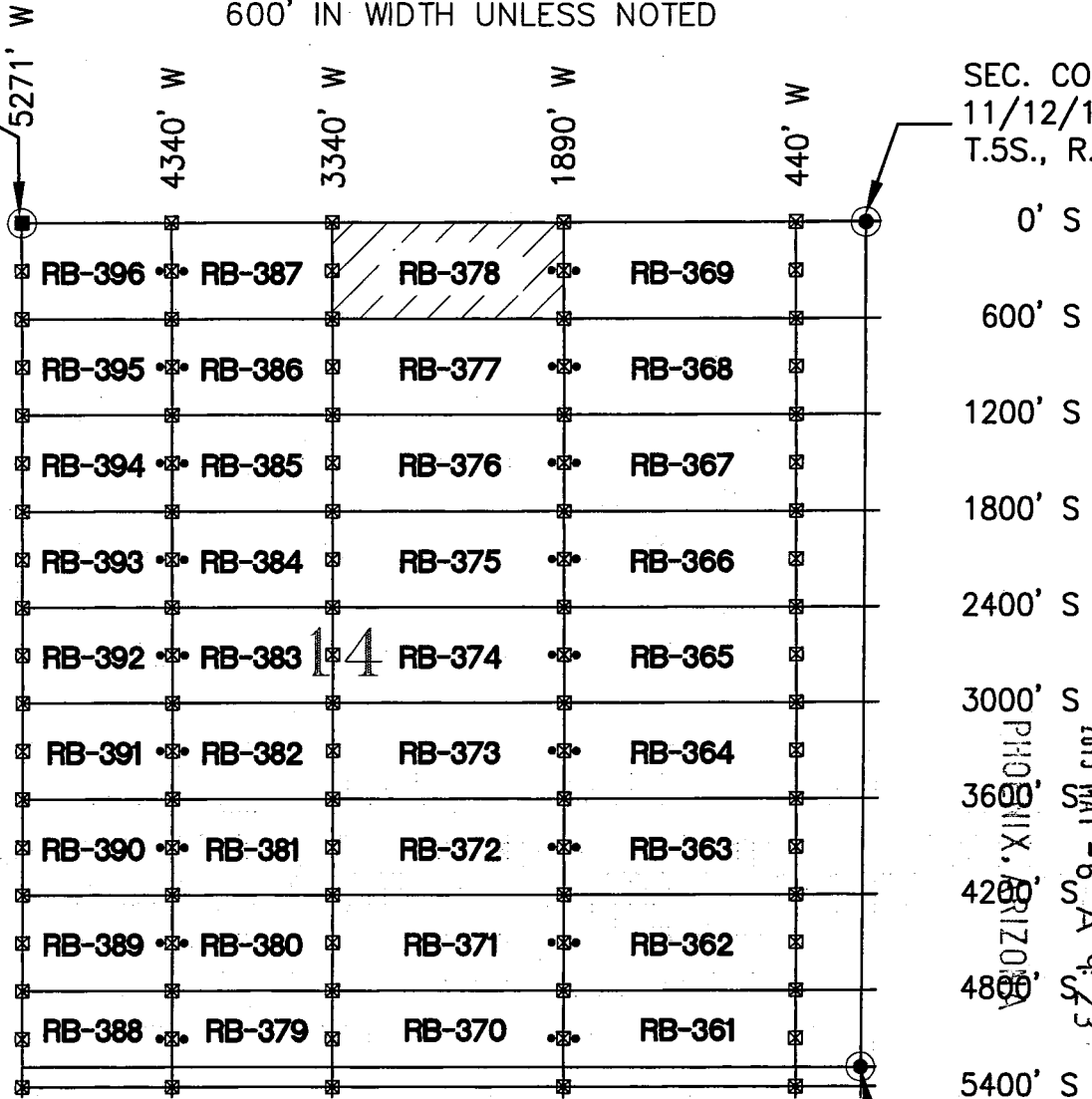

SEC. COR.  
13/14/23/24  
T.5S., R.25E.

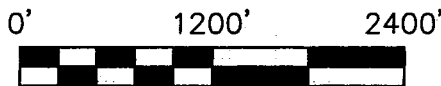
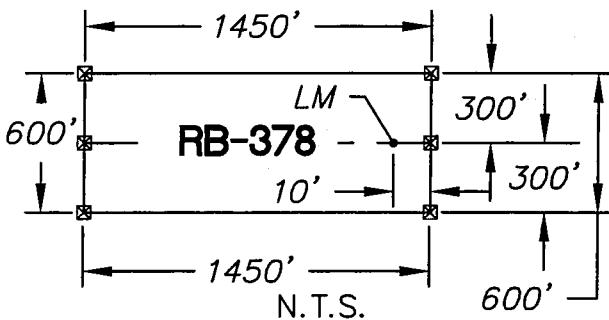

☒ INDICATES CORNER OF LODE CLAIM.  
SET 2"x2"x5' WOODEN POST (TYPICAL)

• INDICATES LOCATION  
MONUMENT. SET 2"x2"x5'  
WOODEN POST WITH SIGN  
(TYPICAL)

LOCATORS:  
FREEPORT MINERALS CORP.  
PO BOX 1019  
SAFFORD AZ 85548

CLAIM ACREAGE = 20.0 AC  
WC = WITNESS CORNER NORTH  
OF SIDE LINE



2255 N. 44th Street Suite 125  
Phoenix, AZ 85008.3279  
Tel 602.244.2566  
Fax 602.244.8947  
Website: www.Entellus.com

RECEIVED  
BIMAZ STATE OFFICE  
2015 MAY -6 5 A 9:23  
PHOENIX, ARIZONA

LOCATION NOTICE FOR LODE MINING CLAIM

Amendment BLM Serial # \_\_\_\_\_

NOTICE IS HEREBY GIVEN that the Red Bull - 433

\_\_\_\_\_ lode mining claim has been located

by Freeport Minerals Corporation whose current mailing

address is P.O. Box 1019

Safford, Arizona 85548

The general course of this claim is East To West and it is situated in Graham

County, Arizona. This claim is 1450 feet in length and 454 feet in width.

15.1 Total Claim Acreage. This claim runs from the location monument on which this location notice

is posted on the centerline of the claim approximately 10 feet in a Westerly direction to the West

end line and 1440 feet in a Easterly direction to the East end line. This claim is marked by six

monuments, one at each corner and one at the center of each end line of the claim.

The location monument on which this notice is posted is situated within Section 24 Township 5

S, Range 25 E, Gila Salt River Base and Meridian, Arizona and this claim encompasses portions

of the following quarter section(s), section(s), Township(s) and Range(s) SE 1/4 Section 24 and NE 1/4 Section 25

Township 5S Range 25E and SW 1/4 Section 19 and NW 1/4 Section 30 Township 5S, Range 26E

Gila Salt River Base and Meridian, Arizona.

The locality of this claim with reference to some natural object or permanent monument and additional information

(if any) concerning its locality are as follows: The Northeast corner of the claim is 4921' South and 100' East of the monument at the

Northeast Corner of Section 24, Township 5S, Range 25E

The above information is shown on the attached map.

DATED AND POSTED on the ground this 7 day of April, 2015.

LOCATOR(s)  AGENT

Print Name(s) Entellus, Inc. - Daniel G. Francetic, RLS

Signature(s) *Daniel G. Francetic*

RECEIVED  
BLM AZ STATE OFFICE  
2015 MAY -6 A 9:21  
PHOENIX, ARIZONA

BLM  
Date  
Stamp

AMC432138

Form MCF100  
Revised July 2014

This form is available from the Arizona Geological Survey and may be reproduced.



# RED BULL - 433 CLAIM

## LOCATION OF RED BULL-433 THROUGH RED BULL-468 LODE CLAIMS

LOCATED IN SECTIONS 23, 24, & 25 T.5S., R.25E., SECTIONS 19 & 30, T.5S., R.26E.  
GRAHAM COUNTY, ARIZONA

ALL CLAIMS ARE 1450' IN LENGTH AND  
600' IN WIDTH UNLESS NOTED

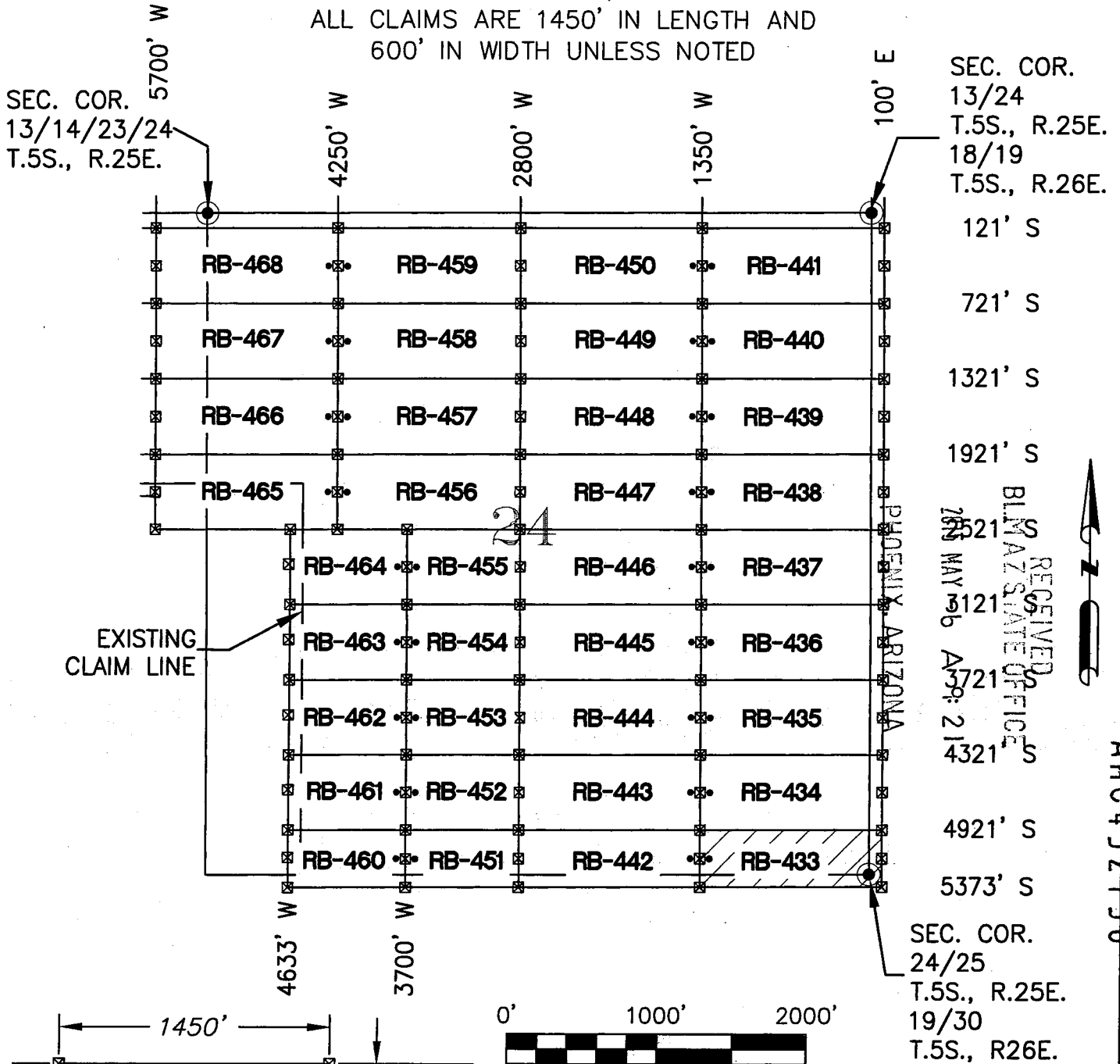

EXISTING CLAIM LINE

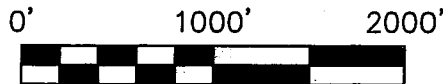
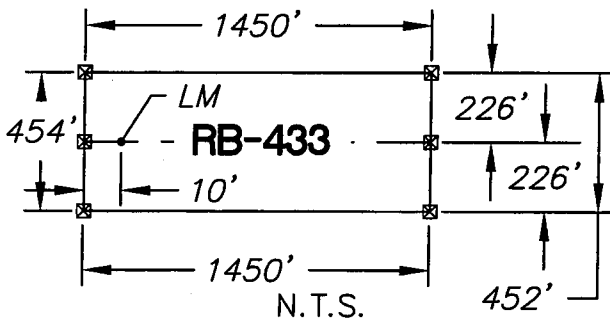

INDICATES CORNER OF LODE CLAIM.  
SET 2"x2"x5' WOODEN POST (TYPICAL)

INDICATES LOCATION  
MONUMENT. SET 2"x2"x5'  
WOODEN POST WITH SIGN  
(TYPICAL)

LOCATORS:  
FREEPORT MINERALS CORP.  
PO BOX 1019  
SAFFORD AZ 85548

CLAIM ACREAGE = 15.1 AC  
WC = WITNESS CORNER NORTH  
OF SIDE LINE

 **Entellus™**  
2255 N. 44th Street Suite 125  
Phoenix, AZ 85008.3279  
Tel 602.244.2566  
Fax 602.244.8947  
Website: www.Entellus.com

**LOCATION NOTICE FOR LODE MINING CLAIM**

Amendment BLM Serial # \_\_\_\_\_

NOTICE IS HEREBY GIVEN that the Red Bull - 434

\_\_\_\_\_ lode mining claim has been located

by Freeport Minerals Corporation whose current mailing

address is P.O. Box 1019

Safford, Arizona 85548

The general course of this claim is East To West and it is situated in

County, Arizona. This claim is 1450 feet in length and 600 feet in width.

20.0 Total Claim Acreage. This claim runs from the location monument on which this location notice

is posted on the centerline of the claim approximately 10 feet in a Westerly direction to the West

end line and 1440 feet in a Easterly direction to the East end line. This claim is marked by six

monuments, one at each corner and one at the center of each end line of the claim.

The location monument on which this notice is posted is situated within Section 24 Township 5

S, Range 25 E, Gila Salt River Base and Meridian, Arizona and this claim encompasses portions

of the following quarter section(s), section(s), Township(s) and Range(s) SE 1/4

Section 24 Township 5S Range 25E and SW 1/4 Section 19 Township 5S Range 26E

Gila Salt River Base and Meridian, Arizona.

The locality of this claim with reference to some natural object or permanent monument and additional information

(if any) concerning its locality are as follows: The Northeast corner of the claim is 4321' South and 100' East of the monument at the

Northeast Corner of Section 24, Township 5S, Range 25E

The above information is shown on the attached map.

DATED AND POSTED on the ground this 7 day of April, 2015

LOCATOR(s)  AGENT

Print Name(s) Entellus, Inc. - Daniel G. Francetic, RLS

Signature(s) *Daniel G. Francetic*

RECEIVED  
BLM AZ STATE OFFICE  
2015 MAY -6 A 9:21  
PHOENIX, ARIZONA  
Graham

AMC 432139

Form MCF100  
Revised July 2014

# RED BULL - 434 CLAIM

## LOCATION OF RED BULL-433 THROUGH RED BULL-468 LODE CLAIMS

LOCATED IN SECTIONS 23, 24, & 25 T.5S., R.25E., SECTIONS 19 & 30, T.5S., R.26E.  
GRAHAM COUNTY, ARIZONA

ALL CLAIMS ARE 1450' IN LENGTH AND  
600' IN WIDTH UNLESS NOTED

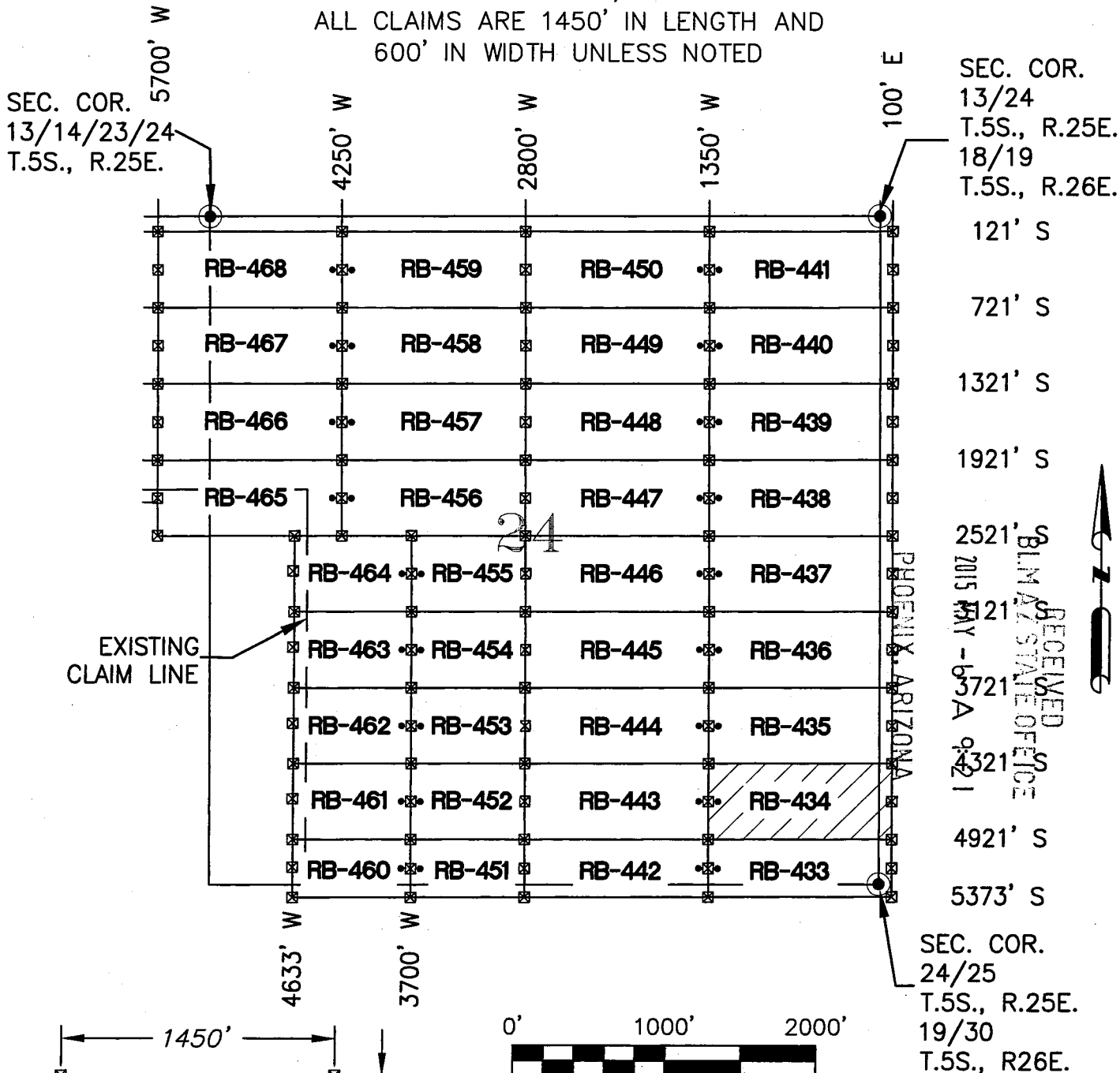

EXISTING CLAIM LINE

SEC. COR.  
13/24  
T.5S., R.25E.  
18/19  
T.5S., R.26E.

121' S  
721' S  
1321' S  
1921' S  
2521' S  
3121' S  
3721' S  
4321' S  
4921' S  
5373' S

SEC. COR.  
24/25  
T.5S., R.25E.  
19/30  
T.5S., R.26E.

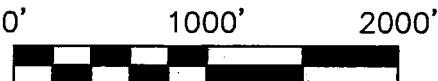
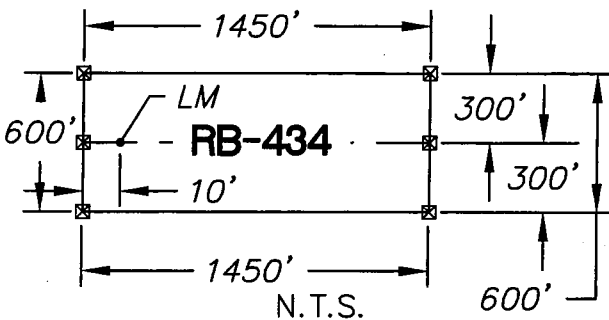

☒ INDICATES CORNER OF LODE CLAIM.  
SET 2"x2"x5' WOODEN POST (TYPICAL)

• INDICATES LOCATION  
MONUMENT. SET 2"x2"x5'  
WOODEN POST WITH SIGN  
(TYPICAL)

**Entellus™**  
2255 N. 44th Street Suite 125  
Phoenix, AZ 85008.3279  
Tel 602.244.2566  
Fax 602.244.8947  
Website: www.Entellus.com

LOCATORS:  
FREEPORT MINERALS CORP.  
PO BOX 1019  
SAFFORD AZ 85548

CLAIM ACREAGE = 20.0 AC  
WC = WITNESS CORNER NORTH  
OF SIDE LINE

RECEIVED  
BLM STATE OFFICE  
2015 MAY - 6  
3721  
4321

RECEIVED  
BLM AZ STATE OFFICE  
2015 MAY -6 A 9:21  
PHOENIX, ARIZONA

**LOCATION NOTICE FOR LODE MINING CLAIM**

Amendment BLM Serial # \_\_\_\_\_

NOTICE IS HEREBY GIVEN that the Red Bull - 435

\_\_\_\_\_ lode mining claim has been located

by Freeport Minerals Corporation whose current mailing

address is P.O. Box 1019

Safford, Arizona 85548

BLM  
Date  
Stamp

The general course of this claim is East To West and it is situated in Graham

County, Arizona. This claim is 1450 feet in length and 600 feet in width.

20.0 Total Claim Acreage. This claim runs from the location monument on which this location notice

is posted on the centerline of the claim approximately 10 feet in a Westerly direction to the West

end line and 1440 feet in a Easterly direction to the East end line. This claim is marked by six

monuments, one at each corner and one at the center of each end line of the claim.

The location monument on which this notice is posted is situated within Section 24 Township 5

S, Range 25 E, Gila Salt River Base and Meridian, Arizona and this claim encompasses portions

of the following quarter section(s), section(s), Township(s) and Range(s) SE 1/4

Section 24 Township 5S Range 25E and SW 1/4 Section 19 Township 5S Range 26E

Gila Salt River Base and Meridian, Arizona.

The locality of this claim with reference to some natural object or permanent monument and additional information

(if any) concerning its locality are as follows: The Northeast corner of the claim is 3721' South and 100' East of the monument at the

Northeast Corner of Section 24, Township 5S, Range 25E

The above information is shown on the attached map.

DATED AND POSTED on the ground this 7 day of April, 2015

LOCATOR(s)  AGENT

Print Name(s) Entellus, Inc. - Daniel G. Francetic, RLS

Signature(s) *Daniel G. Francetic*

Form MCF100  
Revised July 2014

AMC 432140

# RED BULL - 435 CLAIM

## LOCATION OF RED BULL-433 THROUGH RED BULL-468 LODE CLAIMS

LOCATED IN SECTIONS 23, 24, & 25 T.5S., R.25E., SECTIONS 19 & 30, T.5S., R.26E.  
GRAHAM COUNTY, ARIZONA

ALL CLAIMS ARE 1450' IN LENGTH AND  
600' IN WIDTH UNLESS NOTED

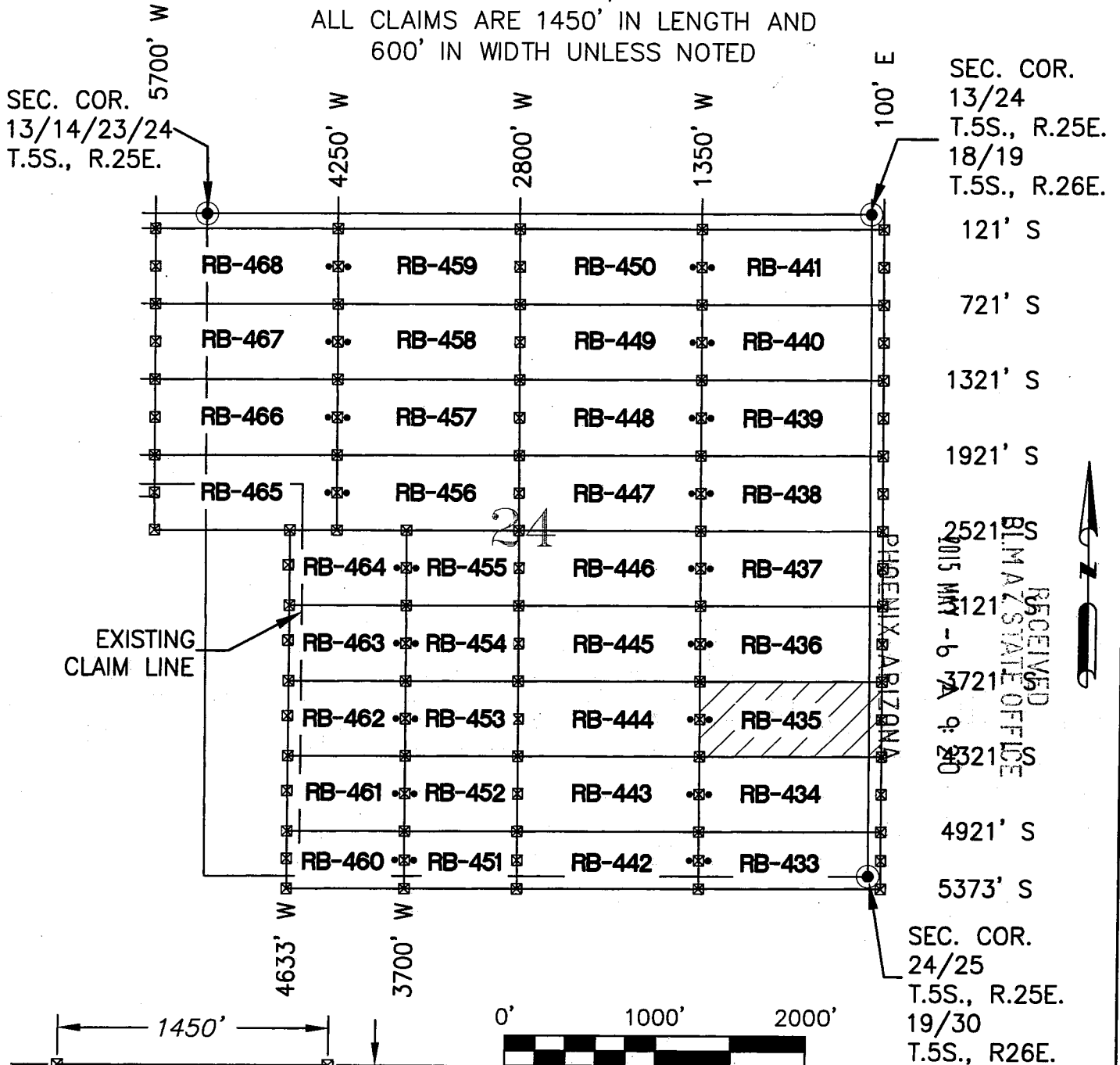

EXISTING CLAIM LINE

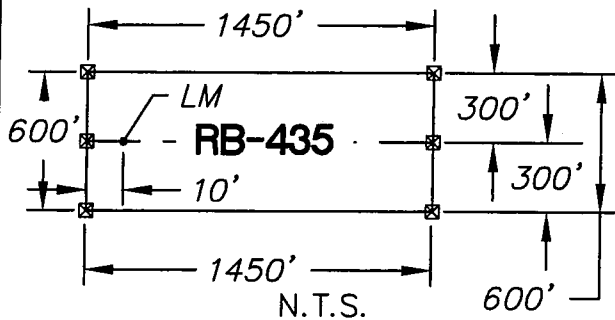

0' 1000' 2000'



☒ INDICATES CORNER OF LODE CLAIM.  
SET 2"x2"x5' WOODEN POST (TYPICAL)

• INDICATES LOCATION  
MONUMENT. SET 2"x2"x5'  
WOODEN POST WITH SIGN  
(TYPICAL)

LOCATORS:  
FREEPORT MINERALS CORP.  
PO BOX 1019  
SAFFORD AZ 85548

CLAIM ACREAGE = 20.0 AC  
WC = WITNESS CORNER NORTH  
OF SIDE LINE



2255 N. 44th Street Suite 125  
Phoenix, AZ 85008.3279  
Tel 602.244.2566  
Fax 602.244.8947  
Website: www.Entellus.com

RECEIVED  
BLM AZ STATE OFFICE  
NOV 5 2015  
MM - 6  
A  
9:20

RECEIVED  
BLM AZ STATE OFFICE  
2015 MAY -6 A 9:20  
PHOENIX, ARIZONA

**LOCATION NOTICE FOR LODE MINING CLAIM**

Amendment      BLM Serial # \_\_\_\_\_

NOTICE IS HEREBY GIVEN that the Red Bull - 436

\_\_\_\_\_ lode mining claim has been located

by Freeport Minerals Corporation whose current mailing

address is P.O. Box 1019

Safford, Arizona 85548

BLM  
Date  
Stamp

The general course of this claim is East To West and it is situated in Graham

County, Arizona. This claim is 1450 feet in length and 600 feet in width.

20.0 Total Claim Acreage. This claim runs from the location monument on which this location notice

is posted on the centerline of the claim approximately 10 feet in a Westerly direction to the West

end line and 1440 feet in a Easterly direction to the East end line. This claim is marked by six

monuments, one at each corner and one at the center of each end line of the claim.

The location monument on which this notice is posted is situated within Section 24 Township 5

S, Range 25 E, Gila Salt River Base and Meridian, Arizona and this claim encompasses portions

of the following quarter section(s), section(s), Township(s) and Range(s) SE 1/4

Section 24 Township 5S Range 25E and SW 1/4 Section 19 Township 5S Range 26E

Gila Salt River Base and Meridian, Arizona.

The locality of this claim with reference to some natural object or permanent monument and additional information

(if any) concerning its locality are as follows: The Northeast corner of the claim is 3121' South and 100' East of the monument at the

Northeast Corner of Section 24, Township 5S, Range 25E

The above information is shown on the attached map.

DATED AND POSTED on the ground this 7 day of April, 2015.

LOCATOR(s)       AGENT

Print Name(s) Entellus, Inc. - Daniel G. Francetic, RLS

Signature(s) *Daniel G. Francetic*

Form MCF100  
Revised July 2014

AMC4321411

# RED BULL - 436 CLAIM

## LOCATION OF RED BULL-433 THROUGH RED BULL-468 LODE CLAIMS

LOCATED IN SECTIONS 23, 24, & 25 T.5S., R.25E., SECTIONS 19 & 30, T.5S., R.26E.  
GRAHAM COUNTY, ARIZONA

ALL CLAIMS ARE 1450' IN LENGTH AND  
600' IN WIDTH UNLESS NOTED

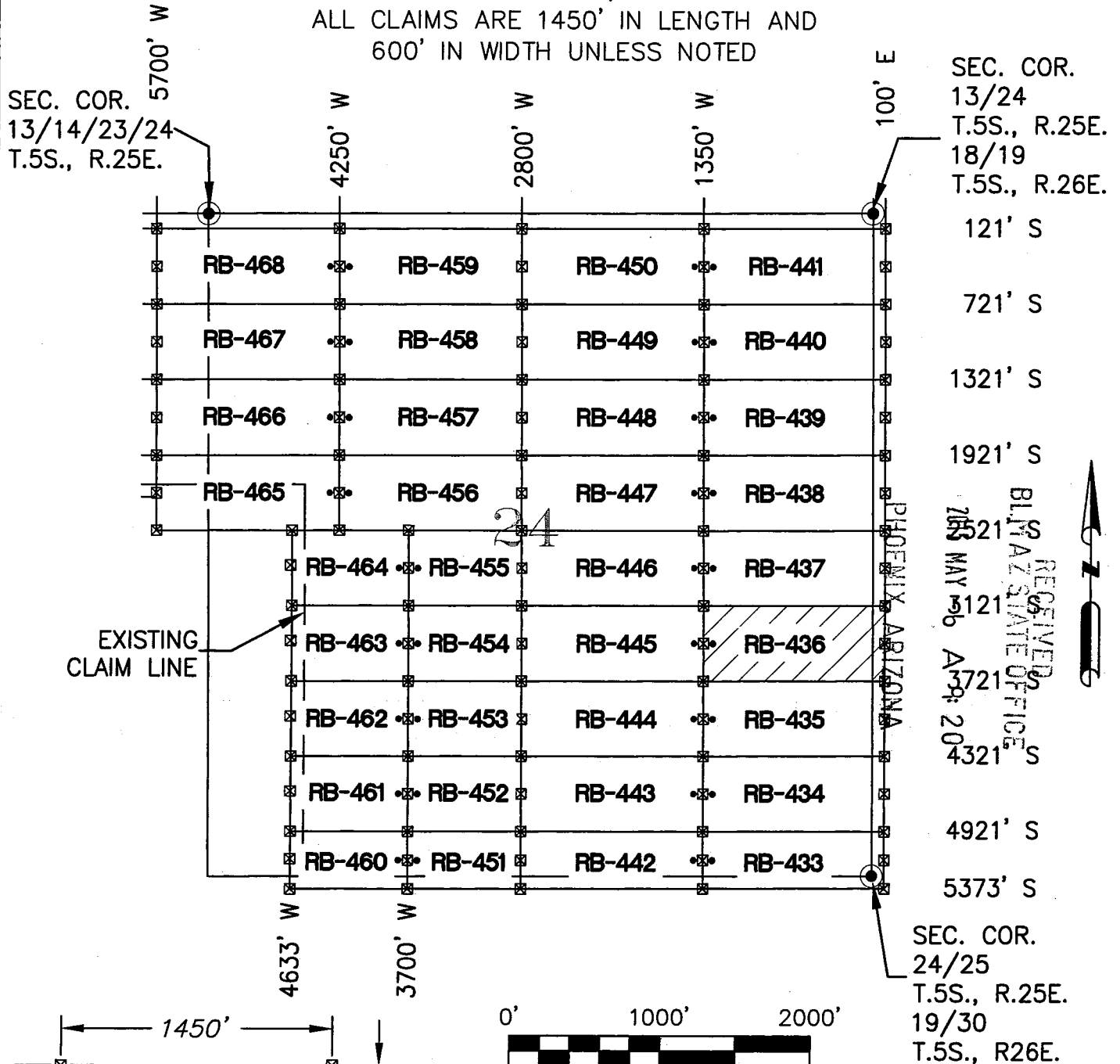

EXISTING CLAIM LINE

RECEIVED  
BLM AZ STATE OFFICE  
MAY 26 APR 20  
2006

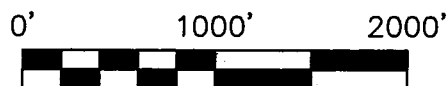
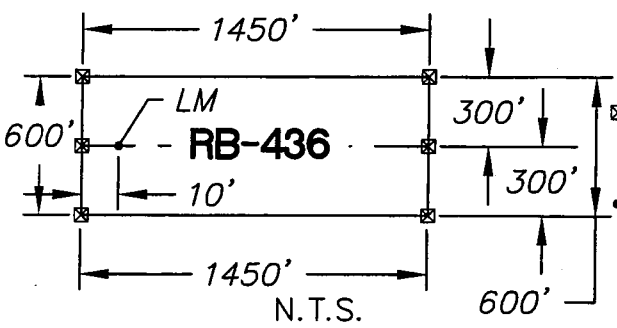

- ⊠ INDICATES CORNER OF LODE CLAIM. SET 2"x2"x5' WOODEN POST (TYPICAL)
- INDICATES LOCATION MONUMENT. SET 2"x2"x5' WOODEN POST WITH SIGN (TYPICAL)

LOCATORS:  
FREEPORT MINERALS CORP.  
PO BOX 1019  
SAFFORD AZ 85548

CLAIM ACREAGE = 20.0 AC  
WC = WITNESS CORNER NORTH  
OF SIDE LINE

**Entellus™**  
2255 N. 44th Street Suite 125  
Phoenix, AZ 85008.3279  
Tel 602.244.2566  
Fax 602.244.8947  
Website: www.Entellus.com

**LOCATION NOTICE FOR LODE MINING CLAIM**

Amendment BLM Serial # \_\_\_\_\_

NOTICE IS HEREBY GIVEN that the Red Bull - 437

\_\_\_\_\_ lode mining claim has been located

by Freeport Minerals Corporation whose current mailing

address is P.O. Box 1019

Safford, Arizona 85548

The general course of this claim is East To West and it is situated in Graham

County, Arizona. This claim is 1450 feet in length and 600 feet in width.

20.0 Total Claim Acreage. This claim runs from the location monument on which this location notice

is posted on the centerline of the claim approximately 10 feet in a Westerly direction to the West

end line and 1440 feet in a Easterly direction to the East end line. This claim is marked by six

monuments, one at each corner and one at the center of each end line of the claim.

The location monument on which this notice is posted is situated within Section 24 Township 5

S, Range 25 E, Gila Salt River Base and Meridian, Arizona and this claim encompasses portions

of the following quarter section(s), section(s), Township(s) and Range(s) SE 1/4 and NE 1/4

Section 24 Township 5S Range 25E and NW 1/4 and SW 1/4 Section 19 Township 5S Range 26E

Gila Salt River Base and Meridian, Arizona.

The locality of this claim with reference to some natural object or permanent monument and additional information

(if any) concerning its locality are as follows: The Northeast corner of the claim is 2521' South and 100' East of the monument at the

Northeast Corner of Section 24, Township 5S, Range 25E

The above information is shown on the attached map.

DATED AND POSTED on the ground this 7 day of April, 2015

LOCATOR(s)  AGENT

Print Name(s) Entellus, Inc. - Daniel G. Francetic, RLS

Signature(s) *Daniel G. Francetic*

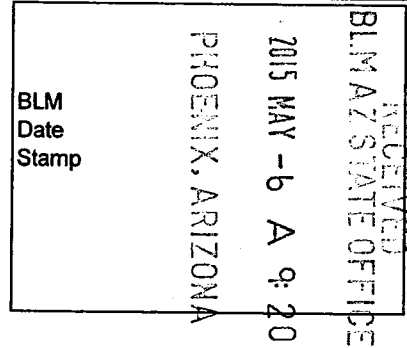

AMC432142

Form MCF100 Revised July 2014



# RED BULL - 437 CLAIM

## LOCATION OF RED BULL-433 THROUGH RED BULL-468 LODE CLAIMS

LOCATED IN SECTIONS 23, 24, & 25 T.5S., R.25E., SECTIONS 19 & 30, T.5S., R.26E.  
GRAHAM COUNTY, ARIZONA

ALL CLAIMS ARE 1450' IN LENGTH AND  
600' IN WIDTH UNLESS NOTED

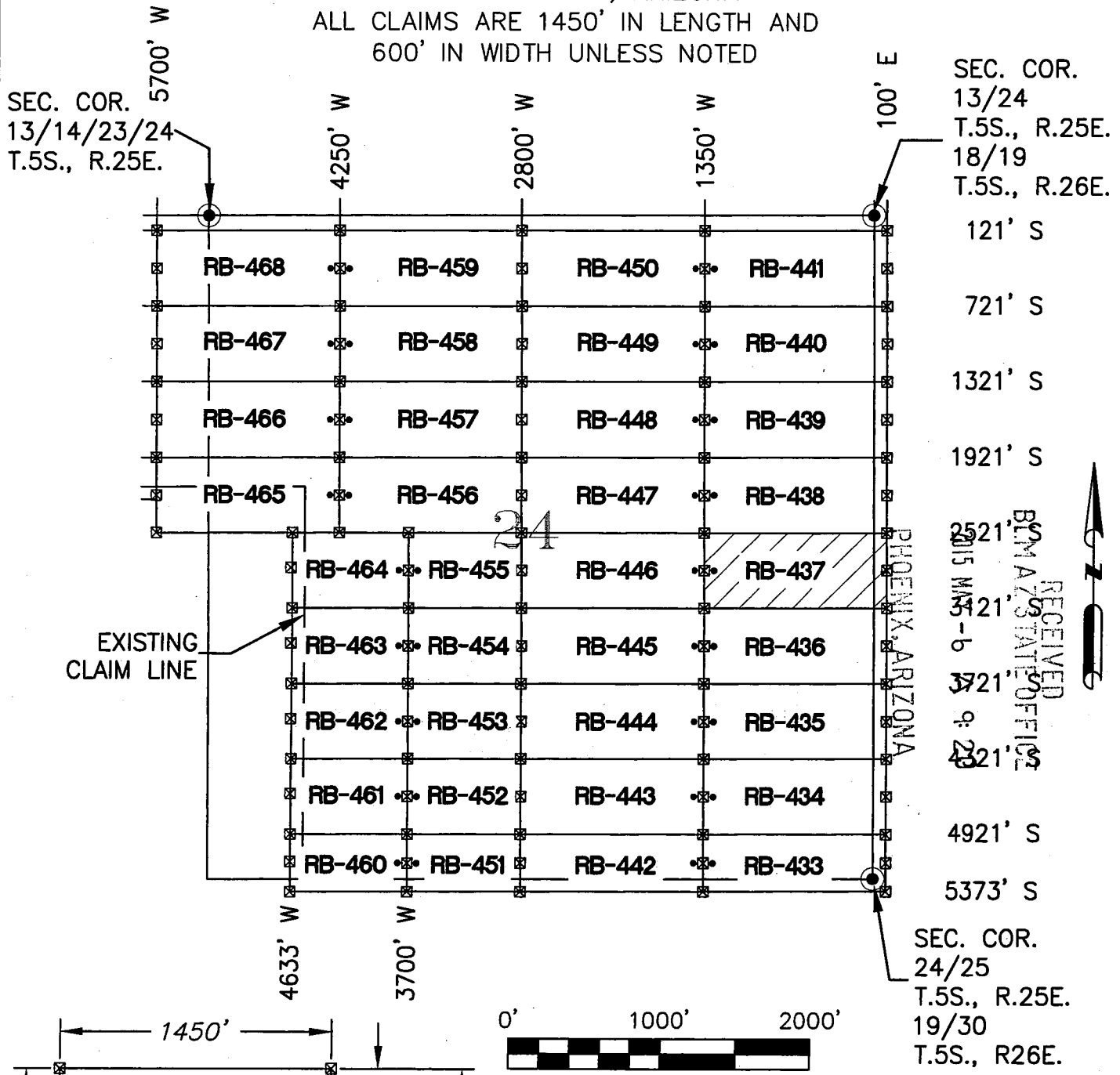

SEC. COR.  
13/24  
T.5S., R.25E.  
18/19  
T.5S., R.26E.  
121' S  
721' S  
1321' S  
1921' S  
2521' S  
3121' S  
3721' S  
4321' S  
4921' S  
5373' S  
SEC. COR.  
24/25  
T.5S., R.25E.  
19/30  
T.5S., R.26E.

RECEIVED  
BLM AZ STATE OFFICE  
2015 MAR 5 - 6

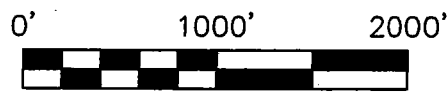
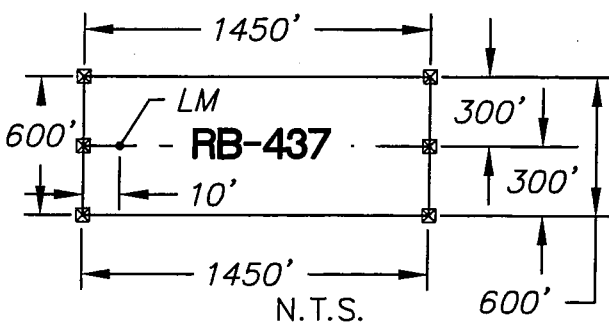

☒ INDICATES CORNER OF LODE CLAIM.  
SET 2"x2"x5' WOODEN POST (TYPICAL)

• INDICATES LOCATION  
MONUMENT. SET 2"x2"x5'  
WOODEN POST WITH SIGN  
(TYPICAL)

LOCATORS:  
FREEPORT MINERALS CORP.  
PO BOX 1019  
SAFFORD AZ 85548

CLAIM ACREAGE = 20.0 AC  
WC = WITNESS CORNER NORTH  
OF SIDE LINE

**Entellus™**  
2255 N. 44th Street Suite 125  
Phoenix, AZ 85008.3279  
Tel 602.244.2566  
Fax 602.244.8947  
Website: www.Entellus.com

**LOCATION NOTICE FOR LODE MINING CLAIM**

Amendment      BLM Serial # \_\_\_\_\_

NOTICE IS HEREBY GIVEN that the Red Bull - 438

\_\_\_\_\_ lode mining claim has been located

by Freeport Minerals Corporation whose current mailing

address is P.O. Box 1019

Safford, Arizona 85548

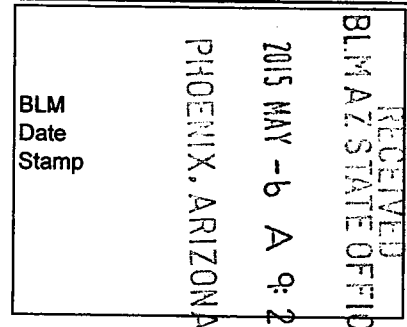

The general course of this claim is East To West and it is situated in Graham

County, Arizona. This claim is 1450 feet in length and 600 feet in width.

20.0 Total Claim Acreage. This claim runs from the location monument on which this location notice

is posted on the centerline of the claim approximately 10 feet in a Westerly direction to the West

end line and 1440 feet in a Easterly direction to the East end line. This claim is marked by six

monuments, one at each corner and one at the center of each end line of the claim.

The location monument on which this notice is posted is situated within Section 24 Township 5

S, Range 25 E, Gila Salt River Base and Meridian, Arizona and this claim encompasses portions

of the following quarter section(s), section(s), Township(s) and Range(s) NE 1/4

Section 24 Township 5S Range 25E and NW 1/4 Section 19 Township 5S Range 26E

Gila Salt River Base and Meridian, Arizona.

The locality of this claim with reference to some natural object or permanent monument and additional information

(if any) concerning its locality are as follows: The Northeast corner of the claim is 1921' South and 100' East of the monument at the

Northeast Corner of Section 24, Township 5S, Range 25E

The above information is shown on the attached map.

DATED AND POSTED on the ground this 7 day of April, 2015.

LOCATOR(s)       AGENT

Print Name(s) Entellus, Inc. - Daniel G. Francetic, RLS

Signature(s) *Daniel G. Francetic*

Form MCF100  
Revised July 2014

AN C 4 3 2 1 4 3

# RED BULL - 438 CLAIM

## LOCATION OF RED BULL-433 THROUGH RED BULL-468 LODE CLAIMS

LOCATED IN SECTIONS 23, 24, & 25 T.5S., R.25E., SECTIONS 19 & 30, T.5S., R.26E.  
GRAHAM COUNTY, ARIZONA

ALL CLAIMS ARE 1450' IN LENGTH AND  
600' IN WIDTH UNLESS NOTED

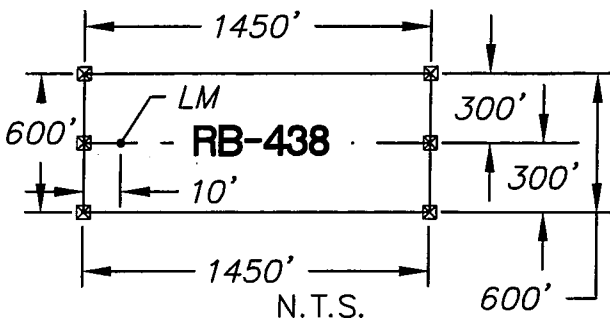
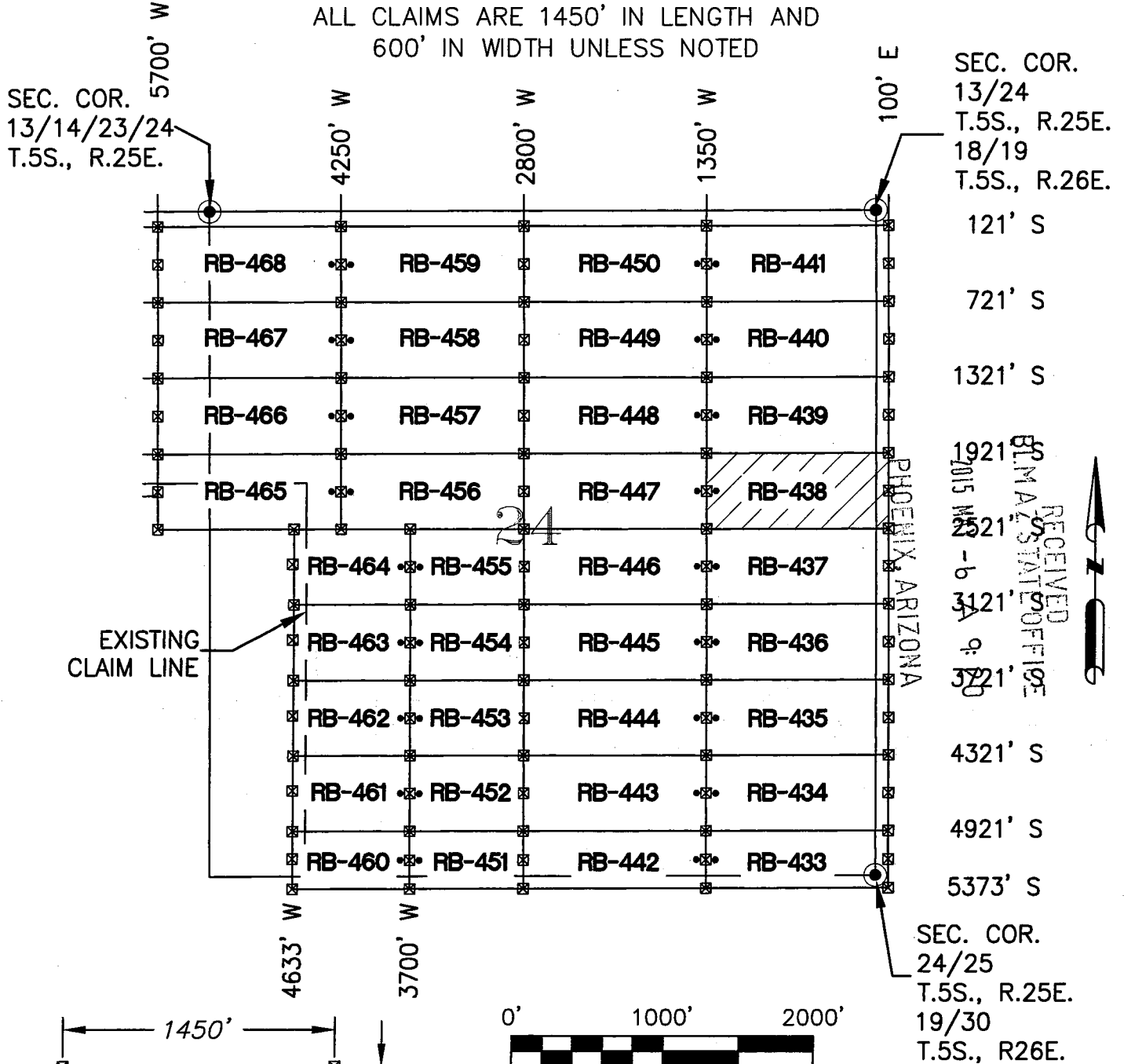

INDICATES CORNER OF LODE CLAIM.  
SET 2"x2"x5' WOODEN POST (TYPICAL)

INDICATES LOCATION  
MONUMENT. SET 2"x2"x5'  
WOODEN POST WITH SIGN  
(TYPICAL)

LOCATORS:  
FREEPORT MINERALS CORP.  
PO BOX 1019  
SAFFORD AZ 85548

CLAIM ACREAGE = 20.0 AC  
WC = WITNESS CORNER NORTH  
OF SIDE LINE

**Entellus™**  
2255 N. 44th Street Suite 125  
Phoenix, AZ 85008.3279  
Tel 602.244.2566  
Fax 602.244.8947  
Website: www.Entellus.com

RECEIVED  
BLM ARIZONA STATE OFFICE  
2015 MAR - 6  
3121' S  
3721' S



**LOCATION NOTICE FOR LODE MINING CLAIM**

Amendment      BLM Serial # \_\_\_\_\_

NOTICE IS HEREBY GIVEN that the Red Bull - 439

\_\_\_\_\_ lode mining claim has been located

by Freeport Minerals Corporation whose current mailing

address is P.O. Box 1019

Safford, Arizona 85548

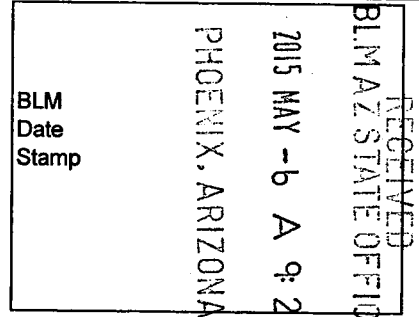

The general course of this claim is East To West and it is situated in Graham

County, Arizona. This claim is 1450 feet in length and 600 feet in width.

20.0 Total Claim Acreage. This claim runs from the location monument on which this location notice

is posted on the centerline of the claim approximately 10 feet in a Westerly direction to the West

end line and 1440 feet in a Easterly direction to the East end line. This claim is marked by six

monuments, one at each corner and one at the center of each end line of the claim.

The location monument on which this notice is posted is situated within Section 24 Township 5

S, Range 25 E, Gila Salt River Base and Meridian, Arizona and this claim encompasses portions

of the following quarter section(s), section(s), Township(s) and Range(s) NE 1/4

Section 24 Township 5S Range 25E and NW 1/4 Section 19 Township 5S Range 26E

Gila Salt River Base and Meridian, Arizona.

The locality of this claim with reference to some natural object or permanent monument and additional information

(if any) concerning its locality are as follows: The Northeast corner of the claim is 1321' South and 100' East of the monument at the

Northeast Corner of Section 24, Township 5S, Range 25E

The above information is shown on the attached map.

DATED AND POSTED on the ground this 7 day of April, 2015.

LOCATOR(s)       AGENT

Print Name(s) Entellus, Inc. - Daniel G. Francetic, RLS

Signature(s) *Daniel G. Francetic*

Form MCF100  
Revised July 2014

AMC432144

# RED BULL - 439 CLAIM

## LOCATION OF RED BULL-433 THROUGH RED BULL-468 LODE CLAIMS

LOCATED IN SECTIONS 23, 24, & 25 T.5S., R.25E., SECTIONS 19 & 30, T.5S., R.26E.  
GRAHAM COUNTY, ARIZONA

ALL CLAIMS ARE 1450' IN LENGTH AND  
600' IN WIDTH UNLESS NOTED

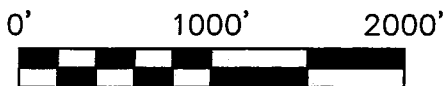
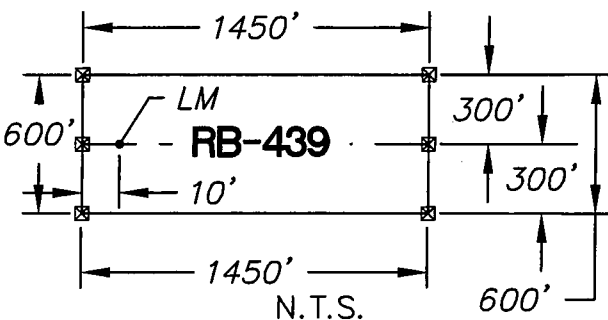
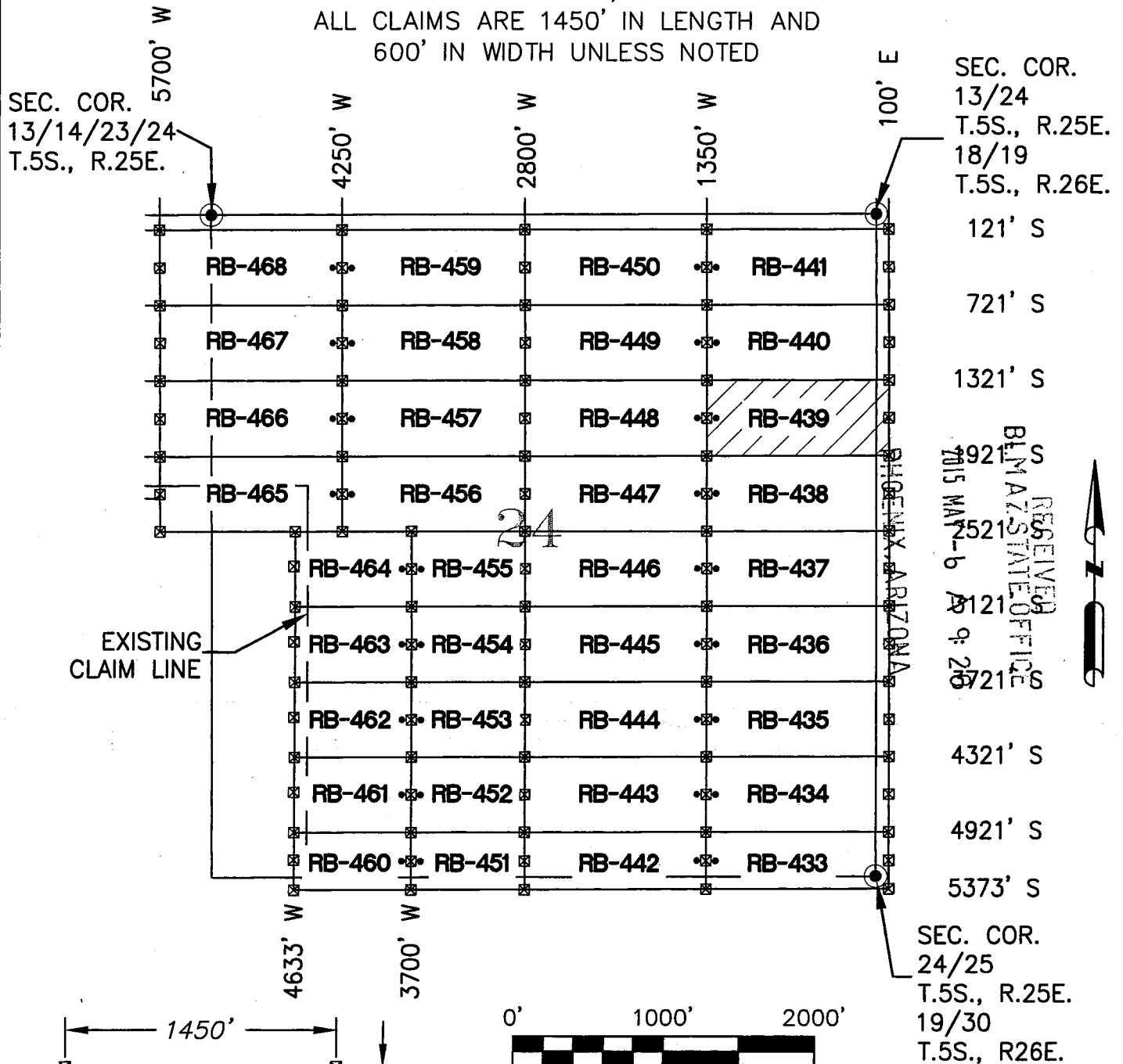

- ☒ INDICATES CORNER OF LODE CLAIM. SET 2"x2"x5' WOODEN POST (TYPICAL)
- INDICATES LOCATION MONUMENT. SET 2"x2"x5' WOODEN POST WITH SIGN (TYPICAL)

LOCATORS:  
FREEPORT MINERALS CORP.  
PO BOX 1019  
SAFFORD AZ 85548

CLAIM ACREAGE = 20.0 AC  
WC = WITNESS CORNER NORTH  
OF SIDE LINE

 **Entellus™**  
2255 N. 44th Street Suite 125  
Phoenix, AZ 85008.3279  
Tel 602.244.2566  
Fax 602.244.8947  
Website: www.Entellus.com

RECEIVED  
BLM AZ STATE OFFICE  
2015 MAR - 6  
9:29  
3721' S

LOCATION NOTICE FOR LODE MINING CLAIM

Amendment BLM Serial # \_\_\_\_\_

NOTICE IS HEREBY GIVEN that the Red Bull - 440

\_\_\_\_\_ lode mining claim has been located

by Freeport Minerals Corporation whose current mailing

address is P.O. Box 1019

Safford, Arizona 85548

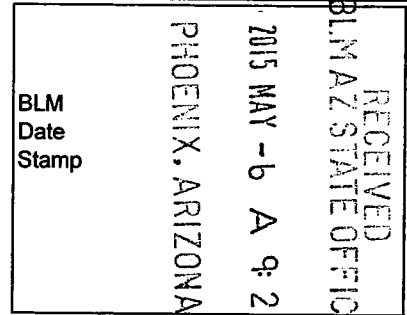

The general course of this claim is East To West and it is situated in Graham

County, Arizona. This claim is 1450 feet in length and 600 feet in width.

20.0 Total Claim Acreage. This claim runs from the location monument on which this location notice

is posted on the centerline of the claim approximately 10 feet in a Westerly direction to the West

end line and 1440 feet in a Easterly direction to the East end line. This claim is marked by six

monuments, one at each corner and one at the center of each end line of the claim.

The location monument on which this notice is posted is situated within Section 24 Township 5

S, Range 25 E, Gila Salt River Base and Meridian, Arizona and this claim encompasses portions

of the following quarter section(s), section(s), Township(s) and Range(s) NE 1/4

Section 24 Township 5S Range 25E and NW 1/4 Section 19 Township 5S Range 26E

Gila Salt River Base and Meridian, Arizona.

The locality of this claim with reference to some natural object or permanent monument and additional information

(if any) concerning its locality are as follows: The Northeast corner of the claim is 721' South and 100' East of the monument at the

Northeast Corner of Section 24, Township 5S, Range 25E

The above information is shown on the attached map.

DATED AND POSTED on the ground this 7 day of April, 2015.

LOCATOR(s)  AGENT

Print Name(s) Entellus, Inc. - Daniel G. Francetic, RLS

Signature(s) *Daniel G. Francetic*

Form MCF100 Revised July 2014

This form is available from the Arizona Geological Survey and may be reproduced.

AMC432145

# RED BULL - 440 CLAIM

## LOCATION OF RED BULL-433 THROUGH RED BULL-468 LODE CLAIMS

LOCATED IN SECTIONS 23, 24, & 25 T.5S., R.25E., SECTIONS 19 & 30, T.5S., R.26E.  
GRAHAM COUNTY, ARIZONA

ALL CLAIMS ARE 1450' IN LENGTH AND  
600' IN WIDTH UNLESS NOTED

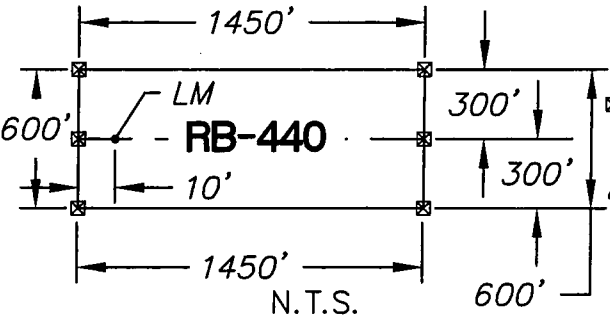
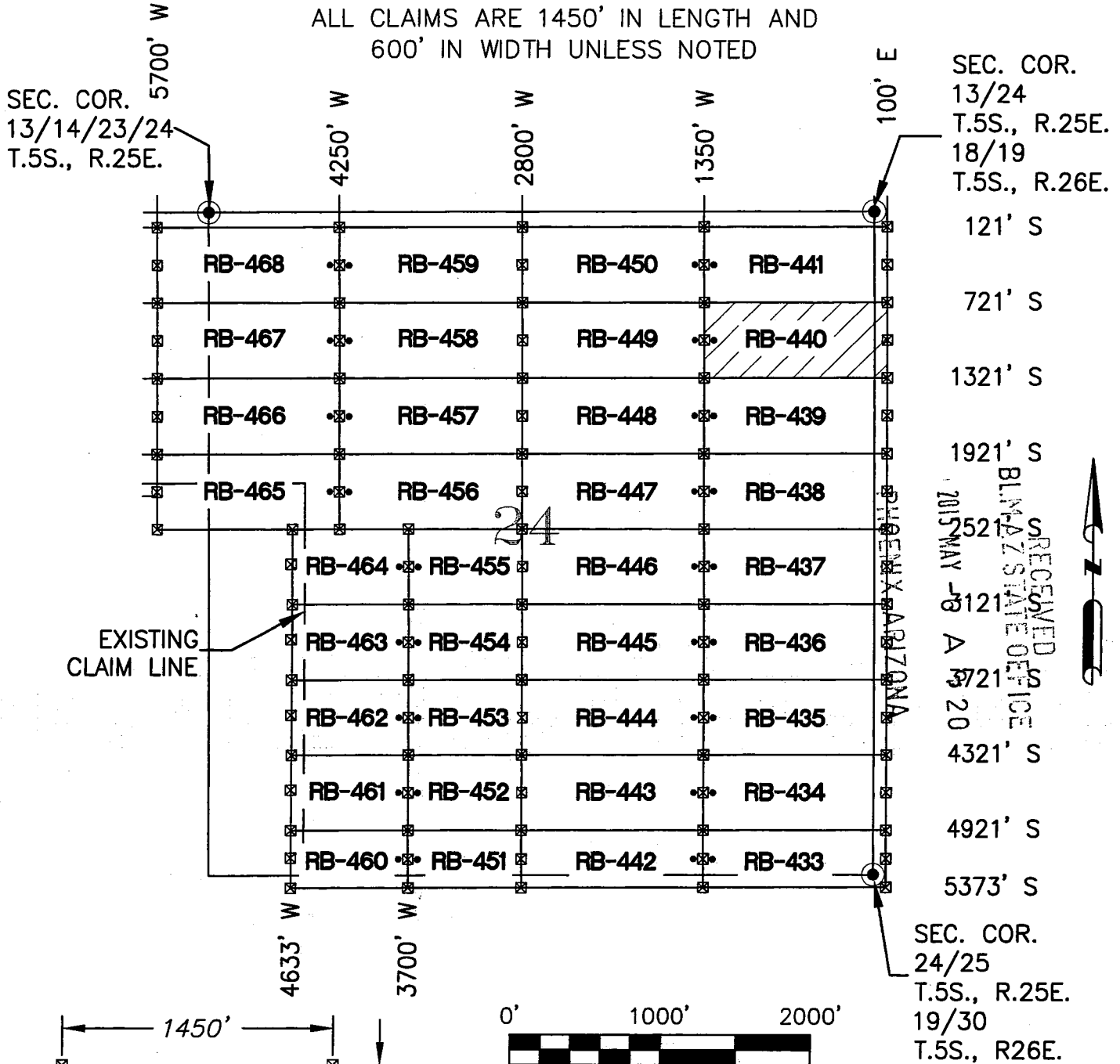

INDICATES CORNER OF LODE CLAIM.  
 SET 2"x2"x5' WOODEN POST (TYPICAL)

INDICATES LOCATION  
 MONUMENT. SET 2"x2"x5'  
 WOODEN POST WITH SIGN  
 (TYPICAL)

LOCATORS:  
 FREEPORT MINERALS CORP.  
 PO BOX 1019  
 SAFFORD AZ 85548

CLAIM ACREAGE = 20.0 AC  
 WC = WITNESS CORNER NORTH  
 OF SIDE LINE



**Entellus™**

2255 N. 44th Street Suite 125  
 Phoenix, AZ 85008.3279  
 Tel 602.244.2566  
 Fax 602.244.8947  
 Website: www.Entellus.com

RECEIVED  
 BLMAZ STATE OFFICE  
 2015 MAY 18 A 3721  
 20

RECEIVED  
BLM AZ STATE OFFICE  
2015 MAY -6 A 9:20  
PHOENIX, ARIZONA

**LOCATION NOTICE FOR LODE MINING CLAIM**

Amendment BLM Serial # \_\_\_\_\_

NOTICE IS HEREBY GIVEN that the Red Bull - 441

\_\_\_\_\_ lode mining claim has been located

by Freeport Minerals Corporation whose current mailing

address is P.O. Box 1019

Safford, Arizona 85548

BLM  
Date  
Stamp

The general course of this claim is East To West and it is situated in Graham

County, Arizona. This claim is 1450 feet in length and 600 feet in width.

20.0 Total Claim Acreage. This claim runs from the location monument on which this location notice

is posted on the centerline of the claim approximately 10 feet in a Westerly direction to the West

end line and 1440 feet in a Easterly direction to the East end line. This claim is marked by six

monuments, one at each corner and one at the center of each end line of the claim.

The location monument on which this notice is posted is situated within Section 24 Township 5

S, Range 25 E, Gila Salt River Base and Meridian, Arizona and this claim encompasses portions

of the following quarter section(s), section(s), Township(s) and Range(s) NE 1/4

Section 24 Township 5S Range 25E and NW 1/4 Section 19 Township 5S Range 26E

Gila Salt River Base and Meridian, Arizona.

The locality of this claim with reference to some natural object or permanent monument and additional information

(if any) concerning its locality are as follows: The Northeast corner of the claim is 121' South and 100' East of the monument at the

Northeast Corner of Section 24, Township 5S, Range 25E

The above information is shown on the attached map.

DATED AND POSTED on the ground this 7 day of April, 2015

LOCATOR(s)  AGENT

Print Name(s) Entellus, Inc. - Daniel G. Francetic, RLS

Signature(s) *Daniel G. Francetic*

Form MCF100  
Revised July 2014

AMC432146



# RED BULL - 441 CLAIM

## LOCATION OF RED BULL-433 THROUGH RED BULL-468 LODE CLAIMS

LOCATED IN SECTIONS 23, 24, & 25 T.5S., R.25E., SECTIONS 19 & 30, T.5S., R.26E.  
GRAHAM COUNTY, ARIZONA

ALL CLAIMS ARE 1450' IN LENGTH AND  
600' IN WIDTH UNLESS NOTED

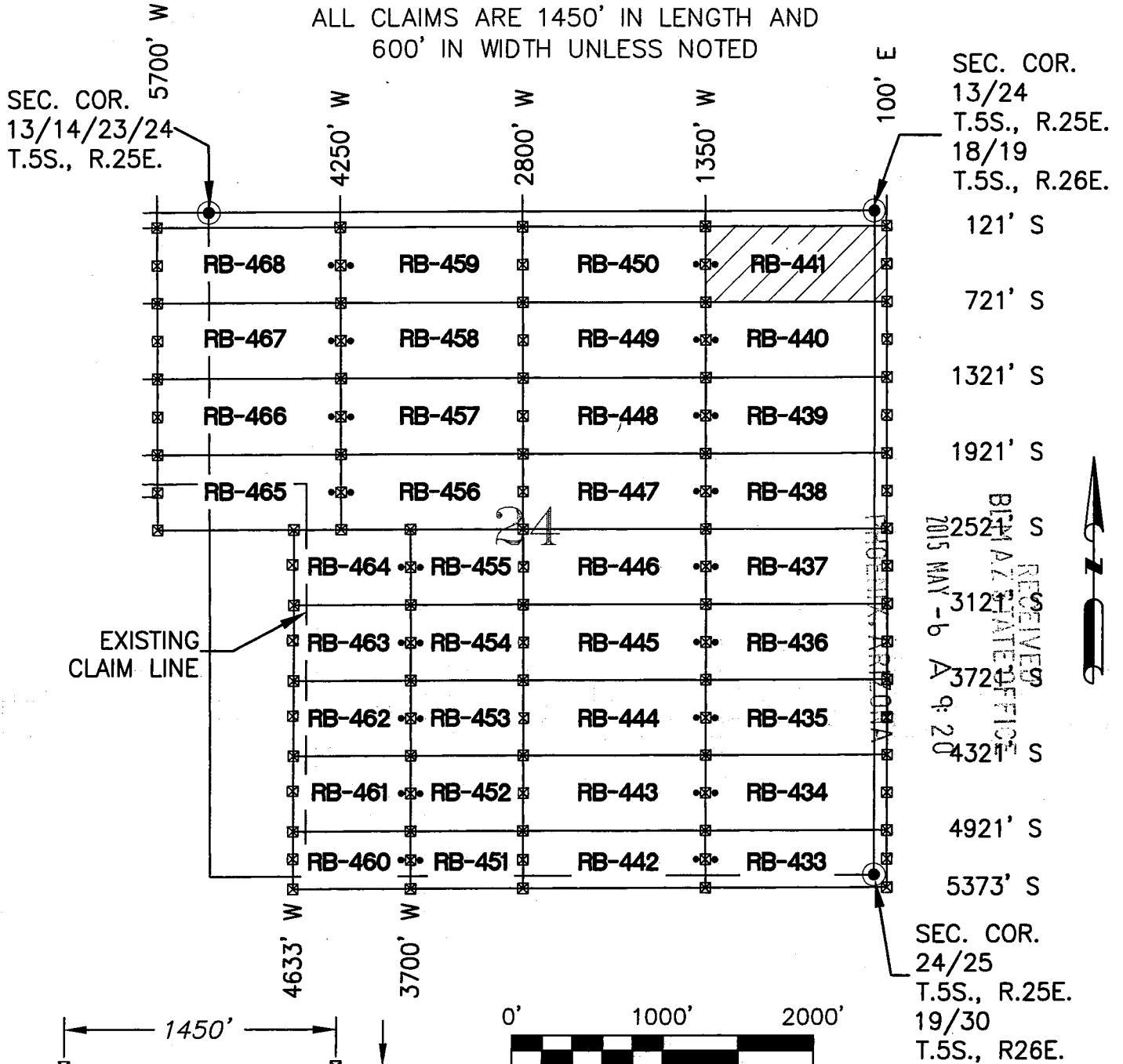

SEC. COR.  
13/24  
T.5S., R.25E.  
18/19  
T.5S., R.26E.  
121' S  
721' S  
1321' S  
1921' S  
2521' S  
3121' S  
3721' S  
4321' S  
4921' S  
5373' S  
SEC. COR.  
24/25  
T.5S., R.25E.  
19/30  
T.5S., R.26E.

RECEIVED  
 BLM ARIZONA STATE OFFICE  
 2015 MAY - 6 A 9:20  
 4321' S

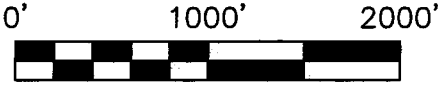
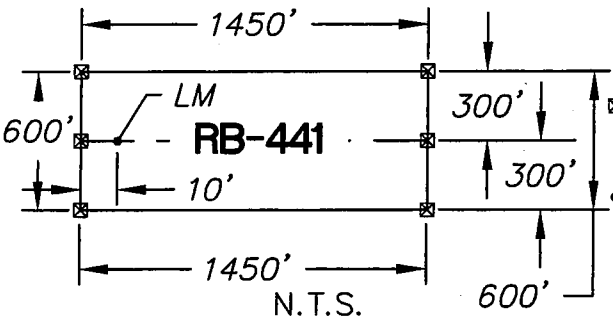

⊠ INDICATES CORNER OF LODE CLAIM.  
 SET 2"x2"x5' WOODEN POST (TYPICAL)  
 • INDICATES LOCATION  
 MONUMENT. SET 2"x2"x5'  
 WOODEN POST WITH SIGN  
 (TYPICAL)

LOCATORS:  
 FREEPORT MINERALS CORP.  
 PO BOX 1019  
 SAFFORD AZ 85548

CLAIM ACREAGE = 20.0 AC  
 WC = WITNESS CORNER NORTH  
 OF SIDE LINE

**Entellus™**  
 2255 N. 44th Street Suite 125  
 Phoenix, AZ 85008.3279  
 Tel 602.244.2566  
 Fax 602.244.8947  
 Website: www.Entellus.com

LOCATION NOTICE FOR LODE MINING CLAIM

Amendment BLM Serial # \_\_\_\_\_

NOTICE IS HEREBY GIVEN that the Red Bull - 442

\_\_\_\_\_ lode mining claim has been located

by Freeport Minerals Corporation whose current mailing

address is P.O. Box 1019

Safford, Arizona 85548

BLM  
Date  
Stamp

PHOENIX, ARIZONA  
2015 MAY -6 A 9:20

RECEIVED  
BLM STATE OFFICE

The general course of this claim is East To West and it is situated in Graham

County, Arizona. This claim is 1450 feet in length and 455 feet in width.

15.1 Total Claim Acreage. This claim runs from the location monument on which this location notice

is posted on the centerline of the claim approximately 10 feet in a Easterly direction to the East

end line and 1440 feet in a Westerly direction to the West end line. This claim is marked by six

monuments, one at each corner and one at the center of each end line of the claim.

The location monument on which this notice is posted is situated within Section 24 Township 5

S, Range 25 E, Gila Salt River Base and Meridian, Arizona and this claim encompasses portions

of the following quarter section(s), section(s), Township(s) and Range(s) SE 1/4 and SW 1/4

Section 24 Township 5S Range 25E and NE 1/4 and NW 1/4 Section 25 Township 5S Range 25E

Gila Salt River Base and Meridian, Arizona.

The locality of this claim with reference to some natural object or permanent monument and additional information

(if any) concerning its locality are as follows: The Northeast corner of the claim is 4921' South and 1350' West of the monument at the

Northeast Corner of Section 24, Township 5S, Range 25E

The above information is shown on the attached map.

DATED AND POSTED on the ground this 7 day of April, 2015.

LOCATOR(s)  AGENT

Print Name(s) Entellus, Inc. - Daniel G. Francetic, RLS

Signature(s) *Daniel G. Francetic*

Form MCF100  
Revised July 2014

AMC432147

# RED BULL - 442 CLAIM

## LOCATION OF RED BULL-433 THROUGH RED BULL-468 LODE CLAIMS

LOCATED IN SECTIONS 23, 24, & 25 T.5S., R.25E., SECTIONS 19 & 30, T.5S., R.26E.  
GRAHAM COUNTY, ARIZONA

ALL CLAIMS ARE 1450' IN LENGTH AND  
600' IN WIDTH UNLESS NOTED

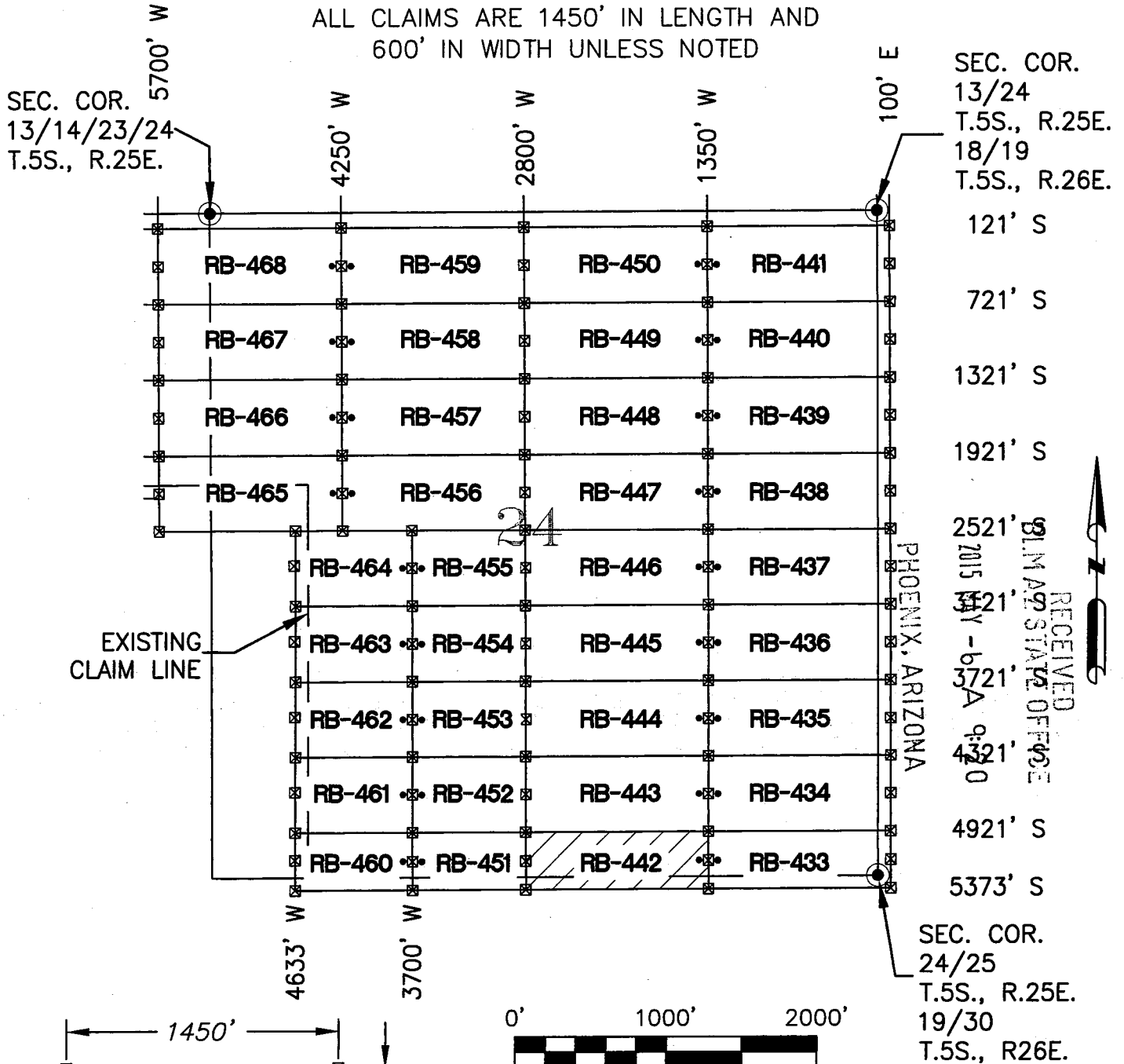

EXISTING CLAIM LINE

PHOENIX, ARIZONA

SEC. COR.  
13/24  
T.5S., R.25E.  
18/19  
T.5S., R.26E.  
121' S  
721' S  
1321' S  
1921' S  
2521' S  
3121' S  
3721' S  
4321' S  
4921' S  
5373' S  
SEC. COR.  
24/25  
T.5S., R.25E.  
19/30  
T.5S., R.26E.

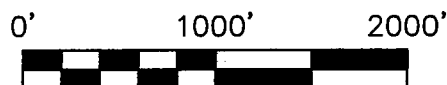
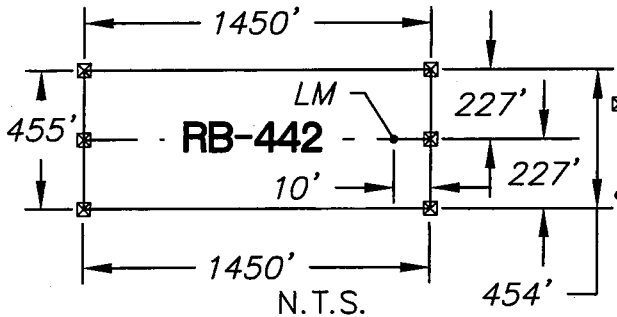

INDICATES CORNER OF LODE CLAIM.  
SET 2"x2"x5' WOODEN POST (TYPICAL)

INDICATES LOCATION  
MONUMENT. SET 2"x2"x5'  
WOODEN POST WITH SIGN  
(TYPICAL)

CLAIM ACREAGE = 15.1 AC  
WC = WITNESS CORNER NORTH  
OF SIDE LINE

LOCATORS:  
FREEPORT MINERALS CORP.  
PO BOX 1019  
SAFFORD AZ 85548

**Entellus™**  
2255 N. 44th Street Suite 125  
Phoenix, AZ 85008.3279  
Tel 602.244.2566  
Fax 602.244.8947  
Website: www.Entellus.com

RECEIVED  
BLM ARIZONA STATE OFFICE  
MAY - 6 2015  
9:42 AM



LOCATION NOTICE FOR LODE MINING CLAIM

Amendment BLM Serial # \_\_\_\_\_

NOTICE IS HEREBY GIVEN that the Red Bull - 443

\_\_\_\_\_ lode mining claim has been located  
by Freeport Minerals Corporation whose current mailing  
address is P.O. Box 1019  
Safford, Arizona 85548

RECEIVED  
BLM AZ STATE OFFICE  
2015 MAY -6 A 9:20  
PHOENIX, ARIZONA  
BLM  
Date  
Stamp

The general course of this claim is East To West and it is situated in Graham  
County, Arizona. This claim is 1450 feet in length and 600 feet in width.

20.0 Total Claim Acreage. This claim runs from the location monument on which this location notice  
is posted on the centerline of the claim approximately 10 feet in a Easterly direction to the East  
end line and 1440 feet in a Westerly direction to the West end line. This claim is marked by six  
monuments, one at each corner and one at the center of each end line of the claim.

The location monument on which this notice is posted is situated within Section 24 Township 5  
S, Range 25 E, Gila Salt River Base and Meridian, Arizona and this claim encompasses portions  
of the following quarter section(s), section(s), Township(s) and Range(s) SE 1/4 and SW 1/4

Section 24 Township 5S Range 25E  
Gila Salt River Base and Meridian, Arizona.

The locality of this claim with reference to some natural object or permanent monument and additional information  
(if any) concerning its locality are as follows: The Northeast corner of the claim is 4321' South and 1350' West of the monument at the  
Northeast Corner of Section 24, Township 5S, Range 25E

The above information is shown on the attached map.

DATED AND POSTED on the ground this 7 day of April, 2015.

LOCATOR(s)  AGENT

Print Name(s) Entellus, Inc. - Daniel G. Francetic, RLS

Signature(s) *Daniel G. Francetic*

Form MCF100  
Revised July 2014

ANCI 32148

# RED BULL - 443 CLAIM

## LOCATION OF RED BULL-433 THROUGH RED BULL-468 LODE CLAIMS

LOCATED IN SECTIONS 23, 24, & 25 T.5S., R.25E., SECTIONS 19 & 30, T.5S., R.26E.  
GRAHAM COUNTY, ARIZONA

ALL CLAIMS ARE 1450' IN LENGTH AND  
600' IN WIDTH UNLESS NOTED

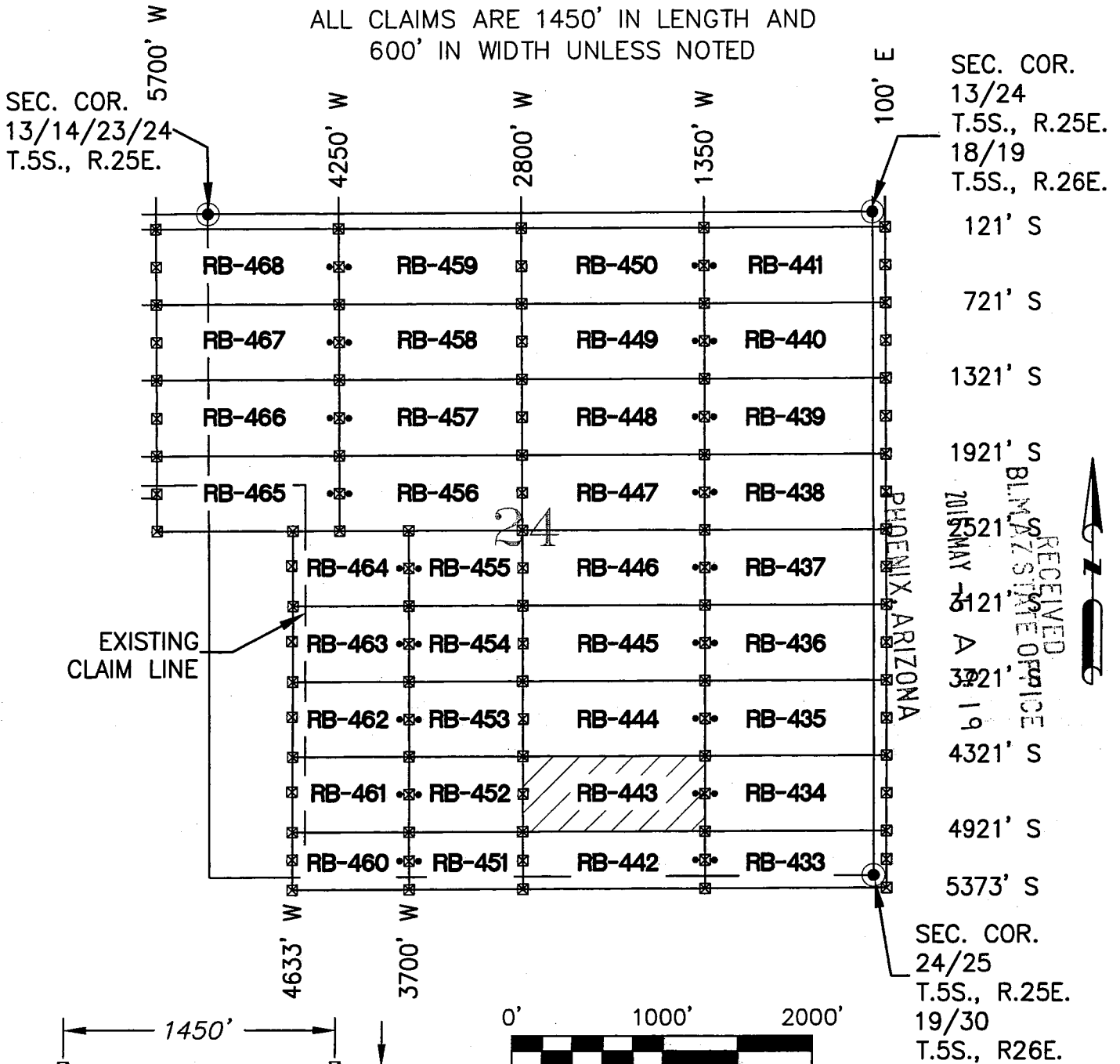

RECEIVED  
 BLM'S STATE OFFICE  
 2015 MAY 19

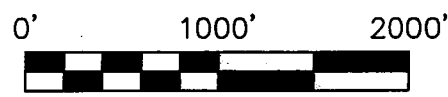
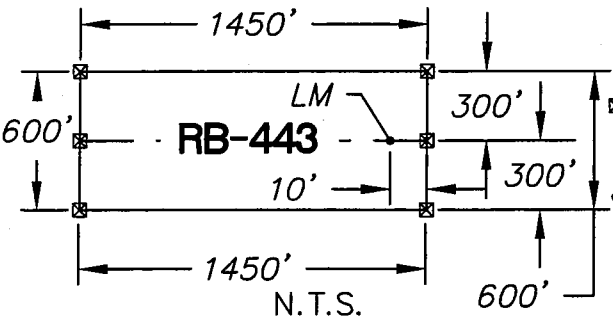

- ☒ INDICATES CORNER OF LODE CLAIM. SET 2"x2"x5' WOODEN POST (TYPICAL)
- INDICATES LOCATION MONUMENT. SET 2"x2"x5' WOODEN POST WITH SIGN (TYPICAL)

LOCATORS:  
 FREEPORT MINERALS CORP.  
 PO BOX 1019  
 SAFFORD AZ 85548

CLAIM ACREAGE = 20.0 AC  
 WC = WITNESS CORNER NORTH  
 OF SIDE LINE

**Entellus™**  
 2255 N. 44th Street Suite 125  
 Phoenix, AZ 85008.3279  
 Tel 602.244.2566  
 Fax 602.244.8947  
 Website: www.Entellus.com

LOCATION NOTICE FOR LODE MINING CLAIM

Amendment BLM Serial # \_\_\_\_\_

NOTICE IS HEREBY GIVEN that the Red Bull - 444

\_\_\_\_\_ lode mining claim has been located  
by Freeport Minerals Corporation whose current mailing  
address is P.O. Box 1019  
Safford, Arizona 85548

RECEIVED  
BLM AZ STATE OFFICE  
2015 MAY -6 A 9:19  
PHOENIX, ARIZONA  
BLM  
Date  
Stamp

The general course of this claim is East To West and it is situated in Graham  
County, Arizona. This claim is 1450 feet in length and 600 feet in width.

20.0 Total Claim Acreage. This claim runs from the location monument on which this location notice  
is posted on the centerline of the claim approximately 10 feet in a Easterly direction to the East  
end line and 1440 feet in a Westerly direction to the West end line. This claim is marked by six  
monuments, one at each corner and one at the center of each end line of the claim.

The location monument on which this notice is posted is situated within Section 24 Township 5  
S, Range 25 E, Gila Salt River Base and Meridian, Arizona and this claim encompasses portions  
of the following quarter section(s), section(s), Township(s) and Range(s) SE 1/4 and SW 1/4

Section 24 Township 5S Range 25E  
Gila Salt River Base and Meridian, Arizona.

The locality of this claim with reference to some natural object or permanent monument and additional information  
(if any) concerning its locality are as follows: The Northeast corner of the claim is 3721' South and 1350' West of the monument at the  
Northeast Corner of Section 24, Township 5S, Range 25E

The above information is shown on the attached map.

DATED AND POSTED on the ground this 7 day of April, 2015.

LOCATOR(s)  AGENT

Print Name(s) Entellus, Inc. - Daniel G. Francetic, RLS

Signature(s) *Daniel G. Francetic*

Form MCF100  
Revised July 2014

AMC432149

# RED BULL - 444 CLAIM

## LOCATION OF RED BULL-433 THROUGH RED BULL-468 LODE CLAIMS

LOCATED IN SECTIONS 23, 24, & 25 T.5S., R.25E., SECTIONS 19 & 30, T.5S., R.26E.  
GRAHAM COUNTY, ARIZONA

ALL CLAIMS ARE 1450' IN LENGTH AND  
600' IN WIDTH UNLESS NOTED

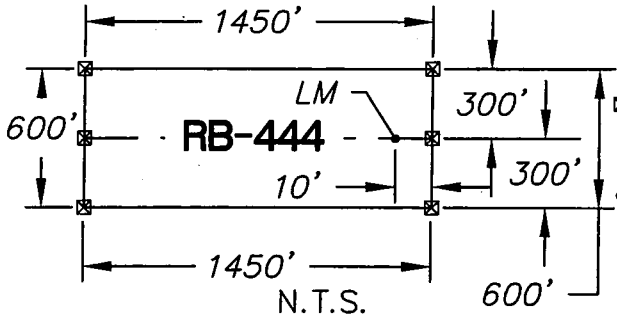
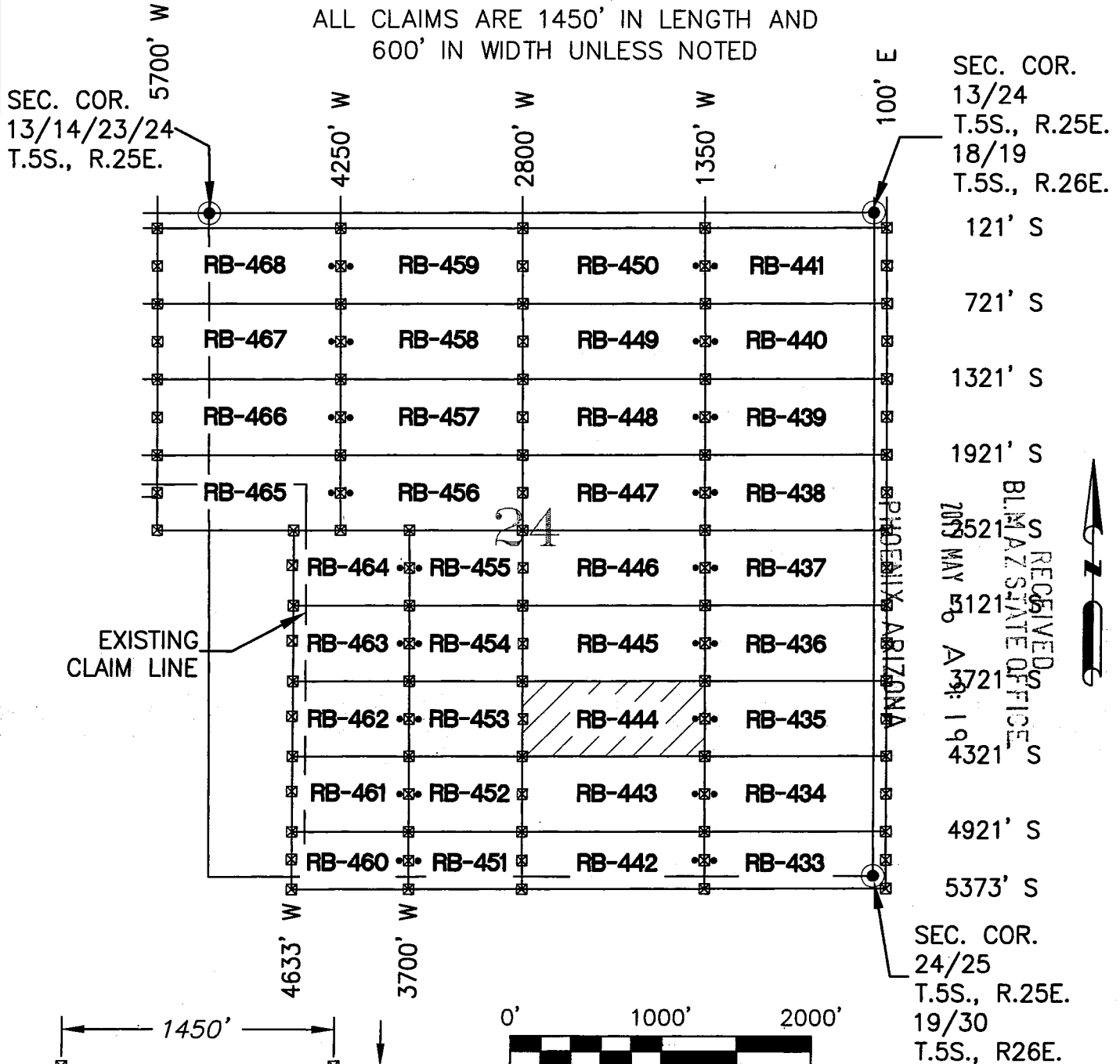

INDICATES CORNER OF LODE CLAIM.  
SET 2"x2"x5' WOODEN POST (TYPICAL)

INDICATES LOCATION  
MONUMENT. SET 2"x2"x5'  
WOODEN POST WITH SIGN  
(TYPICAL)

LOCATORS:  
FREEPORT MINERALS CORP.  
PO BOX 1019  
SAFFORD AZ 85548

CLAIM ACREAGE = 20.0 AC  
WC = WITNESS CORNER NORTH  
OF SIDE LINE

**Entellus™**  
2255 N. 44th Street Suite 125  
Phoenix, AZ 85008.3279  
Tel 602.244.2566  
Fax 602.244.8947  
Website: www.Entellus.com

LOCATION NOTICE FOR LODE MINING CLAIM

Amendment BLM Serial # \_\_\_\_\_

NOTICE IS HEREBY GIVEN that the Red Bull - 445

\_\_\_\_\_ lode mining claim has been located

by Freeport Minerals Corporation whose current mailing

address is P.O. Box 1019

Safford, Arizona 85548

RECEIVED  
BLM AZ STATE OFFICE  
2015 MAY -6 A 9:19  
PHOENIX, ARIZONA  
BLM  
Date  
Stamp

The general course of this claim is East To West and it is situated in Graham

County, Arizona. This claim is 1450 feet in length and 600 feet in width.

20.0 Total Claim Acreage. This claim runs from the location monument on which this location notice

is posted on the centerline of the claim approximately 10 feet in a Easterly direction to the East

end line and 1440 feet in a Westerly direction to the West end line. This claim is marked by six

monuments, one at each corner and one at the center of each end line of the claim.

The location monument on which this notice is posted is situated within Section 24 Township 5

S, Range 25 E, Gila Salt River Base and Meridian, Arizona and this claim encompasses portions

of the following quarter section(s), section(s), Township(s) and Range(s) SE 1/4 and SW 1/4

Section 24 Township 5S Range 25E

Gila Salt River Base and Meridian, Arizona.

The locality of this claim with reference to some natural object or permanent monument and additional information

(if any) concerning its locality are as follows: The Northeast corner of the claim is 3121' South and 1350' West of the monument at the

Northeast Corner of Section 24, Township 5S, Range 25E

The above information is shown on the attached map.

DATED AND POSTED on the ground this 7 day of April, 2015

LOCATOR(s)  AGENT

Print Name(s) Entellus, Inc. - Daniel G. Francetic, RLS

Signature(s) *Daniel G. Francetic*

Form MCF100  
Revised July 2014

AMC432150



# RED BULL - 445 CLAIM

## LOCATION OF RED BULL-433 THROUGH RED BULL-468 LODE CLAIMS

LOCATED IN SECTIONS 23, 24, & 25 T.5S., R.25E., SECTIONS 19 & 30, T.5S., R.26E.  
GRAHAM COUNTY, ARIZONA

ALL CLAIMS ARE 1450' IN LENGTH AND  
600' IN WIDTH UNLESS NOTED

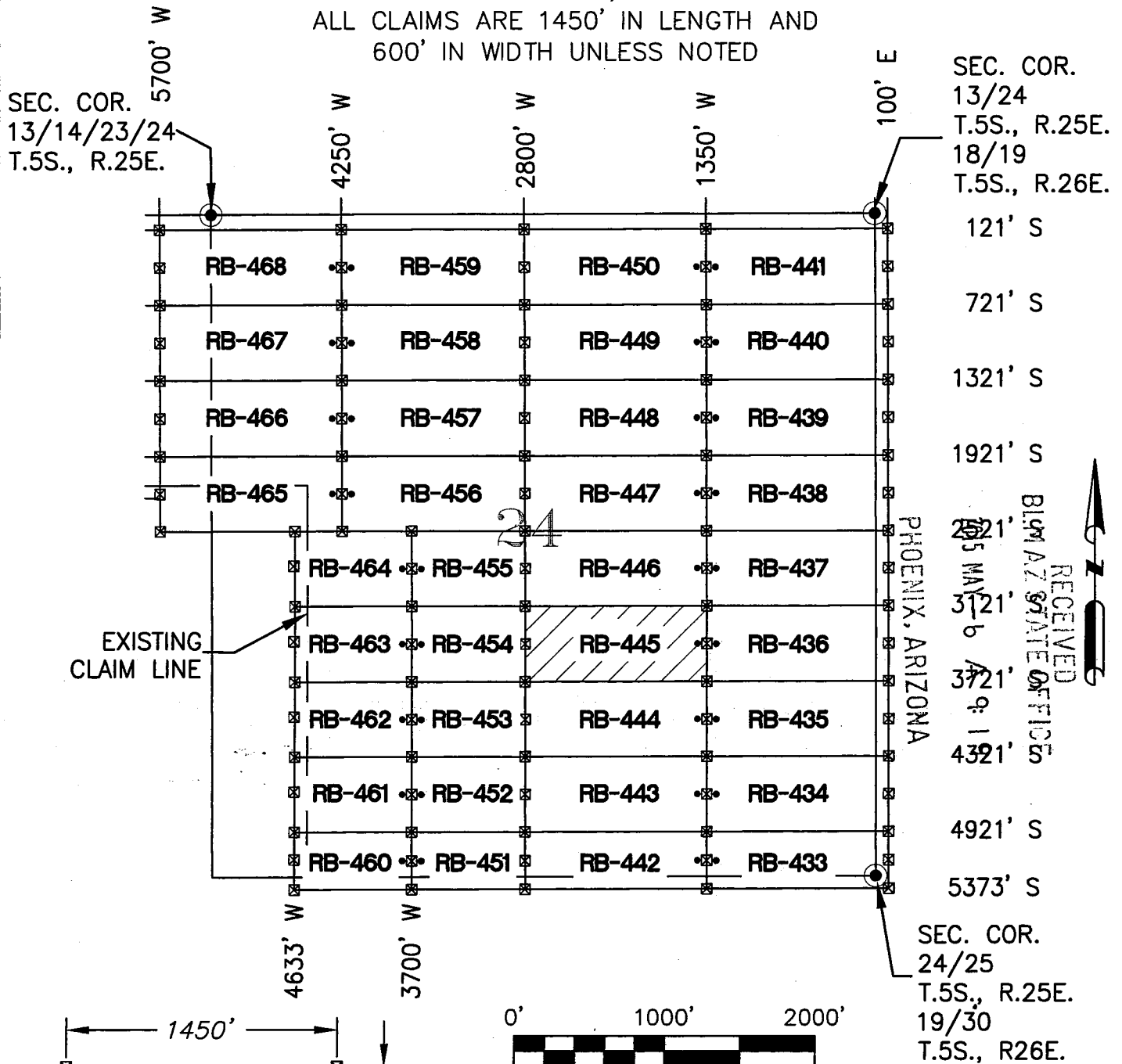

SEC. COR.  
13/24  
T.5S., R.25E.  
18/19  
T.5S., R.26E.

121' S

721' S

1321' S

1921' S

2521' S

3121' S

3721' S

4321' S

4921' S

5373' S

SEC. COR.  
24/25  
T.5S., R.25E.  
19/30  
T.5S., R.26E.

RECEIVED  
BLM AZ STATE OFFICES  
MAY 6 9 1



EXISTING CLAIM LINE

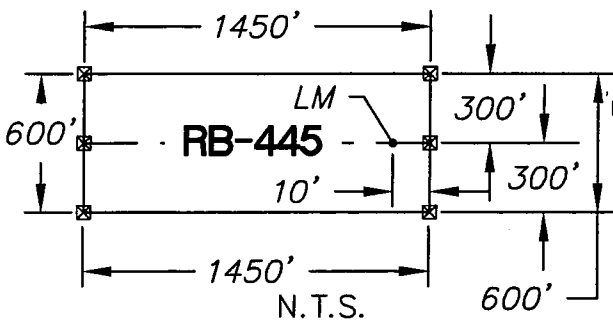

0' 1000' 2000'



INDICATES CORNER OF LODE CLAIM.  
SET 2"x2"x5' WOODEN POST (TYPICAL)

INDICATES LOCATION  
MONUMENT. SET 2"x2"x5'  
WOODEN POST WITH SIGN  
(TYPICAL)

LOCATORS:  
FREEMINERALS CORP.  
PO BOX 1019  
SAFFORD AZ 85548

CLAIM ACREAGE = 20.0 AC  
WC = WITNESS CORNER NORTH  
OF SIDE LINE

 **Entellus™**  
2255 N. 44th Street Suite 125  
Phoenix, AZ 85008.3279  
Tel 602.244.2566  
Fax 602.244.8947  
Website: www.Entellus.com

LOCATION NOTICE FOR LODE MINING CLAIM

Amendment BLM Serial # \_\_\_\_\_

NOTICE IS HEREBY GIVEN that the Red Bull - 446

\_\_\_\_\_ lode mining claim has been located  
by Freeport Minerals Corporation whose current mailing  
address is P.O. Box 1019  
Safford, Arizona 85548

RECEIVED  
BLM AZ STATE OFFICE  
PHOENIX, ARIZONA  
2015 MAY -6 A 9:19  
BLM  
Date  
Stamp

The general course of this claim is East To West and it is situated in Graham  
County, Arizona. This claim is 1450 feet in length and 600 feet in width.

20.0 Total Claim Acreage. This claim runs from the location monument on which this location notice  
is posted on the centerline of the claim approximately 10 feet in a Easterly direction to the East  
end line and 1440 feet in a Westerly direction to the West end line. This claim is marked by six  
monuments, one at each corner and one at the center of each end line of the claim.

The location monument on which this notice is posted is situated within Section 24 Township 5  
S, Range 25 E, Gila Salt River Base and Meridian, Arizona and this claim encompasses portions  
of the following quarter section(s), section(s), Township(s) and Range(s) SE 1/4, SW 1/4, NE 1/4 and NW 1/4

Section 24 Township 5S Range 25E  
Gila Salt River Base and Meridian, Arizona.

The locality of this claim with reference to some natural object or permanent monument and additional information  
(if any) concerning its locality are as follows: The Northeast corner of the claim is 2521' South and 1350' West of the monument at the  
Northeast Corner of Section 24, Township 5S, Range 25E

The above information is shown on the attached map.

DATED AND POSTED on the ground this 7 day of April, 2015

LOCATOR(s)  AGENT

Print Name(s) Entellus, Inc. - Daniel G. Francetic, RLS

Signature(s) *Daniel G. Francetic*

Form MCF100  
Revised July 2014

AMC4321511

# RED BULL - 446 CLAIM

## LOCATION OF RED BULL-433 THROUGH RED BULL-468 LODE CLAIMS

LOCATED IN SECTIONS 23, 24, & 25 T.5S., R.25E., SECTIONS 19 & 30, T.5S., R.26E.  
GRAHAM COUNTY, ARIZONA

ALL CLAIMS ARE 1450' IN LENGTH AND  
600' IN WIDTH UNLESS NOTED

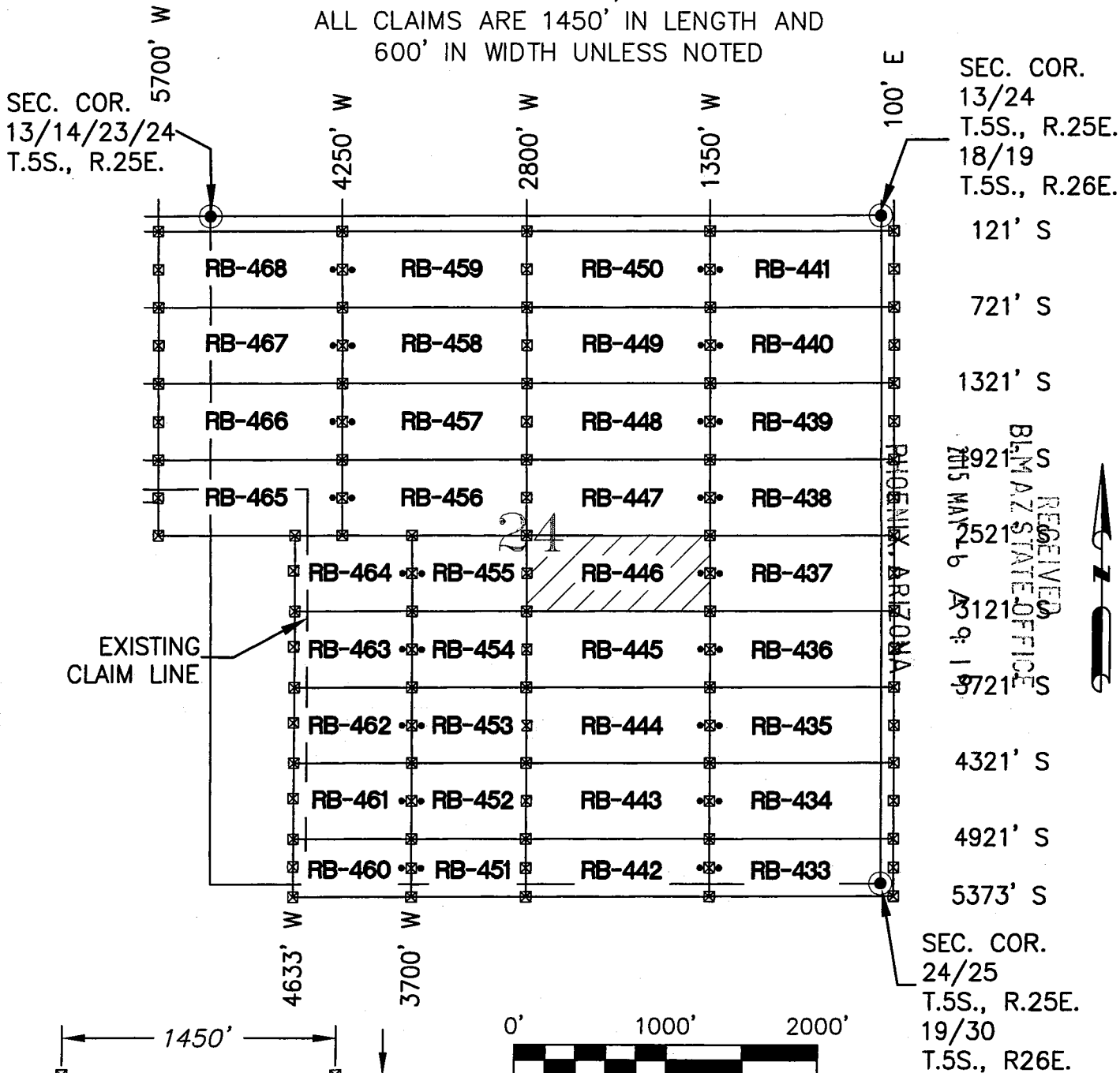

EXISTING CLAIM LINE

RECEIVED  
 BLM AZ STATE OFFICE  
 THIS MAY 16 AM 9:16  
 1992

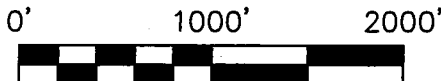
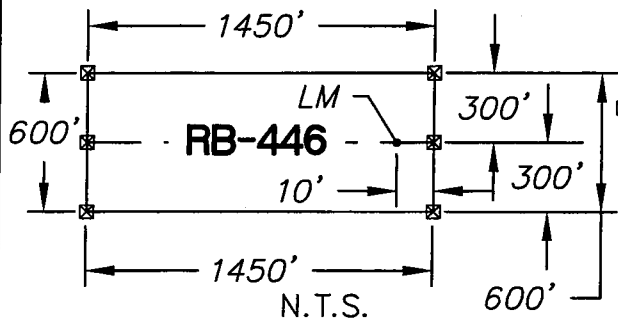

- ☒ INDICATES CORNER OF LODE CLAIM. SET 2"x2"x5' WOODEN POST (TYPICAL)
- INDICATES LOCATION MONUMENT. SET 2"x2"x5' WOODEN POST WITH SIGN (TYPICAL)

LOCATORS:  
 FREEPORT MINERALS CORP.  
 PO BOX 1019  
 SAFFORD AZ 85548

CLAIM ACREAGE = 20.0 AC  
 WC = WITNESS CORNER NORTH  
 OF SIDE LINE

**Entellus™**  
 2255 N. 44th Street Suite 125  
 Phoenix, AZ 85008.3279  
 Tel 602.244.2566  
 Fax 602.244.8947  
 Website: www.Entellus.com

LOCATION NOTICE FOR LODE MINING CLAIM

Amendment BLM Serial # \_\_\_\_\_

NOTICE IS HEREBY GIVEN that the Red Bull - 447

\_\_\_\_\_ lode mining claim has been located  
by Freeport Minerals Corporation whose current mailing  
address is P.O. Box 1019  
Safford, Arizona 85548

RECEIVED  
BLM AZ STATE OFFICE  
2015 MAY -6 A 9:19  
PHOENIX, ARIZONA  
BLM  
Date  
Stamp

The general course of this claim is East To West and it is situated in Graham

County, Arizona. This claim is 1450 feet in length and 600 feet in width.

20.0 Total Claim Acreage. This claim runs from the location monument on which this location notice

is posted on the centerline of the claim approximately 10 feet in a Easterly direction to the East  
end line and 1440 feet in a Westerly direction to the West end line. This claim is marked by six  
monuments, one at each corner and one at the center of each end line of the claim.

The location monument on which this notice is posted is situated within Section 24 Township 5

S, Range 25 E, Gila Salt River Base and Meridian, Arizona and this claim encompasses portions

of the following quarter section(s), section(s), Township(s) and Range(s) NE 1/4 and NW 1/4

Section 24 Township 5S Range 25E

Gila Salt River Base and Meridian, Arizona.

The locality of this claim with reference to some natural object or permanent monument and additional information

(if any) concerning its locality are as follows: The Northeast corner of the claim is 1921' South and 1350' West of the monument at the

Northeast Corner of Section 24, Township 5S, Range 25E

The above information is shown on the attached map.

DATED AND POSTED on the ground this 7 day of April, 2015

LOCATOR(s)  AGENT

Print Name(s) Entellus, Inc. - Daniel G. Francetic, RLS

Signature(s) *Daniel G. Francetic*

Form MCF100  
Revised July 2014

AMC4321521

# RED BULL - 447 CLAIM

## LOCATION OF RED BULL-433 THROUGH RED BULL-468 LODE CLAIMS

LOCATED IN SECTIONS 23, 24, & 25 T.5S., R.25E., SECTIONS 19 & 30, T.5S., R.26E.  
GRAHAM COUNTY, ARIZONA

ALL CLAIMS ARE 1450' IN LENGTH AND  
600' IN WIDTH UNLESS NOTED

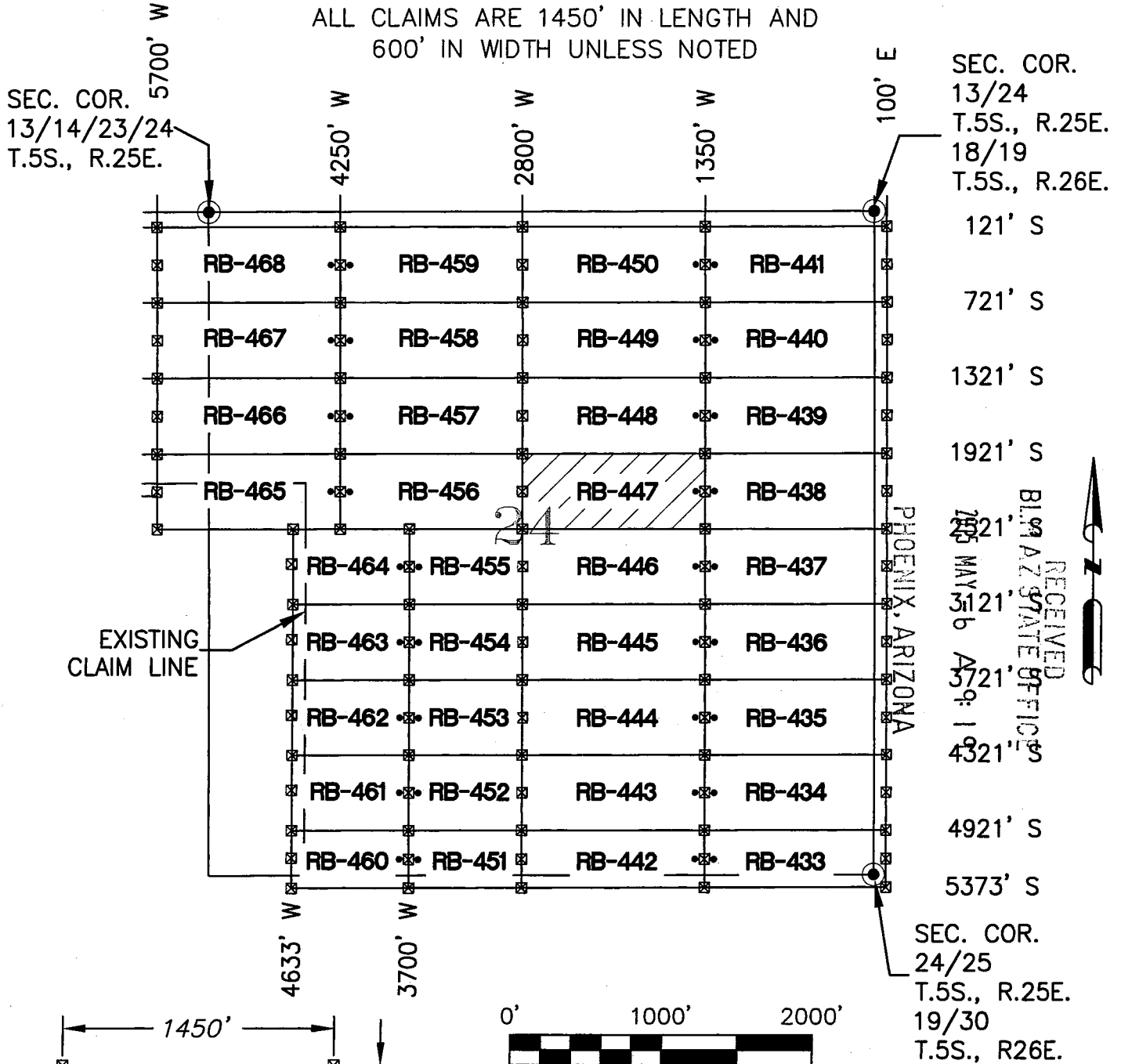

EXISTING CLAIM LINE

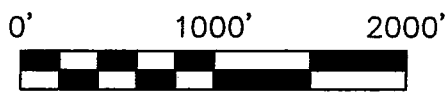
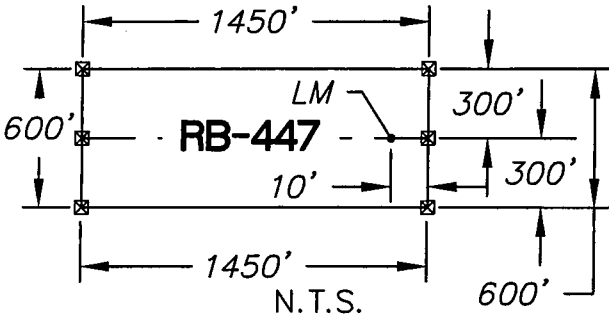

- ☒ INDICATES CORNER OF LODE CLAIM. SET 2"x2"x5' WOODEN POST (TYPICAL)
- INDICATES LOCATION MONUMENT. SET 2"x2"x5' WOODEN POST WITH SIGN (TYPICAL)

LOCATORS:  
FREEPORT MINERALS CORP.  
PO BOX 1019  
SAFFORD AZ 85548

CLAIM ACREAGE = 20.0 AC  
WC = WITNESS CORNER NORTH  
OF SIDE LINE

**Entellus™**  
2255 N. 44th Street Suite 125  
Phoenix, AZ 85008.3279  
Tel 602.244.2566  
Fax 602.244.8947  
Website: www.Entellus.com

RECEIVED  
BLM AZ STATE OFFICE  
2005 MAY 15 6 49 1  
PHOENIX, ARIZONA

LOCATION NOTICE FOR LODE MINING CLAIM

Amendment BLM Serial # \_\_\_\_\_

NOTICE IS HEREBY GIVEN that the Red Bull - 448

\_\_\_\_\_ lode mining claim has been located  
by Freeport Minerals Corporation whose current mailing  
address is P.O. Box 1019  
Safford, Arizona 85548

RECEIVED  
BLM AZ STATE OFFICE  
2015 MAY -6 A 9:19  
PHOENIX, ARIZONA  
BLM  
Date  
Stamp

The general course of this claim is East To West and it is situated in Graham

County, Arizona. This claim is 1450 feet in length and 600 feet in width.

20.0 Total Claim Acreage. This claim runs from the location monument on which this location notice

is posted on the centerline of the claim approximately 10 feet in a Easterly direction to the East

end line and 1440 feet in a Westerly direction to the West end line. This claim is marked by six  
monuments, one at each corner and one at the center of each end line of the claim.

The location monument on which this notice is posted is situated within Section 24 Township 5  
S, Range 25 E, Gila Salt River Base and Meridian, Arizona and this claim encompasses portions

of the following quarter section(s), section(s), Township(s) and Range(s) NE 1/4 and NW 1/4

Section 24 Township 5S Range 25E

Gila Salt River Base and Meridian, Arizona.

The locality of this claim with reference to some natural object or permanent monument and additional information

(if any) concerning its locality are as follows: The Northeast corner of the claim is 1321' South and 1350' West of the monument at the

Northeast Corner of Section 24, Township 5S, Range 25E

The above information is shown on the attached map.

DATED AND POSTED on the ground this 7 day of April, 2015

LOCATOR(s)  AGENT

Print Name(s) Entellus, Inc. - Daniel G. Francetic, RLS

Signature(s) *Daniel G. Francetic*

Form MCF100  
Revised July 2014

AMC432153

# RED BULL - 448 CLAIM

## LOCATION OF RED BULL-433 THROUGH RED BULL-468 LODE CLAIMS

LOCATED IN SECTIONS 23, 24, & 25 T.5S., R.25E., SECTIONS 19 & 30, T.5S., R.26E.  
GRAHAM COUNTY, ARIZONA

ALL CLAIMS ARE 1450' IN LENGTH AND  
600' IN WIDTH UNLESS NOTED

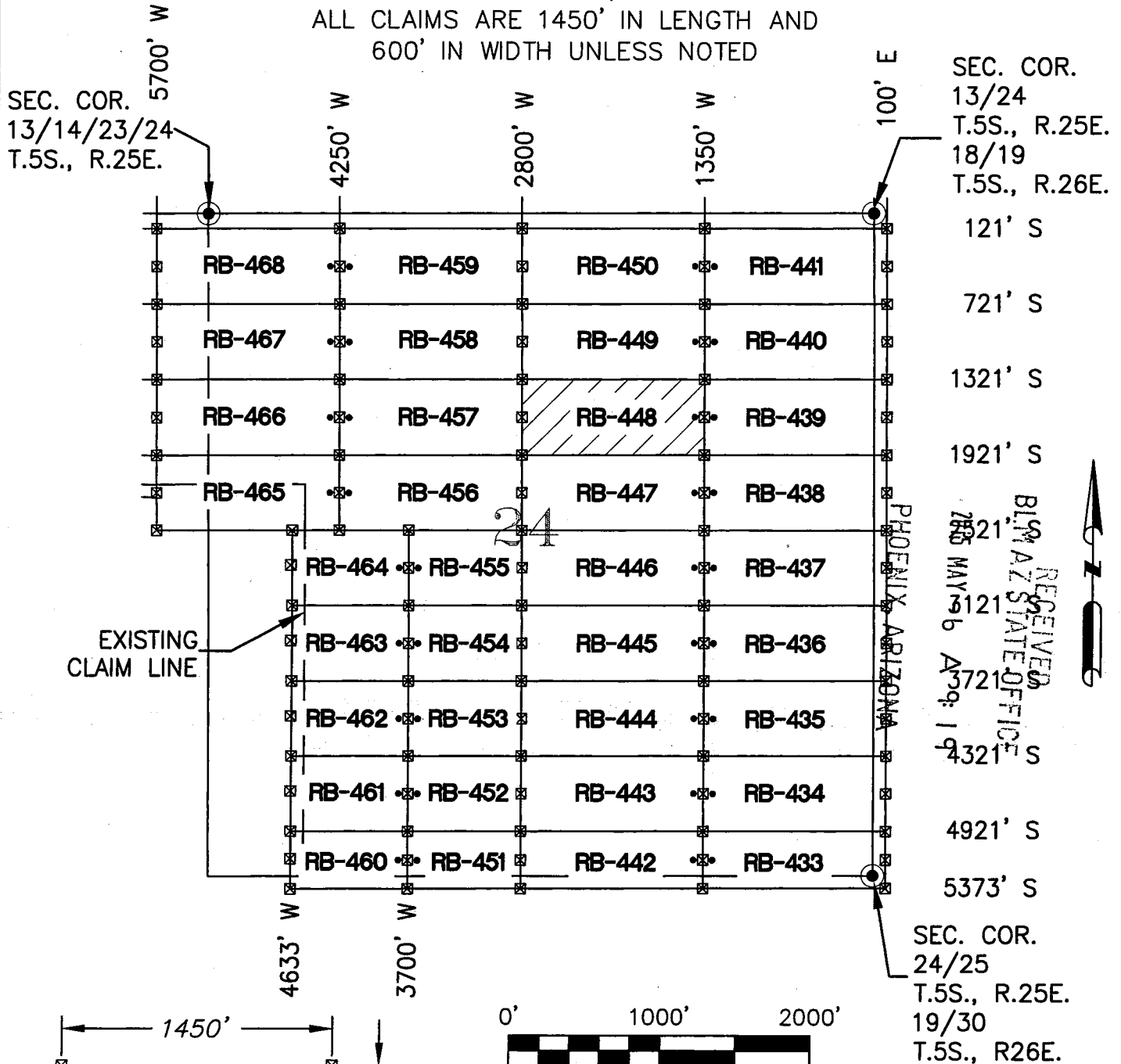

EXISTING CLAIM LINE

SEC. COR.  
13/24  
T.5S., R.25E.  
18/19  
T.5S., R.26E.  
121' S  
721' S  
1321' S  
1921' S  
2521' S  
3121' S  
3721' S  
4321' S  
4921' S  
5373' S  
SEC. COR.  
24/25  
T.5S., R.25E.  
19/30  
T.5S., R.26E.

RECEIVED  
BLM AZ STATE OFFICE  
MAY 9 9 37 21  
APR 1 9 43 21

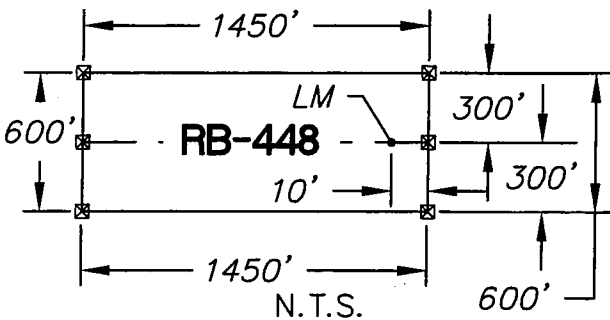

- ☒ INDICATES CORNER OF LODE CLAIM. SET 2"x2"x5' WOODEN POST (TYPICAL)
- INDICATES LOCATION MONUMENT. SET 2"x2"x5' WOODEN POST WITH SIGN (TYPICAL)

LOCATORS:  
FREEPORT MINERALS CORP.  
PO BOX 1019  
SAFFORD AZ 85548

CLAIM ACREAGE = 20.0 AC  
WC = WITNESS CORNER NORTH  
OF SIDE LINE

 **Entellus™**  
2255 N. 44th Street Suite 125  
Phoenix, AZ 85008.3279  
Tel 602.244.2566  
Fax 602.244.8947  
Website: www.Entellus.com

LOCATION NOTICE FOR LODE MINING CLAIM

Amendment BLM Serial # \_\_\_\_\_

NOTICE IS HEREBY GIVEN that the Red Bull - 449

\_\_\_\_\_ lode mining claim has been located  
by Freeport Minerals Corporation whose current mailing  
address is P.O. Box 1019  
Safford, Arizona 85548

RECEIVED  
BLM AZ STATE OFFICE  
2015 MAY -6 A 9:19  
PHOENIX, ARIZONA  
Graham  
BLM  
Date  
Stamp

The general course of this claim is East To West and it is situated in  
County, Arizona. This claim is 1450 feet in length and 600 feet in width.

20.0 Total Claim Acreage. This claim runs from the location monument on which this location notice  
is posted on the centerline of the claim approximately 10 feet in a Easterly direction to the East  
end line and 1440 feet in a Westerly direction to the West end line. This claim is marked by six  
monuments, one at each corner and one at the center of each end line of the claim.

The location monument on which this notice is posted is situated within Section 24 Township 5  
S, Range 25 E, Gila Salt River Base and Meridian, Arizona and this claim encompasses portions  
of the following quarter section(s), section(s), Township(s) and Range(s) NE 1/4 and NW 1/4

Section 24 Township 5S Range 25E

Gila Salt River Base and Meridian, Arizona.

The locality of this claim with reference to some natural object or permanent monument and additional information  
(if any) concerning its locality are as follows: The Northeast corner of the claim is 721' South and 1350' West of the monument at the  
Northeast Corner of Section 24, Township 5S, Range 25E

The above information is shown on the attached map.

DATED AND POSTED on the ground this 7 day of April, 2015

LOCATOR(s)  AGENT

Print Name(s) Entellus, Inc. - Daniel G. Francetic, RLS

Signature(s) *Daniel G. Francetic*

Form MCF100  
Revised July 2014

AMC 432154



# RED BULL - 449 CLAIM

## LOCATION OF RED BULL-433 THROUGH RED BULL-468 LODE CLAIMS

LOCATED IN SECTIONS 23, 24, & 25 T.5S., R.25E., SECTIONS 19 & 30, T.5S., R.26E.  
GRAHAM COUNTY, ARIZONA

ALL CLAIMS ARE 1450' IN LENGTH AND  
600' IN WIDTH UNLESS NOTED

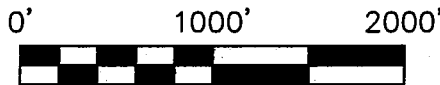
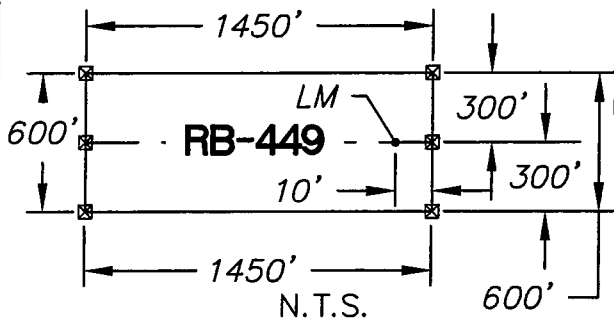
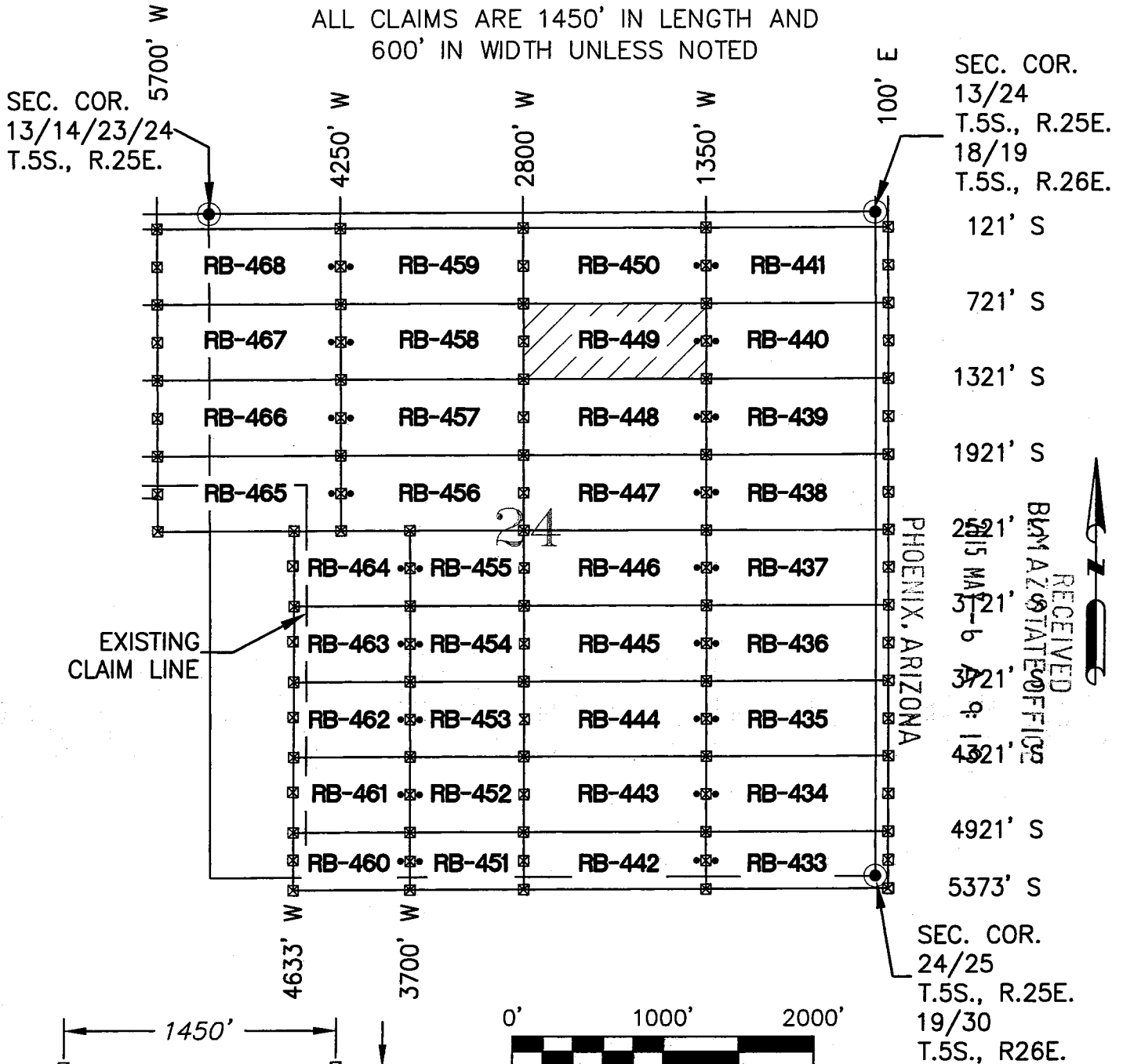

INDICATES CORNER OF LODE CLAIM.  
SET 2"x2"x5' WOODEN POST (TYPICAL)

INDICATES LOCATION  
MONUMENT. SET 2"x2"x5'  
WOODEN POST WITH SIGN  
(TYPICAL)

LOCATORS:  
FREEPORT MINERALS CORP.  
PO BOX 1019  
SAFFORD AZ 85548

CLAIM ACREAGE = 20.0 AC  
WC = WITNESS CORNER NORTH  
OF SIDE LINE

 **Entellus™**  
2255 N. 44th Street Suite 125  
Phoenix, AZ 85008.3279  
Tel 602.244.2566  
Fax 602.244.8947  
Website: www.Entellus.com

LOCATION NOTICE FOR LODE MINING CLAIM

Amendment BLM Serial # \_\_\_\_\_

NOTICE IS HEREBY GIVEN that the Red Bull - 450

\_\_\_\_\_ lode mining claim has been located  
by Freeport Minerals Corporation whose current mailing  
address is P.O. Box 1019  
Safford, Arizona 85548

RECEIVED  
BLM AZ STATE OFFICE  
2015 MAY -6 A 9:19  
PHOENIX, ARIZONA  
BLM  
Date  
Stamp

The general course of this claim is East To West and it is situated in Graham

County, Arizona. This claim is 1450 feet in length and 600 feet in width.

20.0 Total Claim Acreage. This claim runs from the location monument on which this location notice  
is posted on the centerline of the claim approximately 10 feet in a Easterly direction to the East  
end line and 1440 feet in a Westerly direction to the West end line. This claim is marked by six  
monuments, one at each corner and one at the center of each end line of the claim.

The location monument on which this notice is posted is situated within Section 24 Township 5  
S, Range 25 E, Gila Salt River Base and Meridian, Arizona and this claim encompasses portions  
of the following quarter section(s), section(s), Township(s) and Range(s) NE 1/4 and NW 1/4

Section 24 Township 5S Range 25E  
Gila Salt River Base and Meridian, Arizona.

The locality of this claim with reference to some natural object or permanent monument and additional information  
(if any) concerning its locality are as follows: The Northeast corner of the claim is '121' South and 1350' West of the monument at the  
Northeast Corner of Section 24, Township 5S, Range 25E

The above information is shown on the attached map.

DATED AND POSTED on the ground this 7 day of April, 2015.

LOCATOR(s)  AGENT

Print Name(s) Entellus, Inc. - Daniel G. Francetic, RLS

Signature(s) *Daniel G. Francetic*

Form MCF100  
Revised July 2014

AMC432155

# RED BULL - 450 CLAIM

## LOCATION OF RED BULL-433 THROUGH RED BULL-468 LODE CLAIMS

LOCATED IN SECTIONS 23, 24, & 25 T.5S., R.25E., SECTIONS 19 & 30, T.5S., R.26E.  
GRAHAM COUNTY, ARIZONA

ALL CLAIMS ARE 1450' IN LENGTH AND  
600' IN WIDTH UNLESS NOTED

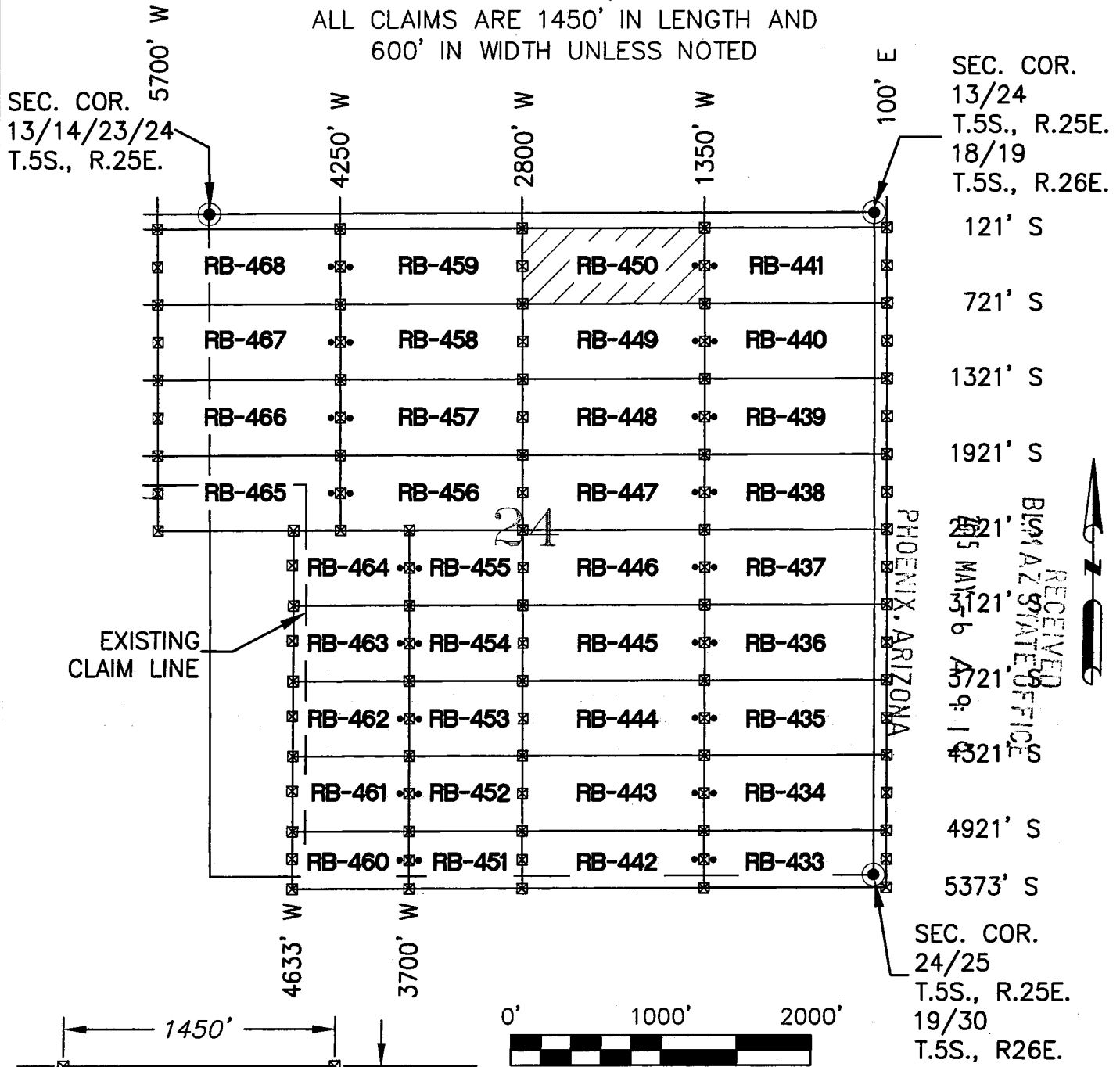

EXISTING CLAIM LINE

RECEIVED  
BUREAU OF LAND MANAGEMENT  
ARIZONA STATE OFFICE  
APR 1 1998

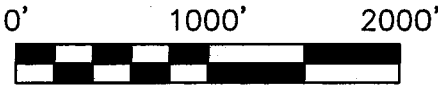
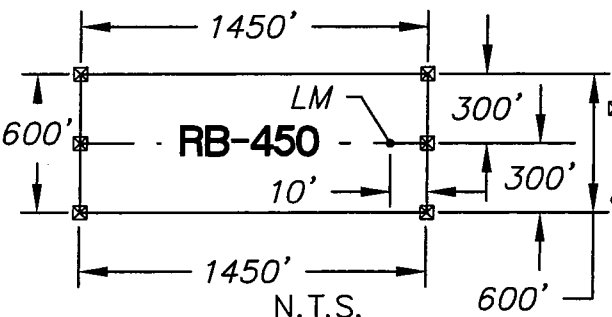

INDICATES CORNER OF LODE CLAIM.  
SET 2"x2"x5' WOODEN POST (TYPICAL)  
INDICATES LOCATION  
MONUMENT. SET 2"x2"x5'  
WOODEN POST WITH SIGN  
(TYPICAL)

SEC. COR.  
24/25  
T.5S., R.25E.  
19/30  
T.5S., R.26E.

LOCATORS:  
FREEPORT MINERALS CORP.  
PO BOX 1019  
SAFFORD AZ 85548

CLAIM ACREAGE = 20.0 AC  
WC = WITNESS CORNER NORTH  
OF SIDE LINE

**Entellus™**  
2255 N. 44th Street Suite 125  
Phoenix, AZ 85008.3279  
Tel 602.244.2566  
Fax 602.244.8947  
Website: www.Entellus.com

LOCATION NOTICE FOR LODE MINING CLAIM

Amendment BLM Serial # \_\_\_\_\_

NOTICE IS HEREBY GIVEN that the Red Bull - 451

\_\_\_\_\_ lode mining claim has been located  
by Freeport Minerals Corporation whose current mailing  
address is P.O. Box 1019  
Safford, Arizona 85548

RECEIVED  
BLM AZ STATE OFFICE  
2015 MAY -6 A 9:19  
PHOENIX, ARIZONA  
BLM  
Date  
Stamp  
Graham

The general course of this claim is East To West and it is situated in \_\_\_\_\_  
County, Arizona. This claim is 900 feet in length and 456 feet in width.

9.4 Total Claim Acreage. This claim runs from the location monument on which this location notice  
is posted on the centerline of the claim approximately 10 feet in a Westerly direction to the West  
end line and 890 feet in a Easterly direction to the East end line. This claim is marked by six  
monuments, one at each corner and one at the center of each end line of the claim.

The location monument on which this notice is posted is situated within Section 24 Township 5  
S, Range 25 E, Gila Salt River Base and Meridian, Arizona and this claim encompasses portions  
of the following quarter section(s), section(s), Township(s) and Range(s) SW 1/4  
Section 24 Township 5S Range 25E and NW 1/4 Section 25 Township 5S Range 25E

Gila Salt River Base and Meridian, Arizona.

The locality of this claim with reference to some natural object or permanent monument and additional information  
(if any) concerning its locality are as follows: The Northeast corner of the claim is 4921' South and 2800' West of the monument at the  
Northeast Corner of Section 24, Township 5S, Range 25E

The above information is shown on the attached map.

DATED AND POSTED on the ground this 8 day of April, 2015

LOCATOR(s)  AGENT

Print Name(s) Entellus, Inc. - Daniel G. Francetic, RLS

Signature(s) *Daniel G. Francetic*

Form MCF100  
Revised July 2014

AMC432156

# RED BULL - 451 CLAIM

## LOCATION OF RED BULL-433 THROUGH RED BULL-468 LODE CLAIMS

LOCATED IN SECTIONS 23, 24, & 25 T.5S., R.25E., SECTIONS 19 & 30, T.5S., R.26E.  
GRAHAM COUNTY, ARIZONA

ALL CLAIMS ARE 1450' IN LENGTH AND  
600' IN WIDTH UNLESS NOTED

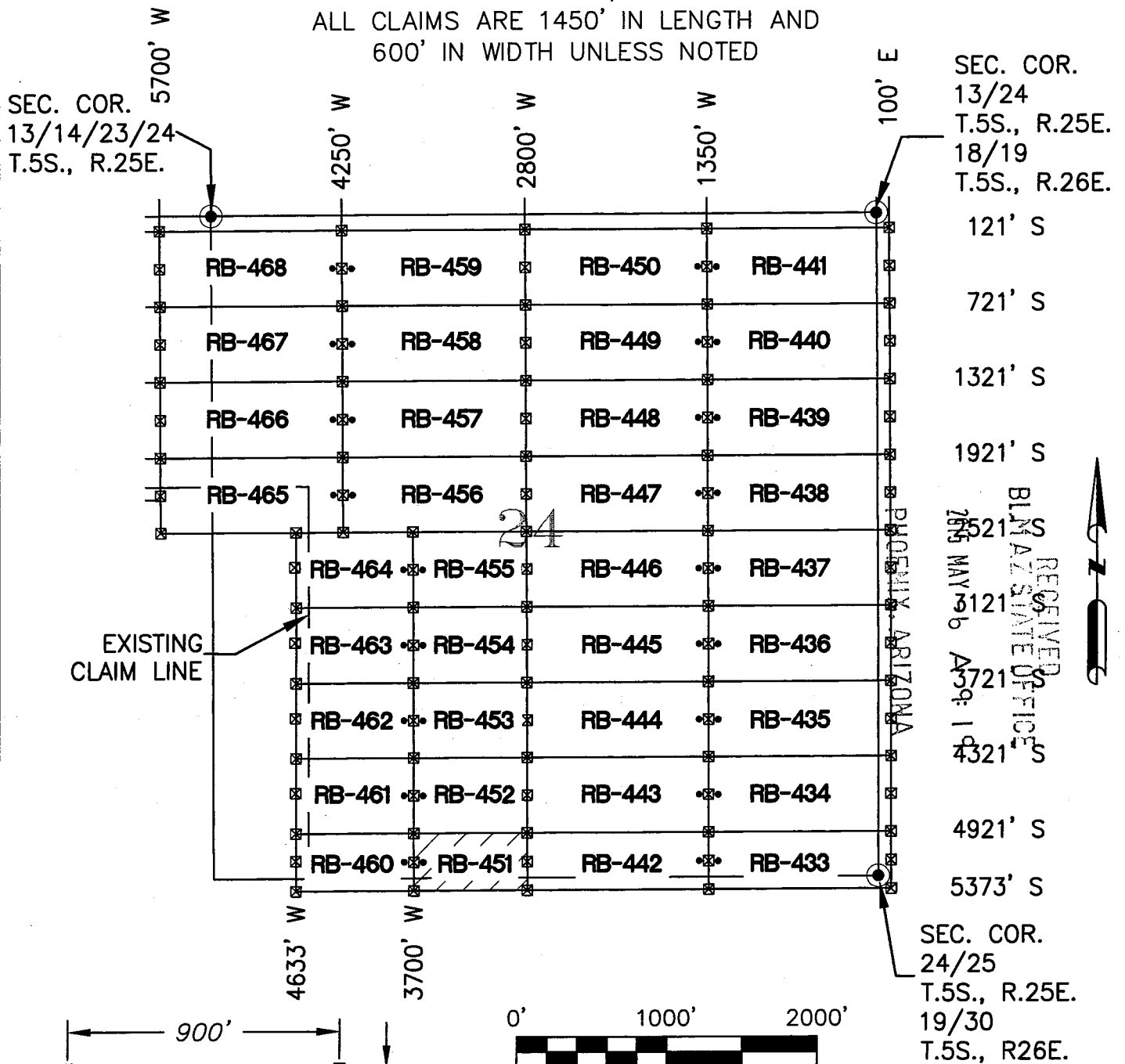

EXISTING CLAIM LINE

RECEIVED  
 BLAZING OFFICE  
 MAY 9 2006  
 AS 9:11 AM

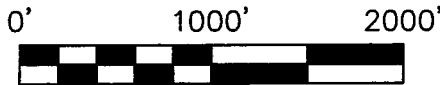
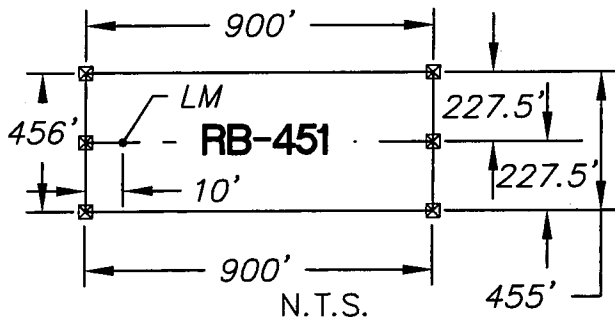

⊠ INDICATES CORNER OF LODE CLAIM.  
 SET 2"x2"x5' WOODEN POST (TYPICAL)  
 • INDICATES LOCATION  
 MONUMENT. SET 2"x2"x5'  
 WOODEN POST WITH SIGN  
 (TYPICAL)

LOCATORS:  
 FREEPORT MINERALS CORP.  
 PO BOX 1019  
 SAFFORD AZ 85548

CLAIM ACREAGE = 9.4 AC  
 WC = WITNESS CORNER NORTH  
 OF SIDE LINE

**Entellus™**  
 2255 N. 44th Street Suite 125  
 Phoenix, AZ 85008.3279  
 Tel 602.244.2566  
 Fax 602.244.8947  
 Website: www.Entellus.com

LOCATION NOTICE FOR LODE MINING CLAIM

Amendment BLM Serial # \_\_\_\_\_

NOTICE IS HEREBY GIVEN that the Red Bull - 452

\_\_\_\_\_ lode mining claim has been located

by Freeport Minerals Corporation whose current mailing

address is P.O. Box 1019

Safford, Arizona 85548

BLM  
Date  
Stamp

RECEIVED  
BLM AZ STATE OFFICE  
2015 MAY - 6 A 9: 8  
PHOENIX, ARIZONA

The general course of this claim is East To West and it is situated in Graham

County, Arizona. This claim is 900 feet in length and 600 feet in width.

12.4 Total Claim Acreage. This claim runs from the location monument on which this location notice

is posted on the centerline of the claim approximately 10 feet in a Westerly direction to the West

end line and 890 feet in a Easterly direction to the East end line. This claim is marked by six

monuments, one at each corner and one at the center of each end line of the claim.

The location monument on which this notice is posted is situated within Section 24 Township 5

S, Range 25 E, Gila Salt River Base and Meridian, Arizona and this claim encompasses portions

of the following quarter section(s), section(s), Township(s) and Range(s) SW 1/4

Section 24 Township 5S Range 25E

Gila Salt River Base and Meridian, Arizona.

The locality of this claim with reference to some natural object or permanent monument and additional information

(if any) concerning its locality are as follows: The Northeast corner of the claim is 4321' South and 2800' West of the monument at the

Northeast Corner of Section 24, Township 5S, Range 25E

The above information is shown on the attached map.

DATED AND POSTED on the ground this 8 day of April, 2015.

LOCATOR(s)  AGENT

Print Name(s) Entellus, Inc. - Daniel G. Francetic, RLS

Signature(s) *Daniel G. Francetic*

Form MCF100  
Revised July 2014

AMC432157

# RED BULL - 452 CLAIM

## LOCATION OF RED BULL-433 THROUGH RED BULL-468 LODE CLAIMS

LOCATED IN SECTIONS 23, 24, & 25 T.5S., R.25E., SECTIONS 19 & 30, T.5S., R.26E.  
GRAHAM COUNTY, ARIZONA

ALL CLAIMS ARE 1450' IN LENGTH AND  
600' IN WIDTH UNLESS NOTED

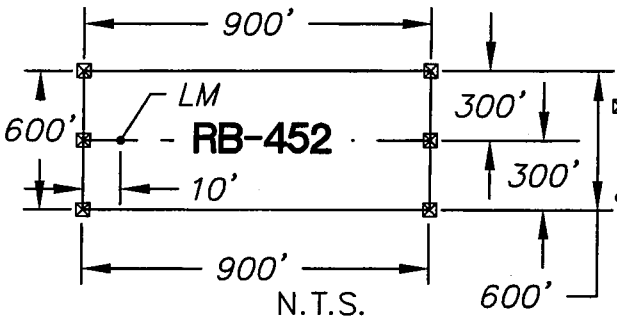
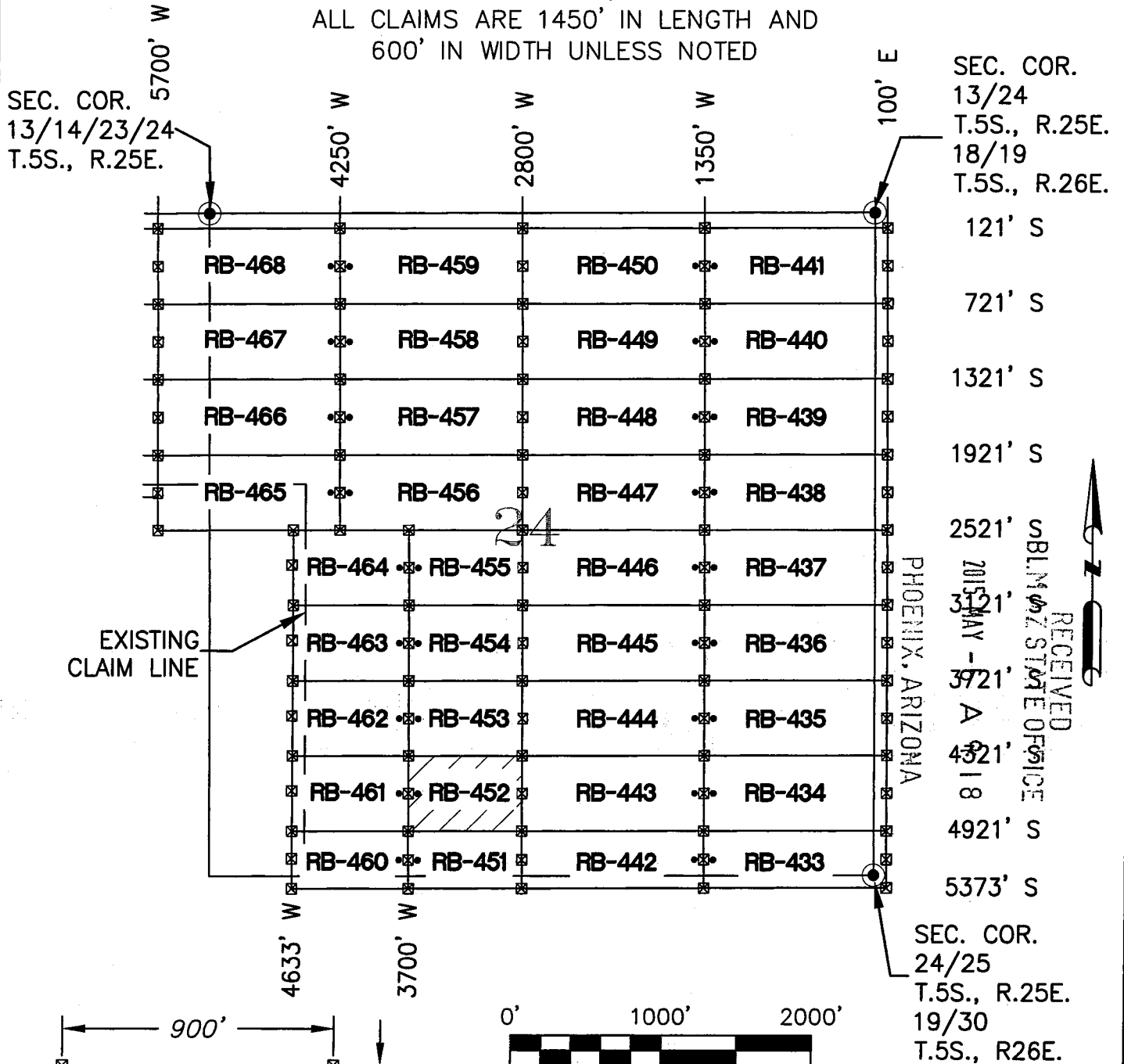

INDICATES CORNER OF LODE CLAIM.  
SET 2"x2"x5' WOODEN POST (TYPICAL)

INDICATES LOCATION  
MONUMENT. SET 2"x2"x5'  
WOODEN POST WITH SIGN  
(TYPICAL)

LOCATORS:  
FREEPORT MINERALS CORP.  
PO BOX 1019  
SAFFORD AZ 85548

CLAIM ACREAGE = 12.4 AC  
WC = WITNESS CORNER NORTH  
OF SIDE LINE

**Entellus™**  
2255 N. 44th Street Suite 125  
Phoenix, AZ 85008.3279  
Tel 602.244.2566  
Fax 602.244.8947  
Website: www.Entellus.com

LOCATION NOTICE FOR LODE MINING CLAIM

Amendment BLM Serial # \_\_\_\_\_

NOTICE IS HEREBY GIVEN that the Red Bull - 453

\_\_\_\_\_ lode mining claim has been located

by Freeport Minerals Corporation whose current mailing

address is P.O. Box 1019

Safford, Arizona 85548

BLM  
Date  
Stamp

PHOENIX, ARIZONA

2015 MAY -6 A 9:18

RECEIVED  
BLM AZ STATE OFFICE

Graham

The general course of this claim is East To West and it is situated in \_\_\_\_\_

County, Arizona. This claim is 900 feet in length and 600 feet in width.

12.4 Total Claim Acreage. This claim runs from the location monument on which this location notice

is posted on the centerline of the claim approximately 10 feet in a Westerly direction to the West

end line and 890 feet in a Easterly direction to the East end line. This claim is marked by six

monuments, one at each corner and one at the center of each end line of the claim.

The location monument on which this notice is posted is situated within Section 24 Township 5

S, Range 25 E, Gila Salt River Base and Meridian, Arizona and this claim encompasses portions

of the following quarter section(s), section(s), Township(s) and Range(s) SW 1/4

Section 24 Township 5S Range 25E

Gila Salt River Base and Meridian, Arizona.

The locality of this claim with reference to some natural object or permanent monument and additional information

(if any) concerning its locality are as follows: The Northeast corner of the claim is 3721' South and 2800' West of the monument at the

Northeast Corner of Section 24, Township 5S, Range 25E

The above information is shown on the attached map.

DATED AND POSTED on the ground this 8 day of April, 2015

LOCATOR(s)  AGENT

Print Name(s) Entellus, Inc. - Daniel G. Francetic, RLS

Signature(s) *Daniel G. Francetic*

Form MCF100  
Revised July 2014

AMC 432158



# RED BULL - 453 CLAIM

## LOCATION OF RED BULL-433 THROUGH RED BULL-468 LODE CLAIMS

LOCATED IN SECTIONS 23, 24, & 25 T.5S., R.25E., SECTIONS 19 & 30, T.5S., R.26E.  
GRAHAM COUNTY, ARIZONA

ALL CLAIMS ARE 1450' IN LENGTH AND  
600' IN WIDTH UNLESS NOTED

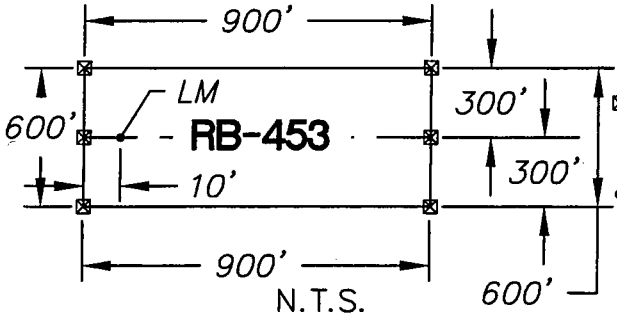
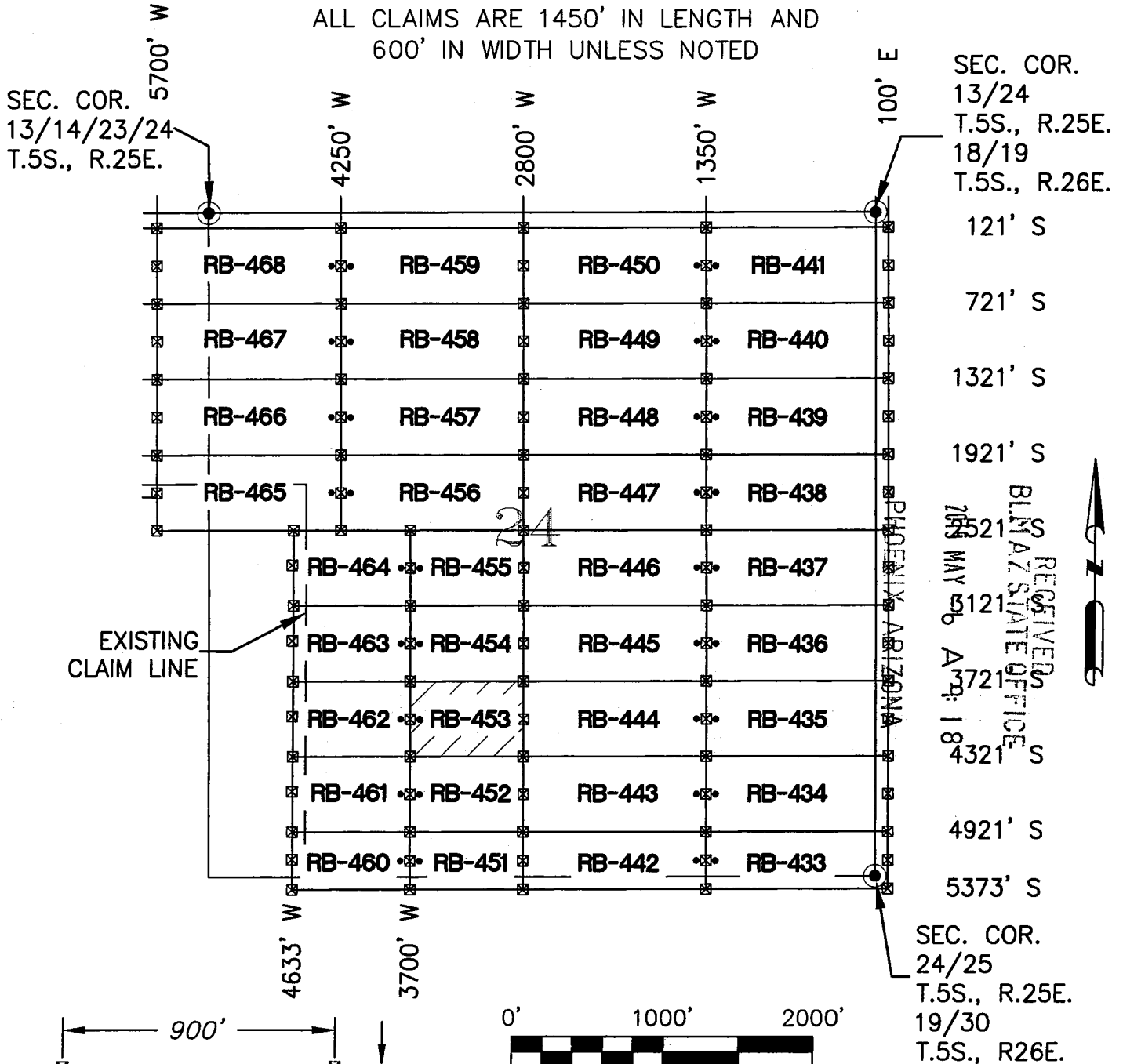

INDICATES CORNER OF LODE CLAIM.  
 SET 2"x2"x5' WOODEN POST (TYPICAL)

INDICATES LOCATION  
 MONUMENT. SET 2"x2"x5'  
 WOODEN POST WITH SIGN  
 (TYPICAL)

LOCATORS:  
 FREEPORT MINERALS CORP.  
 PO BOX 1019  
 SAFFORD AZ 85548

CLAIM ACREAGE = 12.4 AC  
 WC = WITNESS CORNER NORTH  
 OF SIDE LINE

**Entellus™**

2255 N. 44th Street Suite 125  
 Phoenix, AZ 85008.3279  
 Tel 602.244.2566  
 Fax 602.244.8947  
 Website: www.Entellus.com

LOCATION NOTICE FOR LODE MINING CLAIM

Amendment BLM Serial # \_\_\_\_\_

NOTICE IS HEREBY GIVEN that the Red Bull - 454

\_\_\_\_\_ lode mining claim has been located  
by Freeport Minerals Corporation whose current mailing  
address is P.O. Box 1019  
Safford, Arizona 85548

RECEIVED  
BLM AZ STATE OFFICE  
2015 MAY -6 A 9:18  
PHOENIX, ARIZONA  
BLM  
Date  
Stamp

The general course of this claim is East To West and it is situated in Graham  
County, Arizona. This claim is 900 feet in length and 600 feet in width.

12.4 Total Claim Acreage. This claim runs from the location monument on which this location notice  
is posted on the centerline of the claim approximately 10 feet in a Westerly direction to the West  
end line and 890 feet in a Easterly direction to the East end line. This claim is marked by six  
monuments, one at each corner and one at the center of each end line of the claim.

The location monument on which this notice is posted is situated within Section 24 Township 5  
S, Range 25 E, Gila Salt River Base and Meridian, Arizona and this claim encompasses portions  
of the following quarter section(s), section(s), Township(s) and Range(s) SW 1/4  
Section 24 Township 5S Range 25E

Gila Salt River Base and Meridian, Arizona.

The locality of this claim with reference to some natural object or permanent monument and additional information  
(if any) concerning its locality are as follows: The Northeast corner of the claim is 3121' South and 2800' West of the monument at the  
Northeast Corner of Section 24, Township 5S, Range 25E

The above information is shown on the attached map.

DATED AND POSTED on the ground this 8 day of April, 2015.

LOCATOR(s)  AGENT

Print Name(s) Entellus, Inc. - Daniel G. Francetic, RLS

Signature(s) *Daniel G. Francetic*

Form MCF100  
Revised July 2014

AM0432159

# RED BULL - 454 CLAIM

## LOCATION OF RED BULL-433 THROUGH RED BULL-468 LODE CLAIMS

LOCATED IN SECTIONS 23, 24, & 25 T.5S., R.25E., SECTIONS 19 & 30, T.5S., R.26E.  
GRAHAM COUNTY, ARIZONA

ALL CLAIMS ARE 1450' IN LENGTH AND  
600' IN WIDTH UNLESS NOTED

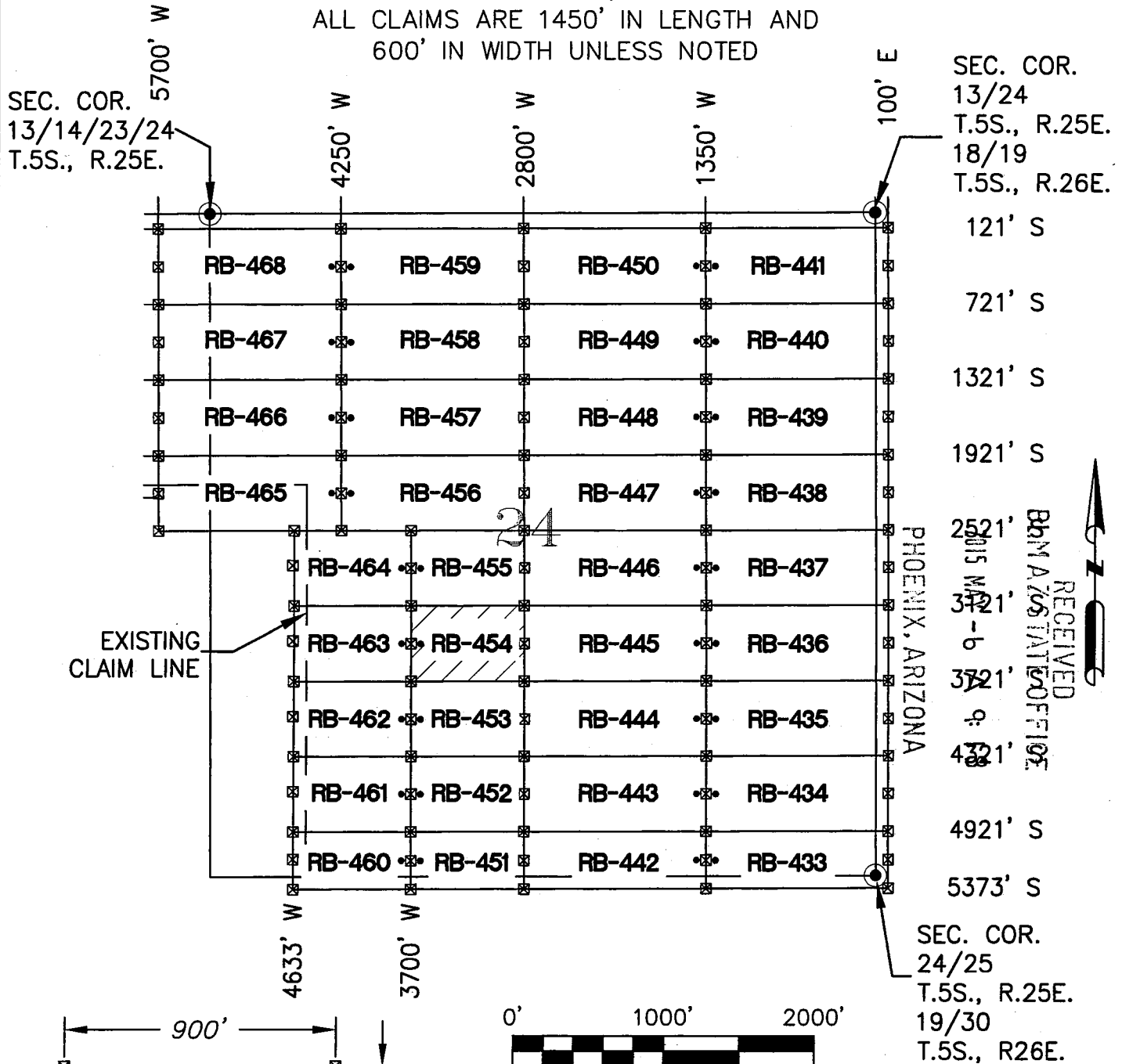

SEC. COR.  
13/24  
T.5S., R.25E.  
18/19  
T.5S., R.26E.

SEC. COR.  
13/14/23/24  
T.5S., R.25E.

PHOENIX, ARIZONA

RECEIVED  
BIRMINGHAM STATE OFFICE  
MAY 15 2015



SEC. COR.  
24/25  
T.5S., R.25E.  
19/30  
T.5S., R.26E.

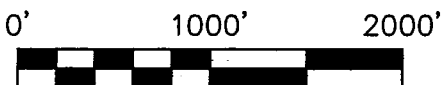
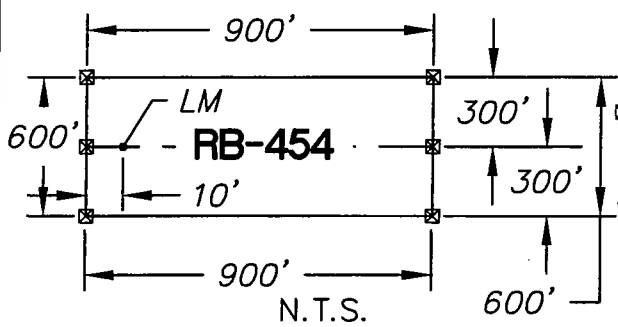

☒ INDICATES CORNER OF LODE CLAIM.  
SET 2"x2"x5' WOODEN POST (TYPICAL)

• INDICATES LOCATION  
MONUMENT. SET 2"x2"x5'  
WOODEN POST WITH SIGN  
(TYPICAL)

LOCATORS:  
FREEPORT MINERALS CORP.  
PO BOX 1019  
SAFFORD AZ 85548

CLAIM ACREAGE = 12.4 AC  
WC = WITNESS CORNER NORTH  
OF SIDE LINE

**Entellus™**  
2255 N. 44th Street Suite 125  
Phoenix, AZ 85008.3279  
Tel 602.244.2566  
Fax 602.244.8947  
Website: www.Entellus.com

LOCATION NOTICE FOR LODE MINING CLAIM

Amendment BLM Serial # \_\_\_\_\_

NOTICE IS HEREBY GIVEN that the Red Bull - 455

\_\_\_\_\_ lode mining claim has been located  
by Freeport Minerals Corporation whose current mailing  
address is P.O. Box 1019  
Safford, Arizona 85548

RECEIVED  
BLM AZ STATE OFFICE  
2015 MAY -6 A 9:18  
PHOENIX, ARIZONA  
BLM  
Date  
Stamp

The general course of this claim is East To West and it is situated in Graham  
County, Arizona. This claim is 900 feet in length and 600 feet in width.

12.4 Total Claim Acreage. This claim runs from the location monument on which this location notice  
is posted on the centerline of the claim approximately 10 feet in a Westerly direction to the West  
end line and 890 feet in a Easterly direction to the East end line. This claim is marked by six  
monuments, one at each corner and one at the center of each end line of the claim.

The location monument on which this notice is posted is situated within Section 24 Township 5  
S, Range 25 E, Gila Salt River Base and Meridian, Arizona and this claim encompasses portions  
of the following quarter section(s), section(s), Township(s) and Range(s) SW 1/4 and NW 1/4  
Section 24 Township 5S Range 25E

Gila Salt River Base and Meridian, Arizona.

The locality of this claim with reference to some natural object or permanent monument and additional information  
(if any) concerning its locality are as follows: The Northeast corner of the claim is 2521' South and 2800' West of the monument at the  
Northeast Corner of Section 24, Township 5S, Range 25E

The above information is shown on the attached map.

DATED AND POSTED on the ground this 8 day of April, 2015.

LOCATOR(s)  AGENT

Print Name(s) Entellus, Inc. - Daniel G. Francetic, RLS

Signature(s) *Daniel G. Francetic*

Form MCF100  
Revised July 2014

AMC 432160

# RED BULL - 455 CLAIM

## LOCATION OF RED BULL-433 THROUGH RED BULL-468 LODE CLAIMS

LOCATED IN SECTIONS 23, 24, & 25 T.5S., R.25E., SECTIONS 19 & 30, T.5S., R.26E.  
GRAHAM COUNTY, ARIZONA

ALL CLAIMS ARE 1450' IN LENGTH AND  
600' IN WIDTH UNLESS NOTED

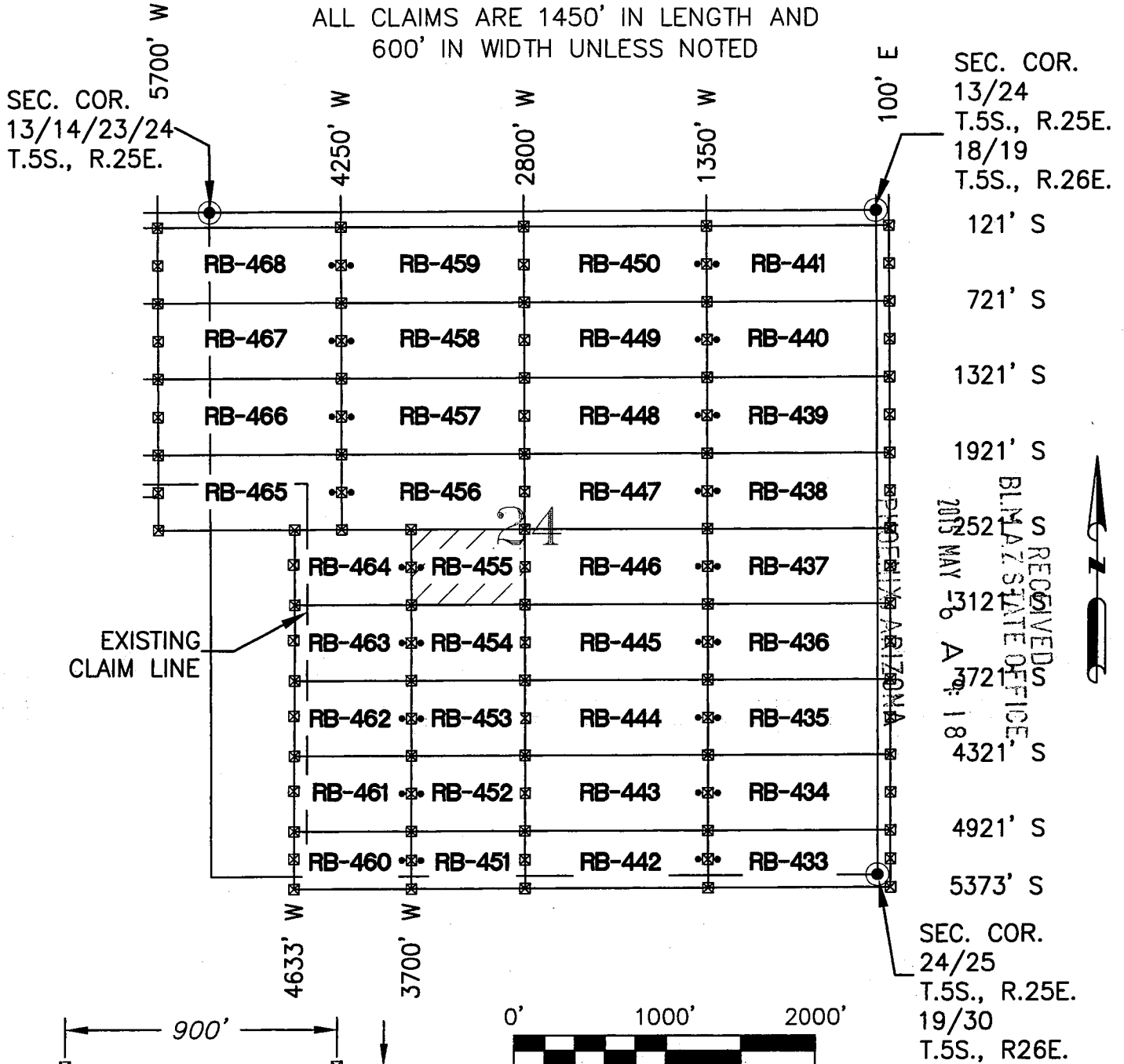

RECEIVED  
 BLM AZ STATE OFFICE  
 2015 MAY 26  
 3:12 PM  
 3721 S

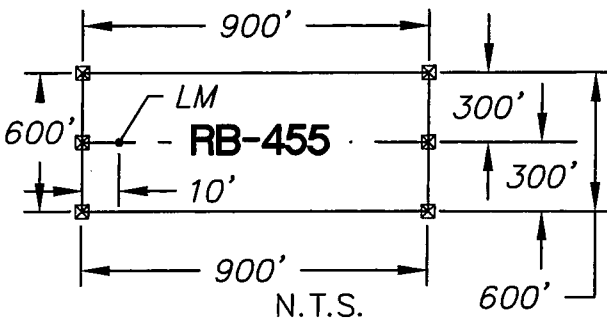

- ☒ INDICATES CORNER OF LODE CLAIM. SET 2"x2"x5' WOODEN POST (TYPICAL)
- INDICATES LOCATION MONUMENT. SET 2"x2"x5' WOODEN POST WITH SIGN (TYPICAL)

LOCATORS:  
 FREEPORT MINERALS CORP.  
 PO BOX 1019  
 SAFFORD AZ 85548

CLAIM ACREAGE = 12.4 AC  
 WC = WITNESS CORNER NORTH  
 OF SIDE LINE

**Entellus™**  
 2255 N. 44th Street Suite 125  
 Phoenix, AZ 85008.3279  
 Tel 602.244.2566  
 Fax 602.244.8947  
 Website: www.Entellus.com

LOCATION NOTICE FOR LODE MINING CLAIM

Amendment BLM Serial # \_\_\_\_\_

NOTICE IS HEREBY GIVEN that the Red Bull - 456

\_\_\_\_\_ lode mining claim has been located  
by Freeport Minerals Corporation whose current mailing  
address is P.O. Box 1019  
Safford, Arizona 85548

RECEIVED  
BLM AZ STATE OFFICE  
2015 MAY -6 A 9:18  
PHOENIX, ARIZONA  
BLM  
Date  
Stamp

The general course of this claim is East To West and it is situated in Graham  
County, Arizona. This claim is 1450 feet in length and 600 feet in width.

20.0 Total Claim Acreage. This claim runs from the location monument on which this location notice  
is posted on the centerline of the claim approximately 10 feet in a Westerly direction to the West  
end line and 1440 feet in a Easterly direction to the East end line. This claim is marked by six  
monuments, one at each corner and one at the center of each end line of the claim.

The location monument on which this notice is posted is situated within Section 24 Township 5  
S, Range 25 E, Gila Salt River Base and Meridian, Arizona and this claim encompasses portions  
of the following quarter section(s), section(s), Township(s) and Range(s) NW 1/4  
Section 24 Township 5S Range 25E

Gila Salt River Base and Meridian, Arizona.

The locality of this claim with reference to some natural object or permanent monument and additional information  
(if any) concerning its locality are as follows: The Northeast corner of the claim is 1921' South and 2800' West of the monument at the  
Northeast Corner of Section 24, Township 5S, Range 25E

The above information is shown on the attached map.

DATED AND POSTED on the ground this 8 day of April, 2015

LOCATOR(s)  AGENT

Print Name(s) Entellus, Inc. - Daniel G. Francetic, RLS

Signature(s) *Daniel G. Francetic*

Form MCF100  
Revised July 2014

AMC4321611

# RED BULL - 456 CLAIM

## LOCATION OF RED BULL-433 THROUGH RED BULL-468 LODE CLAIMS

LOCATED IN SECTIONS 23, 24, & 25 T.5S., R.25E., SECTIONS 19 & 30, T.5S., R.26E.  
GRAHAM COUNTY, ARIZONA

ALL CLAIMS ARE 1450' IN LENGTH AND  
600' IN WIDTH UNLESS NOTED

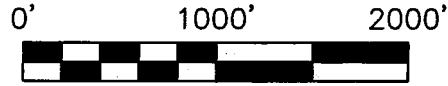
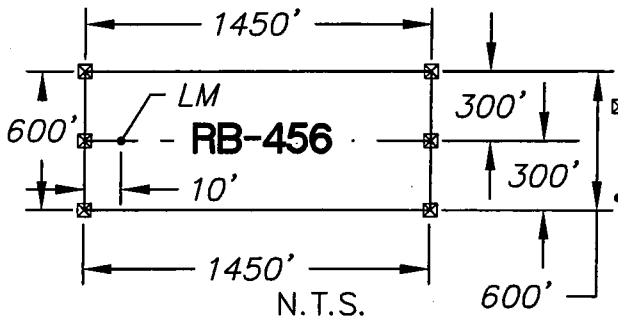
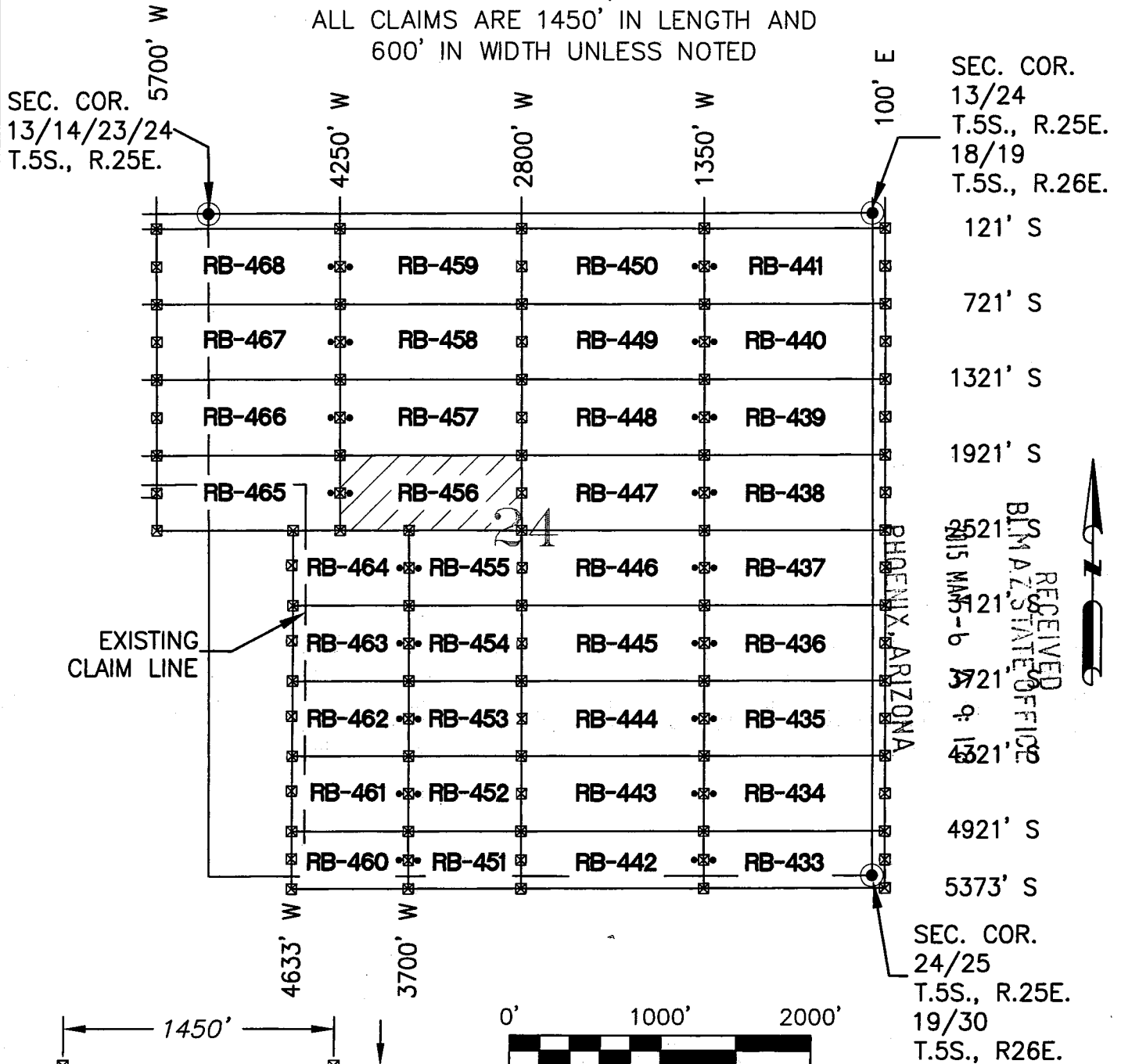

☒ INDICATES CORNER OF LODE CLAIM.  
SET 2"x2"x5' WOODEN POST (TYPICAL)

• INDICATES LOCATION  
MONUMENT. SET 2"x2"x5'  
WOODEN POST WITH SIGN  
(TYPICAL)

LOCATORS:  
FREEPORT MINERALS CORP.  
PO BOX 1019  
SAFFORD AZ 85548

CLAIM ACREAGE = 20.0 AC  
WC = WITNESS CORNER NORTH  
OF SIDE LINE

**Entellus™**  
2255 N. 44th Street Suite 125  
Phoenix, AZ 85008.3279  
Tel 602.244.2566  
Fax 602.244.8947  
Website: www.Entellus.com

LOCATION NOTICE FOR LODE MINING CLAIM

Amendment BLM Serial # \_\_\_\_\_

NOTICE IS HEREBY GIVEN that the Red Bull - 457

\_\_\_\_\_ lode mining claim has been located  
by Freeport Minerals Corporation whose current mailing  
address is P.O. Box 1019  
Safford, Arizona 85548

RECEIVED  
BLM AZ STATE OFFICE  
2015 MAY -6 A 9:18  
PHOENIX, ARIZONA  
BLM  
Date  
Stamp

The general course of this claim is East To West and it is situated in Graham  
County, Arizona. This claim is 1450 feet in length and 600 feet in width.

20.0 Total Claim Acreage. This claim runs from the location monument on which this location notice  
is posted on the centerline of the claim approximately 10 feet in a Westerly direction to the West  
end line and 1440 feet in a Easterly direction to the East end line. This claim is marked by six  
monuments, one at each corner and one at the center of each end line of the claim.

The location monument on which this notice is posted is situated within Section 24 Township 5  
S, Range 25 E, Gila Salt River Base and Meridian, Arizona and this claim encompasses portions  
of the following quarter section(s), section(s), Township(s) and Range(s) NW 1/4  
Section 24 Township 5S Range 25E

Gila Salt River Base and Meridian, Arizona.

The locality of this claim with reference to some natural object or permanent monument and additional information  
(if any) concerning its locality are as follows: The Northeast corner of the claim is 1321' South and 2800' West of the monument at the  
Northeast Corner of Section 24, Township 5S, Range 25E

The above information is shown on the attached map.

DATED AND POSTED on the ground this 8 day of April, 2015

LOCATOR(s)  AGENT

Print Name(s) Entellus, Inc. - Daniel G. Francetic, RLS

Signature(s) *Daniel G. Francetic*

Form MCF100  
Revised July 2014

AMC432162



# RED BULL - 457 CLAIM

## LOCATION OF RED BULL-433 THROUGH RED BULL-468 LODE CLAIMS

LOCATED IN SECTIONS 23, 24, & 25 T.5S., R.25E., SECTIONS 19 & 30, T.5S., R.26E.  
GRAHAM COUNTY, ARIZONA

ALL CLAIMS ARE 1450' IN LENGTH AND  
600' IN WIDTH UNLESS NOTED

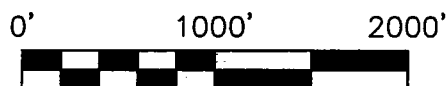
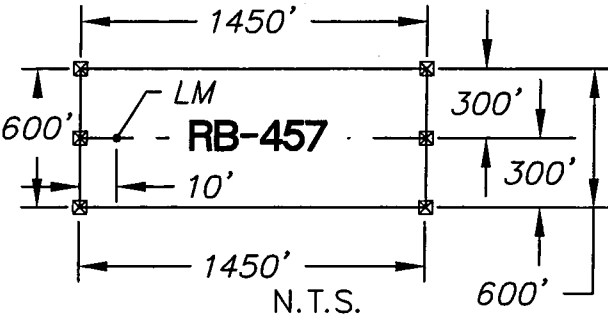
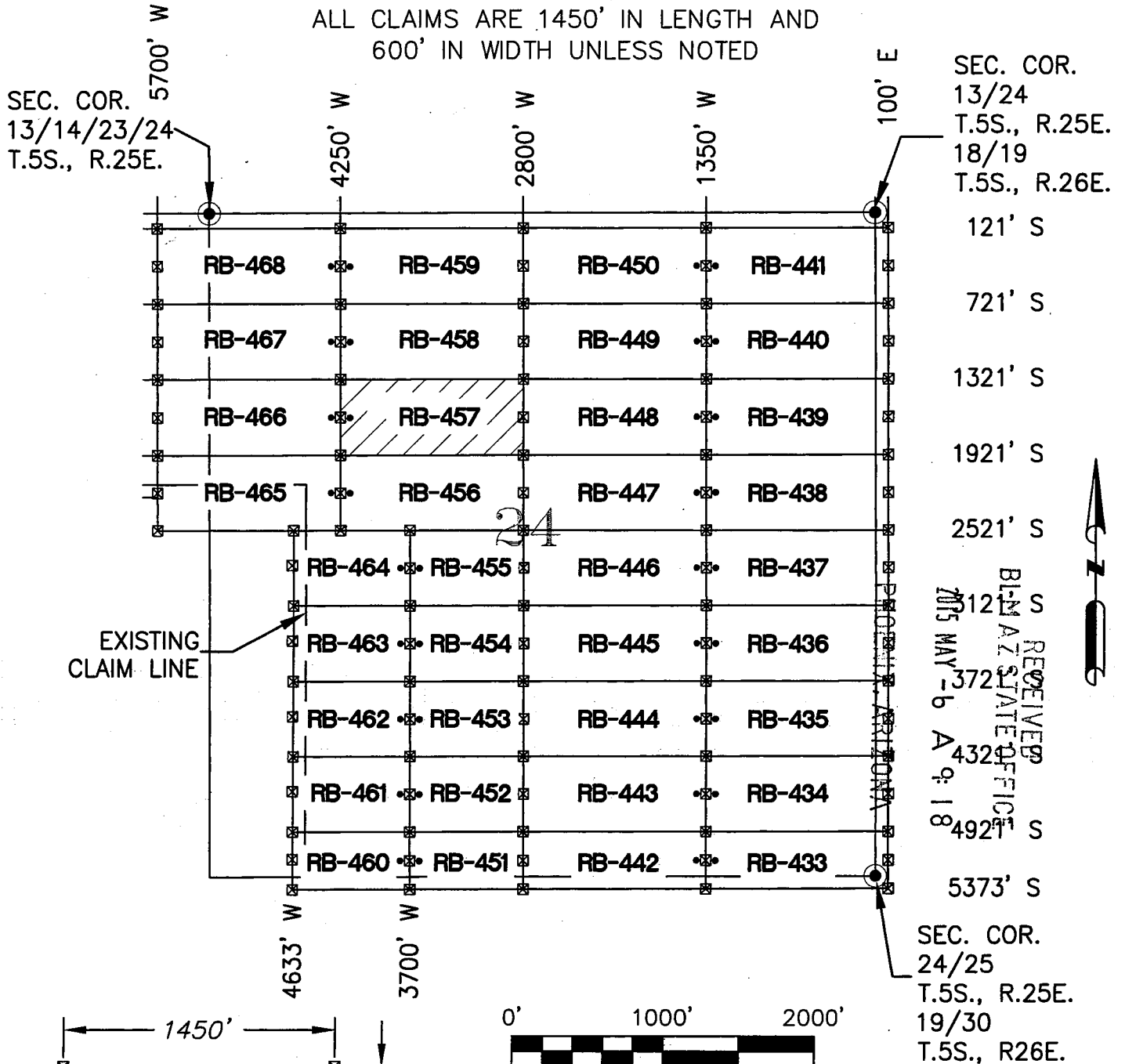

⊠ INDICATES CORNER OF LODE CLAIM.  
SET 2"x2"x5' WOODEN POST (TYPICAL)

• INDICATES LOCATION  
MONUMENT. SET 2"x2"x5'  
WOODEN POST WITH SIGN  
(TYPICAL)

CLAIM ACREAGE = 20.0 AC

WC = WITNESS CORNER NORTH  
OF SIDE LINE

**Entellus™**  
2255 N. 44th Street Suite 125  
Phoenix, AZ 85008.3279  
Tel 602.244.2566  
Fax 602.244.8947  
Website: www.Entellus.com

LOCATORS:  
FREEPORT MINERALS CORP.  
PO BOX 1019  
SAFFORD AZ 85548

RECEIVED  
B.L.M. AZ STATE OFFICE  
MAY 18 2005  
4320  
3721  
121

RECEIVED  
BLM AZ STATE OFFICE  
2015 MAY -6 A 9:18  
PHOENIX, ARIZONA

LOCATION NOTICE FOR LODE MINING CLAIM

Amendment BLM Serial # \_\_\_\_\_

NOTICE IS HEREBY GIVEN that the Red Bull - 458

\_\_\_\_\_ lode mining claim has been located  
by Freeport Minerals Corporation whose current mailing  
address is P.O. Box 1019  
Safford, Arizona 85548

BLM  
Date  
Stamp

The general course of this claim is East To West and it is situated in Graham  
County, Arizona. This claim is 1450 feet in length and 600 feet in width.

20.0 Total Claim Acreage. This claim runs from the location monument on which this location notice  
is posted on the centerline of the claim approximately 10 feet in a Westerly direction to the West  
end line and 1440 feet in a Easterly direction to the East end line. This claim is marked by six  
monuments, one at each corner and one at the center of each end line of the claim.

The location monument on which this notice is posted is situated within Section 24 Township 5  
S, Range 25 E, Gila Salt River Base and Meridian, Arizona and this claim encompasses portions  
of the following quarter section(s), section(s), Township(s) and Range(s) NW 1/4  
Section 24 Township 5S Range 25E

Gila Salt River Base and Meridian, Arizona.

The locality of this claim with reference to some natural object or permanent monument and additional information  
(if any) concerning its locality are as follows: The Northeast corner of the claim is 721' South and 2800' West of the monument at the  
Northeast Corner of Section 24, Township 5S, Range 25E

The above information is shown on the attached map.

DATED AND POSTED on the ground this 8 day of April, 2015

LOCATOR(s)  AGENT

Print Name(s) Entellus, Inc. - Daniel G. Francetic, RLS

Signature(s) *Daniel G. Francetic*

Form MCF100  
Revised July 2014

AMC432163

# RED BULL - 458 CLAIM

## LOCATION OF RED BULL-433 THROUGH RED BULL-468 LODE CLAIMS

LOCATED IN SECTIONS 23, 24, & 25 T.5S., R.25E., SECTIONS 19 & 30, T.5S., R.26E.  
GRAHAM COUNTY, ARIZONA

ALL CLAIMS ARE 1450' IN LENGTH AND 600' IN WIDTH UNLESS NOTED

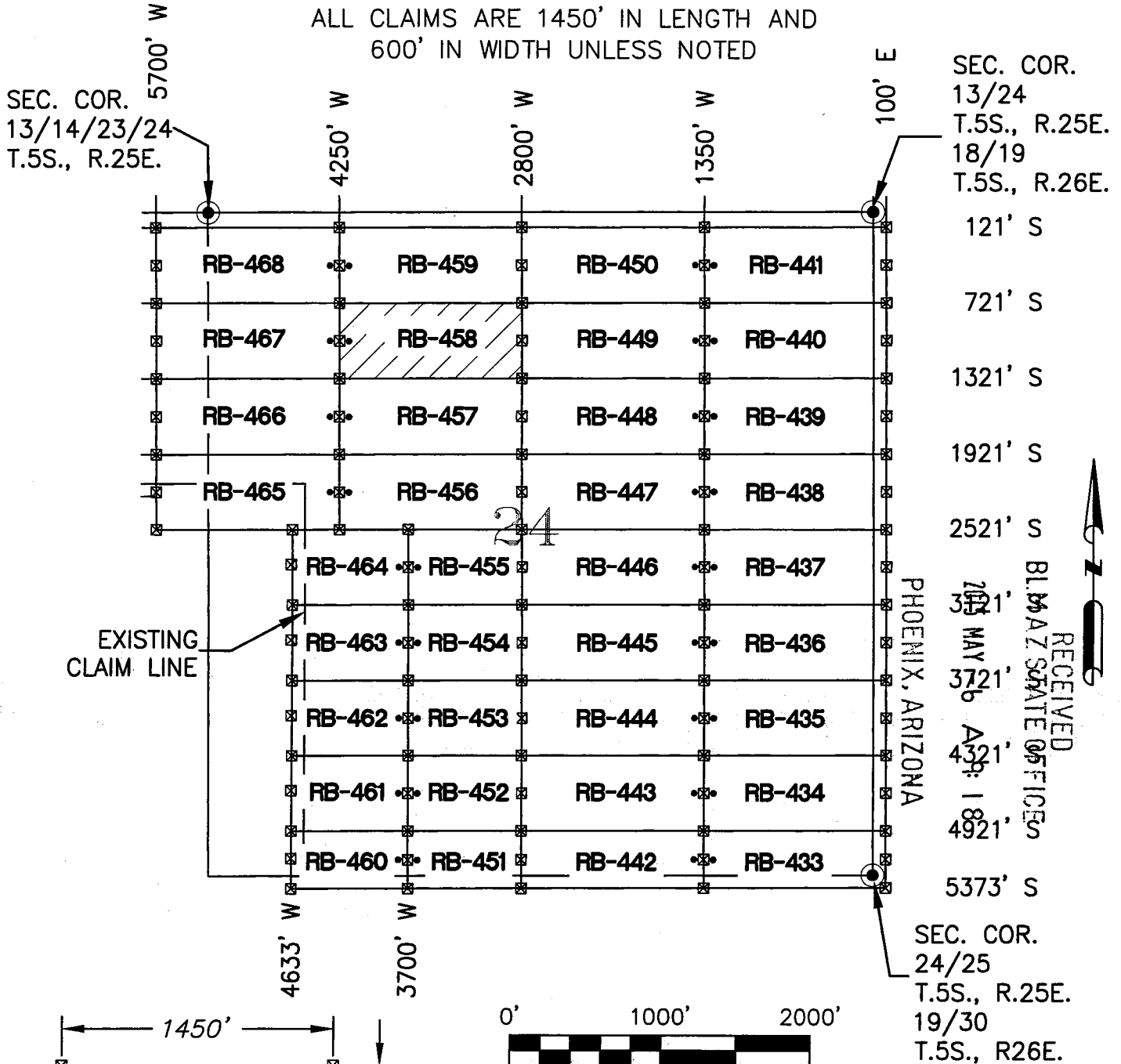

EXISTING CLAIM LINE

RECEIVED  
BLM AZ STATE OFFICES  
MAY 6 4 32 1  
APR 1 8 43 21  
4921'

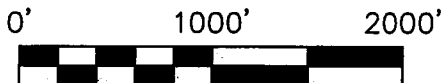
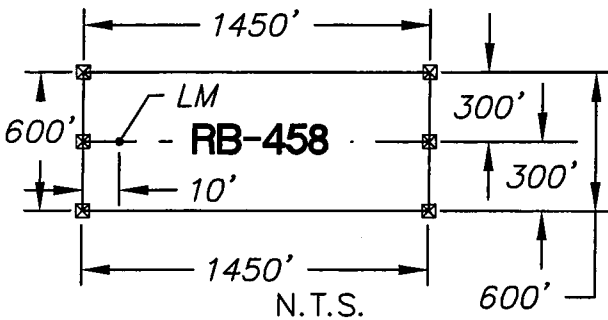

- ☒ INDICATES CORNER OF LODE CLAIM. SET 2"x2"x5' WOODEN POST (TYPICAL)
- INDICATES LOCATION MONUMENT. SET 2"x2"x5' WOODEN POST WITH SIGN (TYPICAL)

LOCATORS:  
FREEPORT MINERALS CORP.  
PO BOX 1019  
SAFFORD AZ 85548

CLAIM ACREAGE = 20.0 AC  
WC = WITNESS CORNER NORTH  
OF SIDE LINE

**Entellus™**  
2255 N. 44th Street Suite 125  
Phoenix, AZ 85008.3279  
Tel 602.244.2566  
Fax 602.244.8947  
Website: www.Entellus.com

LOCATION NOTICE FOR LODE MINING CLAIM

Amendment BLM Serial # \_\_\_\_\_

NOTICE IS HEREBY GIVEN that the Red Bull - 459

\_\_\_\_\_ lode mining claim has been located

by Freeport Minerals Corporation whose current mailing

address is P.O. Box 1019

Safford, Arizona 85548

BLM  
Date  
Stamp

RECEIVED  
BLM AZ STATE OFFICE  
2015 MAY -6 A 9:18  
PHOENIX, ARIZONA

The general course of this claim is East To West and it is situated in Graham

County, Arizona. This claim is 1450 feet in length and 600 feet in width.

20.0 Total Claim Acreage. This claim runs from the location monument on which this location notice

is posted on the centerline of the claim approximately 10 feet in a Westerly direction to the West

end line and 1440 feet in a Easterly direction to the East end line. This claim is marked by six

monuments, one at each corner and one at the center of each end line of the claim.

The location monument on which this notice is posted is situated within Section 24 Township 5

S, Range 25 E, Gila Salt River Base and Meridian, Arizona and this claim encompasses portions

of the following quarter section(s), section(s), Township(s) and Range(s) NW 1/4

Section 24 Township 5S Range 25E

Gila Salt River Base and Meridian, Arizona.

The locality of this claim with reference to some natural object or permanent monument and additional information

(if any) concerning its locality are as follows: The Northeast corner of the claim is 121' South and 2800' West of the monument at the

Northeast Corner of Section 24, Township 5S, Range 25E

The above information is shown on the attached map.

DATED AND POSTED on the ground this 8 day of April, 2015

LOCATOR(s)  AGENT

Print Name(s) Eptellus, Inc. - Daniel G. Francetic, RLS

Signature(s) *Daniel G. Francetic*

Form MCF100  
Revised July 2014

AMC432164

# RED BULL - 459 CLAIM

## LOCATION OF RED BULL-433 THROUGH RED BULL-468 LODE CLAIMS

LOCATED IN SECTIONS 23, 24, & 25 T.5S., R.25E., SECTIONS 19 & 30, T.5S., R.26E.  
GRAHAM COUNTY, ARIZONA

ALL CLAIMS ARE 1450' IN LENGTH AND  
600' IN WIDTH UNLESS NOTED

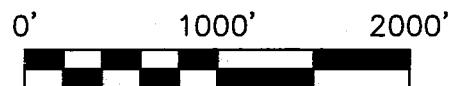
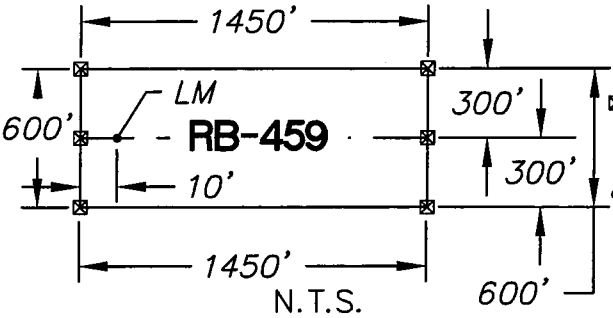
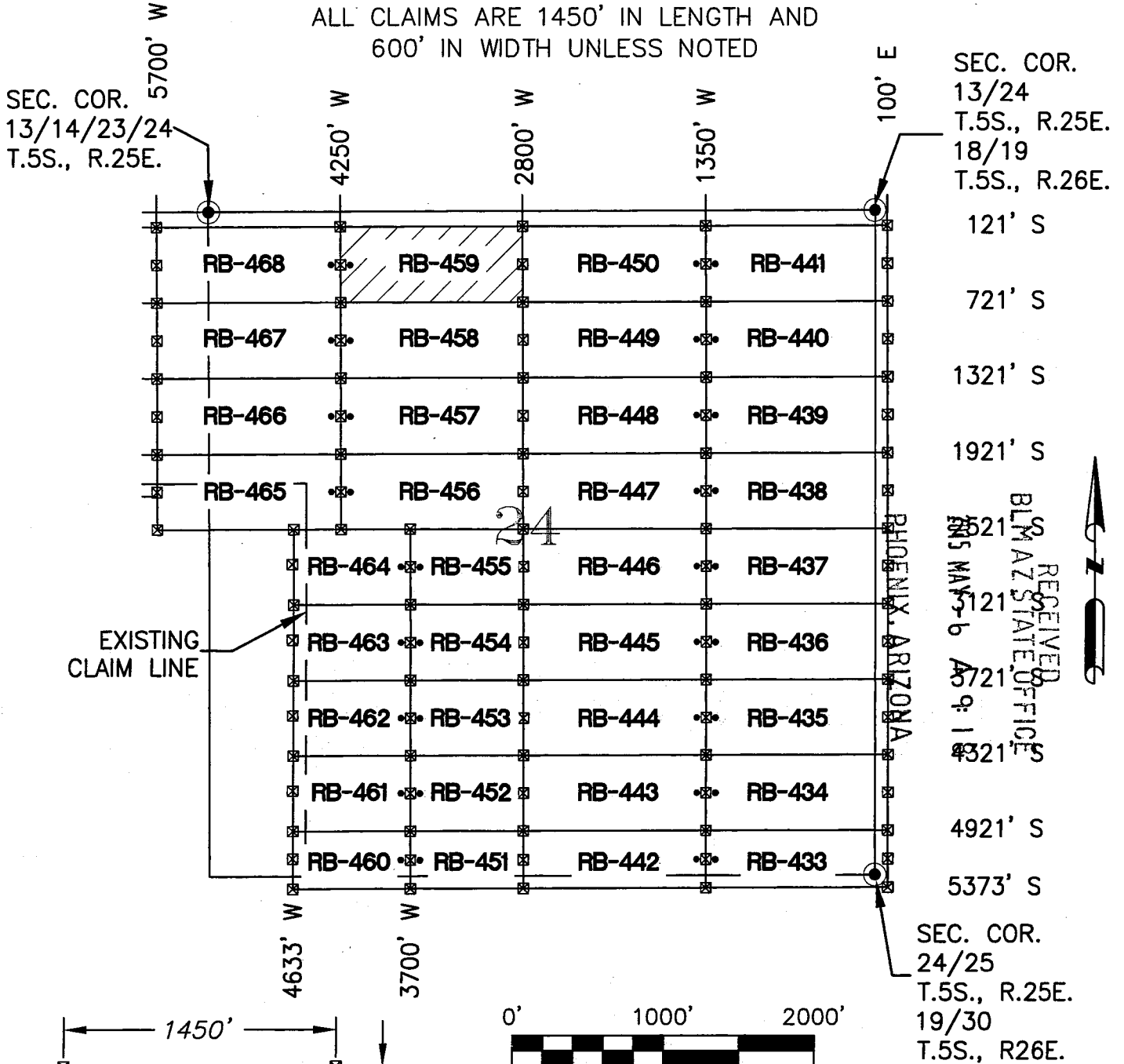

- ☒ INDICATES CORNER OF LODE CLAIM. SET 2"x2"x5' WOODEN POST (TYPICAL)
- INDICATES LOCATION MONUMENT. SET 2"x2"x5' WOODEN POST WITH SIGN (TYPICAL)

LOCATORS:  
FREEPORT MINERALS CORP.  
PO BOX 1019  
SAFFORD AZ 85548

CLAIM ACREAGE = 20.0 AC  
WC = WITNESS CORNER NORTH  
OF SIDE LINE

**Entellus™**  
2255 N. 44th Street Suite 125  
Phoenix, AZ 85008.3279  
Tel 602.244.2566  
Fax 602.244.8947  
Website: www.Entellus.com

LOCATION NOTICE FOR LODE MINING CLAIM

Amendment BLM Serial # \_\_\_\_\_

NOTICE IS HEREBY GIVEN that the Red Bull - 460

\_\_\_\_\_ lode mining claim has been located  
by Freeport Minerals Corporation whose current mailing  
address is P.O. Box 1019  
Safford, Arizona 85548

RECEIVED  
BLM AZ STATE OFFICE  
2015 MAY -6 A 9:18  
PHOENIX, ARIZONA  
BLM  
Date  
Stamp

The general course of this claim is East To West and it is situated in Graham  
County, Arizona. This claim is 933 feet in length and 457 feet in width.

9.8 Total Claim Acreage. This claim runs from the location monument on which this location notice  
is posted on the centerline of the claim approximately 10 feet in a Easterly direction to the East  
end line and 923 feet in a Westerly direction to the West end line. This claim is marked by six  
monuments, one at each corner and one at the center of each end line of the claim.

The location monument on which this notice is posted is situated within Section 24 Township 5  
S, Range 25 E, Gila Salt River Base and Meridian, Arizona and this claim encompasses portions  
of the following quarter section(s), section(s), Township(s) and Range(s) SW 1/4  
Section 24 Township 5S Range 25E and NW 1/4 Section 25 Township 5S Range 25E

Gila Salt River Base and Meridian, Arizona.

The locality of this claim with reference to some natural object or permanent monument and additional information  
(if any) concerning its locality are as follows: The Northeast corner of the claim is 4921' South and 3700' West of the monument at the  
Northeast Corner of Section 24, Township 5S, Range 25E

The above information is shown on the attached map.

DATED AND POSTED on the ground this 8 day of April, 2015

LOCATOR(s)  AGENT

Print Name(s) Entellus, Inc. - Daniel G. Francetic, RLS

Signature(s) *Daniel G. Francetic*

Form MCF100  
Revised July 2014

ANC 432165

# RED BULL - 460 CLAIM

## LOCATION OF RED BULL-433 THROUGH RED BULL-468 LODE CLAIMS

LOCATED IN SECTIONS 23, 24, & 25 T.5S., R.25E., SECTIONS 19 & 30, T.5S., R.26E.  
GRAHAM COUNTY, ARIZONA

ALL CLAIMS ARE 1450' IN LENGTH AND  
600' IN WIDTH UNLESS NOTED

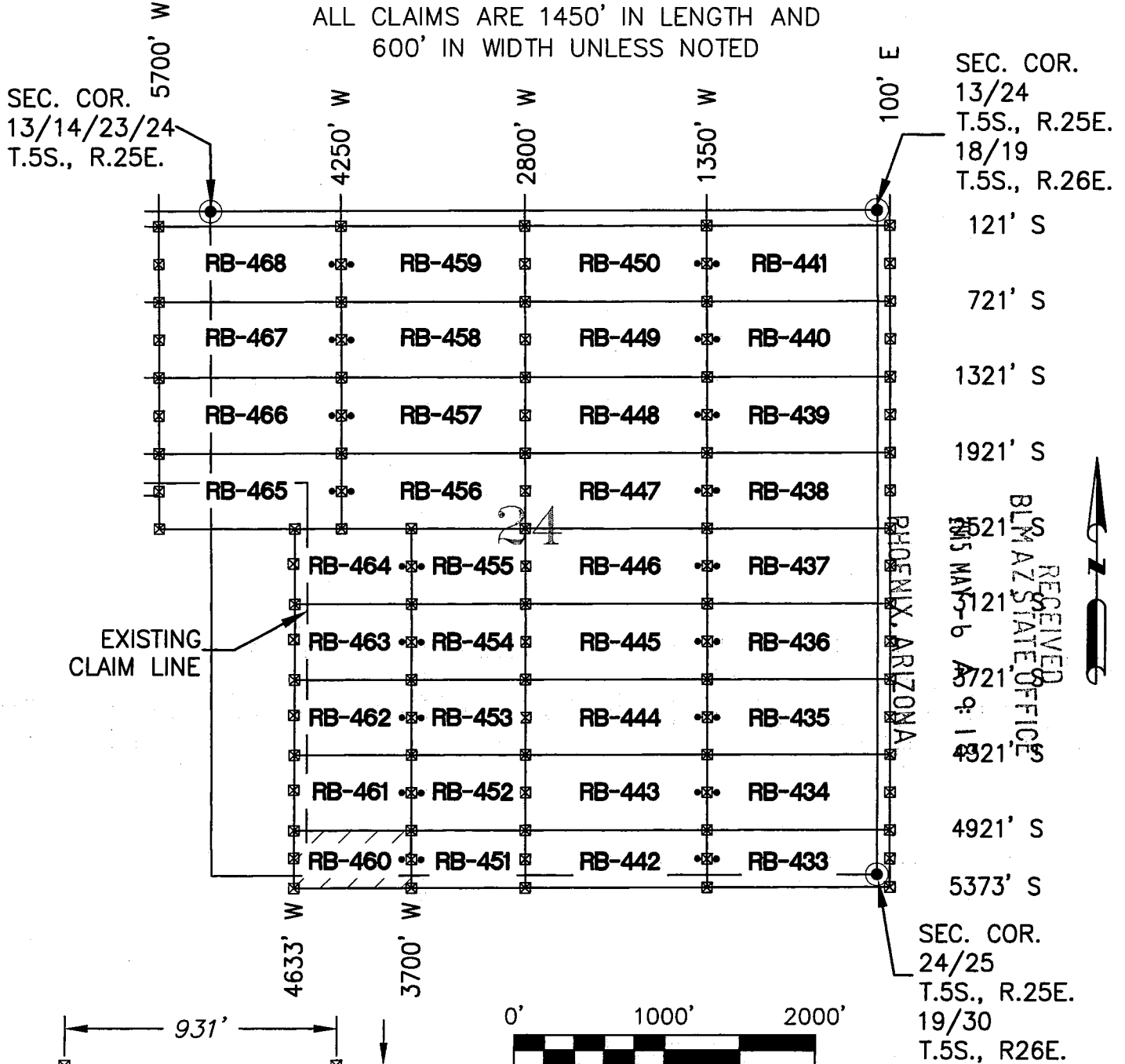

EXISTING CLAIM LINE

SEC. COR.  
13/24  
T.5S., R.25E.  
18/19  
T.5S., R.26E.

RECEIVED  
BLM AZ STATE OFFICE  
PHOENIX, ARIZONA  
MAY 6 2010

SEC. COR.  
24/25  
T.5S., R.25E.  
19/30  
T.5S., R.26E.

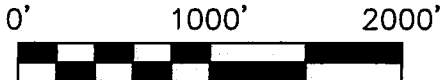
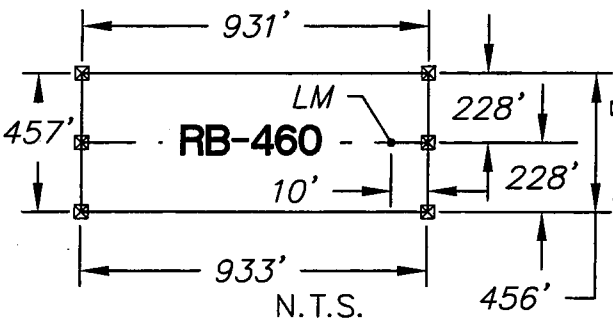

- ☒ INDICATES CORNER OF LODE CLAIM. SET 2"x2"x5' WOODEN POST (TYPICAL)
- INDICATES LOCATION MONUMENT. SET 2"x2"x5' WOODEN POST WITH SIGN (TYPICAL)

LOCATORS:  
FREEPORT MINERALS CORP.  
PO BOX 1019  
SAFFORD AZ 85548

CLAIM ACREAGE = 9.8 AC  
WC = WITNESS CORNER NORTH  
OF SIDE LINE

**Entellus™**  
2255 N. 44th Street Suite 125  
Phoenix, AZ 85008.3279  
Tel 602.244.2566  
Fax 602.244.8947  
Website: www.Entellus.com

LOCATION NOTICE FOR LODE MINING CLAIM

Amendment BLM Serial # \_\_\_\_\_

NOTICE IS HEREBY GIVEN that the Red Bull - 461

\_\_\_\_\_ lode mining claim has been located  
by Freeport Minerals Corporation whose current mailing  
address is P.O. Box 1019  
Safford, Arizona 85548

RECEIVED  
BLM AZ STATE OFFICE  
2015 MAY - 6 A 9: 18  
PHOENIX, ARIZONA  
BLM  
Date  
Stamp

The general course of this claim is East To West and it is situated in Graham

County, Arizona. This claim is 931 feet in length and 600 feet in width.

12.8 Total Claim Acreage. This claim runs from the location monument on which this location notice  
is posted on the centerline of the claim approximately 10 feet in a Easterly direction to the East  
end line and 921 feet in a Westerly direction to the West end line. This claim is marked by six  
monuments, one at each corner and one at the center of each end line of the claim.

The location monument on which this notice is posted is situated within Section 24 Township 5  
S, Range 25 E, Gila Salt River Base and Meridian, Arizona and this claim encompasses portions  
of the following quarter section(s), section(s), Township(s) and Range(s) SW 1/4

Section 24 Township 5S Range 25E

Gila Salt River Base and Meridian, Arizona.

The locality of this claim with reference to some natural object or permanent monument and additional information  
(if any) concerning its locality are as follows: The Northeast corner of the claim is 4321' South and 3700' West of the monument at the  
Northeast Corner of Section 24, Township 5S, Range 25E

The above information is shown on the attached map.

DATED AND POSTED on the ground this 8 day of April, 2015

LOCATOR(s)  AGENT

Print Name(s) Entellus, Inc. - Daniel G. Francetic, RLS

Signature(s) *Daniel G. Francetic*

Form MCF100  
Revised July 2014

AMC432166



# RED BULL - 461 CLAIM

## LOCATION OF RED BULL-433 THROUGH RED BULL-468 LODE CLAIMS

LOCATED IN SECTIONS 23, 24, & 25 T.5S., R.25E., SECTIONS 19 & 30, T.5S., R.26E.  
GRAHAM COUNTY, ARIZONA

ALL CLAIMS ARE 1450' IN LENGTH AND  
600' IN WIDTH UNLESS NOTED

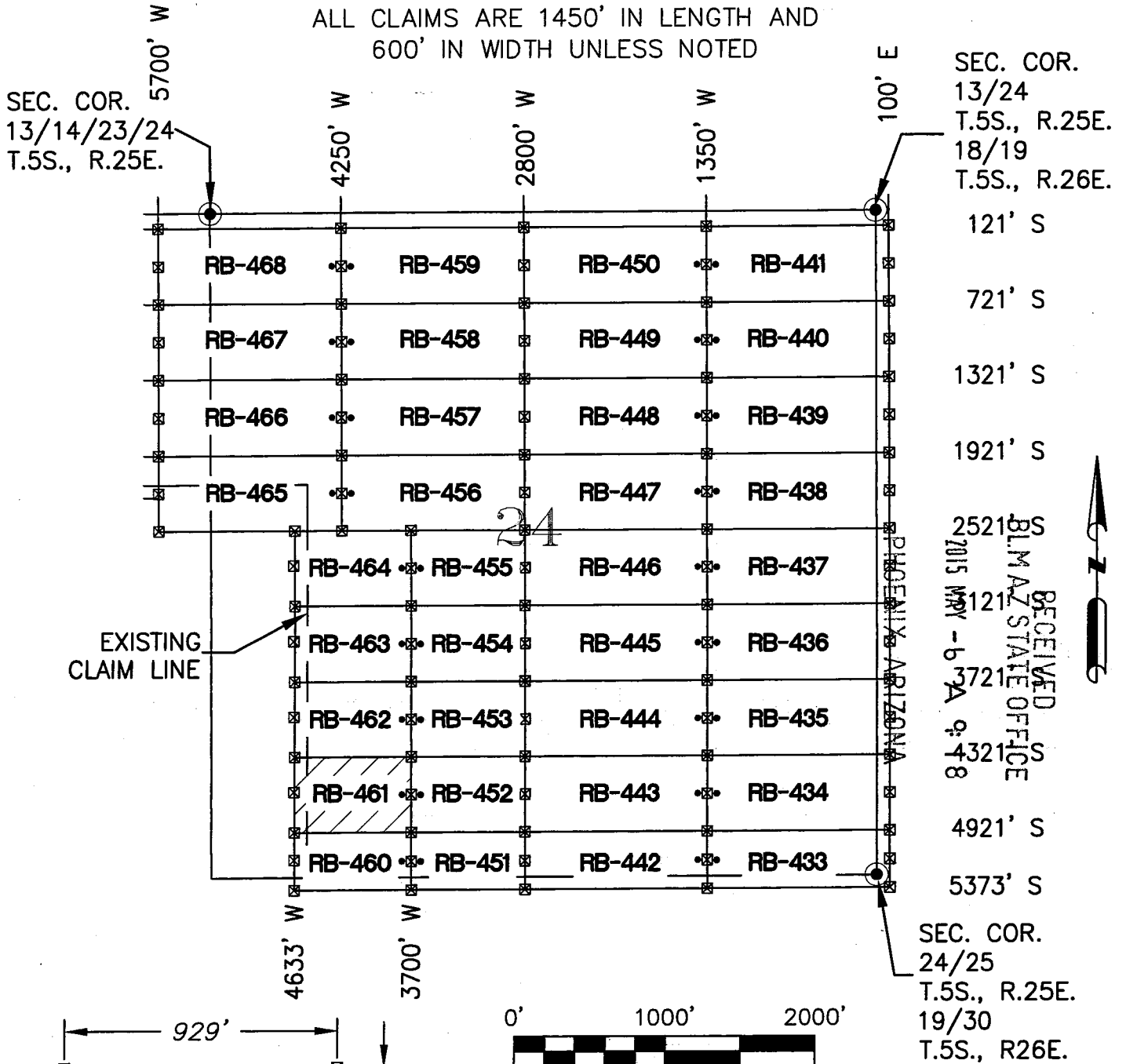

EXISTING CLAIM LINE

RECEIVED  
BLM AZ STATE OFFICE  
2015 MAY - 6 A  
3721  
4321  
8

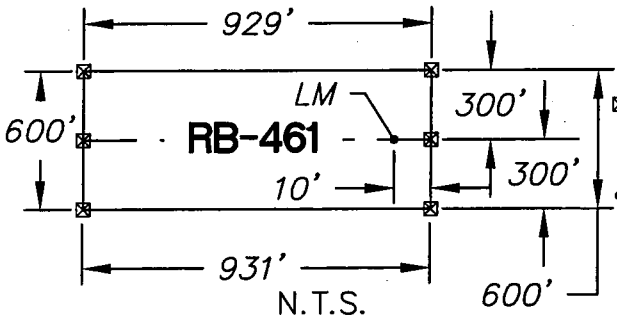

- ☒ INDICATES CORNER OF LODE CLAIM. SET 2"x2"x5' WOODEN POST (TYPICAL)
- INDICATES LOCATION MONUMENT. SET 2"x2"x5' WOODEN POST WITH SIGN (TYPICAL)

LOCATORS:  
FREEPORT MINERALS CORP.  
PO BOX 1019  
SAFFORD AZ 85548

CLAIM ACREAGE = 12.8 AC  
WC = WITNESS CORNER NORTH  
OF SIDE LINE

**Entellus™**  
2255 N. 44th Street Suite 125  
Phoenix, AZ 85008.3279  
Tel 602.244.2566  
Fax 602.244.8947  
Website: www.Entellus.com

LOCATION NOTICE FOR LODE MINING CLAIM

Amendment BLM Serial # \_\_\_\_\_

NOTICE IS HEREBY GIVEN that the Red Bull - 462

\_\_\_\_\_ lode mining claim has been located

by Freeport Minerals Corporation whose current mailing

address is P.O. Box 1019

Safford, Arizona 85548

The general course of this claim is East To West and it is situated in

County, Arizona. This claim is 929 feet in length and 600 feet in width.

12.8 Total Claim Acreage. This claim runs from the location monument on which this location notice

is posted on the centerline of the claim approximately 10 feet in a Easterly direction to the East

end line and 919 feet in a Westerly direction to the West end line. This claim is marked by six

monuments, one at each corner and one at the center of each end line of the claim.

The location monument on which this notice is posted is situated within Section 24 Township 5

S, Range 25 E, Gila Salt River Base and Meridian, Arizona and this claim encompasses portions

of the following quarter section(s), section(s), Township(s) and Range(s) SW 1/4

Section 24 Township 5S Range 25E

Gila Salt River Base and Meridian, Arizona.

The locality of this claim with reference to some natural object or permanent monument and additional information

(if any) concerning its locality are as follows: The Northeast corner of the claim is 3721' South and 3700' West of the monument at the

Northeast Corner of Section 24, Township 5S, Range 25E

The above information is shown on the attached map.

DATED AND POSTED on the ground this 8 day of April, 2015.

LOCATOR(s)  AGENT

Print Name(s) Entellus, Inc. - Daniel G. Francetic, RLS

Signature(s) *Daniel G. Francetic*

RECEIVED  
BLM AZ STATE OFFICE  
2015 MAY -6 A 9:17  
PHOENIX, ARIZONA  
Graham  
BLM  
Date  
Stamp

AN04321671

Form MCF100  
Revised July 2014

# RED BULL - 462 CLAIM

## LOCATION OF RED BULL-433 THROUGH RED BULL-468 LODE CLAIMS

LOCATED IN SECTIONS 23, 24, & 25 T.5S., R.25E., SECTIONS 19 & 30, T.5S., R.26E.  
GRAHAM COUNTY, ARIZONA

ALL CLAIMS ARE 1450' IN LENGTH AND  
600' IN WIDTH UNLESS NOTED

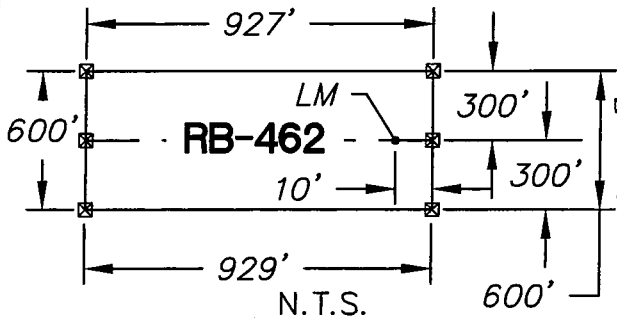
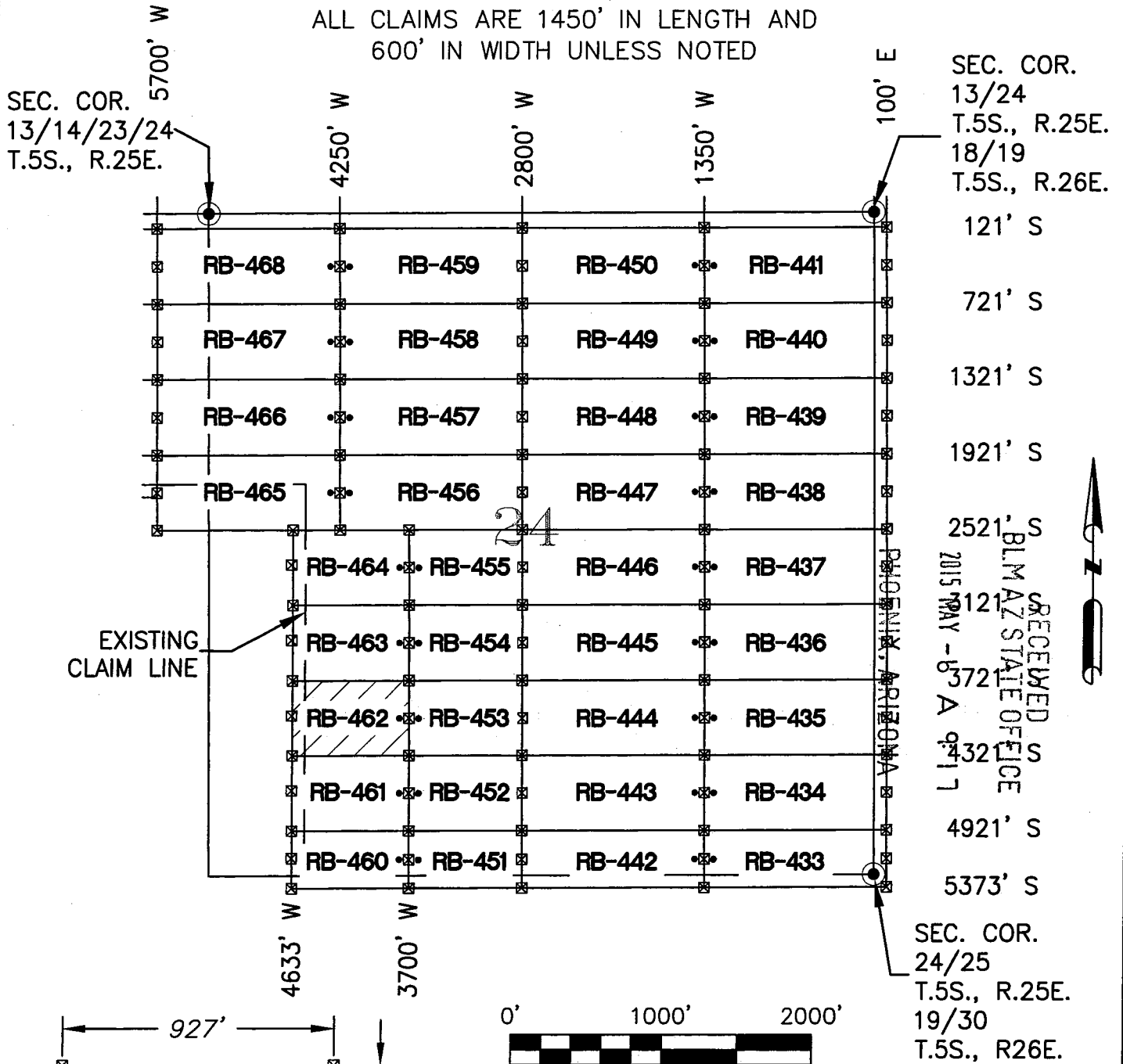

LOCATORS:  
FREEPORT MINERALS CORP.  
PO BOX 1019  
SAFFORD AZ 85548

0' 1000' 2000'

INDICATES CORNER OF LODE CLAIM.  
SET 2"x2"x5' WOODEN POST (TYPICAL)

INDICATES LOCATION  
MONUMENT. SET 2"x2"x5'  
WOODEN POST WITH SIGN  
(TYPICAL)

CLAIM ACREAGE = 12.8 AC

WC = WITNESS CORNER NORTH  
OF SIDE LINE

**Entellus™**

2255 N. 44th Street Suite 125  
Phoenix, AZ 85008.3279  
Tel 602.244.2566  
Fax 602.244.8947  
Website: www.Entellus.com

RECEIVED  
BLM AZ STATE OFFICE  
2015 MAY - 16 A 9:17

LOCATION NOTICE FOR LODE MINING CLAIM

Amendment BLM Serial # \_\_\_\_\_

NOTICE IS HEREBY GIVEN that the Red Bull - 463

\_\_\_\_\_ lode mining claim has been located

by Freeport Minerals Corporation whose current mailing

address is P.O. Box 1019

Safford, Arizona 85548

RECEIVED  
BLM AZ STATE OFFICE  
2015 MAY -6 A 9:17  
PHOENIX, ARIZONA  
BLM  
Date  
Stamp

The general course of this claim is East To West and it is situated in Graham

County, Arizona. This claim is 927 feet in length and 600 feet in width.

12.8 Total Claim Acreage. This claim runs from the location monument on which this location notice

is posted on the centerline of the claim approximately 10 feet in a Easterly direction to the East

end line and 917 feet in a Westerly direction to the West end line. This claim is marked by six

monuments, one at each corner and one at the center of each end line of the claim.

The location monument on which this notice is posted is situated within Section 24 Township 5

S, Range 25 E, Gila Salt River Base and Meridian, Arizona and this claim encompasses portions

of the following quarter section(s), section(s), Township(s) and Range(s) SW 1/4

Section 24 Township 5S Range 25E

Gila Salt River Base and Meridian, Arizona.

The locality of this claim with reference to some natural object or permanent monument and additional information

(if any) concerning its locality are as follows: The Northeast corner of the claim is 3121' South and 3700' West of the monument at the

Northeast Corner of Section 24, Township 5S, Range 25E

The above information is shown on the attached map.

DATED AND POSTED on the ground this 8 day of April, 2015.

LOCATOR(s)  AGENT

Print Name(s) Entellus, Inc. - Daniel G. Francetic, RLS

Signature(s) *Daniel G. Francetic*

Form MCF100  
Revised July 2014

AMC432168

# RED BULL - 463 CLAIM

## LOCATION OF RED BULL-433 THROUGH RED BULL-468 LODE CLAIMS

LOCATED IN SECTIONS 23, 24, & 25 T.5S., R.25E., SECTIONS 19 & 30, T.5S., R.26E.  
GRAHAM COUNTY, ARIZONA

ALL CLAIMS ARE 1450' IN LENGTH AND  
600' IN WIDTH UNLESS NOTED

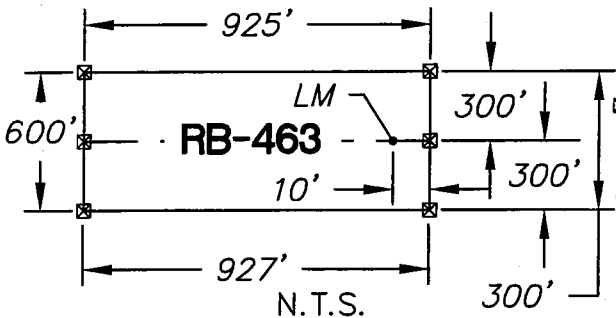
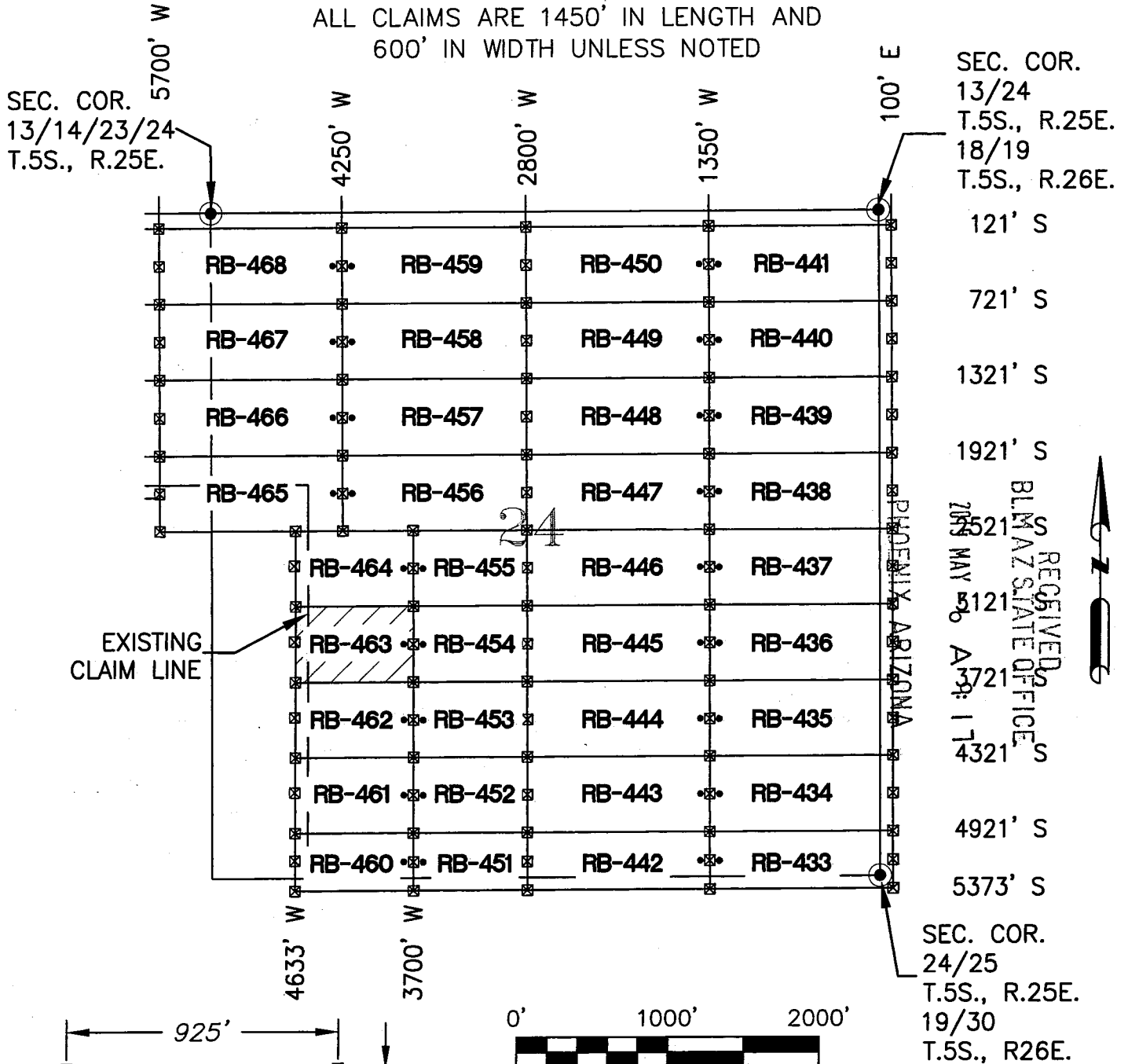

LOCATORS:  
FREEPORT MINERALS CORP.  
PO BOX 1019  
SAFFORD AZ 85548

CLAIM ACREAGE = 12.8 AC  
WC = WITNESS CORNER NORTH  
OF SIDE LINE

**Entellus™**  
2255 N. 44th Street Suite 125  
Phoenix, AZ 85008.3279  
Tel 602.244.2566  
Fax 602.244.8947  
Website: www.Entellus.com

RECEIVED  
BLM AZ STATE OFFICE  
MAY 9 2009  
APR 17 4321 S

LOCATION NOTICE FOR LODE MINING CLAIM

Amendment BLM Serial # \_\_\_\_\_

NOTICE IS HEREBY GIVEN that the Red Bull - 464

\_\_\_\_\_ lode mining claim has been located

by Freeport Minerals Corporation whose current mailing

address is P.O. Box 1019

Safford, Arizona 85548

RECEIVED  
BLM AZ STATE OFFICE  
2015 MAY -6 A 9:17  
PHOENIX, ARIZONA  
BLM  
Date  
Stamp

The general course of this claim is East To West and it is situated in Graham

County, Arizona. This claim is 925 feet in length and 600 feet in width.

12.7 Total Claim Acreage. This claim runs from the location monument on which this location notice

is posted on the centerline of the claim approximately 10 feet in a Easterly direction to the East

end line and 915 feet in a Westerly direction to the West end line. This claim is marked by six

monuments, one at each corner and one at the center of each end line of the claim.

The location monument on which this notice is posted is situated within Section 24 Township 5

S, Range 25 E, Gila Salt River Base and Meridian, Arizona and this claim encompasses portions

of the following quarter section(s), section(s), Township(s) and Range(s) NW 1/4 and SW 1/4

Section 24 Township 5S Range 25E

Gila Salt River Base and Meridian, Arizona.

The locality of this claim with reference to some natural object or permanent monument and additional information

(if any) concerning its locality are as follows: The Northeast corner of the claim is 2521' South and 3700' West of the monument at the

Northeast Corner of Section 24, Township 5S, Range 25E

The above information is shown on the attached map.

DATED AND POSTED on the ground this 8 day of April, 2015

LOCATOR(s)  AGENT

Print Name(s) Entellus, Inc. - Daniel G. Francetic, RLS

Signature(s) *Daniel G. Francetic*

Form MCF100  
Revised July 2014

AMC432169

# RED BULL - 464 CLAIM

## LOCATION OF RED BULL-433 THROUGH RED BULL-468 LODE CLAIMS

LOCATED IN SECTIONS 23, 24, & 25 T.5S., R.25E., SECTIONS 19 & 30, T.5S., R.26E.  
GRAHAM COUNTY, ARIZONA

ALL CLAIMS ARE 1450' IN LENGTH AND  
600' IN WIDTH UNLESS NOTED

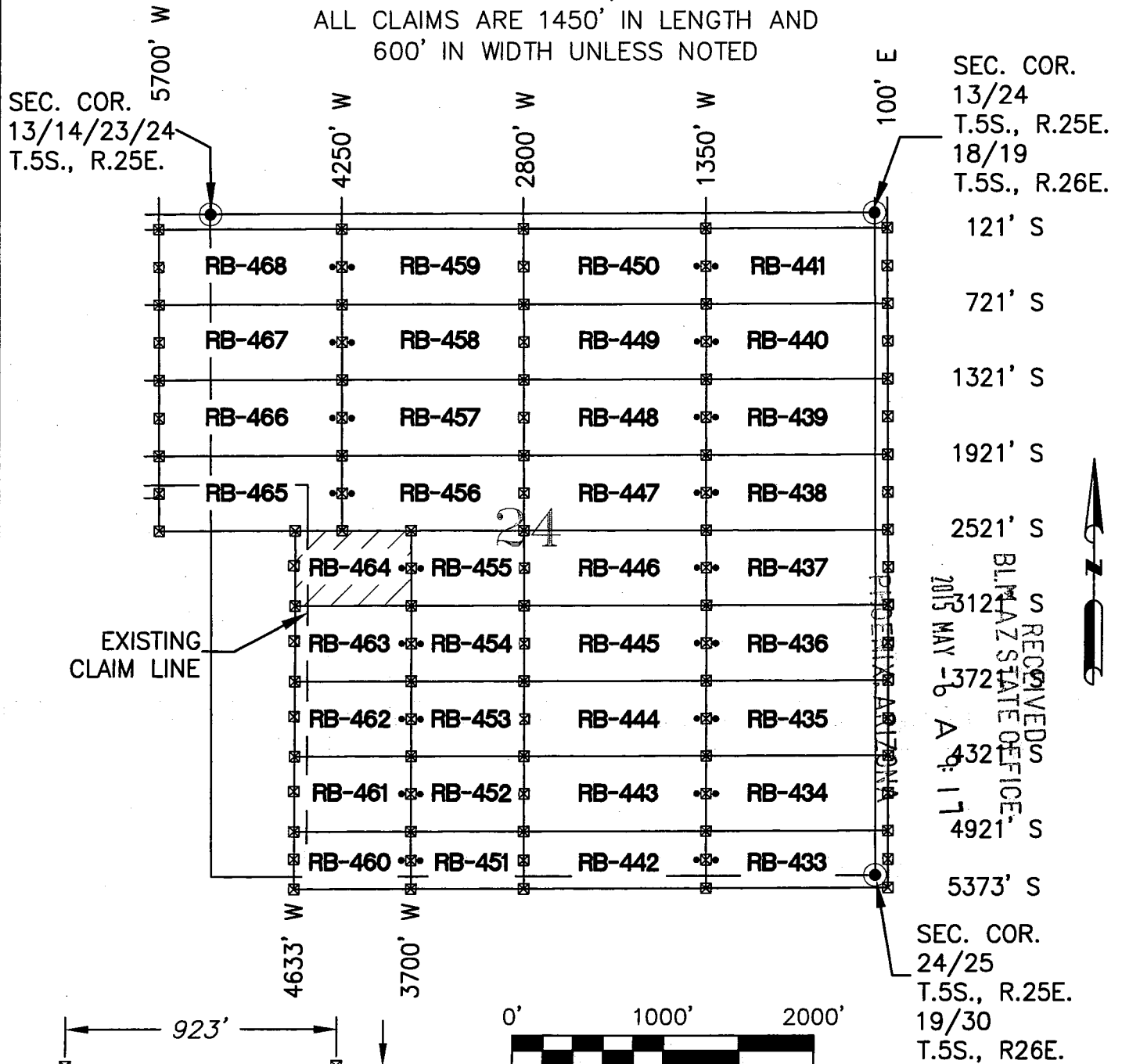

EXISTING CLAIM LINE

RECEIVED  
BLM AZ STATE OFFICE  
2015 MAY 19  
372 A  
432

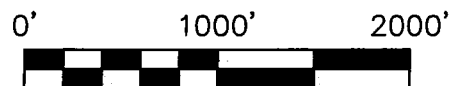
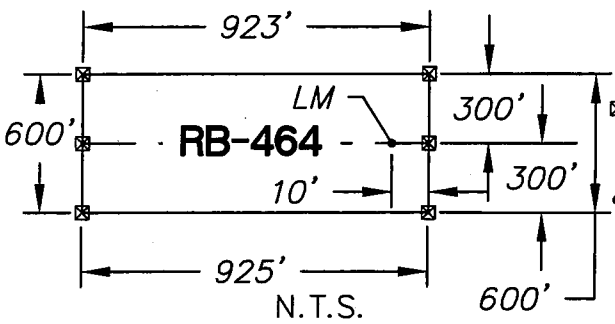

- ☒ INDICATES CORNER OF LODE CLAIM. SET 2"x2"x5' WOODEN POST (TYPICAL)
- INDICATES LOCATION MONUMENT. SET 2"x2"x5' WOODEN POST WITH SIGN (TYPICAL)

LOCATORS:  
FREEPORT MINERALS CORP.  
PO BOX 1019  
SAFFORD AZ 85548

CLAIM ACREAGE = 12.7 AC  
WC = WITNESS CORNER NORTH  
OF SIDE LINE

**Entellus™**  
2255 N. 44th Street Suite 125  
Phoenix, AZ 85008.3279  
Tel 602.244.2566  
Fax 602.244.8947  
Website: www.Entellus.com

RECEIVED  
BLM AZ STATE OFFICE  
2015 MAY -6 A 9:17  
PHOENIX, ARIZONA

**LOCATION NOTICE FOR LODE MINING CLAIM**

Amendment BLM Serial # \_\_\_\_\_

NOTICE IS HEREBY GIVEN that the Red Bull - 465

\_\_\_\_\_ lode mining claim has been located  
by Freeport Minerals Corporation whose current mailing  
address is P.O. Box 1019  
Safford, Arizona 85548

BLM  
Date  
Stamp

The general course of this claim is East To West and it is situated in Graham  
County, Arizona. This claim is 1450 feet in length and 600 feet in width.

20.0 Total Claim Acreage. This claim runs from the location monument on which this location notice  
is posted on the centerline of the claim approximately 10 feet in a Easterly direction to the East  
end line and 1440 feet in a Westerly direction to the West end line. This claim is marked by six  
monuments, one at each corner and one at the center of each end line of the claim.

The location monument on which this notice is posted is situated within Section 24 Township 5  
S, Range 25 E, Gila Salt River Base and Meridian, Arizona and this claim encompasses portions  
of the following quarter section(s), section(s), Township(s) and Range(s) NW 1/4

Section 24 Township 5S Range 25E and NE 1/4 Section 23 Township 5S Range 25E  
Gila Salt River Base and Meridian, Arizona.

The locality of this claim with reference to some natural object or permanent monument and additional information  
(if any) concerning its locality are as follows: The Northeast corner of the claim is 1921' South and 4250' West of the monument at the  
Northeast Corner of Section 24, Township 5S, Range 25E

The above information is shown on the attached map.

DATED AND POSTED on the ground this 8 day of April, 2015.

LOCATOR(s)  AGENT

Print Name(s) Entellus, Inc. - Daniel G. Francetic, RLS

Signature(s) *Daniel G. Francetic*

Form MCF100  
Revised July 2014

AMC432170



# RED BULL - 465 CLAIM

## LOCATION OF RED BULL-433 THROUGH RED BULL-468 LODE CLAIMS

LOCATED IN SECTIONS 23, 24, & 25 T.5S., R.25E., SECTIONS 19 & 30, T.5S., R.26E.  
GRAHAM COUNTY, ARIZONA

ALL CLAIMS ARE 1450' IN LENGTH AND  
600' IN WIDTH UNLESS NOTED

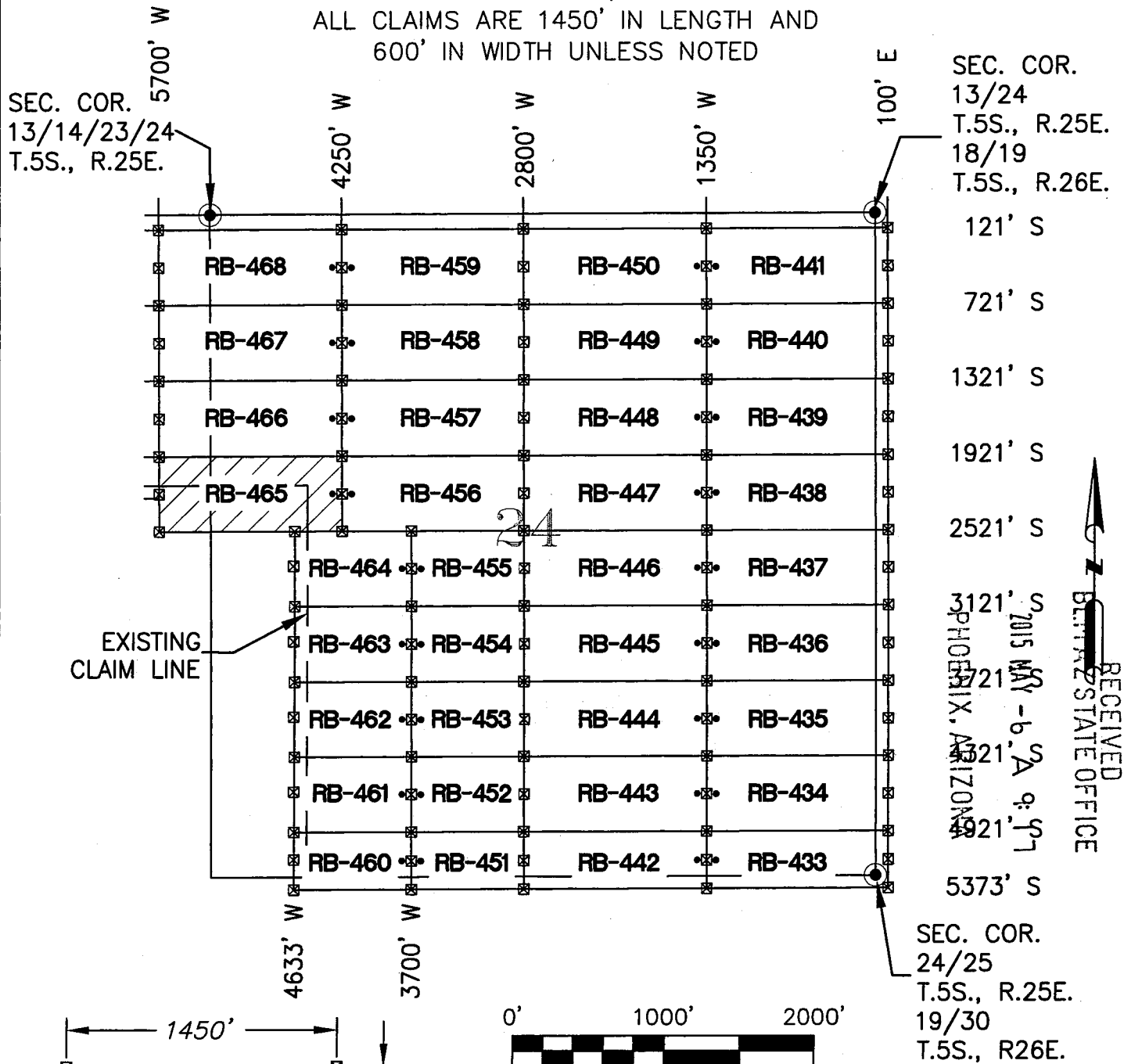

RECEIVED  
STATE OFFICE  
PHOENIX, ARIZONA  
2015 MAY -6- 9:07

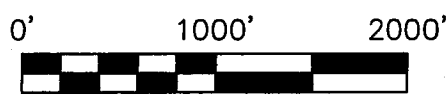
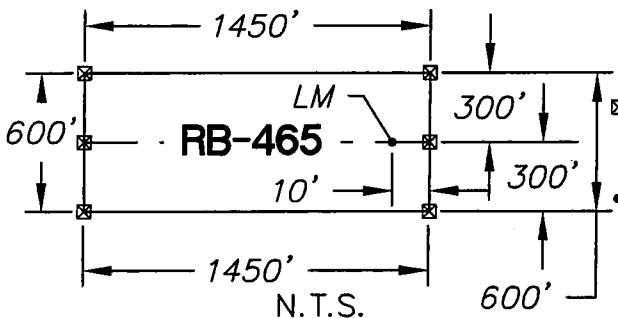

- ☒ INDICATES CORNER OF LODE CLAIM. SET 2"x2"x5' WOODEN POST (TYPICAL)
- INDICATES LOCATION MONUMENT. SET 2"x2"x5' WOODEN POST WITH SIGN (TYPICAL)

LOCATORS:  
FREEPORT MINERALS CORP.  
PO BOX 1019  
SAFFORD AZ 85548

CLAIM ACREAGE = 20.0 AC  
WC = WITNESS CORNER NORTH  
OF SIDE LINE

**Entellus™**  
2255 N. 44th Street Suite 125  
Phoenix, AZ 85008.3279  
Tel 602.244.2566  
Fax 602.244.8947  
Website: www.Entellus.com

RECEIVED  
BLM AZ STATE OFFICE  
2015 MAY -6 A 9:17  
PHOENIX, ARIZONA

**LOCATION NOTICE FOR LODE MINING CLAIM**

Amendment      BLM Serial # \_\_\_\_\_

NOTICE IS HEREBY GIVEN that the Red Bull - 466

\_\_\_\_\_ lode mining claim has been located

by Freeport Minerals Corporation whose current mailing

address is P.O. Box 1019

Safford, Arizona 85548

BLM  
Date  
Stamp

The general course of this claim is East To West and it is situated in Graham

County, Arizona. This claim is 1450 feet in length and 600 feet in width.

20.0 Total Claim Acreage. This claim runs from the location monument on which this location notice

is posted on the centerline of the claim approximately 10 feet in a Easterly direction to the East

end line and 1440 feet in a Westerly direction to the West end line. This claim is marked by six

monuments, one at each corner and one at the center of each end line of the claim.

The location monument on which this notice is posted is situated within Section 24 Township 5

S, Range 25 E, Gila Salt River Base and Meridian, Arizona and this claim encompasses portions

of the following quarter section(s), section(s), Township(s) and Range(s) NW 1/4

Section 24 Township 5S Range 25E and NE 1/4 Section 23 Township 5S Range 25E

Gila Salt River Base and Meridian, Arizona.

The locality of this claim with reference to some natural object or permanent monument and additional information

(if any) concerning its locality are as follows: The Northeast corner of the claim is 1321' South and 4250' West of the monument at the

Northeast Corner of Section 24, Township 5S, Range 25E

The above information is shown on the attached map.

DATED AND POSTED on the ground this 8 day of April, 2015.

LOCATOR(s)       AGENT

Print Name(s) Entellus, Inc. - Daniel G. Francetic, RLS

Signature(s) *Daniel G. Francetic*

Form MCF100  
Revised July 2014

This form is available from the Arizona Geological Survey and may be reproduced.

AMC432171

# RED BULL - 466 CLAIM

## LOCATION OF RED BULL-433 THROUGH RED BULL-468 LODE CLAIMS

LOCATED IN SECTIONS 23, 24, & 25 T.5S., R.25E., SECTIONS 19 & 30, T.5S., R.26E.  
GRAHAM COUNTY, ARIZONA

ALL CLAIMS ARE 1450' IN LENGTH AND  
600' IN WIDTH UNLESS NOTED

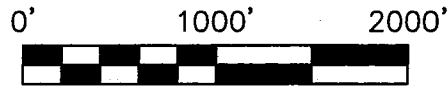
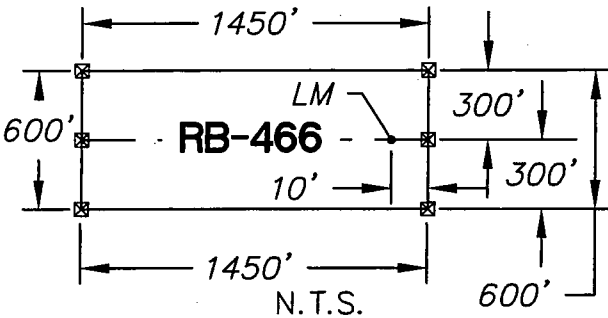
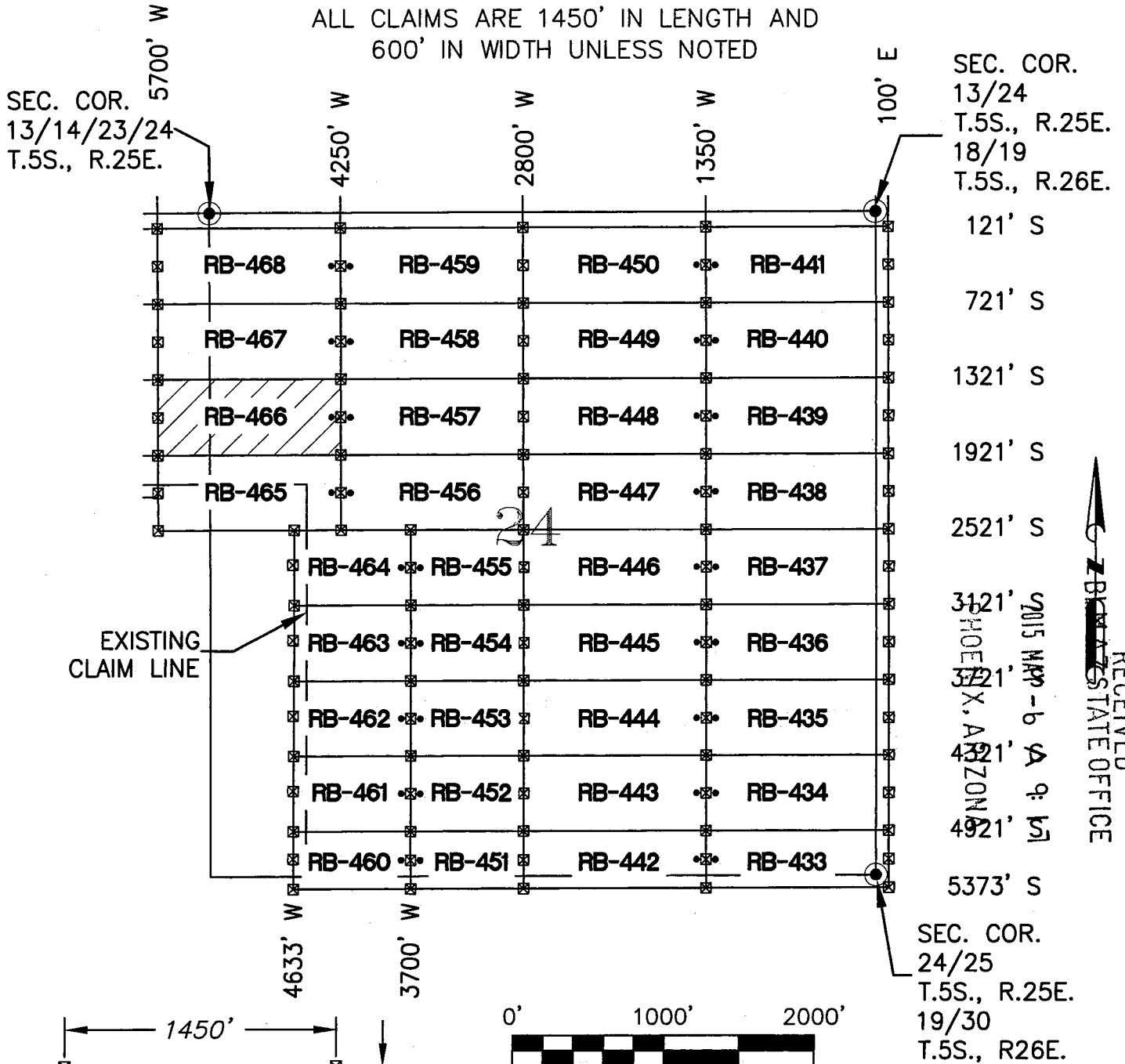

- ☒ INDICATES CORNER OF LODE CLAIM. SET 2"x2"x5' WOODEN POST (TYPICAL)
- INDICATES LOCATION MONUMENT. SET 2"x2"x5' WOODEN POST WITH SIGN (TYPICAL)

LOCATORS:  
FREEPORT MINERALS CORP.  
PO BOX 1019  
SAFFORD AZ 85548

CLAIM ACREAGE = 20.0 AC  
WC = WITNESS CORNER NORTH  
OF SIDE LINE

**Entellus™**  
2255 N. 44th Street Suite 125  
Phoenix, AZ 85008.3279  
Tel 602.244.2566  
Fax 602.244.8947  
Website: www.Entellus.com

RECEIVED  
ARIZONA STATE OFFICE

RECEIVED  
BLM AZ STATE OFFICE  
2015 MAY -6 A 9:17  
PHOENIX, ARIZONA

LOCATION NOTICE FOR LODE MINING CLAIM

Amendment BLM Serial # \_\_\_\_\_

NOTICE IS HEREBY GIVEN that the Red Bull - 467

\_\_\_\_\_ lode mining claim has been located  
by Freeport Minerals Corporation whose current mailing  
address is P.O. Box 1019  
Safford, Arizona 85548

BLM  
Date  
Stamp

The general course of this claim is East To West and it is situated in Graham  
County, Arizona. This claim is 1450 feet in length and 600 feet in width.

20.0 Total Claim Acreage. This claim runs from the location monument on which this location notice  
is posted on the centerline of the claim approximately 10 feet in a Easterly direction to the East  
end line and 1440 feet in a Westerly direction to the West end line. This claim is marked by six  
monuments, one at each corner and one at the center of each end line of the claim.

The location monument on which this notice is posted is situated within Section 24 Township 5  
S, Range 25 E, Gila Salt River Base and Meridian, Arizona and this claim encompasses portions

of the following quarter section(s), section(s), Township(s) and Range(s): NW 1/4

Section 24 Township 5S Range 25E and NE 1/4 Section 23 Township 5S Range 25E  
Gila Salt River Base and Meridian, Arizona.

The locality of this claim with reference to some natural object or permanent monument and additional information  
(if any) concerning its locality are as follows: The Northeast corner of the claim is 721' South and 4250' West of the monument at the  
Northeast Corner of Section 24, Township 5S, Range 25E

The above information is shown on the attached map.

DATED AND POSTED on the ground this 8 day of April, 2015

LOCATOR(s)  AGENT

Print Name(s) Entellus, Inc. - Daniel G. Francetic, RLS

Signature(s) *Daniel G. Francetic*

Form MCF100  
Revised July 2014

AMC432172

# RED BULL - 467 CLAIM

## LOCATION OF RED BULL-433 THROUGH RED BULL-468 LODE CLAIMS

LOCATED IN SECTIONS 23, 24, & 25 T.5S., R.25E., SECTIONS 19 & 30, T.5S., R.26E.  
GRAHAM COUNTY, ARIZONA

ALL CLAIMS ARE 1450' IN LENGTH AND  
600' IN WIDTH UNLESS NOTED

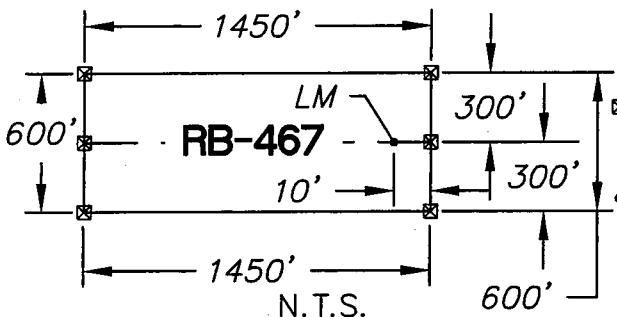
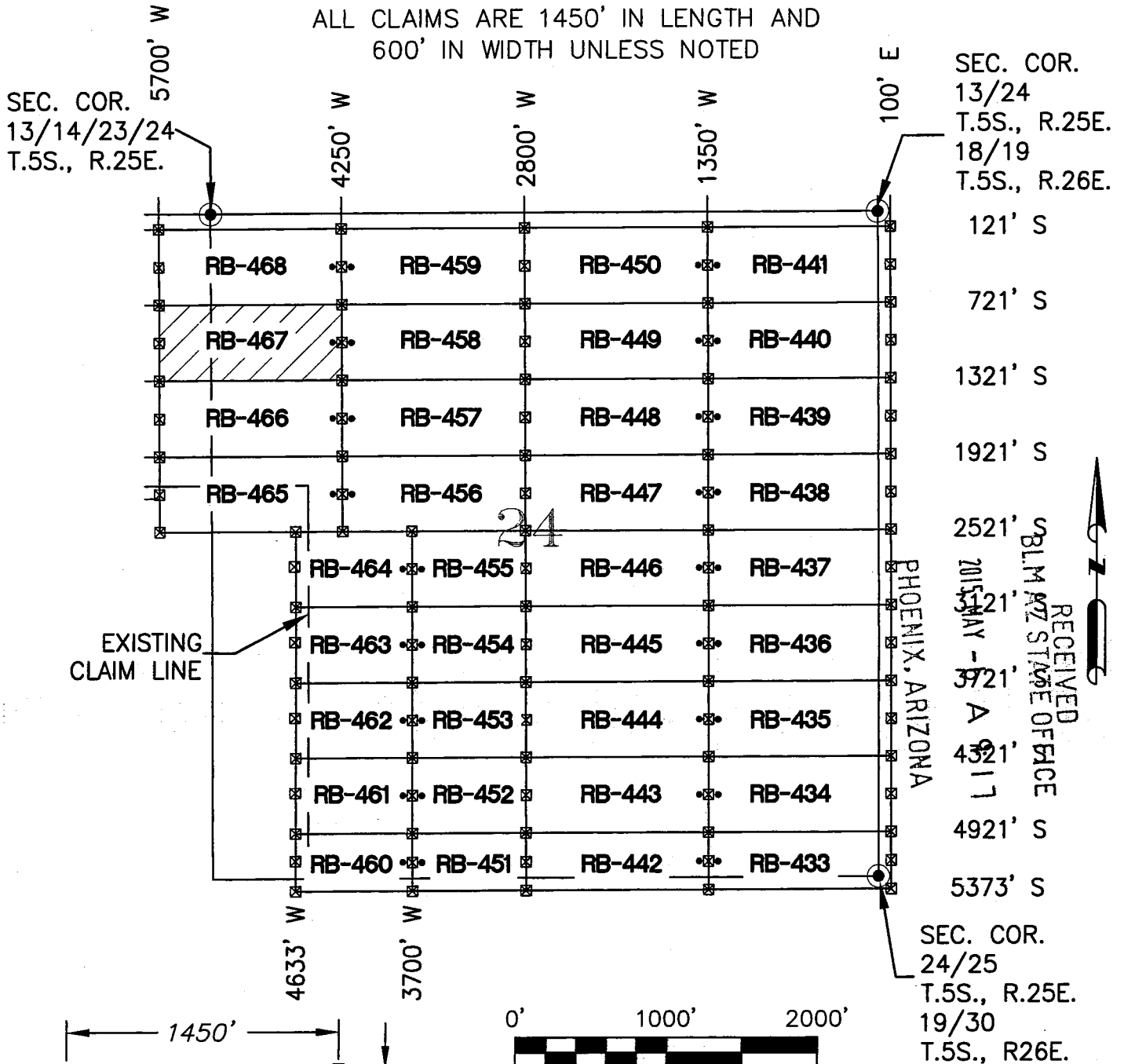

- INDICATES CORNER OF LODE CLAIM. SET 2"x2"x5' WOODEN POST (TYPICAL)
- INDICATES LOCATION MONUMENT. SET 2"x2"x5' WOODEN POST WITH SIGN (TYPICAL)

LOCATORS:  
FREEPORT MINERALS CORP.  
PO BOX 1019  
SAFFORD AZ 85548

CLAIM ACREAGE = 20.0 AC  
WC = WITNESS CORNER NORTH  
OF SIDE LINE

**Entellus™**  
2255 N. 44th Street Suite 125  
Phoenix, AZ 85008.3279  
Tel 602.244.2566  
Fax 602.244.8947  
Website: www.Entellus.com

RECEIVED  
BLM AZ STATE OFFICE  
2015 MAY -6 A 9:16  
PHOENIX, ARIZONA

LOCATION NOTICE FOR LODE MINING CLAIM

Amendment BLM Serial # \_\_\_\_\_

NOTICE IS HEREBY GIVEN that the Red Bull - 468

\_\_\_\_\_ lode mining claim has been located  
by Freeport Minerals Corporation whose current mailing  
address is P.O. Box 1019  
Safford, Arizona 85548

BLM  
Date  
Stamp

The general course of this claim is East To West and it is situated in Graham  
County, Arizona. This claim is 1450 feet in length and 600 feet in width.

20.0 Total Claim Acreage. This claim runs from the location monument on which this location notice  
is posted on the centerline of the claim approximately 10 feet in a Easterly direction to the East  
end line and 1440 feet in a Westerly direction to the West end line. This claim is marked by six  
monuments, one at each corner and one at the center of each end line of the claim.

The location monument on which this notice is posted is situated within Section 24 Township 5  
S, Range 25 E, Gila Salt River Base and Meridian, Arizona and this claim encompasses portions  
of the following quarter section(s), section(s), Township(s) and Range(s) NW 1/4  
Section 24 Township 5S Range 25E and NE 1/4 Section 23 Township 5S Range 25E

Gila Salt River Base and Meridian, Arizona.

The locality of this claim with reference to some natural object or permanent monument and additional information  
(if any) concerning its locality are as follows: The Northeast corner of the claim is 121' South and 4250' West of the monument at the  
Northeast Corner of Section 24, Township 5S, Range 25E

The above information is shown on the attached map.

DATED AND POSTED on the ground this 8 day of April, 2015

LOCATOR(s)  AGENT

Print Name(s) Entellus, Inc. - Daniel G. Francetic, RLS

Signature(s) *Daniel G. Francetic*

Form MCF100  
Revised July 2014

AM0432173

# RED BULL - 468 CLAIM

## LOCATION OF RED BULL-433 THROUGH RED BULL-468 LODE CLAIMS

LOCATED IN SECTIONS 23, 24, & 25 T.5S., R.25E., SECTIONS 19 & 30, T.5S., R.26E.  
GRAHAM COUNTY, ARIZONA

ALL CLAIMS ARE 1450' IN LENGTH AND  
600' IN WIDTH UNLESS NOTED

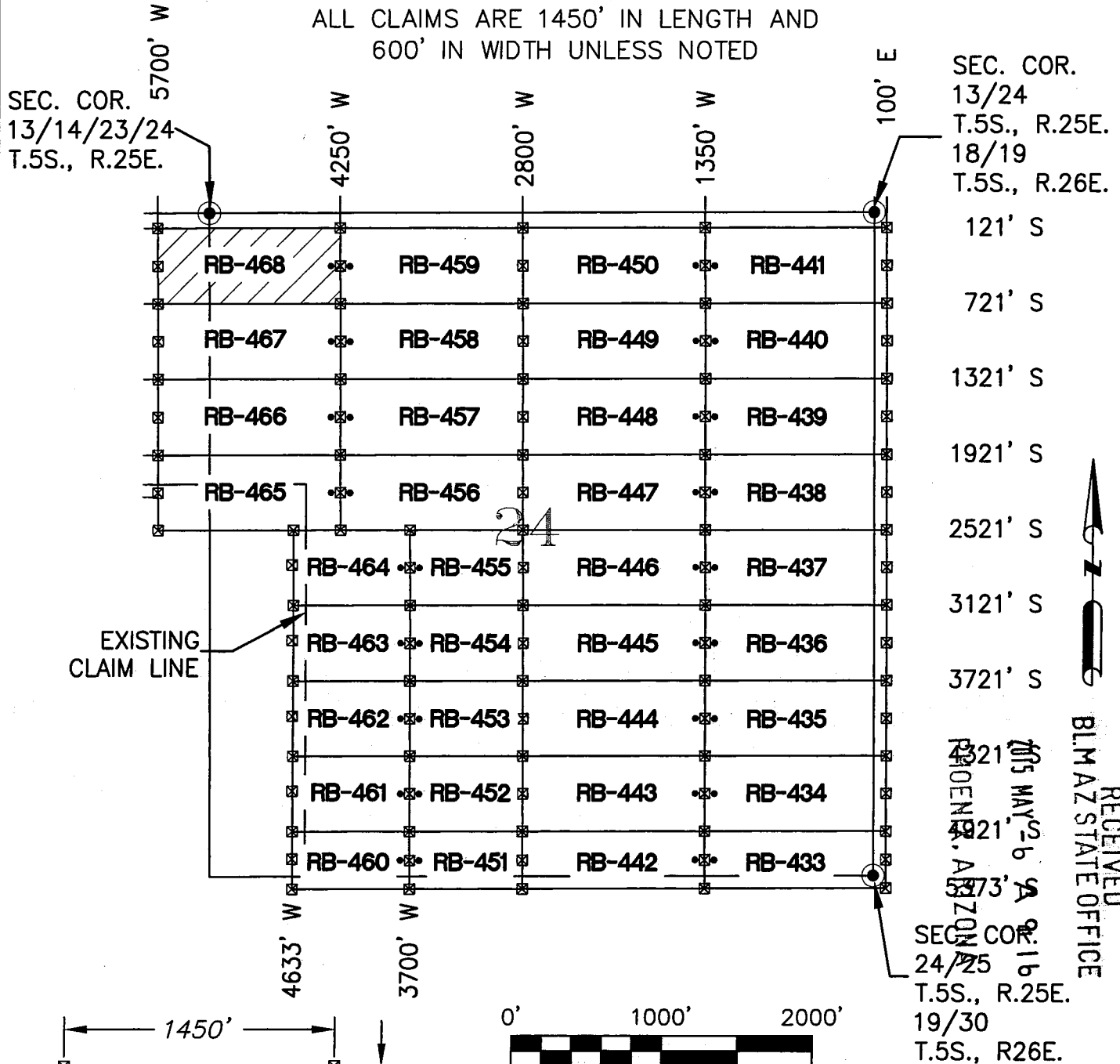

EXISTING CLAIM LINE

24

RECEIVED  
BLM AZ STATE OFFICE

2015 MAY 26  
GENERAL ARIZONA  
SECTION CORNER  
24/25  
T.5S., R.25E.  
19/30  
T.5S., R.26E.

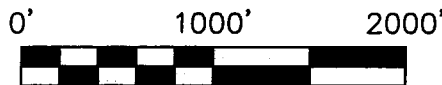
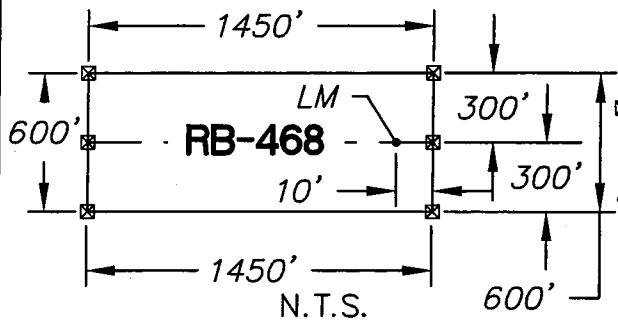

☒ INDICATES CORNER OF LODE CLAIM.  
SET 2"x2"x5' WOODEN POST (TYPICAL)

• INDICATES LOCATION  
MONUMENT. SET 2"x2"x5'  
WOODEN POST WITH SIGN  
(TYPICAL)

LOCATORS:  
FREEPORT MINERALS CORP.  
PO BOX 1019  
SAFFORD AZ 85548

CLAIM ACREAGE = 20.0 AC  
WC = WITNESS CORNER NORTH  
OF SIDE LINE

 **Entellus™**  
2255 N. 44th Street Suite 125  
Phoenix, AZ 85008.3279  
Tel 602.244.2566  
Fax 602.244.8947  
Website: www.Entellus.com

**LOCATION NOTICE FOR LODE MINING CLAIM**

Amendment      BLM Serial # \_\_\_\_\_

NOTICE IS HEREBY GIVEN that the Red Bull - 485

\_\_\_\_\_ lode mining claim has been located

by Freeport Minerals Corporation whose current mailing

address is P.O. Box 1019

\_\_\_\_\_ Safford, Arizona 85548

The general course of this claim is North to South and it is situated in \_\_\_\_\_ Graham

County, Arizona. This claim is 1450 feet in length and 475 feet in width.

15.8 Total Claim Acreage. This claim runs from the location monument on which this location notice

is posted on the centerline of the claim approximately 10 feet in a Northerly direction to the North

end line and 1440 feet in a Southerly direction to the South end line. This claim is marked by six

monuments, one at each corner and one at the center of each end line of the claim.

The location monument on which this notice is posted is situated within Section 25 Township 5

S, Range 26 E, Gila Salt River Base and Meridian, Arizona and this claim encompasses portions

of the following quarter section(s), section(s), Township(s) and Range(s) SE 1/4 Section 25, NE 1/4 Section 36 Township 5S Range 26E

NW 1/4 Section 31, SW 1/4 Section 30 Township 5S Range 27E

Gila Salt River Base and Meridian, Arizona.

The locality of this claim with reference to some natural object or permanent monument and additional information

(if any) concerning its locality are as follows: The Northeast corner of the claim is 3958' South and 100' East of the monument at the

Northeast Corner of Section 25, Township 5S, Range 26E

The above information is shown on the attached map.

DATED AND POSTED on the ground this 17 day of April, 2015

LOCATOR(s)       AGENT

Print Name(s) Entellus, Inc. - Daniel G. Francetic, RLS

Signature(s) *Daniel G. Francetic*

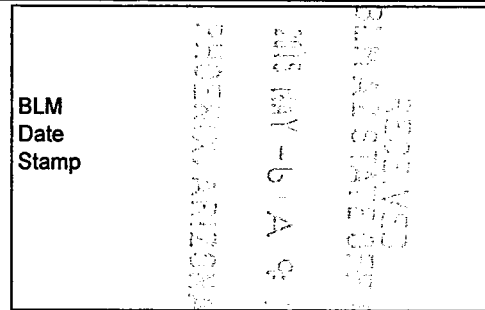

AMC432174

Form MCF100  
Revised July 2014



# RED BULL - 485 CLAIM

LOCATION OF RED BULL-485 THROUGH RED BULL-492 LODE CLAIMS  
 LOCATED IN SECTIONS 24, 25, 36, T.5S., R.26E. AND  
 SECTIONS 19, & 30, 31, T.5S., R.27E.  
 GRAHAM COUNTY, ARIZONA

ALL CLAIMS ARE 1450' IN LENGTH AND  
 600' IN WIDTH UNLESS NOTED

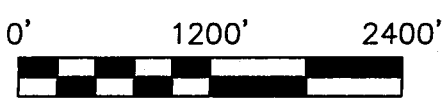
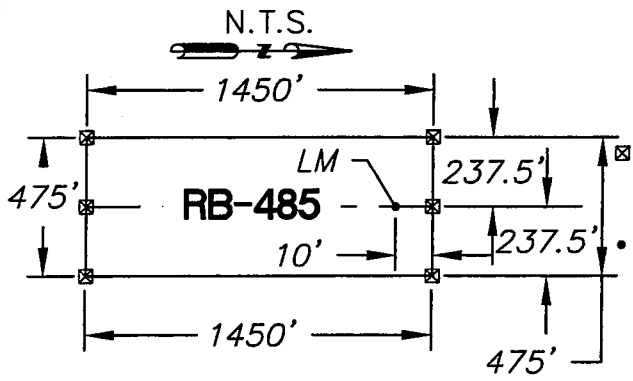
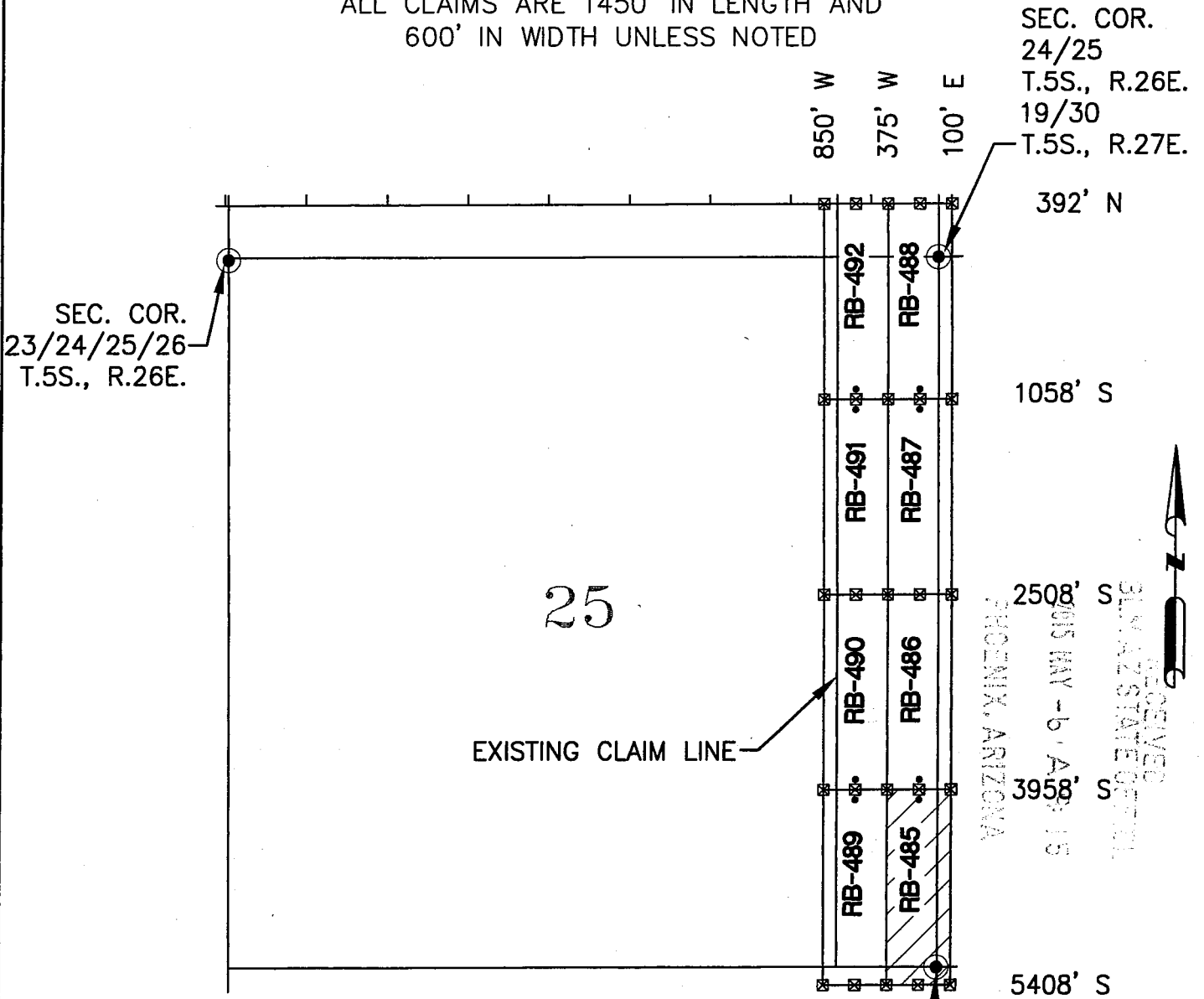

INDICATES CORNER OF LODE CLAIM.  
 SET 2"x2"x5' WOODEN POST (TYPICAL)

INDICATES LOCATION  
 MONUMENT. SET 2"x2"x5'  
 WOODEN POST WITH SIGN  
 (TYPICAL)

LOCATORS:  
 FREEPORT MINERALS CORP.  
 PO BOX 1019  
 SAFFORD AZ 85548

CLAIM ACREAGE = 15.8 AC  
 WC = WITNESS CORNER NORTH  
 OF SIDE LINE

**Entellus™**  
 2255 N. 44th Street Suite 125  
 Phoenix, AZ 85008.3279  
 Tel 602.244.2566  
 Fax 602.244.8947  
 Website: www.Entellus.com

RECEIVED  
 31 MAY 2015  
 PHOENIX, ARIZONA

AMC 432174

**LOCATION NOTICE FOR LODE MINING CLAIM**

Amendment      BLM Serial # \_\_\_\_\_

NOTICE IS HEREBY GIVEN that the Red Bull - 486

\_\_\_\_\_ lode mining claim has been located

by Freeport Minerals Corporation whose current mailing

address is P.O. Box 1019

Safford, Arizona 85548

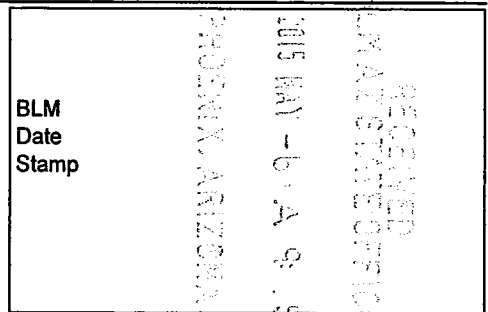

The general course of this claim is North to South and it is situated in Graham

County, Arizona. This claim is 1450 feet in length and 475 feet in width.

15.8 Total Claim Acreage. This claim runs from the location monument on which this location notice is posted on the centerline of the claim approximately 10 feet in a Southerly direction to the South end line and 1440 feet in a Northerly direction to the North end line. This claim is marked by six monuments, one at each corner and one at the center of each end line of the claim.

The location monument on which this notice is posted is situated within Section 25 Township 5

S, Range 26 E, Gila Salt River Base and Meridian, Arizona and this claim encompasses portions

of the following quarter section(s), section(s), Township(s) and Range(s) SE 1/4, NE 1/4 Section 25 Township 5S Range 26E

SW 1/4, NW 1/4 Section 30 Township 5S Range 27E

Gila Salt River Base and Meridian, Arizona.

The locality of this claim with reference to some natural object or permanent monument and additional information

(if any) concerning its locality are as follows: The Northeast corner of the claim is 2508' South and 100' East of the monument at the

Northeast Corner of Section 25, Township 5S, Range 26E

The above information is shown on the attached map.

DATED AND POSTED on the ground this 17 day of April, 2015.

LOCATOR(s)       AGENT

Print Name(s) Entellus, Inc. - Daniel G. Francetic, RLS

Signature(s) [Handwritten Signature]

Form MCF100  
Revised July 2014

AMC432178

# RED BULL - 486 CLAIM

LOCATION OF RED BULL-485 THROUGH RED BULL-492 LODE CLAIMS  
 LOCATED IN SECTIONS 24, 25, 36, T.5S., R.26E. AND  
 SECTIONS 19, & 30, 31, T.5S., R.27E.  
 GRAHAM COUNTY, ARIZONA

ALL CLAIMS ARE 1450' IN LENGTH AND  
 600' IN WIDTH UNLESS NOTED

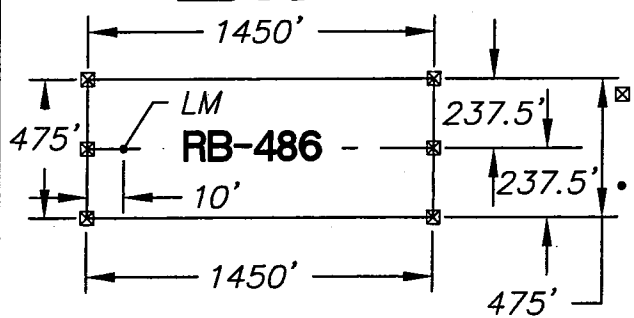
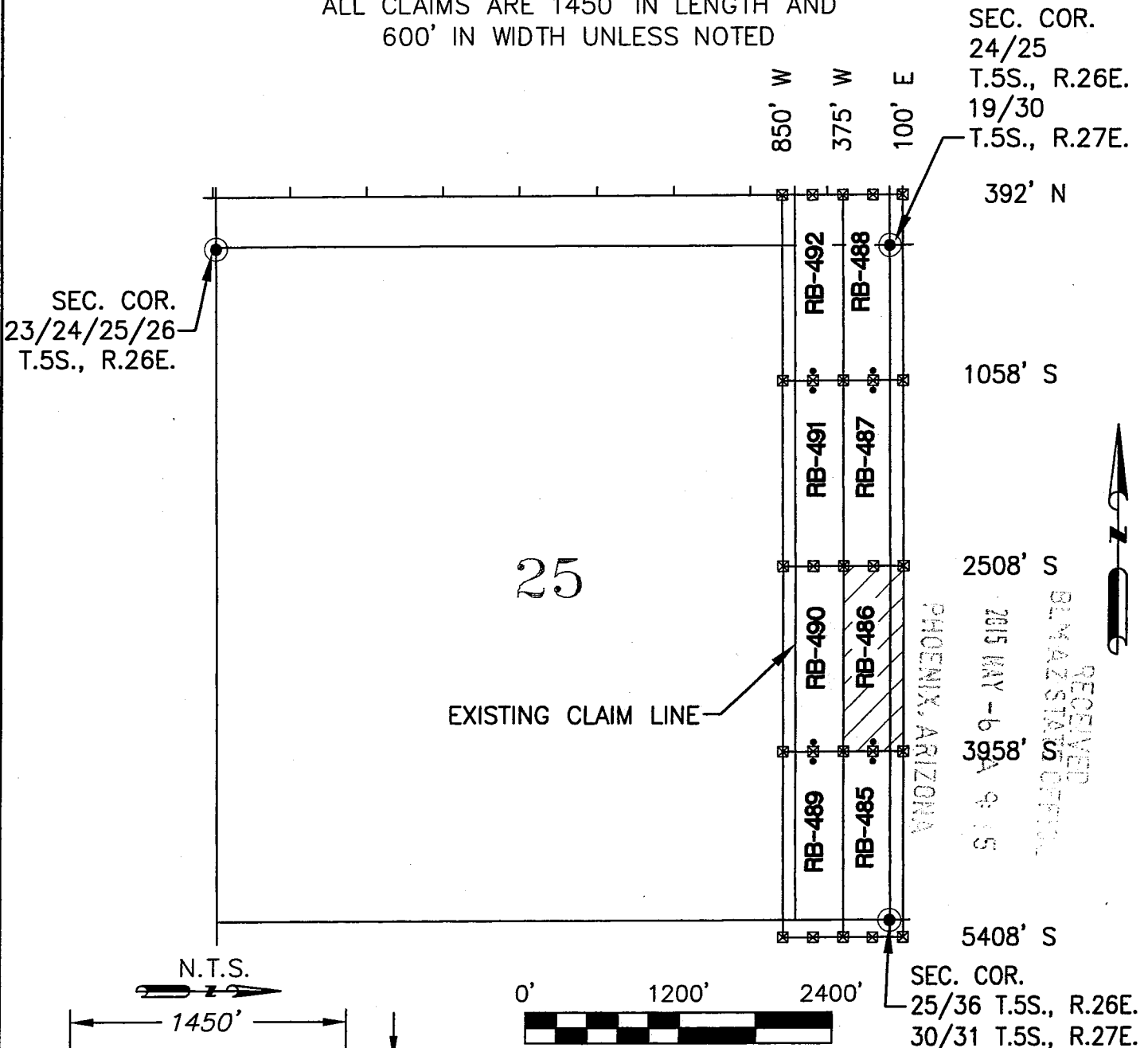

INDICATES CORNER OF LODE CLAIM.  
 SET 2"x2"x5' WOODEN POST (TYPICAL)

INDICATES LOCATION  
 MONUMENT. SET 2"x2"x5'  
 WOODEN POST WITH SIGN  
 (TYPICAL)

LOCATORS:  
 FREEPORT MINERALS CORP.  
 PO BOX 1019  
 SAFFORD AZ 85548

CLAIM ACREAGE = 15.8 AC  
 WC = WITNESS CORNER NORTH  
 OF SIDE LINE

**Entellus**<sup>™</sup>

2255 N. 44th Street Suite 125  
 Phoenix, AZ 85008.3279  
 Tel 602.244.2566  
 Fax 602.244.8947  
 Website: www.Entellus.com

LOCATION NOTICE FOR LODE MINING CLAIM

Amendment BLM Serial # \_\_\_\_\_

NOTICE IS HEREBY GIVEN that the Red Bull - 487

\_\_\_\_\_ lode mining claim has been located

by Freeport Minerals Corporation whose current mailing

address is P.O. Box 1019

Safford, Arizona 85548

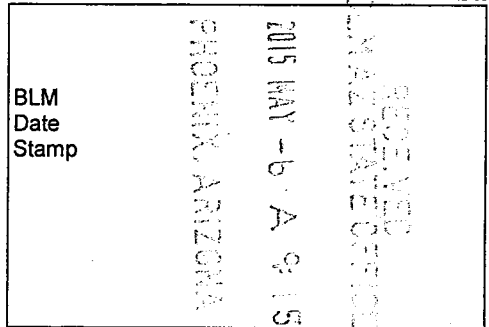

The general course of this claim is North to South and it is situated in \_\_\_\_\_ Graham

County, Arizona. This claim is 1450 feet in length and 475 feet in width.

15.8 Total Claim Acreage. This claim runs from the location monument on which this location notice

is posted on the centerline of the claim approximately 10 feet in a Northerly direction to the North

end line and 1440 feet in a Southerly direction to the South end line. This claim is marked by six

monuments, one at each corner and one at the center of each end line of the claim.

The location monument on which this notice is posted is situated within Section 25 Township 5

S, Range 26 E, Gila Salt River Base and Meridian, Arizona and this claim encompasses portions

of the following quarter section(s), section(s), Township(s) and Range(s) NE 1/4 Section 25 Township 5S Range 26E

NW 1/4 Section 30 Township 5S Range 27E

Gila Salt River Base and Meridian, Arizona.

The locality of this claim with reference to some natural object or permanent monument and additional information

(if any) concerning its locality are as follows: The Northeast corner of the claim is 1058' South and 100' East of the monument at the

Northeast Corner of Section 25, Township 5S, Range 26E

The above information is shown on the attached map.

DATED AND POSTED on the ground this 17 day of April, 2015.

LOCATOR(s)  AGENT

Print Name(s) Entellus, Inc. - Daniel G. Francetic, RLS

Signature(s) *Daniel G. Francetic*

Form MCF100 Revised July 2014

AMC432176

# RED BULL - 487 CLAIM

LOCATION OF RED BULL-485 THROUGH RED BULL-492 LODE CLAIMS  
 LOCATED IN SECTIONS 24, 25, 36, T.5S., R.26E. AND  
 SECTIONS 19, & 30, 31, T.5S., R.27E.  
 GRAHAM COUNTY, ARIZONA  
 ALL CLAIMS ARE 1450' IN LENGTH AND  
 600' IN WIDTH UNLESS NOTED

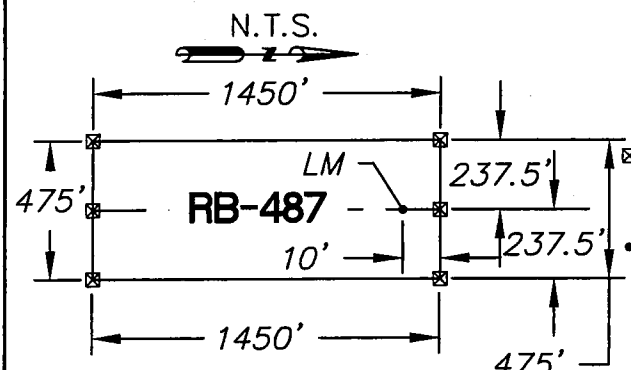
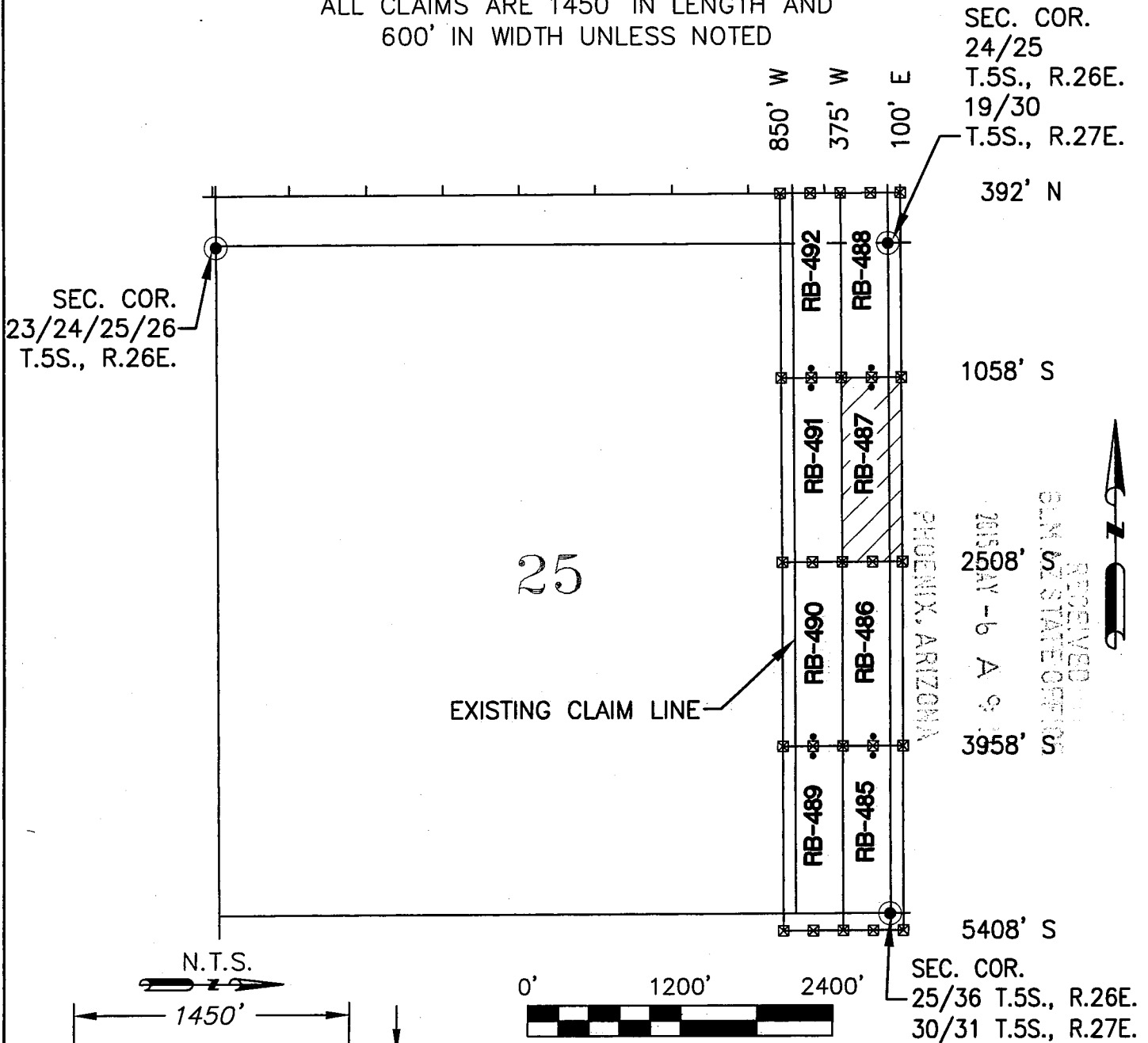

INDICATES CORNER OF LODE CLAIM.  
 SET 2"x2"x5' WOODEN POST (TYPICAL)

INDICATES LOCATION  
 MONUMENT. SET 2"x2"x5'  
 WOODEN POST WITH SIGN  
 (TYPICAL)

LOCATORS:  
 FREEPORT MINERALS CORP.  
 PO BOX 1019  
 SAFFORD AZ 85548

CLAIM ACREAGE = 15.8 AC  
 WC = WITNESS CORNER NORTH  
 OF SIDE LINE

**Entellus™**  
 2255 N. 44th Street Suite 125  
 Phoenix, AZ 85008.3279  
 Tel 602.244.2566  
 Fax 602.244.8947  
 Website: www.Entellus.com

RECEIVED  
 G.L.M. STATE OFFICES  
 MAY 6 9 - 11 5102  
 PHOENIX, ARIZONA

**LOCATION NOTICE FOR LODE MINING CLAIM**

Amendment BLM Serial # \_\_\_\_\_

NOTICE IS HEREBY GIVEN that the Red Bull - 488

\_\_\_\_\_ lode mining claim has been located

by Freeport Minerals Corporation whose current mailing

address is P.O. Box 1019

Safford, Arizona 85548

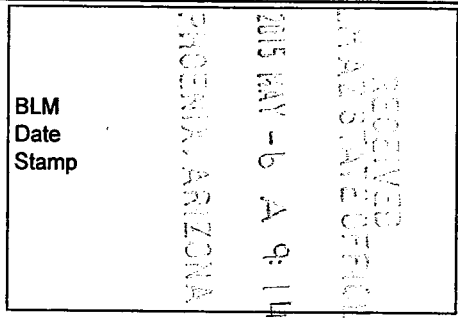

The general course of this claim is North to South and it is situated in \_\_\_\_\_ Graham

County, Arizona. This claim is 1450 feet in length and 475 feet in width.

15.8 Total Claim Acreage. This claim runs from the location monument on which this location notice is posted on the centerline of the claim approximately 10 feet in a Southerly direction to the South end line and 1440 feet in a Northerly direction to the North end line. This claim is marked by six monuments, one at each corner and one at the center of each end line of the claim.

The location monument on which this notice is posted is situated within Section 25 Township 5

S, Range 26 E, Gila Salt River Base and Meridian, Arizona and this claim encompasses portions

of the following quarter section(s), section(s), Township(s) and Range(s) NE 1/4 Section 25 Township 5S Range 26E

NW 1/4 Section 30 Township 5S Range 27E, SW 1/4 Section 19 Township 5S Range 27E, SE1/4 Section 24 Township 5S Range 26E

Gila Salt River Base and Meridian, Arizona.

The locality of this claim with reference to some natural object or permanent monument and additional information

(if any) concerning its locality are as follows: The Northeast corner of the claim is 392' North and 100' East of the monument at the

Northeast Corner of Section 25, Township 5S, Range 26E

The above information is shown on the attached map.

DATED AND POSTED on the ground this 17 day of April, 2015.

LOCATOR(s)  AGENT

Print Name(s) Entellus, Inc. - Daniel G. Francetic, RLS

Signature(s) *Daniel G. Francetic*

Form MCF100 Revised July 2014

AMC4321771

# RED BULL - 488 CLAIM

LOCATION OF RED BULL-485 THROUGH RED BULL-492 LODE CLAIMS

LOCATED IN SECTIONS 24, 25, 36, T.5S., R.26E. AND

SECTIONS 19, & 30, 31, T.5S., R.27E.

GRAHAM COUNTY, ARIZONA

ALL CLAIMS ARE 1450' IN LENGTH AND

600' IN WIDTH UNLESS NOTED

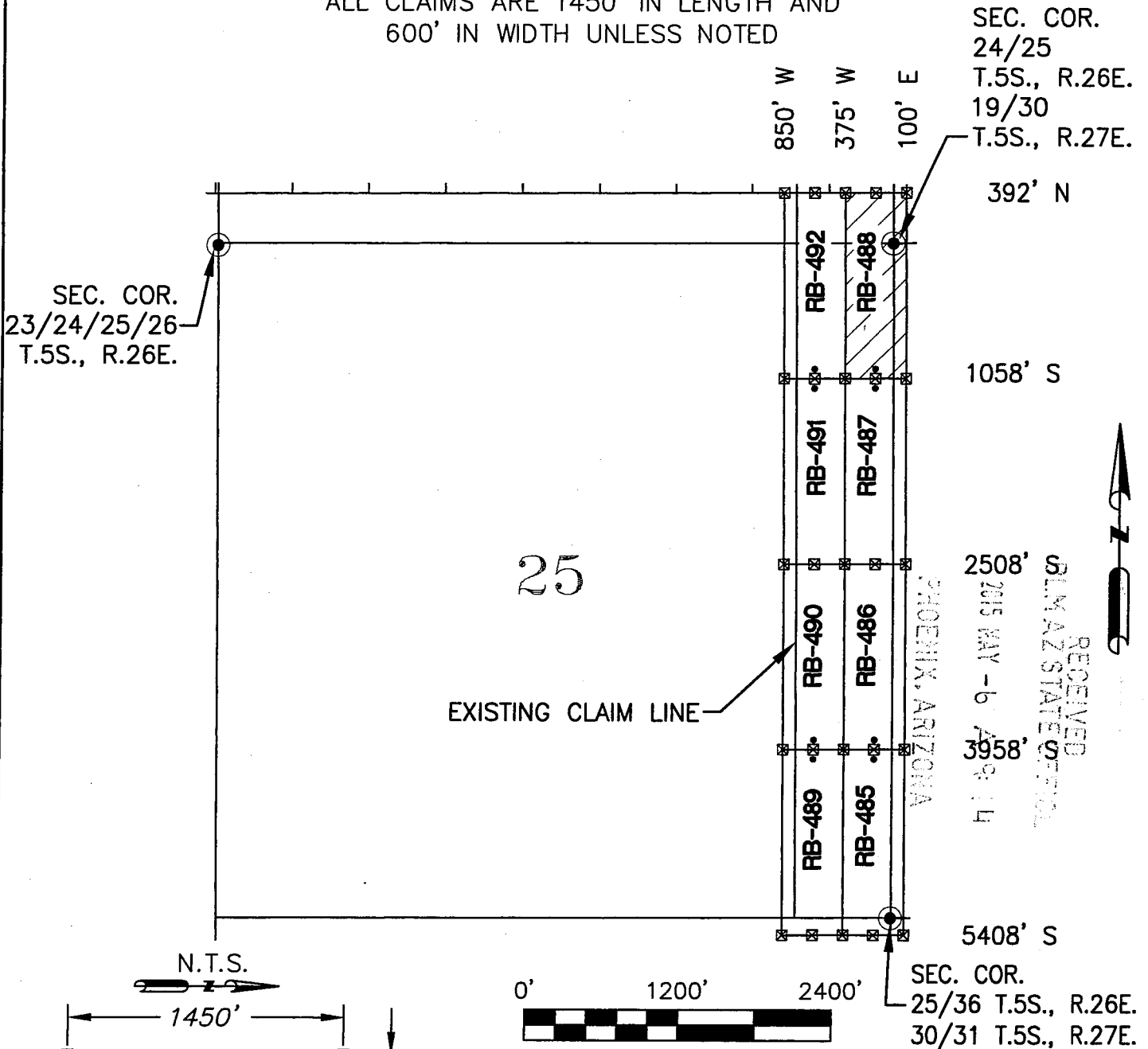

SEC. COR.  
23/24/25/26  
T.5S., R.26E.

SEC. COR.  
24/25  
T.5S., R.26E.  
19/30  
T.5S., R.27E.

25

EXISTING CLAIM LINE

PHOENIX, ARIZONA

392' N  
1058' S  
2508'  
3958'  
5408' S

SEC. COR.  
25/36 T.5S., R.26E.  
30/31 T.5S., R.27E.

RECEIVED  
BLM AZ STATE OFFICE  
2015 MAY - 6 AM 11:14

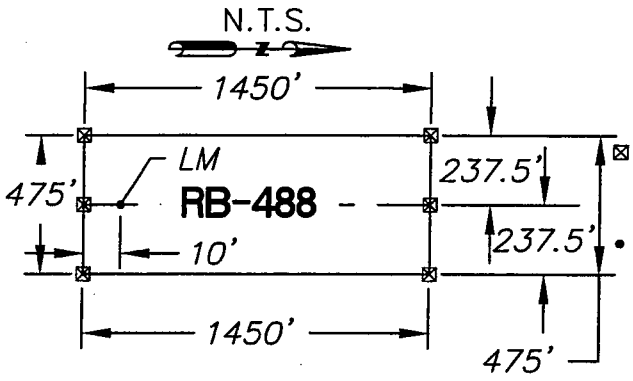

INDICATES CORNER OF LODE CLAIM.  
SET 2"x2"x5' WOODEN POST (TYPICAL)

INDICATES LOCATION  
MONUMENT. SET 2"x2"x5'  
WOODEN POST WITH SIGN  
(TYPICAL)

LOCATORS:  
FREEPORT MINERALS CORP.  
PO BOX 1019  
SAFFORD AZ 85548

CLAIM ACREAGE = 15.8 AC  
WC = WITNESS CORNER NORTH  
OF SIDE LINE

**Entellus™**  
2255 N. 44th Street Suite 125  
Phoenix, AZ 85008.3279  
Tel 602.244.2566  
Fax 602.244.8947  
Website: www.Entellus.com

LOCATION NOTICE FOR LODE MINING CLAIM

Amendment BLM Serial # \_\_\_\_\_

NOTICE IS HEREBY GIVEN that the Red Bull - 489

\_\_\_\_\_ lode mining claim has been located

by Freeport Minerals Corporation whose current mailing

address is P.O. Box 1019

Safford, Arizona 85548

RECEIVED  
BLM AZ STATE OFFICE  
2015 MAY -6 A 9:14  
PHOENIX, ARIZONA

BLM  
Date  
Stamp

The general course of this claim is North to South and it is situated in Graham

County, Arizona. This claim is 1450 feet in length and 475 feet in width.

15.8 Total Claim Acreage. This claim runs from the location monument on which this location notice

is posted on the centerline of the claim approximately 10 feet in a Northerly direction to the North

end line and 1440 feet in a Southerly direction to the South end line. This claim is marked by six

monuments, one at each corner and one at the center of each end line of the claim.

The location monument on which this notice is posted is situated within Section 25 Township 5

S, Range 26 E, Gila Salt River Base and Meridian, Arizona and this claim encompasses portions

of the following quarter section(s), section(s), Township(s) and Range(s) SE 1/4

Section 25 Township 5S Range 26E NE 1/4 Section 36 Township 5S Range 26E

Gila Salt River Base and Meridian, Arizona.

The locality of this claim with reference to some natural object or permanent monument and additional information

(if any) concerning its locality are as follows: The Northeast corner of the claim is 3958' South and 375' West of the monument at the

Northeast Corner of Section 25, Township 5S, Range 26E

The above information is shown on the attached map.

DATED AND POSTED on the ground this 17 day of April, 2015.

LOCATOR(s)  AGENT

Print Name(s) Entellus, Inc. - Daniel G. Francetic, RLS

Signature(s) *Daniel G. Francetic*

Form MCF100  
Revised July 2014

AMC432178



# RED BULL - 489 CLAIM

LOCATION OF RED BULL-485 THROUGH RED BULL-492 LODE CLAIMS  
 LOCATED IN SECTIONS 24, 25, 36, T.5S., R.26E. AND  
 SECTIONS 19, & 30, 31, T.5S., R.27E.  
 GRAHAM COUNTY, ARIZONA  
 ALL CLAIMS ARE 1450' IN LENGTH AND  
 600' IN WIDTH UNLESS NOTED

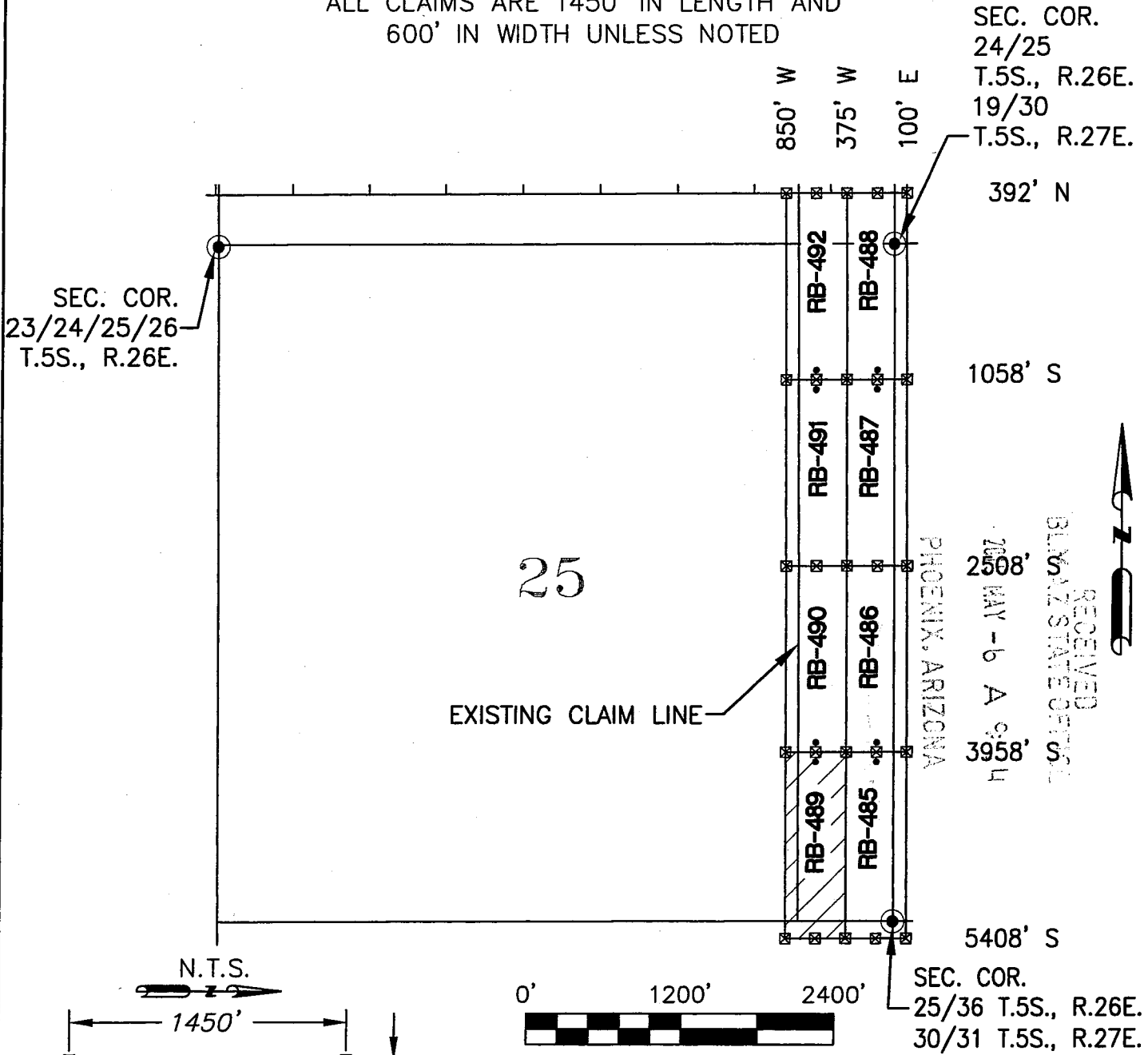

SEC. COR.  
 23/24/25/26  
 T.5S., R.26E.

SEC. COR.  
 24/25  
 T.5S., R.26E.  
 19/30  
 T.5S., R.27E.

25

EXISTING CLAIM LINE

392' N  
 1058' S  
 2508'  
 MAY - 6 A 9  
 3958' S  
 5408' S

PHOENIX, ARIZONA

RECEIVED  
 BLM STATE OFFICE



N.T.S.

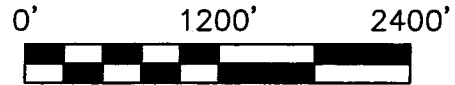

SEC. COR.  
 25/36 T.5S., R.26E.  
 30/31 T.5S., R.27E.

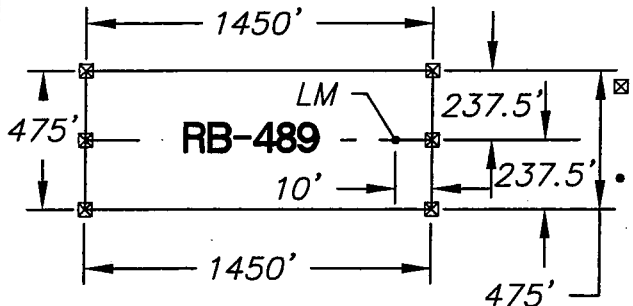

INDICATES CORNER OF LODE CLAIM.  
 SET 2"x2"x5' WOODEN POST (TYPICAL)  
 INDICATES LOCATION  
 MONUMENT. SET 2"x2"x5'  
 WOODEN POST WITH SIGN  
 (TYPICAL)

LOCATORS:  
 FREEPORT MINERALS CORP.  
 PO BOX 1019  
 SAFFORD AZ 85548

CLAIM ACREAGE = 15.8 AC  
 WC = WITNESS CORNER NORTH  
 OF SIDE LINE

**Entellus™**  
 2255 N. 44th Street Suite 125  
 Phoenix, AZ 85008.3279  
 Tel 602.244.2566  
 Fax 602.244.8947  
 Website: www.Entellus.com

LOCATION NOTICE FOR LODE MINING CLAIM

Amendment BLM Serial # \_\_\_\_\_

NOTICE IS HEREBY GIVEN that the Red Bull - 490  
\_\_\_\_\_ lode mining claim has been located  
by Freeport Minerals Corporation whose current mailing  
address is P.O. Box 1019  
Safford, Arizona 85548

RECEIVED  
BLM AZ STATE OFFICE  
2015 MAY -6 A 9:14  
PHOENIX, ARIZONA  
BLM  
Date  
Stamp

The general course of this claim is North to South and it is situated in Graham  
County, Arizona. This claim is 1450 feet in length and 475 feet in width.

15.8 Total Claim Acreage. This claim runs from the location monument on which this location notice  
is posted on the centerline of the claim approximately 10 feet in a Southerly direction to the South  
end line and 1440 feet in a Northerly direction to the North end line. This claim is marked by six  
monuments, one at each corner and one at the center of each end line of the claim.

The location monument on which this notice is posted is situated within Section 25 Township 5  
S, Range 26 E, Gila Salt River Base and Meridian, Arizona and this claim encompasses portions  
of the following quarter section(s), section(s), Township(s) and Range(s) SE 1/4 NE 1/4  
Section 25 Township 5S Range 26E

Gila Salt River Base and Meridian, Arizona.

The locality of this claim with reference to some natural object or permanent monument and additional information  
(if any) concerning its locality are as follows: The Northeast corner of the claim is 2508' South and 375' West of the monument at the  
Northeast Corner of Section 25, Township 5S, Range 26E

The above information is shown on the attached map.

DATED AND POSTED on the ground this 17 day of April, 2015.

LOCATOR(s)  AGENT

Print Name(s) Entellus, Inc. - Daniel G. Francetic, RLS

Signature(s) *Daniel G. Francetic*

Form MCF100  
Revised July 2014

ANCL 321791

# RED BULL - 490 CLAIM

LOCATION OF RED BULL-485 THROUGH RED BULL-492 LODE CLAIMS  
 LOCATED IN SECTIONS 24, 25, 36, T.5S., R.26E. AND  
 SECTIONS 19, & 30, 31, T.5S., R.27E.  
 GRAHAM COUNTY, ARIZONA  
 ALL CLAIMS ARE 1450' IN LENGTH AND  
 600' IN WIDTH UNLESS NOTED

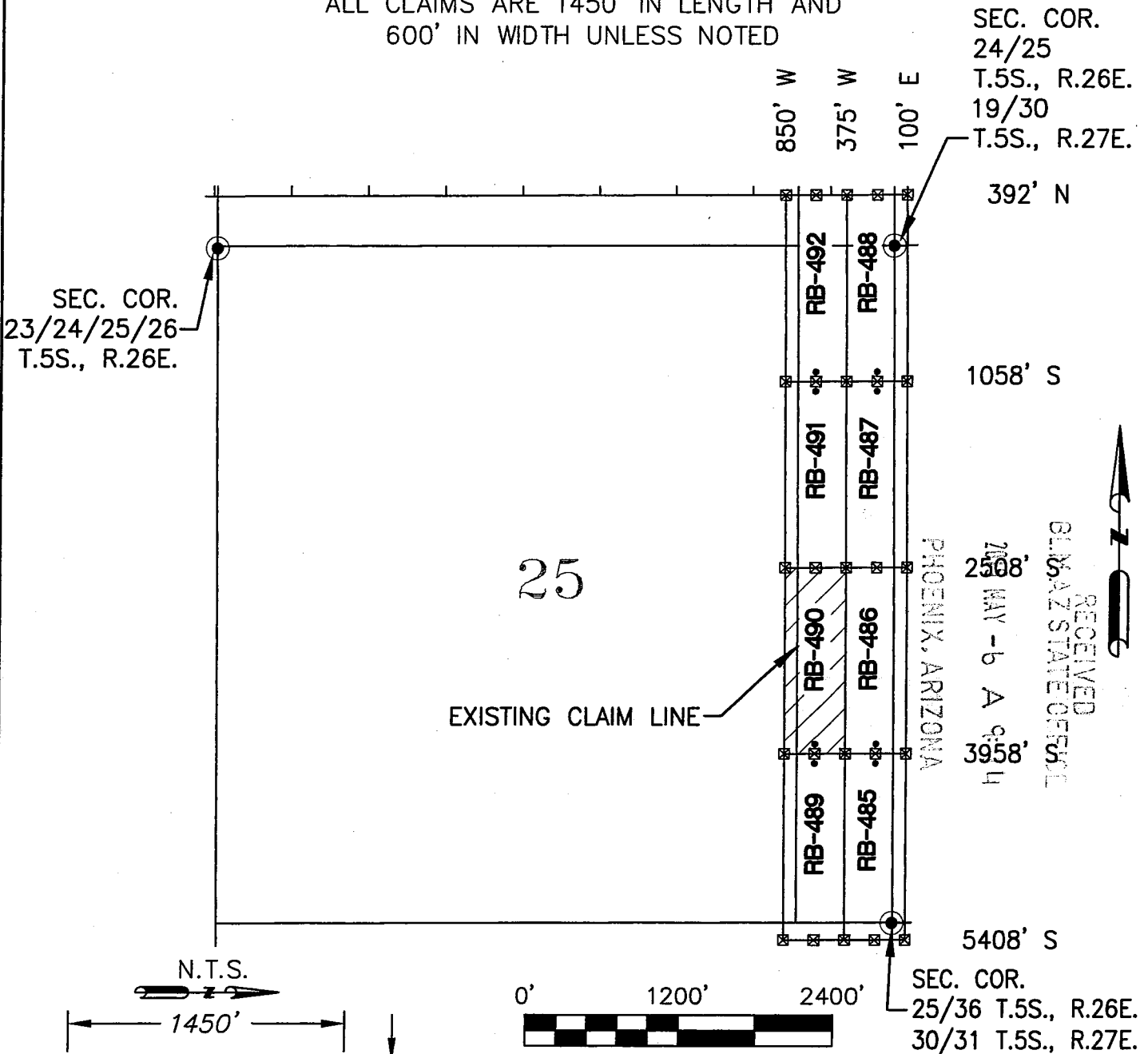

SEC. COR.  
 23/24/25/26  
 T.5S., R.26E.

SEC. COR.  
 24/25  
 T.5S., R.26E.  
 19/30  
 T.5S., R.27E.

25

EXISTING CLAIM LINE

RECEIVED  
 BLM AZ STATE OFFICE  
 MAY - 6 A 9:58 AM '11

PHOENIX, ARIZONA

N.T.S.

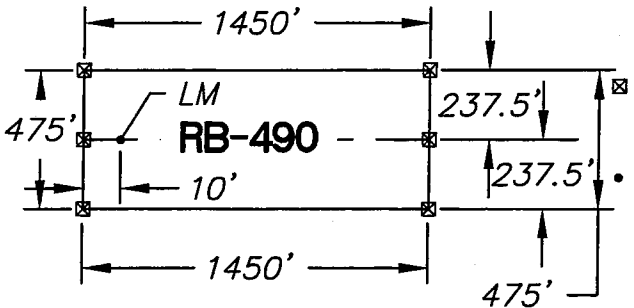

INDICATES CORNER OF LODE CLAIM.  
 SET 2"x2"x5' WOODEN POST (TYPICAL)  
 INDICATES LOCATION  
 MONUMENT. SET 2"x2"x5'  
 WOODEN POST WITH SIGN  
 (TYPICAL)

LOCATORS:  
 FREEPORT MINERALS CORP.  
 PO BOX 1019  
 SAFFORD AZ 85548

CLAIM ACREAGE = 15.8 AC  
 WC = WITNESS CORNER NORTH  
 OF SIDE LINE

**Entellus™**  
 2255 N. 44th Street Suite 125  
 Phoenix, AZ 85008.3279  
 Tel 602.244.2566  
 Fax 602.244.8947  
 Website: www.Entellus.com

LOCATION NOTICE FOR LODE MINING CLAIM

Amendment BLM Serial # \_\_\_\_\_

NOTICE IS HEREBY GIVEN that the Red Bull - 491  
\_\_\_\_\_ lode mining claim has been located  
by Freeport Minerals Corporation whose current mailing  
address is P.O. Box 1019  
Safford, Arizona 85548

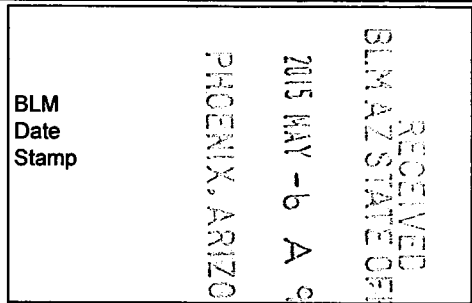

The general course of this claim is North to South and it is situated in \_\_\_\_\_  
County, Arizona. This claim is 1450 feet in length and 475 feet in width.

15.8 Total Claim Acreage. This claim runs from the location monument on which this location notice  
is posted on the centerline of the claim approximately 10 feet in a Northerly direction to the North  
end line and 1440 feet in a Southerly direction to the South end line. This claim is marked by six  
monuments, one at each corner and one at the center of each end line of the claim.

The location monument on which this notice is posted is situated within Section 25 Township 5  
S, Range 26 E, Gila Salt River Base and Meridian, Arizona and this claim encompasses portions  
of the following quarter section(s), section(s), Township(s) and Range(s) NE 1/4

Section 25 Township 5S Range 26E  
Gila Salt River Base and Meridian, Arizona.

The locality of this claim with reference to some natural object or permanent monument and additional information  
(if any) concerning its locality are as follows: The Northeast corner of the claim is 1058' South and 375' West of the monument at the  
Northeast Corner of Section 25, Township 5S, Range 26E

The above information is shown on the attached map.

DATED AND POSTED on the ground this 17 day of April, 2015.

LOCATOR(s)  AGENT

Print Name(s) Entellus, Inc. - Daniel G. Francetic, RLS  
Signature(s) *Daniel G. Francetic*

Form MCF100  
Revised July 2014

AMC432180

# RED BULL - 491 CLAIM

LOCATION OF RED BULL-485 THROUGH RED BULL-492 LODE CLAIMS  
 LOCATED IN SECTIONS 24, 25, 36, T.5S., R.26E. AND  
 SECTIONS 19, & 30, 31, T.5S., R.27E.  
 GRAHAM COUNTY, ARIZONA  
 ALL CLAIMS ARE 1450' IN LENGTH AND  
 600' IN WIDTH UNLESS NOTED

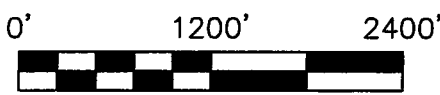
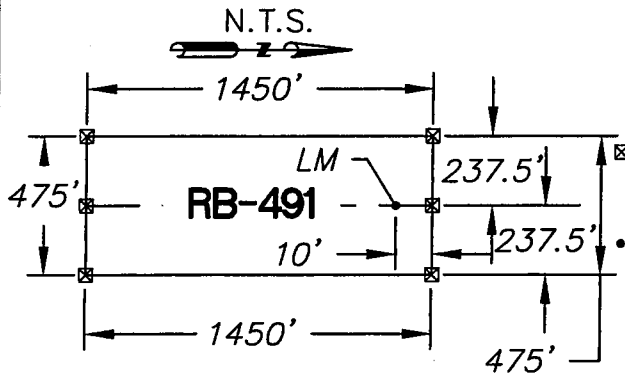
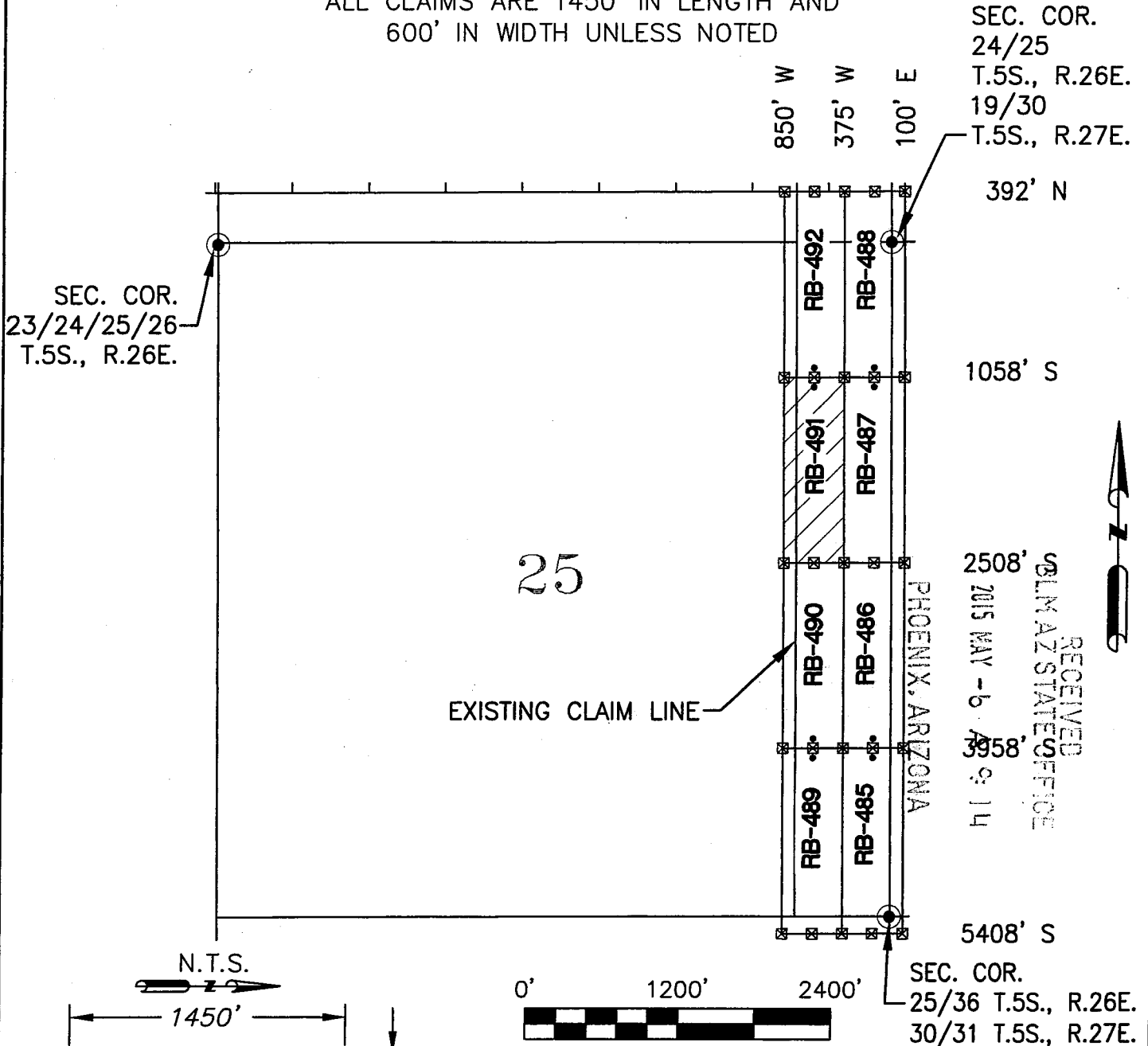

INDICATES CORNER OF LODE CLAIM.  
 SET 2"x2"x5' WOODEN POST (TYPICAL)  
 INDICATES LOCATION  
 MONUMENT. SET 2"x2"x5'  
 WOODEN POST WITH SIGN  
 (TYPICAL)

LOCATORS:  
 FREEPORT MINERALS CORP.  
 PO BOX 1019  
 SAFFORD AZ 85548

CLAIM ACREAGE = 15.8 AC  
 WC = WITNESS CORNER NORTH  
 OF SIDE LINE

SEC. COR.  
 24/25  
 T.5S., R.26E.  
 19/30  
 T.5S., R.27E.

SEC. COR.  
 23/24/25/26  
 T.5S., R.26E.

392' N

1058' S

25

EXISTING CLAIM LINE

2508'

3958'

5408' S

PHOENIX, ARIZONA

RECEIVED  
 CLM AZ STATE OFFICE  
 2015 MAY - 6 9 14

SEC. COR.  
 25/36 T.5S., R.26E.  
 30/31 T.5S., R.27E.



2255 N. 44th Street Suite 125  
 Phoenix, AZ 85008.3279  
 Tel 602.244.2566  
 Fax 602.244.8947  
 Website: www.Entellus.com

LOCATION NOTICE FOR LODE MINING CLAIM

Amendment BLM Serial # \_\_\_\_\_

NOTICE IS HEREBY GIVEN that the Red Bull - 492  
\_\_\_\_\_ lode mining claim has been located  
by Freeport Minerals Corporation whose current mailing  
address is P.O. Box 1019  
Safford, Arizona 85548

RECEIVED  
BLM AZ STATE OFFICE  
2015 MAY -6 A 9:14  
PHOENIX, ARIZONA  
BLM  
Date  
Stamp

The general course of this claim is North to South and it is situated in Graham  
County, Arizona. This claim is 1450 feet in length and 475 feet in width.

15.8 Total Claim Acreage. This claim runs from the location monument on which this location notice  
is posted on the centerline of the claim approximately 10 feet in a Southerly direction to the South  
end line and 1440 feet in a Northerly direction to the North end line. This claim is marked by six  
monuments, one at each corner and one at the center of each end line of the claim.

The location monument on which this notice is posted is situated within Section 25 Township 5  
S, Range 26 E, Gila Salt River Base and Meridian, Arizona and this claim encompasses portions  
of the following quarter section(s), section(s), Township(s) and Range(s) NE 1/4

Section 25 Township 5S Range 26E SE 1/4 Section 24 Township 5S Range 26E  
Gila Salt River Base and Meridian, Arizona.

The locality of this claim with reference to some natural object or permanent monument and additional information  
(if any) concerning its locality are as follows: The Northeast corner of the claim is 392' North and 375' West of the monument at the  
Northeast Corner of Section 25, Township 5S, Range 26E

The above information is shown on the attached map.

DATED AND POSTED on the ground this 17 day of April, 2015.

LOCATOR(s)  AGENT

Print Name(s) Entellus, Inc. - Daniel G. Francetic, RLS

Signature(s) *Daniel G. Francetic*

Form MCF100  
Revised July 2014

AMC4321811

# RED BULL - 492 CLAIM

LOCATION OF RED BULL-485 THROUGH RED BULL-492 LODE CLAIMS  
 LOCATED IN SECTIONS 24, 25, 36, T.5S., R.26E. AND  
 SECTIONS 19, & 30, 31, T.5S., R.27E.  
 GRAHAM COUNTY, ARIZONA

ALL CLAIMS ARE 1450' IN LENGTH AND  
 600' IN WIDTH UNLESS NOTED

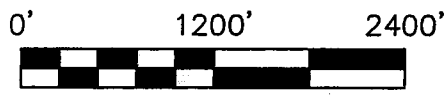
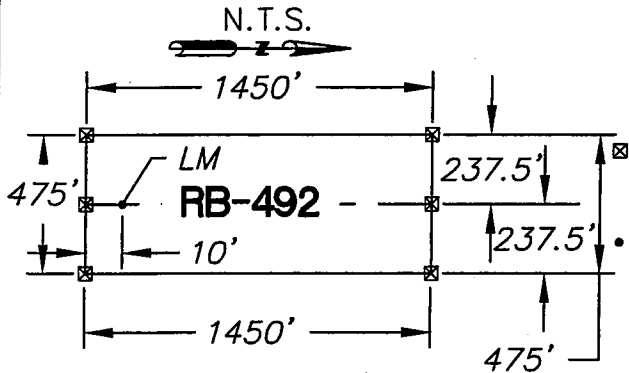
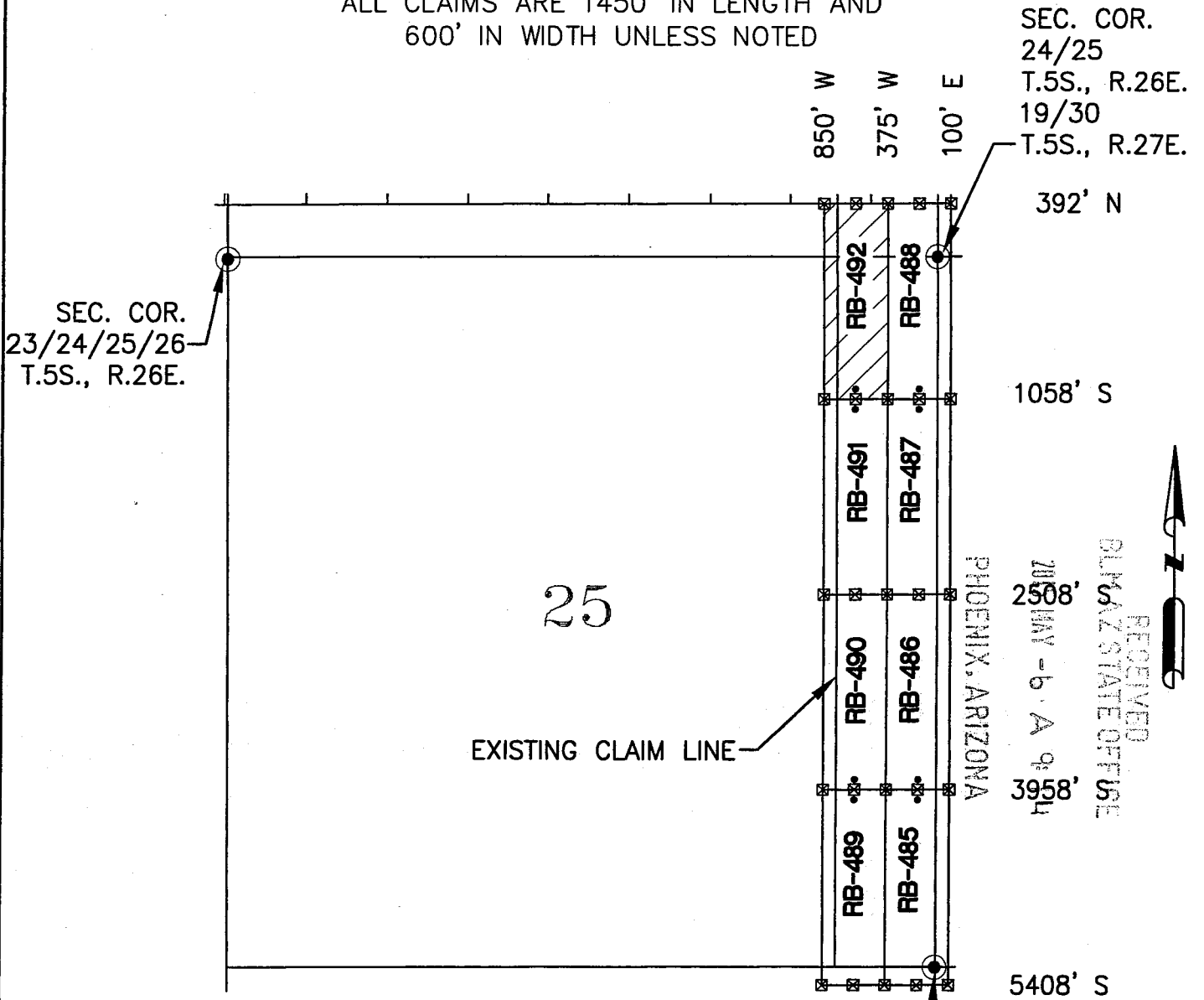

INDICATES CORNER OF LODE CLAIM.  
 SET 2"x2"x5' WOODEN POST (TYPICAL)

INDICATES LOCATION  
 MONUMENT. SET 2"x2"x5'  
 WOODEN POST WITH SIGN  
 (TYPICAL)

LOCATORS:  
 FREEPORT MINERALS CORP.  
 PO BOX 1019  
 SAFFORD AZ 85548

CLAIM ACREAGE = 15.8 AC  
 WC = WITNESS CORNER NORTH  
 OF SIDE LINE

**Entellus™**  
 2255 N. 44th Street Suite 125  
 Phoenix, AZ 85008.3279  
 Tel 602.244.2566  
 Fax 602.244.8947  
 Website: www.Entellus.com

RECEIVED  
 PHOENIX, ARIZONA  
 MAY - 6 A 9:54  
 2008

**LOCATION NOTICE FOR LODE MINING CLAIM**

Amendment      BLM Serial # \_\_\_\_\_

NOTICE IS HEREBY GIVEN that the Red Bull - 530

\_\_\_\_\_ lode mining claim has been located

by Freeport Minerals Corporation whose current mailing

address is P.O. Box 1019

Safford, Arizona 85548

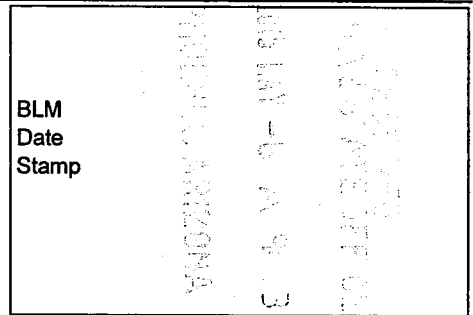

The general course of this claim is North to South and it is situated in Graham

County, Arizona. This claim is 1450 feet in length and 600 feet in width.

20.0 Total Claim Acreage. This claim runs from the location monument on which this location notice

is posted on the centerline of the claim approximately 10 feet in a Southerly direction to the South

end line and 1440 feet in a Northerly direction to the North end line. This claim is marked by six

monuments, one at each corner and one at the center of each end line of the claim.

The location monument on which this notice is posted is situated within Section 13 Township 5

S, Range 26 E, Gila Salt River Base and Meridian, Arizona and this claim encompasses portions

of the following quarter section(s), section(s), Township(s) and Range(s) SE 1/4 NE 1/4

Section 13 Township 5S Range 26E SW 1/4 NW 1/4 Section 18 Township 5S Range 27E

Gila Salt River Base and Meridian, Arizona.

The locality of this claim with reference to some natural object or permanent monument and additional information

(if any) concerning its locality are as follows: The Northeast corner of the claim is 1450' South and 100' East of the monument at the

Northeast Corner of Section 13, Township 5S, Range 26E

The above information is shown on the attached map.

DATED AND POSTED on the ground this 16 day of April, 2015.

LOCATOR(s)       AGENT

Print Name(s) Entellus, Inc. - Daniel G. Francetic, RLS

Signature(s) *Daniel G. Francetic*

Form MCF100  
Revised July 2014

AN0432182



# RED BULL - 530 CLAIM

## LOCATION OF RED BULL-529 THROUGH RED BULL-555 LODE CLAIMS

LOCATED IN SECTIONS 13, & 14, T.5S., R.26E. AND SECTION 18, T.5S., R.27E.  
GRAHAM COUNTY, ARIZONA

ALL CLAIMS ARE 1450' IN LENGTH AND  
600' IN WIDTH UNLESS NOTED

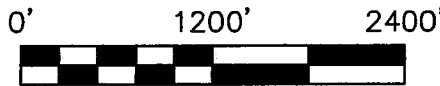
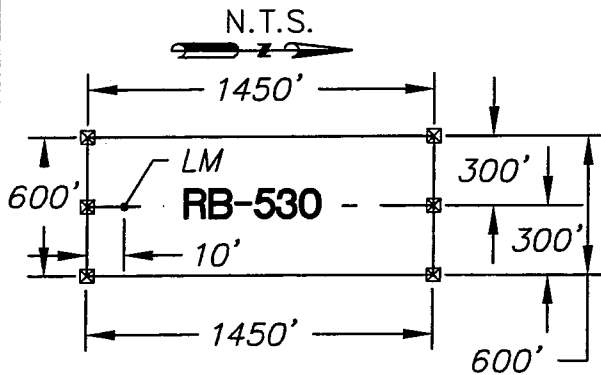
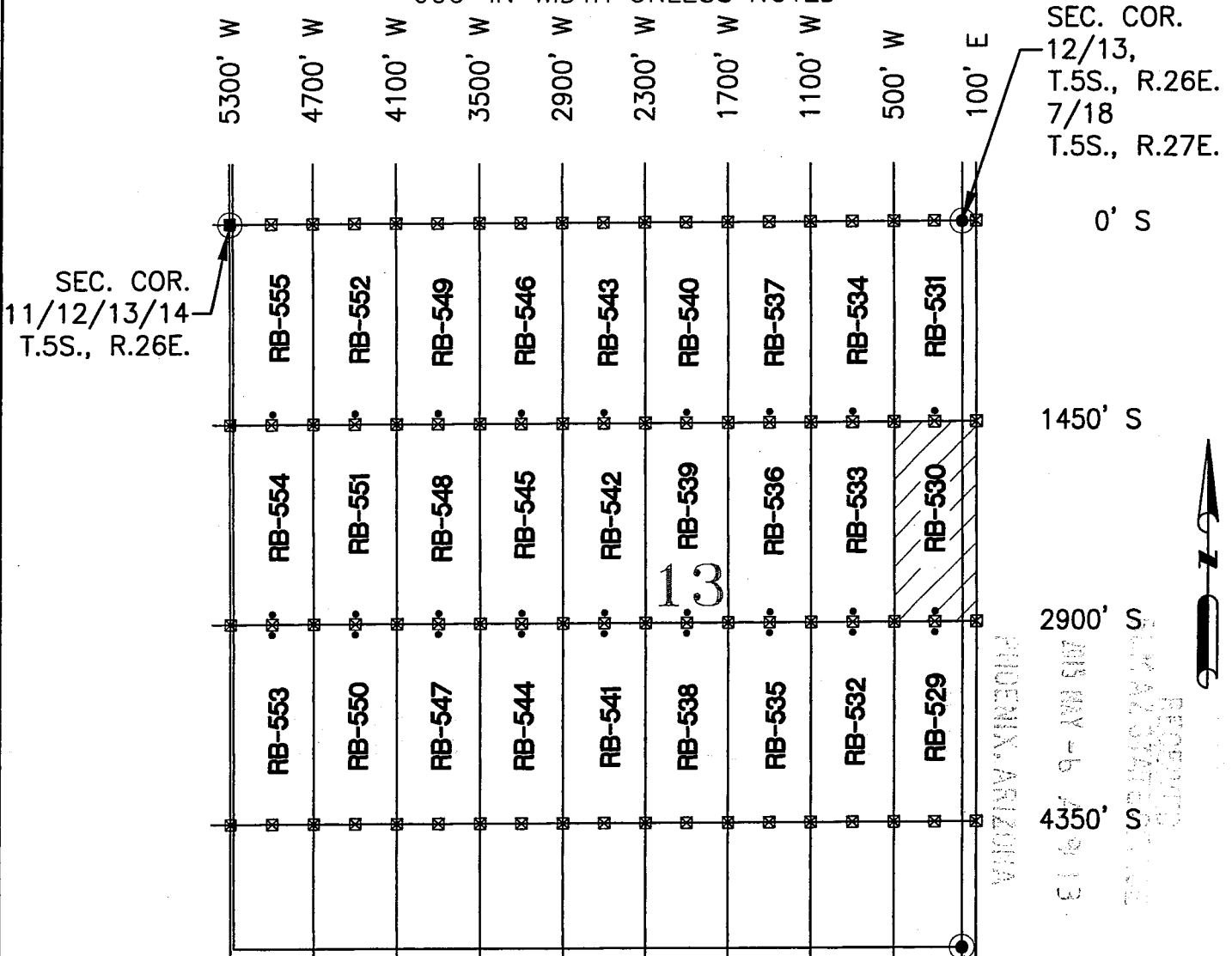

- ☒ INDICATES CORNER OF LODE CLAIM. SET 2"x2"x5' WOODEN POST (TYPICAL)
- INDICATES LOCATION MONUMENT. SET 2"x2"x5' WOODEN POST WITH SIGN (TYPICAL)

LOCATORS:  
FREEPORT MINERALS CORP.  
PO BOX 1019  
SAFFORD AZ 85548

CLAIM ACREAGE = 20.0 AC  
WC = WITNESS CORNER NORTH  
OF SIDE LINE

**Entellus™**  
2255 N. 44th Street Suite 125  
Phoenix, AZ 85008.3279  
Tel 602.244.2566  
Fax 602.244.8947  
Website: www.Entellus.com

AMC4321821

**LOCATION NOTICE FOR LODE MINING CLAIM**

Amendment      BLM Serial # \_\_\_\_\_

NOTICE IS HEREBY GIVEN that the Red Bull - 531

\_\_\_\_\_ lode mining claim has been located

by Freeport Minerals Corporation whose current mailing

address is P.O. Box 1019

Safford, Arizona 85548

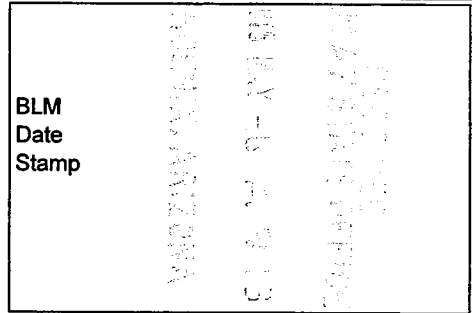

The general course of this claim is North to South and it is situated in Graham

County, Arizona. This claim is 1450 feet in length and 600 feet in width.

20.0 Total Claim Acreage. This claim runs from the location monument on which this location notice

is posted on the centerline of the claim approximately 10 feet in a Southerly direction to the South

end line and 1440 feet in a Northerly direction to the North end line. This claim is marked by six

monuments, one at each corner and one at the center of each end line of the claim.

The location monument on which this notice is posted is situated within Section 13 Township 5

S, Range 26 E, Gila Salt River Base and Meridian, Arizona and this claim encompasses portions

of the following quarter section(s), section(s), Township(s) and Range(s) NE 1/4

Section 13 Township 5S Range 26E NW 1/4 Section 18 Township 5S Range 27E

Gila Salt River Base and Meridian, Arizona.

The locality of this claim with reference to some natural object or permanent monument and additional information

(if any) concerning its locality are as follows: The Northeast corner of the claim is 100' East of the monument at the

Northeast Corner of Section 13, Township 5S, Range 26E on the section line

The above information is shown on the attached map.

DATED AND POSTED on the ground this 16 day of April, 2015.

LOCATOR(s)       AGENT

Print Name(s) Entellus, Inc. - Daniel G. Francetic, RLS

Signature(s) *Daniel G. Francetic*

Form MCF100  
Revised July 2014

AN 432183

# RED BULL - 531 CLAIM

## LOCATION OF RED BULL-529 THROUGH RED BULL-555 LODE CLAIMS

LOCATED IN SECTIONS 13, & 14, T.5S., R.26E. AND SECTION 18, T.5S., R.27E.

GRAHAM COUNTY, ARIZONA

ALL CLAIMS ARE 1450' IN LENGTH AND  
600' IN WIDTH UNLESS NOTED

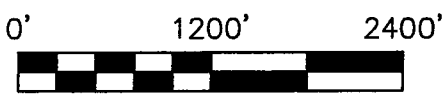
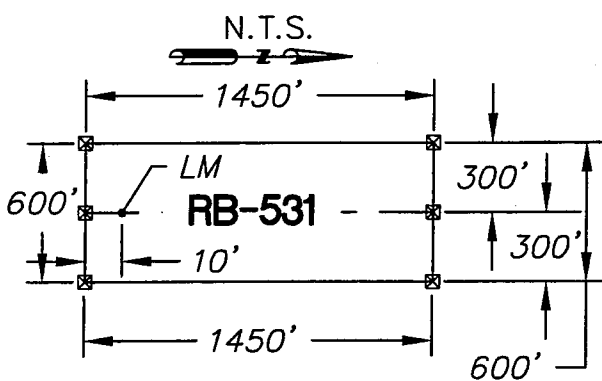
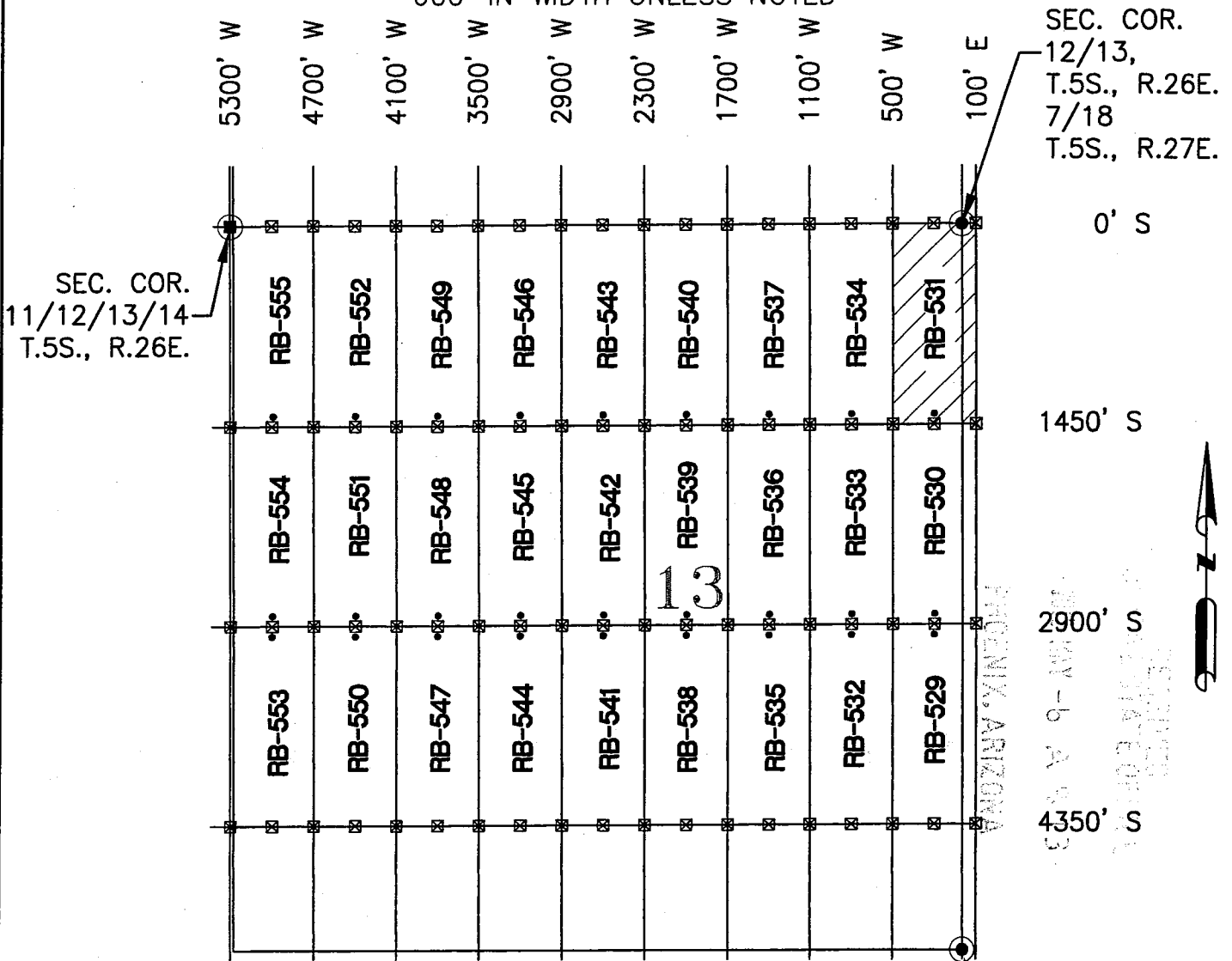

- ☒ INDICATES CORNER OF LODE CLAIM. SET 2"x2"x5' WOODEN POST (TYPICAL)
- INDICATES LOCATION MONUMENT. SET 2"x2"x5' WOODEN POST WITH SIGN (TYPICAL)

LOCATORS:  
FREEPORT MINERALS CORP.  
PO BOX 1019  
SAFFORD AZ 85548

CLAIM ACREAGE = 20.0 AC  
WC = WITNESS CORNER NORTH  
OF SIDE LINE

**Entellus™**  
2255 N. 44th Street Suite 125  
Phoenix, AZ 85008.3279  
Tel 602.244.2566  
Fax 602.244.8947  
Website: www.Entellus.com

LOCATION NOTICE FOR LODE MINING CLAIM

Amendment BLM Serial # \_\_\_\_\_

NOTICE IS HEREBY GIVEN that the Red Bull - 533

\_\_\_\_\_ lode mining claim has been located

by Freeport Minerals Corporation whose current mailing

address is P.O. Box 1019

Safford, Arizona 85548

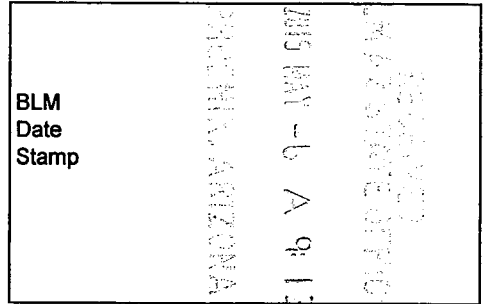

The general course of this claim is North to South and it is situated in Graham

County, Arizona. This claim is 1450 feet in length and 600 feet in width.

20.0 Total Claim Acreage. This claim runs from the location monument on which this location notice

is posted on the centerline of the claim approximately 10 feet in a Southerly direction to the South

end line and 1440 feet in a Northerly direction to the North end line. This claim is marked by six

monuments, one at each corner and one at the center of each end line of the claim.

The location monument on which this notice is posted is situated within Section 13 Township 5

S, Range 26 E, Gila Salt River Base and Meridian, Arizona and this claim encompasses portions

of the following quarter section(s), section(s), Township(s) and Range(s) SE 1/4 NE 1/4

Section 13 Township 5S Range 26E

Gila Salt River Base and Meridian, Arizona.

The locality of this claim with reference to some natural object or permanent monument and additional information

(if any) concerning its locality are as follows: The Northeast corner of the claim is 1450' South and 500' West of the monument at the

Northeast Corner of Section 13, Township 5S, Range 26E

The above information is shown on the attached map.

DATED AND POSTED on the ground this 16 day of April, 2015.

LOCATOR(s)  AGENT

Print Name(s) Entellus, Inc. - Daniel G. Francetic, RLS

Signature(s) *Daniel G. Francetic*

Form MCF100  
Revised July 2014

This form is available from the Arizona Geological Survey and may be reproduced.

AMC432184

# RED BULL - 533 CLAIM

## LOCATION OF RED BULL-529 THROUGH RED BULL-555 LODE CLAIMS

LOCATED IN SECTIONS 13, & 14, T.5S., R.26E. AND SECTION 18, T.5S., R.27E.

GRAHAM COUNTY, ARIZONA

ALL CLAIMS ARE 1450' IN LENGTH AND  
600' IN WIDTH UNLESS NOTED

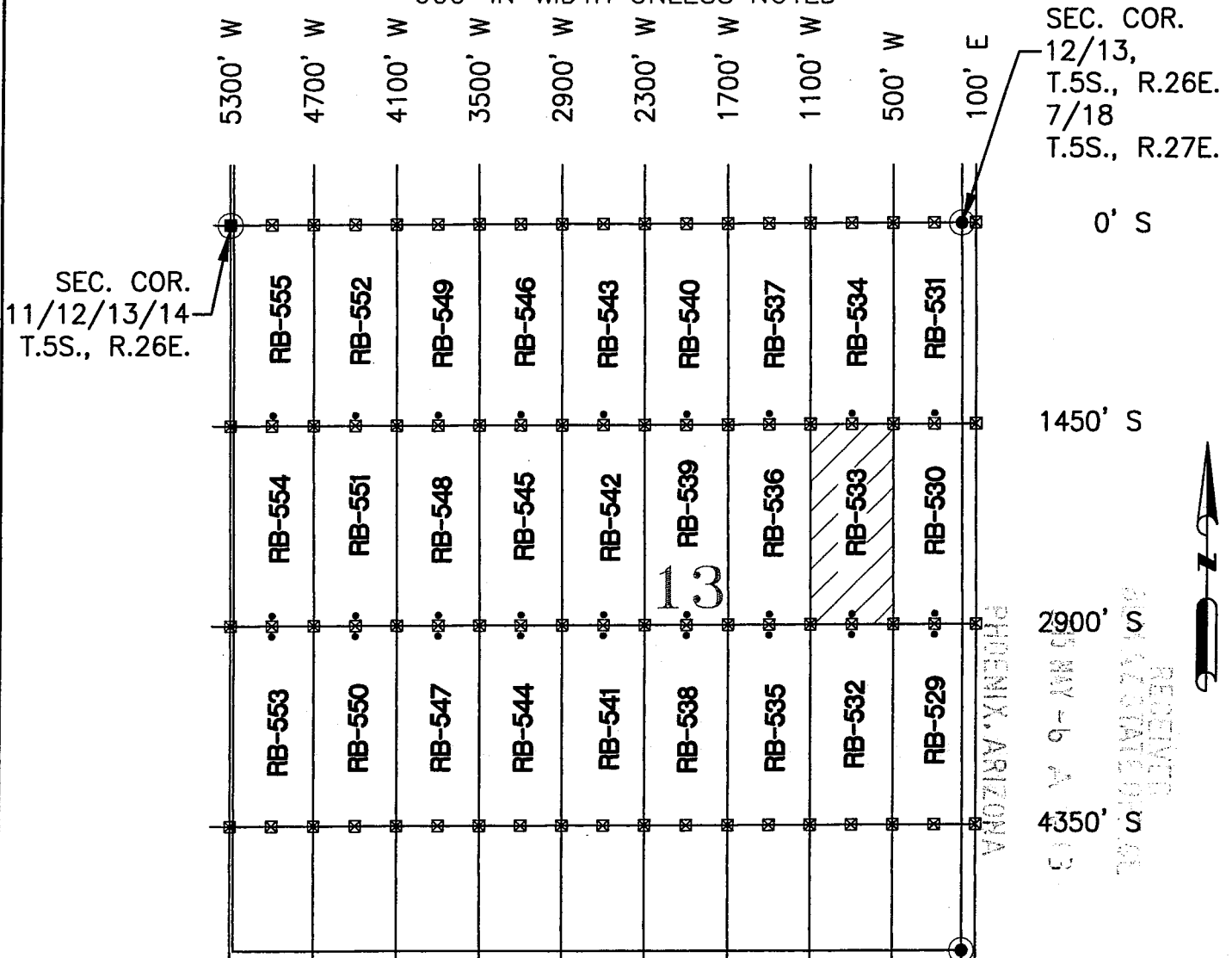

SEC. COR.  
11/12/13/14  
T.5S., R.26E.

SEC. COR.  
12/13,  
T.5S., R.26E.  
7/18  
T.5S., R.27E.

PHOENIX, ARIZONA

RECEIVED  
MAY 9 1994  
COUNTY CLERK  
GRAHAM COUNTY, ARIZONA

SEC. COR.  
13/24.  
T.5S., R.26E.  
18/19  
T.5S., R.27E.

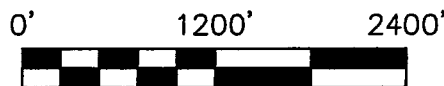
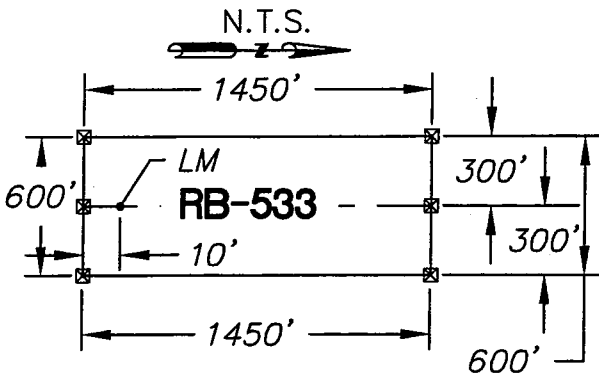

- ☒ INDICATES CORNER OF LODE CLAIM.  
SET 2"x2"x5' WOODEN POST (TYPICAL)
- INDICATES LOCATION  
MONUMENT. SET 2"x2"x5'  
WOODEN POST WITH SIGN  
(TYPICAL)

LOCATORS:  
FREEPORT MINERALS CORP.  
PO BOX 1019  
SAFFORD AZ 85548

CLAIM ACREAGE = 20.0 AC  
WC = WITNESS CORNER NORTH  
OF SIDE LINE

**Entellus™**  
2255 N. 44th Street Suite 125  
Phoenix, AZ 85008.3279  
Tel 602.244.2566  
Fax 602.244.8947  
Website: www.Entellus.com

LOCATION NOTICE FOR LODE MINING CLAIM

Amendment BLM Serial # \_\_\_\_\_

NOTICE IS HEREBY GIVEN that the Red Bull - 534

\_\_\_\_\_ lode mining claim has been located

by Freeport Minerals Corporation whose current mailing

address is P.O. Box 1019

Safford, Arizona 85548

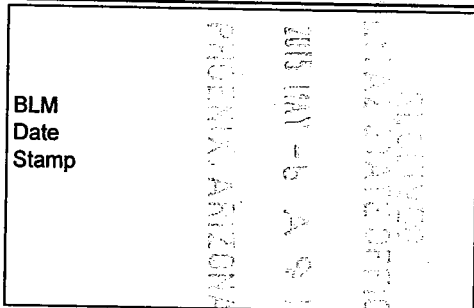

The general course of this claim is North to South and it is situated in Graham

County, Arizona. This claim is 1450 feet in length and 600 feet in width.

20.0 Total Claim Acreage. This claim runs from the location monument on which this location notice is posted on the centerline of the claim approximately 10 feet in a Southerly direction to the South end line and 1440 feet in a Northerly direction to the North end line. This claim is marked by six monuments, one at each corner and one at the center of each end line of the claim.

The location monument on which this notice is posted is situated within Section 13 Township 5 S, Range 26 E, Gila Salt River Base and Meridian, Arizona and this claim encompasses portions

of the following quarter section(s), section(s), Township(s) and Range(s) NE 1/4

Section 13 Township 5S Range 26E

Gila Salt River Base and Meridian, Arizona.

The locality of this claim with reference to some natural object or permanent monument and additional information (if any) concerning its locality are as follows: The Northeast corner of the claim is 500' West of the monument at the Northeast Corner of Section 13, Township 5S, Range 26E on the section line

The above information is shown on the attached map.

DATED AND POSTED on the ground this 16 day of April, 2015.

LOCATOR(s)  AGENT

Print Name(s) Entellus, Inc. - Daniel G. Francetic, RLS

Signature(s) *Daniel G. Francetic*

Form MCF100 Revised July 2014

This form is available from the Arizona Geological Survey and may be reproduced.

AMC432185

# RED BULL - 534 CLAIM

## LOCATION OF RED BULL-529 THROUGH RED BULL-555 LODE CLAIMS

LOCATED IN SECTIONS 13, & 14, T.5S., R.26E. AND SECTION 18, T.5S., R.27E.

GRAHAM COUNTY, ARIZONA

ALL CLAIMS ARE 1450' IN LENGTH AND 600' IN WIDTH UNLESS NOTED

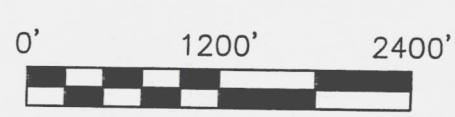
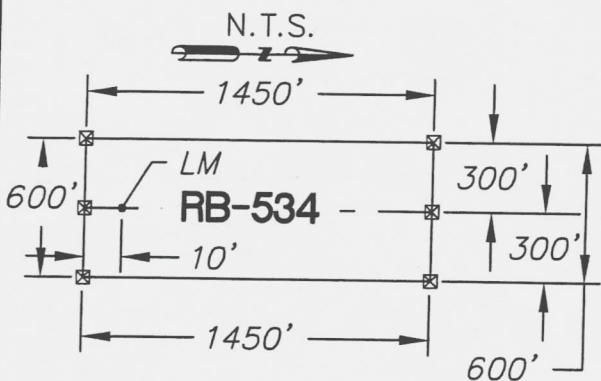
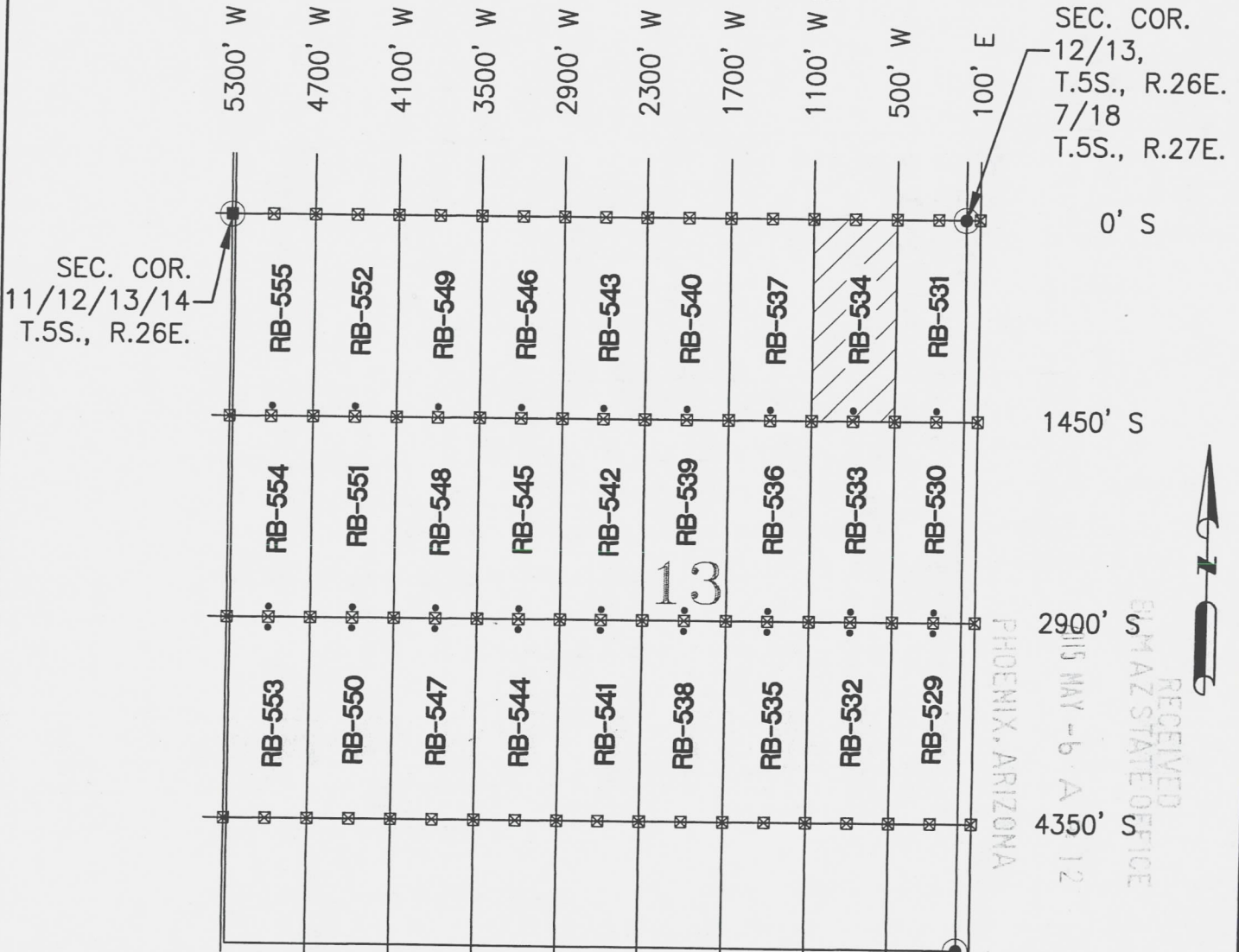

- ☒ INDICATES CORNER OF LODE CLAIM. SET 2"x2"x5' WOODEN POST (TYPICAL)
- INDICATES LOCATION MONUMENT. SET 2"x2"x5' WOODEN POST WITH SIGN (TYPICAL)

LOCATORS:  
 FREEPORT MINERALS CORP.  
 PO BOX 1019  
 SAFFORD AZ 85548

CLAIM ACREAGE = 20.0 AC  
 WC = WITNESS CORNER NORTH  
 OF SIDE LINE

**Entellus™**  
 2255 N. 44th Street Suite 125  
 Phoenix, AZ 85008.3279  
 Tel 602.244.2566  
 Fax 602.244.8947  
 Website: www.Entellus.com

LOCATION NOTICE FOR LODE MINING CLAIM

Amendment BLM Serial # \_\_\_\_\_

NOTICE IS HEREBY GIVEN that the Red Bull - 536

\_\_\_\_\_ lode mining claim has been located

by Freeport Minerals Corporation whose current mailing

address is P.O. Box 1019

Safford, Arizona 85548

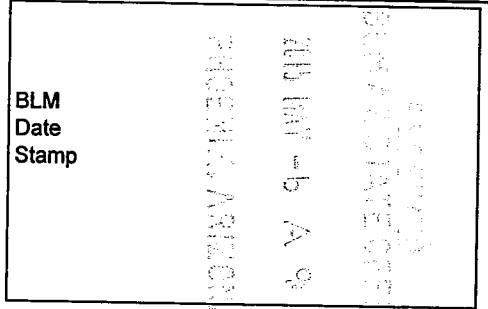

The general course of this claim is North to South and it is situated in Graham

County, Arizona. This claim is 1450 feet in length and 600 feet in width.

20.0 Total Claim Acreage. This claim runs from the location monument on which this location notice

is posted on the centerline of the claim approximately 10 feet in a Southerly direction to the South

end line and 1440 feet in a Northerly direction to the North end line. This claim is marked by six

monuments, one at each corner and one at the center of each end line of the claim.

The location monument on which this notice is posted is situated within Section 13 Township 5

S, Range 26 E, Gila Salt River Base and Meridian, Arizona and this claim encompasses portions

of the following quarter section(s), section(s), Township(s) and Range(s) SE 1/4 NE 1/4

Section 13 Township 5S Range 26E

Gila Salt River Base and Meridian, Arizona.

The locality of this claim with reference to some natural object or permanent monument and additional information

(if any) concerning its locality are as follows: The Northeast corner of the claim is 1450' South and 1100' West of the monument at the

Northeast Corner of Section 13, Township 5S, Range 26E

The above information is shown on the attached map.

DATED AND POSTED on the ground this 16 day of April, 2015.

LOCATOR(s)  AGENT

Print Name(s) Entellus, Inc. - Daniel G. Francetic, RLS

Signature(s) *Daniel G. Francetic*

Form MCF100 Revised July 2014

This form is available from the Arizona Geological Survey and may be reproduced.

AMC 432186



# RED BULL - 536 CLAIM

## LOCATION OF RED BULL-529 THROUGH RED BULL-555 LODE CLAIMS

LOCATED IN SECTIONS 13, & 14, T.5S., R.26E. AND SECTION 18, T.5S., R.27E.

GRAHAM COUNTY, ARIZONA

ALL CLAIMS ARE 1450' IN LENGTH AND 600' IN WIDTH UNLESS NOTED

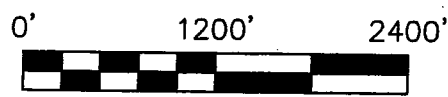
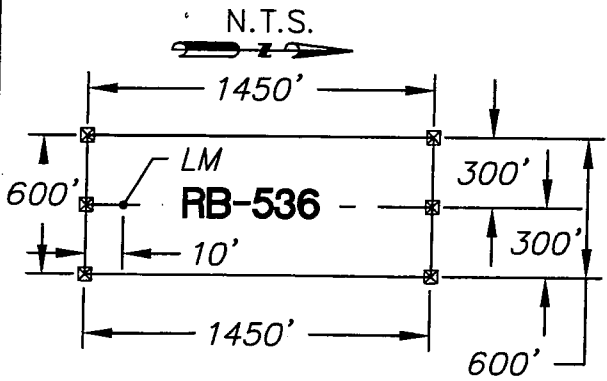
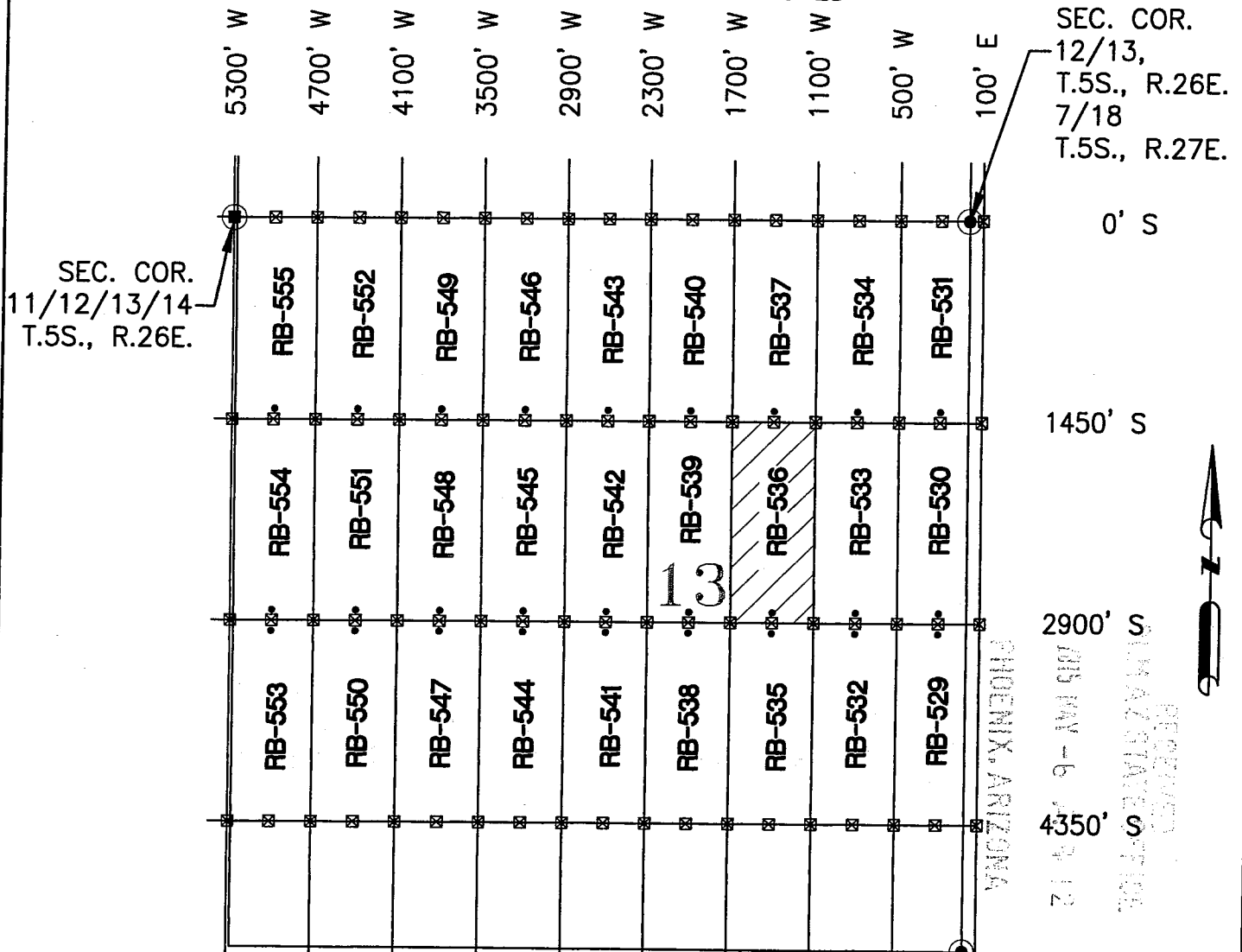

- ☒ INDICATES CORNER OF LODE CLAIM. SET 2"x2"x5' WOODEN POST (TYPICAL)
- INDICATES LOCATION MONUMENT. SET 2"x2"x5' WOODEN POST WITH SIGN (TYPICAL)

LOCATORS:  
 FREEPORT MINERALS CORP.  
 PO BOX 1019  
 SAFFORD AZ 85548

CLAIM ACREAGE = 20.0 AC  
 WC = WITNESS CORNER NORTH OF SIDE LINE

**Entellus™**  
 2255 N. 44th Street Suite 125  
 Phoenix, AZ 85008.3279  
 Tel 602.244.2566  
 Fax 602.244.8947  
 Website: www.Entellus.com

LOCATION NOTICE FOR LODE MINING CLAIM

Amendment BLM Serial # \_\_\_\_\_

NOTICE IS HEREBY GIVEN that the Red Bull - 537

\_\_\_\_\_ lode mining claim has been located

by Freeport Minerals Corporation whose current mailing

address is P.O. Box 1019

Safford, Arizona 85548

The general course of this claim is North to South and it is situated in \_\_\_\_\_

County, Arizona. This claim is 1450 feet in length and 600 feet in width.

20.0 Total Claim Acreage. This claim runs from the location monument on which this location notice

is posted on the centerline of the claim approximately 10 feet in a Southerly direction to the South

end line and 1440 feet in a Northerly direction to the North end line. This claim is marked by six

monuments, one at each corner and one at the center of each end line of the claim.

The location monument on which this notice is posted is situated within Section 13 Township 5

S, Range 26 E, Gila Salt River Base and Meridian, Arizona and this claim encompasses portions

of the following quarter section(s), section(s), Township(s) and Range(s) NE 1/4

Section 13 Township 5S Range 26E

Gila Salt River Base and Meridian, Arizona.

The locality of this claim with reference to some natural object or permanent monument and additional information

(if any) concerning its locality are as follows: The Northeast corner of the claim is 1100' West of the monument at the

Northeast Corner of Section 13, Township 5S, Range 26E on the section line

The above information is shown on the attached map.

DATED AND POSTED on the ground this 16 day of April, 2015.

LOCATOR(s)  AGENT

Print Name(s) Entellus, Inc. - Daniel G. Francetic, RLS

Signature(s) *Daniel G. Francetic*

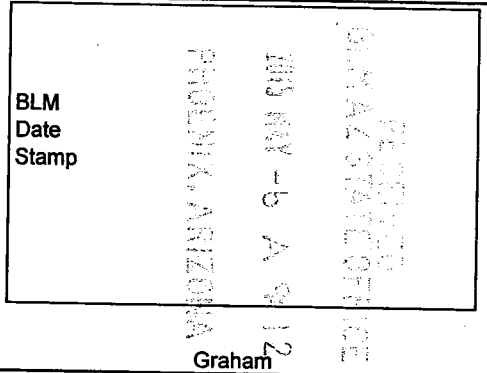

AMC432187

# RED BULL - 537 CLAIM

## LOCATION OF RED BULL-529 THROUGH RED BULL-555 LODE CLAIMS

LOCATED IN SECTIONS 13, & 14, T.5S., R.26E. AND SECTION 18, T.5S., R.27E.

GRAHAM COUNTY, ARIZONA

ALL CLAIMS ARE 1450' IN LENGTH AND  
600' IN WIDTH UNLESS NOTED

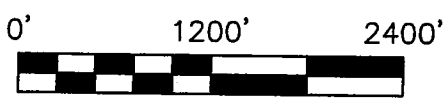
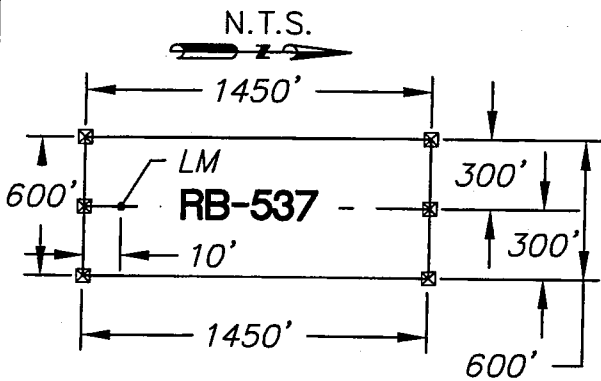
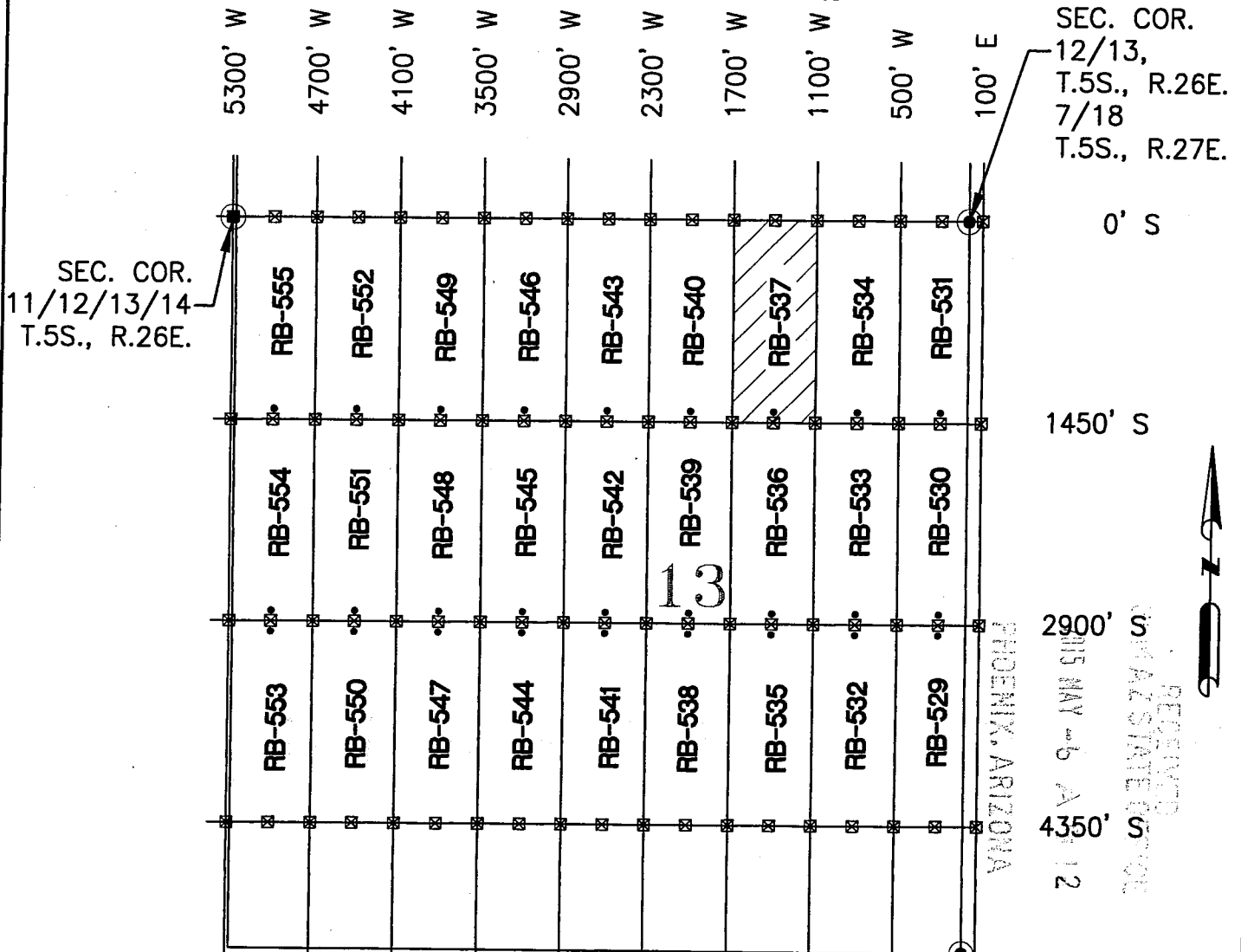

- ☒ INDICATES CORNER OF LODE CLAIM. SET 2"x2"x5' WOODEN POST (TYPICAL)
- INDICATES LOCATION MONUMENT. SET 2"x2"x5' WOODEN POST WITH SIGN (TYPICAL)

LOCATORS:  
FREEPORT MINERALS CORP.  
PO BOX 1019  
SAFFORD AZ 85548

CLAIM ACREAGE = 20.0 AC  
WC = WITNESS CORNER NORTH  
OF SIDE LINE

**Entellus™**  
2255 N. 44th Street Suite 125  
Phoenix, AZ 85008.3279  
Tel 602.244.2566  
Fax 602.244.8947  
Website: www.Entellus.com

RECEIVED  
 GILBERT STATE COURSE  
 MAY 6 2012  
 PHOENIX, ARIZONA

LOCATION NOTICE FOR LODE MINING CLAIM

Amendment BLM Serial # \_\_\_\_\_

NOTICE IS HEREBY GIVEN that the Red Bull - 539

\_\_\_\_\_ lode mining claim has been located

by Freeport Minerals Corporation whose current mailing

address is P.O. Box 1019

Safford, Arizona 85548

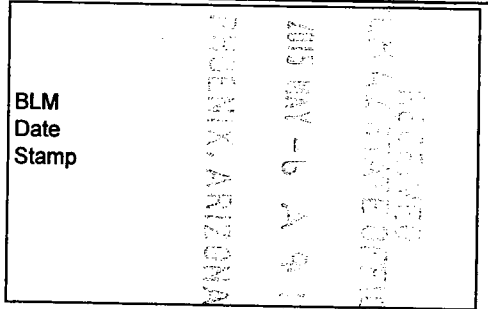

The general course of this claim is North to South and it is situated in Graham

County, Arizona. This claim is 1450 feet in length and 600 feet in width.

20.0 Total Claim Acreage. This claim runs from the location monument on which this location notice

is posted on the centerline of the claim approximately 10 feet in a Southerly direction to the South

end line and 1440 feet in a Northerly direction to the North end line. This claim is marked by six

monuments, one at each corner and one at the center of each end line of the claim.

The location monument on which this notice is posted is situated within Section 13 Township 5

S, Range 26 E, Gila Salt River Base and Meridian, Arizona and this claim encompasses portions

of the following quarter section(s), section(s), Township(s) and Range(s) SE 1/4 NE 1/4

Section 13 Township 5S Range 26E

Gila Salt River Base and Meridian, Arizona.

The locality of this claim with reference to some natural object or permanent monument and additional information

(if any) concerning its locality are as follows: The Northeast corner of the claim is 1450' South and 1700' West of the monument at the

Northeast Corner of Section 13, Township 5S, Range 26E

The above information is shown on the attached map.

DATED AND POSTED on the ground this 16 day of April, 2015.

LOCATOR(s)  AGENT

Print Name(s) Entellus, Inc. - Daniel G. Francetic, RLS

Signature(s) [Handwritten Signature]

Form MCF100 Revised July 2014

This form is available from the Arizona Geological Survey and may be reproduced.

AMC 432188

# RED BULL - 539 CLAIM

## LOCATION OF RED BULL-529 THROUGH RED BULL-555 LODE CLAIMS

LOCATED IN SECTIONS 13, & 14, T.5S., R.26E. AND SECTION 18, T.5S., R.27E.  
GRAHAM COUNTY, ARIZONA

ALL CLAIMS ARE 1450' IN LENGTH AND  
600' IN WIDTH UNLESS NOTED

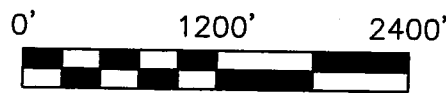
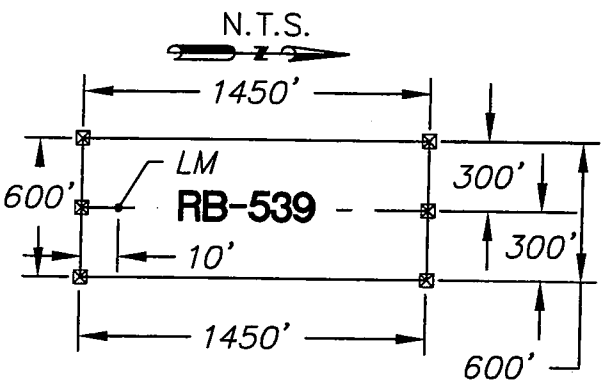
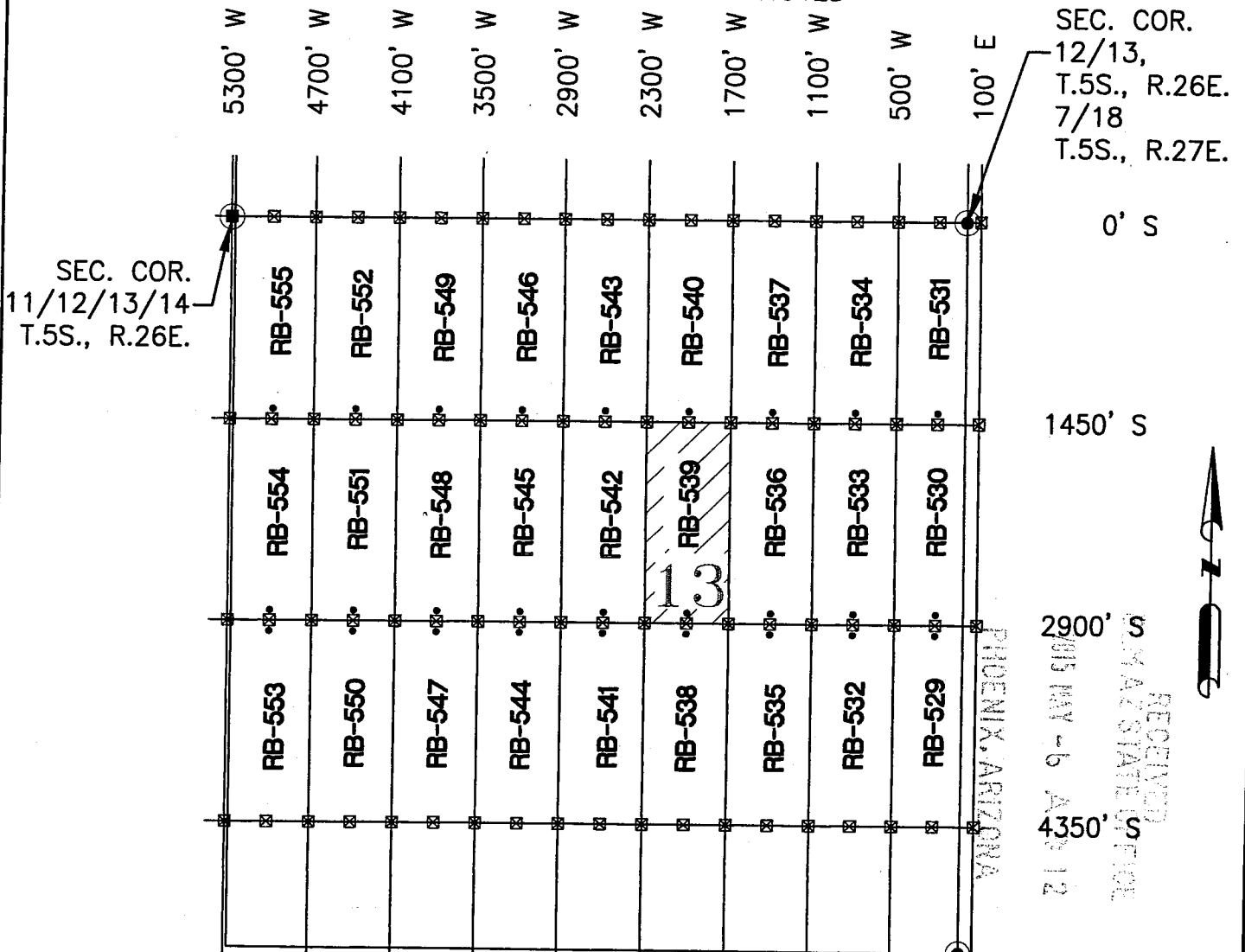

- ☒ INDICATES CORNER OF LODE CLAIM.  
SET 2"x2"x5' WOODEN POST (TYPICAL)
- INDICATES LOCATION  
MONUMENT. SET 2"x2"x5'  
WOODEN POST WITH SIGN  
(TYPICAL)

LOCATORS:  
FREEPORT MINERALS CORP.  
PO BOX 1019  
SAFFORD AZ 85548

CLAIM ACREAGE = 20.0 AC  
WC = WITNESS CORNER NORTH  
OF SIDE LINE

**Entellus™**  
2255 N. 44th Street Suite 125  
Phoenix, AZ 85008.3279  
Tel 602.244.2566  
Fax 602.244.8947  
Website: www.Entellus.com

RECEIVED  
 STATE OFFICE  
 21 MAY 1996  
 12

**LOCATION NOTICE FOR LODE MINING CLAIM**

Amendment      BLM Serial # \_\_\_\_\_

NOTICE IS HEREBY GIVEN that the Red Bull - 540

\_\_\_\_\_ lode mining claim has been located

by Freeport Minerals Corporation whose current mailing

address is P.O. Box 1019

Safford, Arizona 85548

BLM  
Date  
Stamp

ARIZONA  
APR 9 9 12  
SULLY OFFICE

The general course of this claim is North to South and it is situated in Graham

County, Arizona. This claim is 1450 feet in length and 600 feet in width.

20.0 Total Claim Acreage. This claim runs from the location monument on which this location notice is posted on the centerline of the claim approximately 10 feet in a Southerly direction to the South end line and 1440 feet in a Northerly direction to the North end line. This claim is marked by six monuments, one at each corner and one at the center of each end line of the claim.

The location monument on which this notice is posted is situated within Section 13 Township 5

S, Range 26 E, Gila Salt River Base and Meridian, Arizona and this claim encompasses portions

of the following quarter section(s), section(s), Township(s) and Range(s) NE 1/4

Section 13 Township 5S Range 26E

Gila Salt River Base and Meridian, Arizona.

The locality of this claim with reference to some natural object or permanent monument and additional information

(if any) concerning its locality are as follows: The Northeast corner of the claim is 1700' West of the monument at the Northeast Corner of Section 13, Township 5S, Range 26E on the section line

The above information is shown on the attached map.

DATED AND POSTED on the ground this 16 day of April, 2015.

LOCATOR(s)       AGENT

Print Name(s) Entellus, Inc. - Daniel G. Francetic, RLS

Signature(s) *Daniel G. Francetic*

Form MCF100  
Revised July 2014

This form is available from the Arizona Geological Survey and may be reproduced.

AMC432189

# RED BULL - 540 CLAIM

## LOCATION OF RED BULL-529 THROUGH RED BULL-555 LODE CLAIMS

LOCATED IN SECTIONS 13, & 14, T.5S., R.26E. AND SECTION 18, T.5S., R.27E.  
GRAHAM COUNTY, ARIZONA

ALL CLAIMS ARE 1450' IN LENGTH AND  
600' IN WIDTH UNLESS NOTED

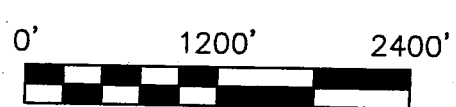
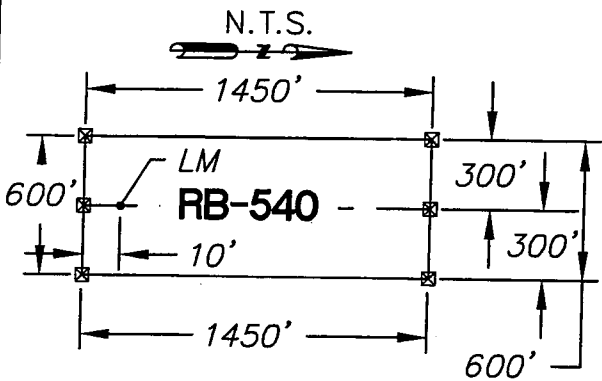
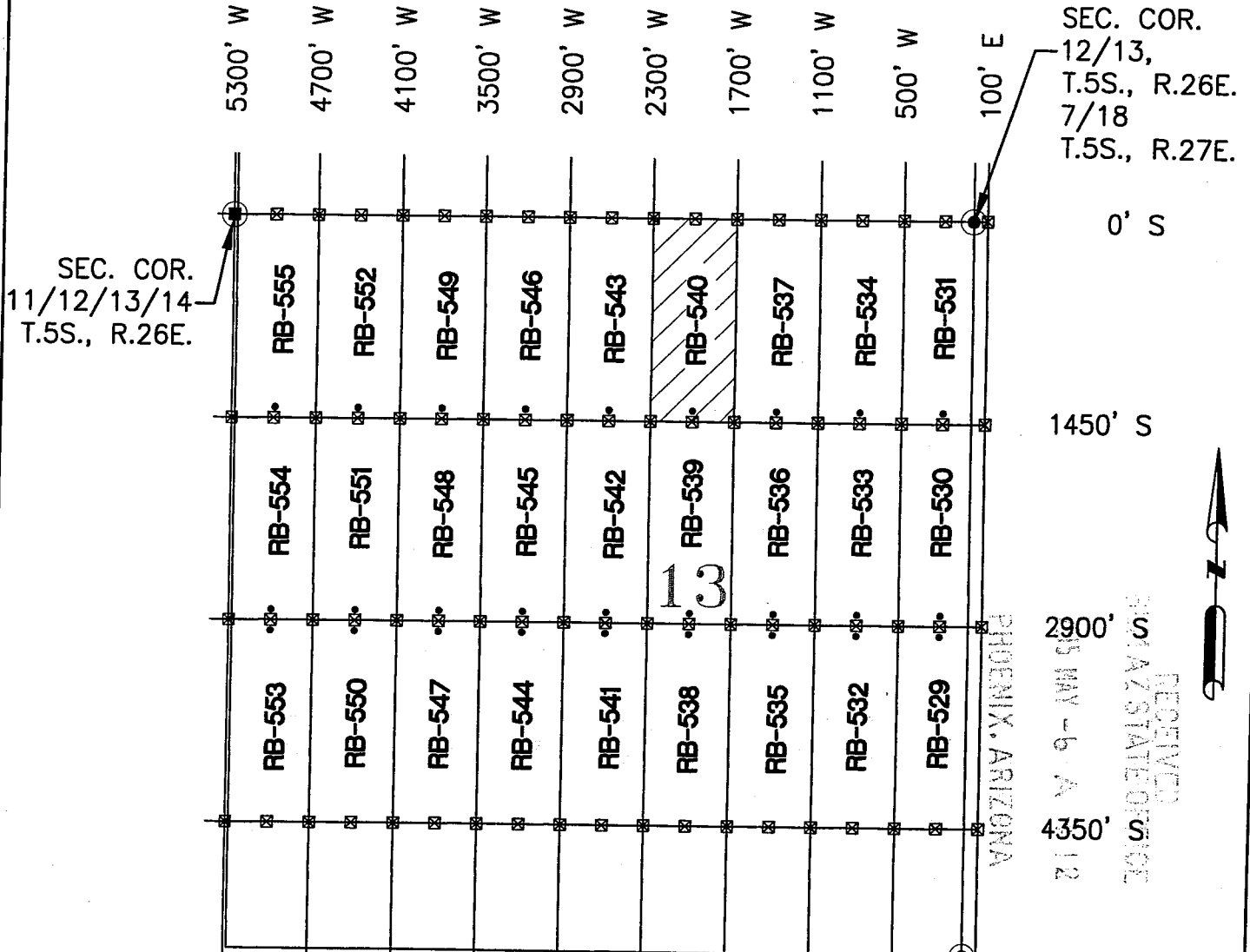

- ☒ INDICATES CORNER OF LODE CLAIM. SET 2"x2"x5' WOODEN POST (TYPICAL)
- INDICATES LOCATION MONUMENT. SET 2"x2"x5' WOODEN POST WITH SIGN (TYPICAL)

LOCATORS:  
FREEPORT MINERALS CORP.  
PO BOX 1019  
SAFFORD AZ 85548

CLAIM ACREAGE = 20.0 AC  
WC = WITNESS CORNER NORTH  
OF SIDE LINE

**Entellus™**  
2255 N. 44th Street Suite 125  
Phoenix, AZ 85008.3279  
Tel 602.244.2566  
Fax 602.244.8947  
Website: www.Entellus.com

RECEIVED  
 ARIZONA STATE OFFICE  
 MAY 6 12

LOCATION NOTICE FOR LODE MINING CLAIM

Amendment BLM Serial # \_\_\_\_\_

NOTICE IS HEREBY GIVEN that the Red Bull - 542

\_\_\_\_\_ lode mining claim has been located

by Freeport Minerals Corporation whose current mailing

address is P.O. Box 1019

Safford, Arizona 85548

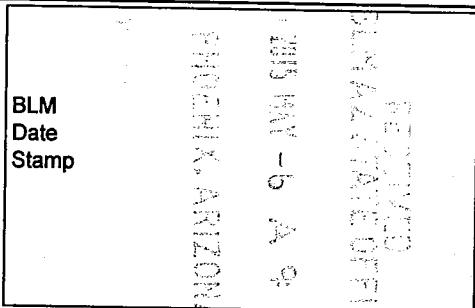

The general course of this claim is North to South and it is situated in Graham

County, Arizona. This claim is 1450 feet in length and 600 feet in width.

20.0 Total Claim Acreage. This claim runs from the location monument on which this location notice is posted on the centerline of the claim approximately 10 feet in a Southerly direction to the South end line and 1440 feet in a Northerly direction to the North end line. This claim is marked by six monuments, one at each corner and one at the center of each end line of the claim.

The location monument on which this notice is posted is situated within Section 13 Township 5 S, Range 26 E, Gila Salt River Base and Meridian, Arizona and this claim encompasses portions of the following quarter section(s), section(s), Township(s) and Range(s) SE 1/4, SW 1/4, NE 1/4, NW 1/4

Section 13 Township 5S Range 26E

Gila Salt River Base and Meridian, Arizona.

The locality of this claim with reference to some natural object or permanent monument and additional information (if any) concerning its locality are as follows: The Northeast corner of the claim is 1450' South and 2300' West of the monument at the Northeast Corner of Section 13, Township 5S, Range 26E

The above information is shown on the attached map.

DATED AND POSTED on the ground this 16 day of April, 2015.

LOCATOR(s)  AGENT

Print Name(s) Entellus, Inc. - Daniel G. Francetic, RLS

Signature(s) [Handwritten Signature]

Form MCF100 Revised July 2014

This form is available from the Arizona Geological Survey and may be reproduced.

AMC432190



# RED BULL - 542 CLAIM

## LOCATION OF BULL-529 THROUGH RED BULL-551 LODE CLAIMS

LOCATED IN SECTIONS 13, & 14, T.5S., R.26E. AND SECTION 18, T.5S., R.27E.

GRAHAM COUNTY, ARIZONA

ALL CLAIMS ARE 1450' IN LENGTH AND  
600' IN WIDTH UNLESS NOTED

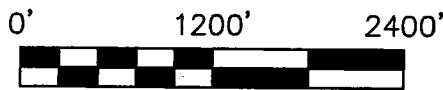
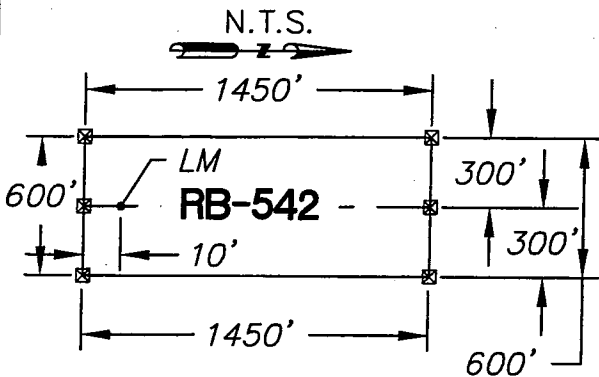
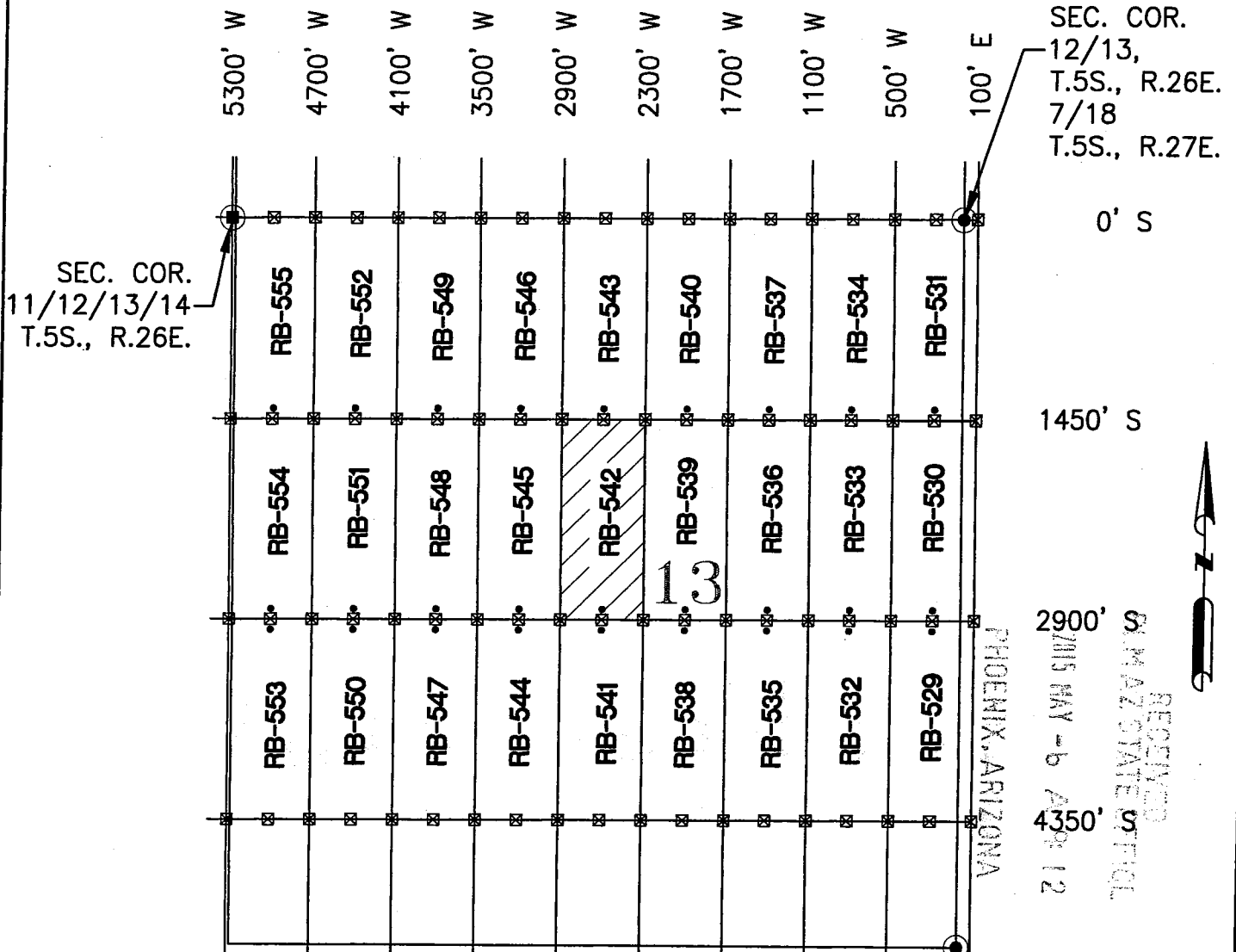

- ☒ INDICATES CORNER OF LODE CLAIM. SET 2"x2"x5' WOODEN POST (TYPICAL)
- INDICATES LOCATION MONUMENT. SET 2"x2"x5' WOODEN POST WITH SIGN (TYPICAL)

LOCATORS:  
FREEPORT MINERALS CORP.  
PO BOX 1019  
SAFFORD AZ 85548

CLAIM ACREAGE = 20.0 AC  
WC = WITNESS CORNER NORTH  
OF SIDE LINE

 **Entellus™**  
2255 N. 44th Street Suite 125  
Phoenix, AZ 85008.3279  
Tel 602.244.2566  
Fax 602.244.8947  
Website: www.Entellus.com

LOCATION NOTICE FOR LODE MINING CLAIM

Amendment BLM Serial # \_\_\_\_\_

NOTICE IS HEREBY GIVEN that the Red Bull - 543

\_\_\_\_\_ lode mining claim has been located

by Freeport Minerals Corporation whose current mailing

address is P.O. Box 1019

Safford, Arizona 85548

The general course of this claim is North to South and it is situated in Graham

County, Arizona. This claim is 1450 feet in length and 600 feet in width.

20.0 Total Claim Acreage. This claim runs from the location monument on which this location notice

is posted on the centerline of the claim approximately 10 feet in a Southerly direction to the South

end line and 1440 feet in a Northerly direction to the North end line. This claim is marked by six

monuments, one at each corner and one at the center of each end line of the claim.

The location monument on which this notice is posted is situated within Section 13 Township 5

S, Range 26 E, Gila Salt River Base and Meridian, Arizona and this claim encompasses portions

of the following quarter section(s), section(s), Township(s) and Range(s) NE 1/4 NW 1/4

Section 13 Township 5S Range 26E

Gila Salt River Base and Meridian, Arizona.

The locality of this claim with reference to some natural object or permanent monument and additional information

(if any) concerning its locality are as follows: The Northeast corner of the claim is 2300' West of the monument at the

Northeast Corner of Section 13, Township 5S, Range 26E on the section line

The above information is shown on the attached map.

DATED AND POSTED on the ground this 16 day of April, 2015.

LOCATOR(s)  AGENT

Print Name(s) Entellus, Inc. - Daniel G. Francetic, RLS

Signature(s) *Daniel G. Francetic*

RECEIVED  
BLM AZ STATE OFFICE  
MAY -6 A 9 12  
PHOENIX, ARIZONA  
BLM  
Date  
Stamp

AMC4321911

# RED BULL - 543 CLAIM

LOCATION OF RED BULL-529 THROUGH RED BULL-555 LODE CLAIMS

LOCATED IN SECTIONS 13, & 14, T.5S., R.26E. AND SECTION 18, T.5S., R.27E.

GRAHAM COUNTY, ARIZONA

ALL CLAIMS ARE 1450' IN LENGTH AND 600' IN WIDTH UNLESS NOTED

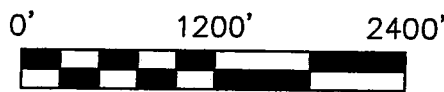
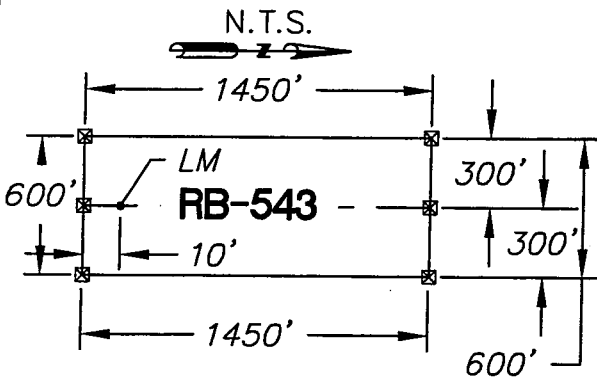
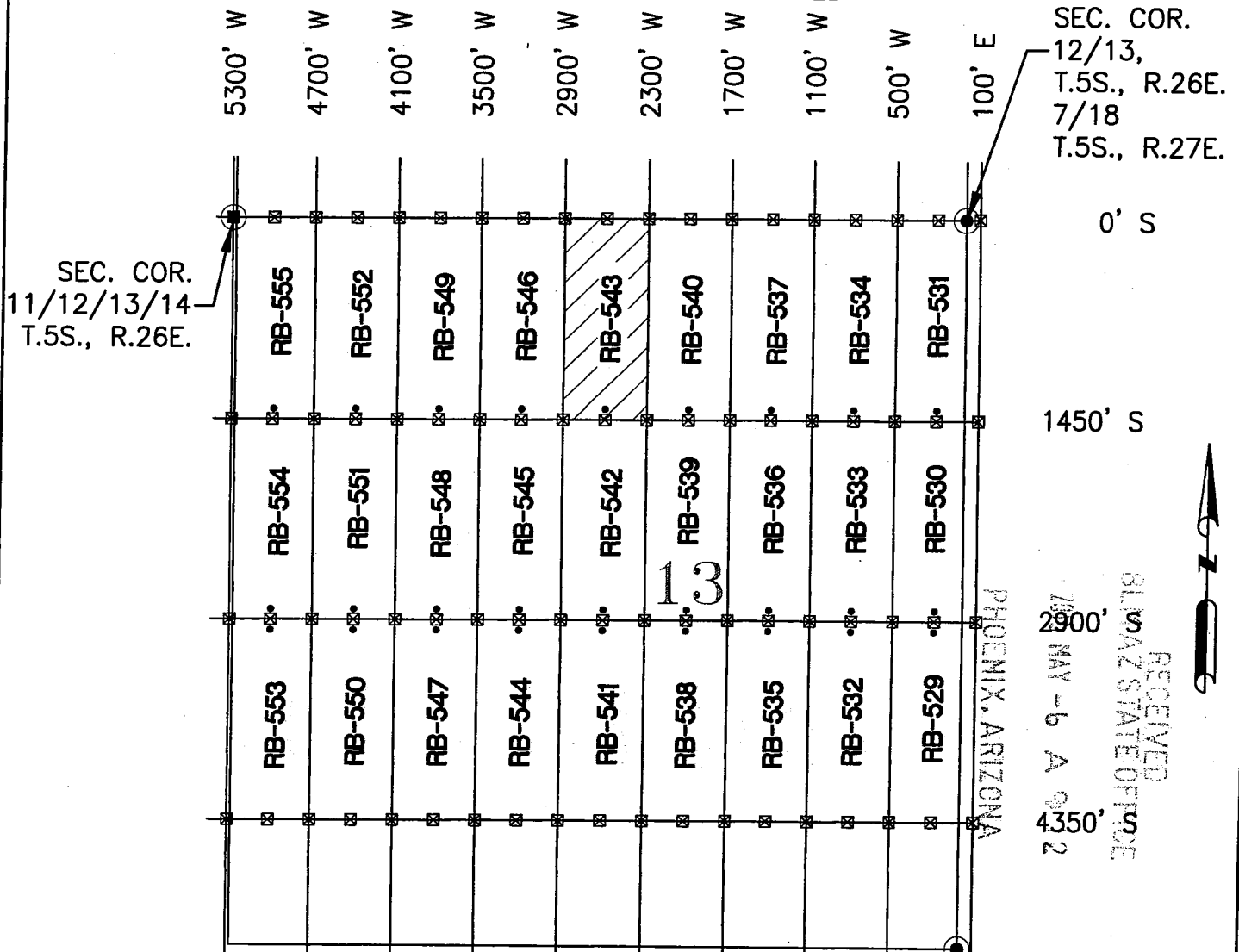

- ☒ INDICATES CORNER OF LODE CLAIM. SET 2"x2"x5' WOODEN POST (TYPICAL)
- INDICATES LOCATION MONUMENT. SET 2"x2"x5' WOODEN POST WITH SIGN (TYPICAL)

LOCATORS:  
 FREEPORT MINERALS CORP.  
 PO BOX 1019  
 SAFFORD AZ 85548

CLAIM ACREAGE = 20.0 AC  
 WC = WITNESS CORNER NORTH  
 OF SIDE LINE

**Entellus™**  
 2255 N. 44th Street Suite 125  
 Phoenix, AZ 85008.3279  
 Tel 602.244.2566  
 Fax 602.244.8947  
 Website: www.Entellus.com

LOCATION NOTICE FOR LODE MINING CLAIM

Amendment BLM Serial # \_\_\_\_\_

NOTICE IS HEREBY GIVEN that the Red Bull - 545

\_\_\_\_\_ lode mining claim has been located

by Freeport Minerals Corporation whose current mailing

address is P.O. Box 1019

Safford, Arizona 85548

BLM  
Date  
Stamp

RECEIVED  
BLM STATE OFFICE  
PHOENIX, ARIZONA  
1015 MAY -6 A 9 12

The general course of this claim is North to South and it is situated in Graham

County, Arizona. This claim is 1450 feet in length and 600 feet in width.

20.0 Total Claim Acreage. This claim runs from the location monument on which this location notice

is posted on the centerline of the claim approximately 10 feet in a Southerly direction to the South

end line and 1440 feet in a Northerly direction to the North end line. This claim is marked by six

monuments, one at each corner and one at the center of each end line of the claim.

The location monument on which this notice is posted is situated within Section 13 Township 5

S, Range 26 E, Gila Salt River Base and Meridian, Arizona and this claim encompasses portions

of the following quarter section(s), section(s), Township(s) and Range(s) SW 1/4 NW 1/4

Section 13 Township 5S Range 26E

Gila Salt River Base and Meridian, Arizona.

The locality of this claim with reference to some natural object or permanent monument and additional information

(if any) concerning its locality are as follows: The Northeast corner of the claim is 1450' South and 2900' West of the monument at the

Northeast Corner of Section 13, Township 5S, Range 26E

The above information is shown on the attached map.

DATED AND POSTED on the ground this 16 day of April, 2015.

LOCATOR(s)  AGENT

Print Name(s) Entellus, Inc. - Daniel G. Francetic, RLS

Signature(s) *Daniel G. Francetic*

Form MCF100  
Revised July 2014

This form is available from the Arizona Geological Survey and may be reproduced.

AMC 4321921

# RED BULL - 545 CLAIM

## LOCATION OF RED BULL-529 THROUGH RED BULL-555 LODE CLAIMS

LOCATED IN SECTIONS 13, & 14, T.5S., R.26E. AND SECTION 18, T.5S., R.27E.

GRAHAM COUNTY, ARIZONA

ALL CLAIMS ARE 1450' IN LENGTH AND 600' IN WIDTH UNLESS NOTED

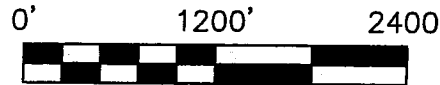
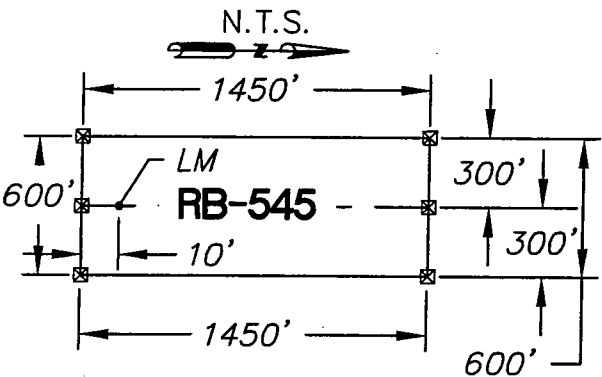
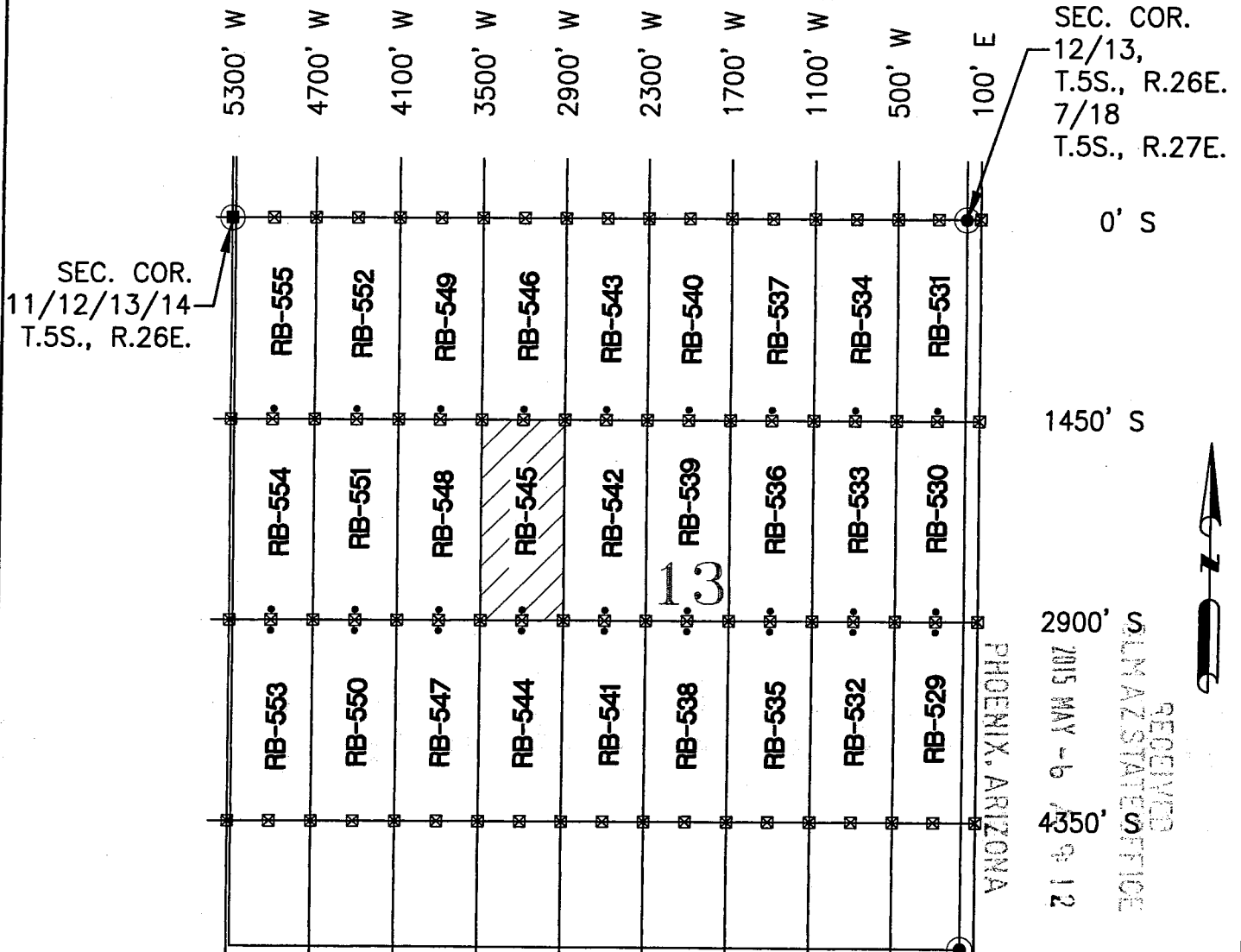

- ☒ INDICATES CORNER OF LODE CLAIM. SET 2"x2"x5' WOODEN POST (TYPICAL)
- INDICATES LOCATION MONUMENT. SET 2"x2"x5' WOODEN POST WITH SIGN (TYPICAL)

LOCATORS:  
 FREEPORT MINERALS CORP.  
 PO BOX 1019  
 SAFFORD AZ 85548

CLAIM ACREAGE = 20.0 AC  
 WC = WITNESS CORNER NORTH  
 OF SIDE LINE

2255 N. 44th Street Suite 125  
 Phoenix, AZ 85008.3279  
 Tel 602.244.2566  
 Fax 602.244.8947  
 Website: www.Entellus.com

RECEIVED  
 CLM AZ STATE OFFICE  
 2015 MAY - 6 9 12

LOCATION NOTICE FOR LODE MINING CLAIM

Amendment BLM Serial # \_\_\_\_\_

NOTICE IS HEREBY GIVEN that the Red Bull - 546  
\_\_\_\_\_ lode mining claim has been located  
by Freeport Minerals Corporation whose current mailing  
address is P.O. Box 1019  
Safford, Arizona 85548

RECEIVED  
BLM AZ STATE OFFICE  
2015 MAY -6 A 9:12  
PHOENIX, ARIZONA  
BLM  
Date  
Stamp

The general course of this claim is North to South and it is situated in Graham  
County, Arizona. This claim is 1450 feet in length and 600 feet in width.

20.0 Total Claim Acreage. This claim runs from the location monument on which this location notice  
is posted on the centerline of the claim approximately 10 feet in a Southerly direction to the South  
end line and 1440 feet in a Northerly direction to the North end line. This claim is marked by six  
monuments, one at each corner and one at the center of each end line of the claim.

The location monument on which this notice is posted is situated within Section 13 Township 5  
S, Range 26 E, Gila Salt River Base and Meridian, Arizona and this claim encompasses portions  
of the following quarter section(s), section(s), Township(s) and Range(s) NW 1/4

Section 13 Township 5S Range 26E

Gila Salt River Base and Meridian, Arizona.

The locality of this claim with reference to some natural object or permanent monument and additional information  
(if any) concerning its locality are as follows: The Northeast corner of the claim is 2900' West of the monument at the  
Northeast Corner of Section 13, Township 5S, Range 26E on the section line

The above information is shown on the attached map.

DATED AND POSTED on the ground this 16 day of April, 2015

LOCATOR(s)  AGENT

Print Name(s) Entellus, Inc. - Daniel G. Francetic, RLS

Signature(s) *Daniel G. Francetic*

Form MCF100  
Revised July 2014

AMC432193

# RED BULL - 546 CLAIM

LOCATION OF RED BULL-529 THROUGH RED BULL-555 LODE CLAIMS  
 LOCATED IN SECTIONS 13, & 14, T.5S., R.26E. AND SECTION 18, T.5S., R.27E.  
 GRAHAM COUNTY, ARIZONA  
 ALL CLAIMS ARE 1450' IN LENGTH AND  
 600' IN WIDTH UNLESS NOTED

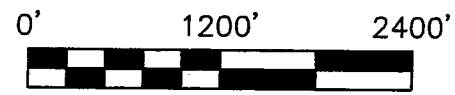
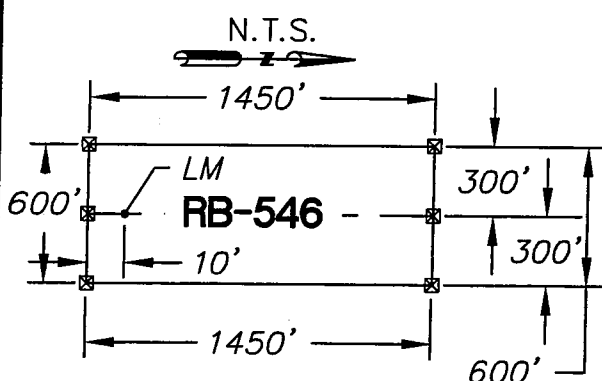
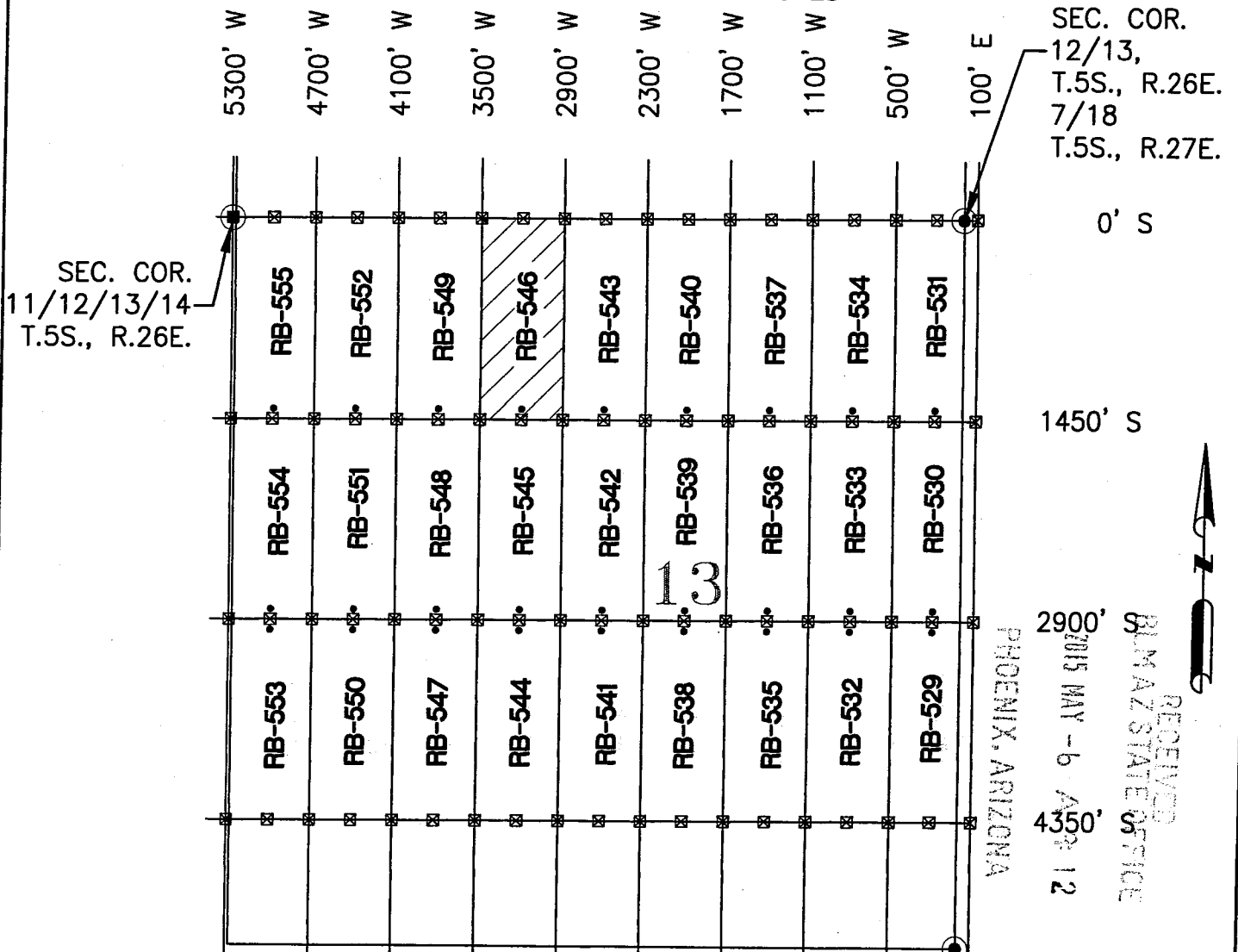

- ⊠ INDICATES CORNER OF LODE CLAIM. SET 2"x2"x5' WOODEN POST (TYPICAL)
- INDICATES LOCATION MONUMENT. SET 2"x2"x5' WOODEN POST WITH SIGN (TYPICAL)

LOCATORS:  
 FREEPORT MINERALS CORP.  
 PO BOX 1019  
 SAFFORD AZ 85548

CLAIM ACREAGE = 20.0 AC  
 WC = WITNESS CORNER NORTH  
 OF SIDE LINE

**Entellus™**  
 2255 N. 44th Street Suite 125  
 Phoenix, AZ 85008.3279  
 Tel 602.244.2566  
 Fax 602.244.8947  
 Website: www.Entellus.com

LOCATION NOTICE FOR LODE MINING CLAIM

Amendment BLM Serial # \_\_\_\_\_

NOTICE IS HEREBY GIVEN that the Red Bull - 548

\_\_\_\_\_ lode mining claim has been located

by Freeport Minerals Corporation whose current mailing

address is P.O. Box 1019

Safford, Arizona 85548

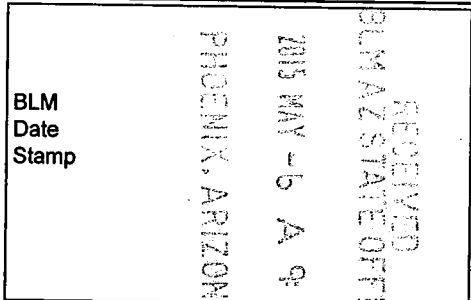

The general course of this claim is North to South and it is situated in Graham

County, Arizona. This claim is 1450 feet in length and 600 feet in width.

20.0 Total Claim Acreage. This claim runs from the location monument on which this location notice

is posted on the centerline of the claim approximately 10 feet in a Southerly direction to the South

end line and 1440 feet in a Northerly direction to the North end line. This claim is marked by six

monuments, one at each corner and one at the center of each end line of the claim.

The location monument on which this notice is posted is situated within Section 13 Township 5

S, Range 26 E, Gila Salt River Base and Meridian, Arizona and this claim encompasses portions

of the following quarter section(s), section(s), Township(s) and Range(s) SW 1/4 NW 1/4

Section 13 Township 5S Range 26E

Gila Salt River Base and Meridian, Arizona.

The locality of this claim with reference to some natural object or permanent monument and additional information

(if any) concerning its locality are as follows: The Northeast corner of the claim is 1450' South and 3500' West of the monument at the

Northeast Corner of Section 13, Township 5S, Range 26E

The above information is shown on the attached map.

DATED AND POSTED on the ground this 16 day of April, 2015.

LOCATOR(s)  AGENT

Print Name(s) Entellus, Inc. - Daniel G. Francetic, RLS

Signature(s) [Signature]

Form MCF100 Revised July 2014

AMC432194



# RED BULL - 548 CLAIM

LOCATION OF RED BULL-529 THROUGH RED BULL-555 LODE CLAIMS  
 LOCATED IN SECTIONS 13, & 14, T.5S., R.26E. AND SECTION 18, T.5S., R.27E.  
 GRAHAM COUNTY, ARIZONA

ALL CLAIMS ARE 1450' IN LENGTH AND  
 600' IN WIDTH UNLESS NOTED

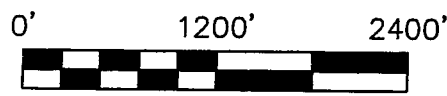
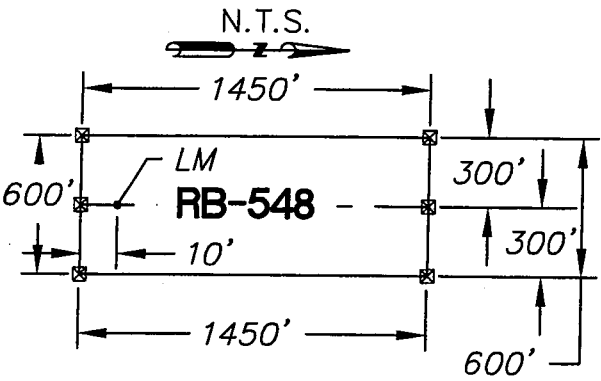
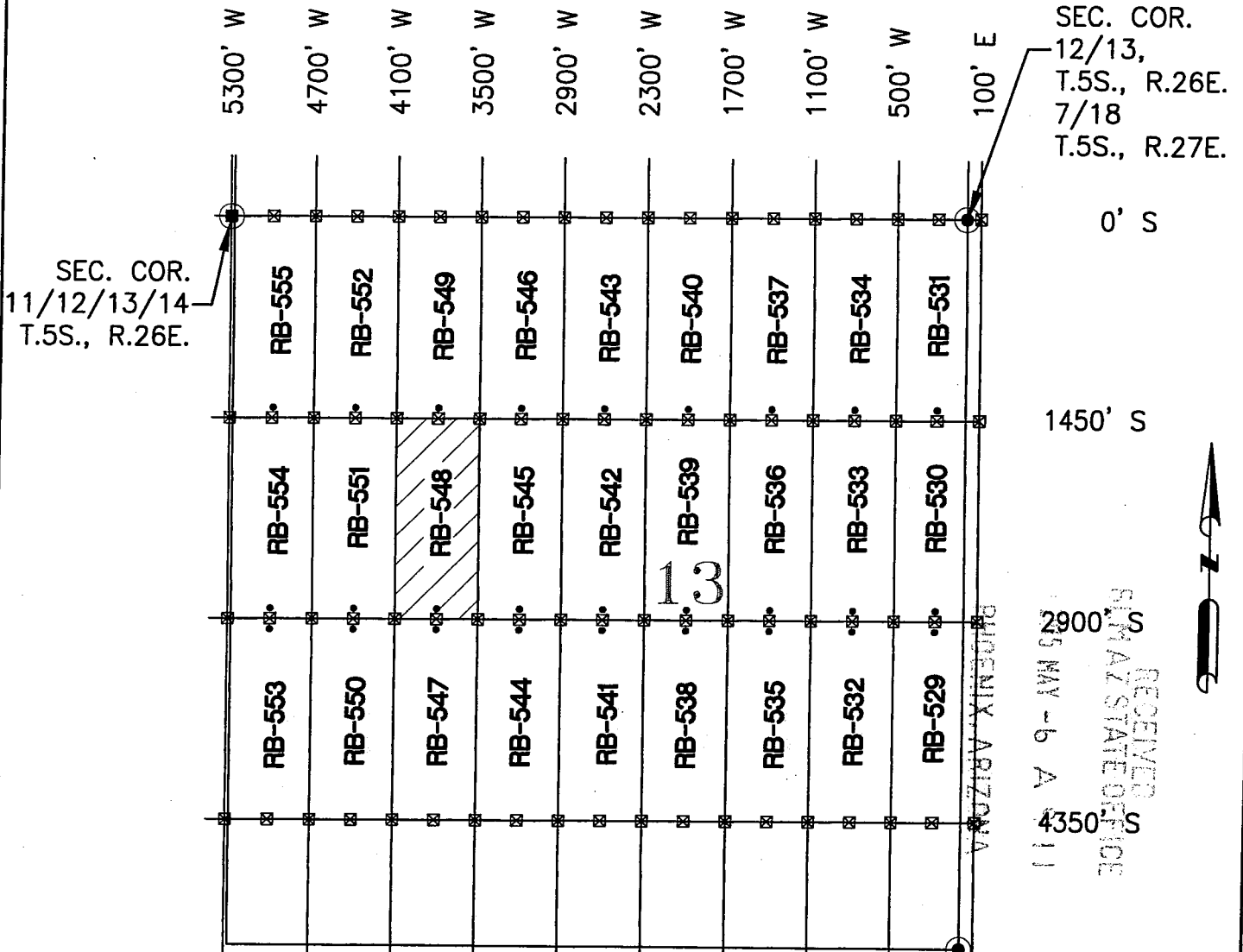

- ☒ INDICATES CORNER OF LODE CLAIM. SET 2"x2"x5' WOODEN POST (TYPICAL)
- INDICATES LOCATION MONUMENT. SET 2"x2"x5' WOODEN POST WITH SIGN (TYPICAL)

LOCATORS:  
 FREEPORT MINERALS CORP.  
 PO BOX 1019  
 SAFFORD AZ 85548

CLAIM ACREAGE = 20.0 AC  
 WC = WITNESS CORNER NORTH  
 OF SIDE LINE

**Entellus™**  
 2255 N. 44th Street Suite 125  
 Phoenix, AZ 85008.3279  
 Tel 602.244.2566  
 Fax 602.244.8947  
 Website: www.Entellus.com

RECEIVED  
 MINERAL STATE OFFICE  
 2900 S  
 45 MAY -6 A  
 4350 S  
 11

LOCATION NOTICE FOR LODE MINING CLAIM

Amendment BLM Serial # \_\_\_\_\_

NOTICE IS HEREBY GIVEN that the Red Bull - 549

\_\_\_\_\_ lode mining claim has been located

by Freeport Minerals Corporation whose current mailing

address is P.O. Box 1019

Safford, Arizona 85548

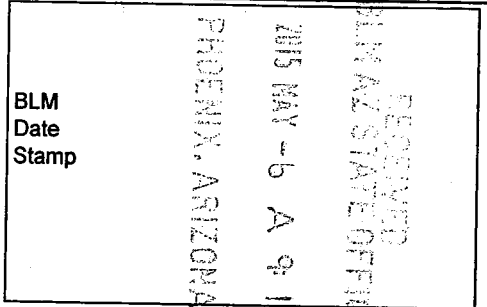

The general course of this claim is North to South and it is situated in Graham

County, Arizona. This claim is 1450 feet in length and 600 feet in width.

20.0 Total Claim Acreage. This claim runs from the location monument on which this location notice

is posted on the centerline of the claim approximately 10 feet in a Southerly direction to the South

end line and 1440 feet in a Northerly direction to the North end line. This claim is marked by six

monuments, one at each corner and one at the center of each end line of the claim.

The location monument on which this notice is posted is situated within Section 13 Township 5

S, Range 26 E, Gila Salt River Base and Meridian, Arizona and this claim encompasses portions

of the following quarter section(s), section(s), Township(s) and Range(s) NW 1/4

Section 13 Township 5S Range 26E

Gila Salt River Base and Meridian, Arizona.

The locality of this claim with reference to some natural object or permanent monument and additional information

(if any) concerning its locality are as follows: The Northeast corner of the claim is 3500' West of the monument at the

Northeast Corner of Section 13, Township 5S, Range 26E on the section line

The above information is shown on the attached map.

DATED AND POSTED on the ground this 16 day of April, 2015.

LOCATOR(s)  AGENT

Print Name(s) Entellus, Inc. - Daniel G. Francetic, RLS

Signature(s) [Handwritten Signature]

Form MCF100 Revised July 2014

This form is available from the Arizona Geological Survey and may be reproduced.

AMC432195

# RED BULL - 549 CLAIM

## LOCATION OF RED BULL-529 THROUGH RED BULL-555 LODE CLAIMS

LOCATED IN SECTIONS 13, & 14, T.5S., R.26E. AND SECTION 18, T.5S., R.27E.

GRAHAM COUNTY, ARIZONA

ALL CLAIMS ARE 1450' IN LENGTH AND 600' IN WIDTH UNLESS NOTED

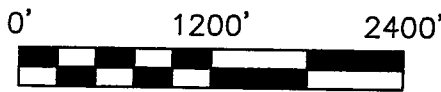
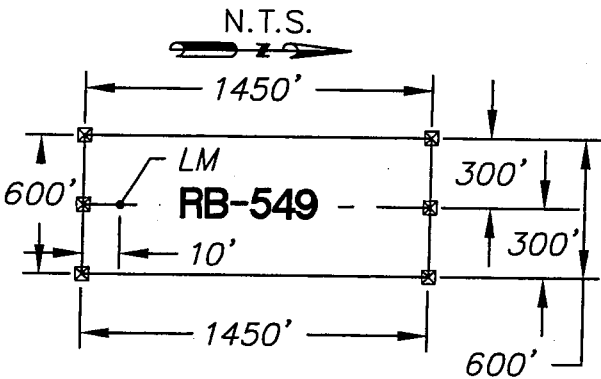
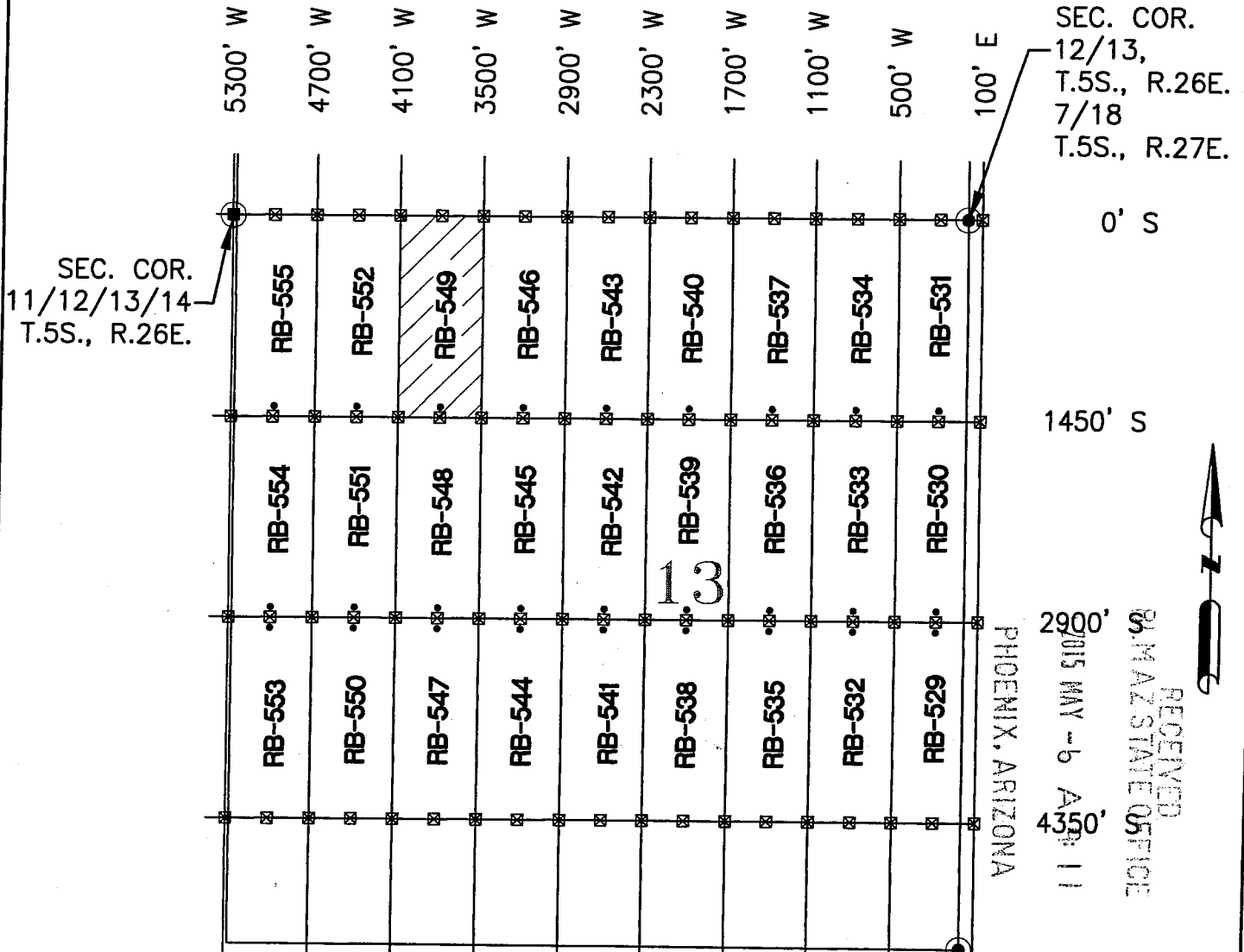

- ☒ INDICATES CORNER OF LODE CLAIM. SET 2"x2"x5' WOODEN POST (TYPICAL)
- INDICATES LOCATION MONUMENT. SET 2"x2"x5' WOODEN POST WITH SIGN (TYPICAL)

LOCATORS:  
 FREEPORT MINERALS CORP.  
 PO BOX 1019  
 SAFFORD AZ 85548

CLAIM ACREAGE = 20.0 AC  
 WC = WITNESS CORNER NORTH  
 OF SIDE LINE

**Entellus™**  
 2255 N. 44th Street Suite 125  
 Phoenix, AZ 85008.3279  
 Tel 602.244.2566  
 Fax 602.244.8947  
 Website: www.Entellus.com

LOCATION NOTICE FOR LODE MINING CLAIM

Amendment BLM Serial # \_\_\_\_\_

NOTICE IS HEREBY GIVEN that the Red Bull - 551

\_\_\_\_\_ lode mining claim has been located

by Freeport Minerals Corporation whose current mailing

address is P.O. Box 1019

Safford, Arizona 85548

RECEIVED  
BLM AZ STATE OFFICE  
2015 MAY -6 A 9:11  
PHOENIX, ARIZONA

BLM  
Date  
Stamp

The general course of this claim is North to South and it is situated in \_\_\_\_\_ Graham

County, Arizona. This claim is 1450 feet in length and 600 feet in width.

20.0 Total Claim Acreage. This claim runs from the location monument on which this location notice

is posted on the centerline of the claim approximately 10 feet in a Southerly direction to the South

end line and 1440 feet in a Northerly direction to the North end line. This claim is marked by six monuments, one at each corner and one at the center of each end line of the claim.

The location monument on which this notice is posted is situated within Section 13 Township 5

S, Range 26 E, Gila Salt River Base and Meridian, Arizona and this claim encompasses portions

of the following quarter section(s), section(s), Township(s) and Range(s) SW 1/4 NW 1/4

Section 13 Township 5S Range 26E

Gila Salt River Base and Meridian, Arizona.

The locality of this claim with reference to some natural object or permanent monument and additional information

(if any) concerning its locality are as follows: The Northeast corner of the claim is 1450' South and 4100' West of the monument at the

Northeast Corner of Section 13, Township 5S, Range 26E

The above information is shown on the attached map.

DATED AND POSTED on the ground this 16 day of April, 2015

LOCATOR(s)  AGENT

Print Name(s) Entellus, Inc. - Daniel G. Francetic, RLS

Signature(s) *Daniel G. Francetic*

Form MCF100  
Revised July 2014

This form is available from the Arizona Geological Survey and may be reproduced.

AMC432196

# RED BULL - 551 CLAIM

## LOCATION OF RED BULL-529 THROUGH RED BULL-555 LODE CLAIMS

LOCATED IN SECTIONS 13, & 14, T.5S., R.26E. AND SECTION 18, T.5S., R.27E.

GRAHAM COUNTY, ARIZONA

ALL CLAIMS ARE 1450' IN LENGTH AND 600' IN WIDTH UNLESS NOTED

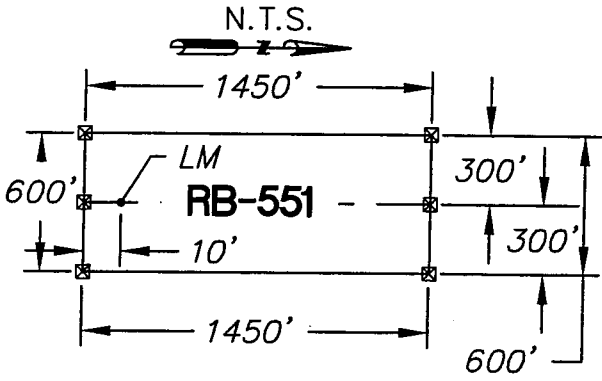
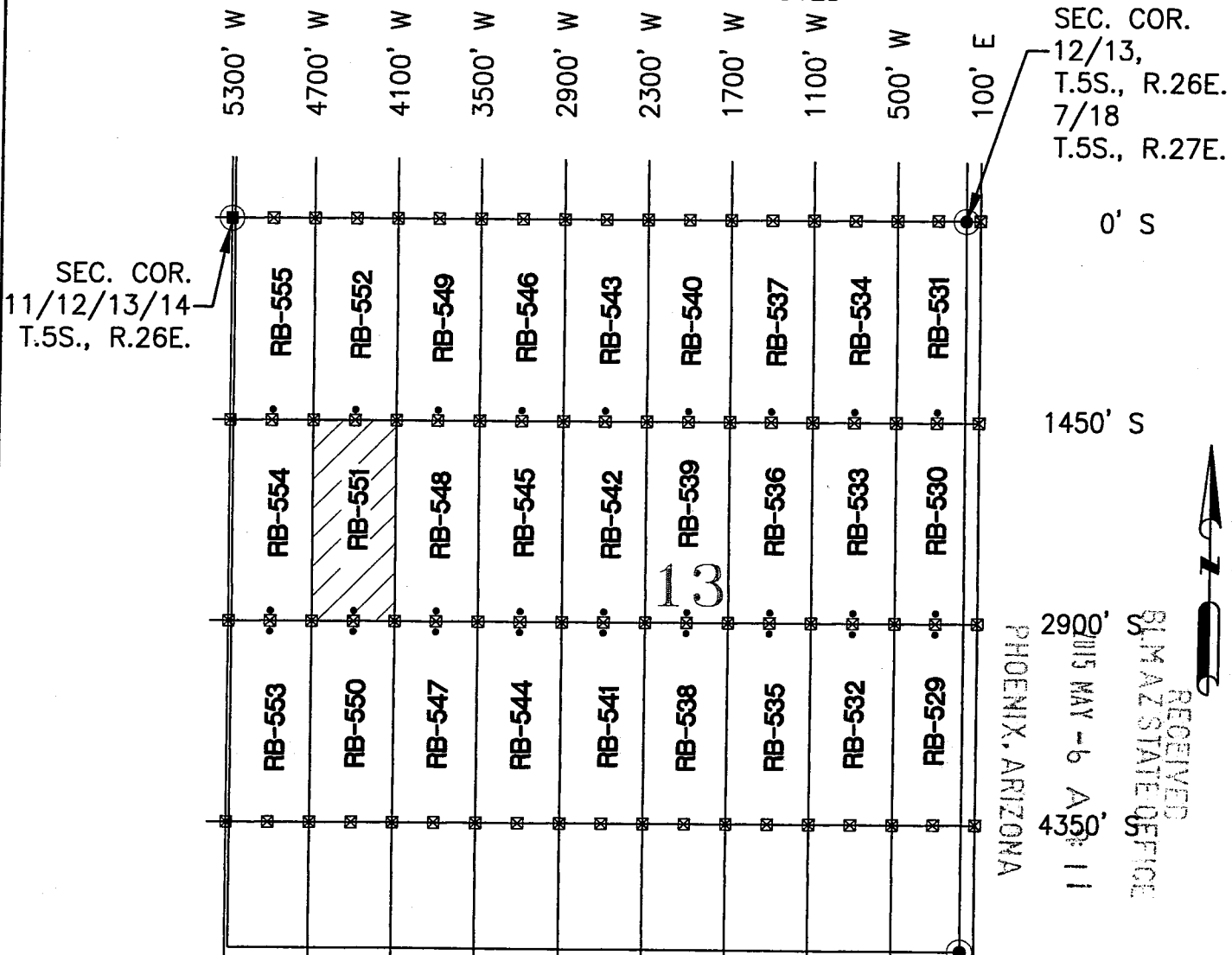

- ☒ INDICATES CORNER OF LODE CLAIM. SET 2"x2"x5' WOODEN POST (TYPICAL)
- INDICATES LOCATION MONUMENT. SET 2"x2"x5' WOODEN POST WITH SIGN (TYPICAL)

CLAIM ACREAGE = 20.0 AC  
 WC = WITNESS CORNER NORTH OF SIDE LINE

LOCATORS:  
 FREEPORT MINERALS CORP.  
 PO BOX 1019  
 SAFFORD AZ 85548

**Entellus™**  
 2255 N. 44th Street Suite 125  
 Phoenix, AZ 85008.3279  
 Tel 602.244.2566  
 Fax 602.244.8947  
 Website: www.Entellus.com

RECEIVED  
 MINNESOTA STATE OFFICE  
 PHOENIX, ARIZONA  
 MAY 9 - 6 AM '11

LOCATION NOTICE FOR LODE MINING CLAIM

Amendment BLM Serial # \_\_\_\_\_

NOTICE IS HEREBY GIVEN that the Red Bull - 552

\_\_\_\_\_ lode mining claim has been located

by Freeport Minerals Corporation whose current mailing

address is P.O. Box 1019

Safford, Arizona 85548

The general course of this claim is North to South and it is situated in

County, Arizona. This claim is 1450 feet in length and 600 feet in width.

20.0 Total Claim Acreage. This claim runs from the location monument on which this location notice

is posted on the centerline of the claim approximately 10 feet in a Southerly direction to the South

end line and 1440 feet in a Northerly direction to the North end line. This claim is marked by six

monuments, one at each corner and one at the center of each end line of the claim.

The location monument on which this notice is posted is situated within Section 13 Township 5

S, Range 26 E, Gila Salt River Base and Meridian, Arizona and this claim encompasses portions

of the following quarter section(s), section(s), Township(s) and Range(s) NW 1/4

Section 13 Township 5S Range 26E

Gila Salt River Base and Meridian, Arizona.

The locality of this claim with reference to some natural object or permanent monument and additional information

(if any) concerning its locality are as follows: The Northeast corner of the claim is 4100' West of the monument at the

Northeast Corner of Section 13, Township 5S, Range 26E on the section line

The above information is shown on the attached map.

DATED AND POSTED on the ground this 16 day of April, 2015.

LOCATOR(s)  AGENT

Print Name(s) Entellus, Inc. - Daniel G. Francetic, RLS

Signature(s) *Daniel G. Francetic*

RECEIVED  
BLM AZ STATE OFFICE  
2015 MAY -6 A 9:11  
PHOENIX, ARIZONA  
BLM  
Date  
Stamp  
Graham

AMC 432197

# RED BULL - 552 CLAIM

## LOCATION OF RED BULL-529 THROUGH RED BULL-555 LODE CLAIMS

LOCATED IN SECTIONS 13, & 14, T.5S., R.26E. AND SECTION 18, T.5S., R.27E.

GRAHAM COUNTY, ARIZONA

ALL CLAIMS ARE 1450' IN LENGTH AND 600' IN WIDTH UNLESS NOTED

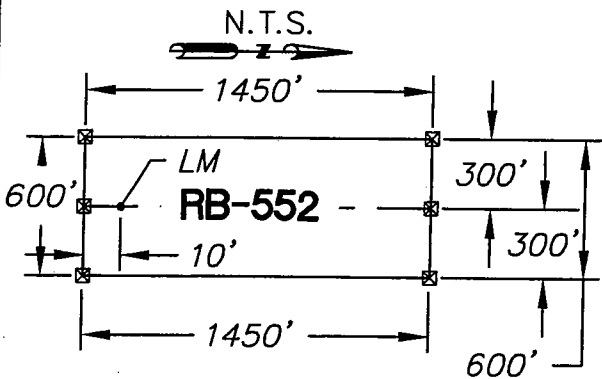
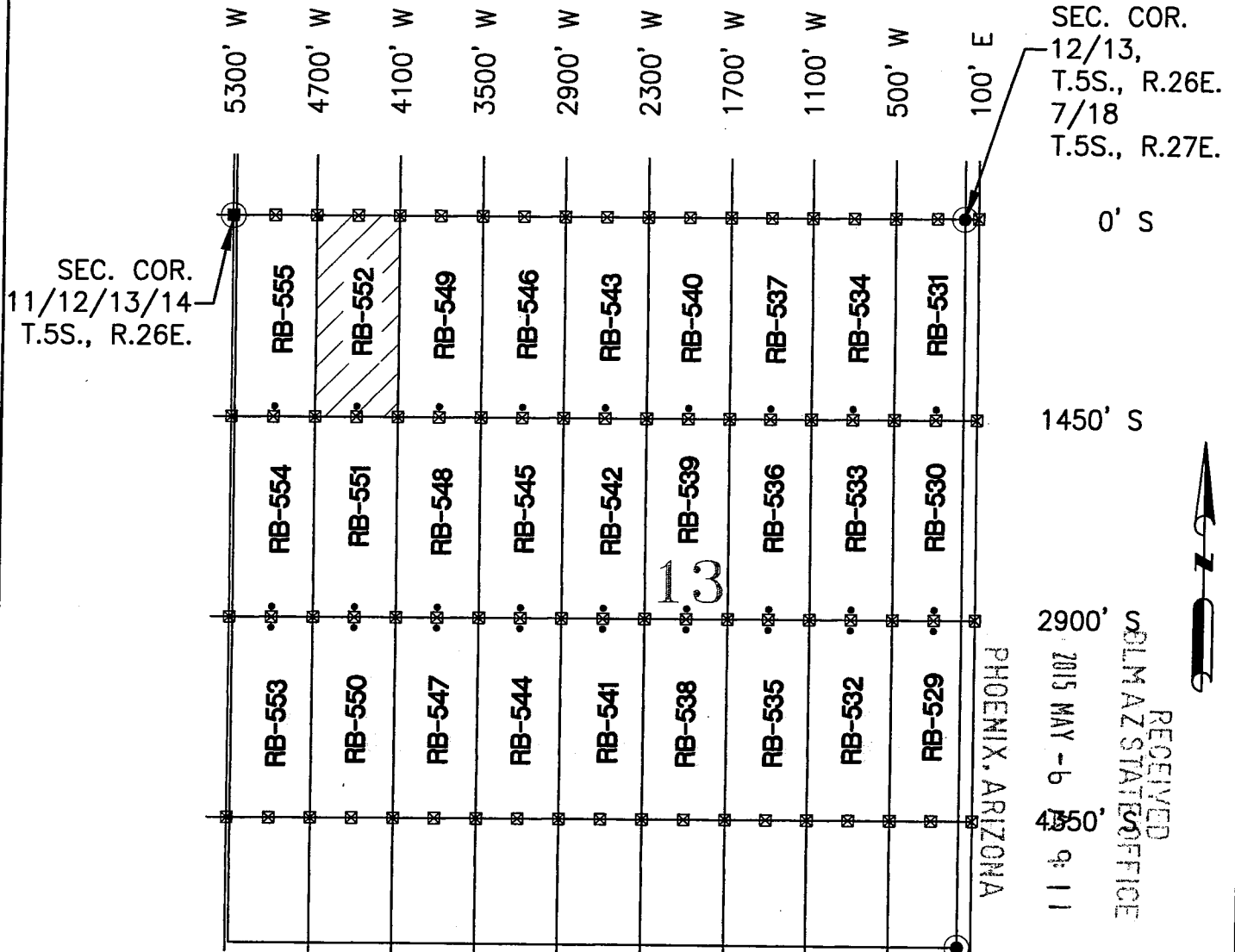

- ☒ INDICATES CORNER OF LODE CLAIM. SET 2"x2"x5' WOODEN POST (TYPICAL)
- INDICATES LOCATION MONUMENT. SET 2"x2"x5' WOODEN POST WITH SIGN (TYPICAL)

LOCATORS:  
 FREEPORT MINERALS CORP.  
 PO BOX 1019  
 SAFFORD AZ 85548

CLAIM ACREAGE = 20.0 AC  
 WC = WITNESS CORNER NORTH  
 OF SIDE LINE

**Entellus™**  
 2255 N. 44th Street Suite 125  
 Phoenix, AZ 85008.3279  
 Tel 602.244.2566  
 Fax 602.244.8947  
 Website: www.Entellus.com

RECEIVED  
 SOLIMAZ STATE OFFICE  
 2015 MAY - 6 9 11

LOCATION NOTICE FOR LODE MINING CLAIM

Amendment BLM Serial # \_\_\_\_\_

NOTICE IS HEREBY GIVEN that the Red Bull - 554

\_\_\_\_\_ lode mining claim has been located

by Freeport Minerals Corporation whose current mailing

address is P.O. Box 1019

Safford, Arizona 85548

RECEIVED  
BLM AZ STATE OFFICE  
2015 MAY -6 A 9:11  
PHOENIX, ARIZONA  
BLM  
Date  
Stamp

The general course of this claim is North to South and it is situated in Graham

County, Arizona. This claim is 1450 feet in length and 600 feet in width.

20.0 Total Claim Acreage. This claim runs from the location monument on which this location notice

is posted on the centerline of the claim approximately 10 feet in a Southerly direction to the South

end line and 1440 feet in a Northerly direction to the North end line. This claim is marked by six

monuments, one at each corner and one at the center of each end line of the claim.

The location monument on which this notice is posted is situated within Section 13 Township 5

S, Range 26 E, Gila Salt River Base and Meridian, Arizona and this claim encompasses portions

of the following quarter section(s), section(s), Township(s) and Range(s) SW 1/4, NW 1/4 Section 13 Township 5 S Range 26E

SE 1/4, NE 1/4 Section 14 Township 5S Range 26E

Gila Salt River Base and Meridian, Arizona.

The locality of this claim with reference to some natural object or permanent monument and additional information

(if any) concerning its locality are as follows: The Northeast corner of the claim is 1450' South and 4700' West of the monument at the

Northeast Corner of Section 13, Township 5S, Range 26E

The above information is shown on the attached map.

DATED AND POSTED on the ground this 16 day of April, 2015.

LOCATOR(s)  AGENT

Print Name(s) Entellus, Inc. - Daniel G. Francetic, RLS

Signature(s) *Daniel G. Francetic*

Form MCF100  
Revised July 2014

AMC432198



# RED BULL - 554 CLAIM

## LOCATION OF RED BULL-529 THROUGH RED BULL-555 LODE CLAIMS

LOCATED IN SECTIONS 13, & 14, T.5S., R.26E. AND SECTION 18, T.5S., R.27E.

GRAHAM COUNTY, ARIZONA

ALL CLAIMS ARE 1450' IN LENGTH AND 600' IN WIDTH UNLESS NOTED

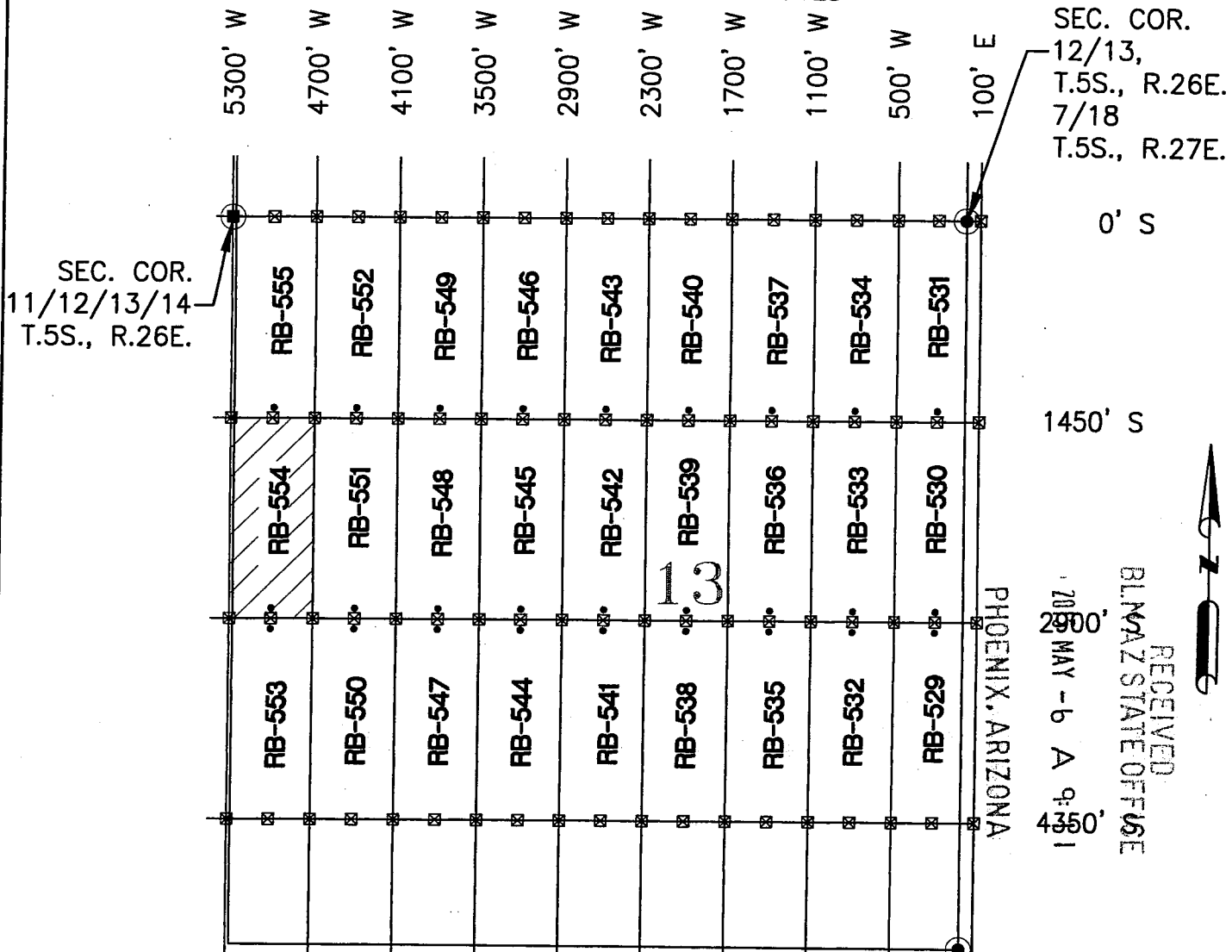

SEC. COR.  
11/12/13/14  
T.5S., R.26E.

SEC. COR.  
12/13,  
T.5S., R.26E.  
7/18  
T.5S., R.27E.

PHOENIX, ARIZONA

RECEIVED  
BLM AZ STATE OFFICE  
MAY - 6 2006

SEC. COR.  
13/24.  
T.5S., R.26E.  
18/19  
T.5S., R.27E.

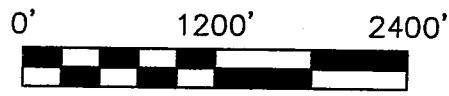
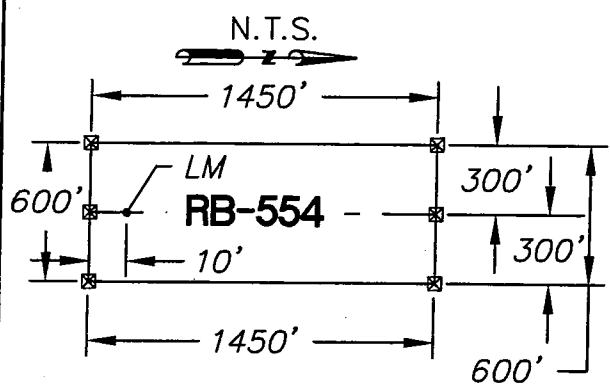

- ☒ INDICATES CORNER OF LODE CLAIM. SET 2"x2"x5' WOODEN POST (TYPICAL)
- INDICATES LOCATION MONUMENT. SET 2"x2"x5' WOODEN POST WITH SIGN (TYPICAL)

LOCATORS:  
FREEPORT MINERALS CORP.  
PO BOX 1019  
SAFFORD AZ 85548

CLAIM ACREAGE = 20.0 AC  
WC = WITNESS CORNER NORTH  
OF SIDE LINE

**Entellus™**  
2255 N. 44th Street Suite 125  
Phoenix, AZ 85008.3279  
Tel 602.244.2566  
Fax 602.244.8947  
Website: www.Entellus.com

LOCATION NOTICE FOR LODE MINING CLAIM

Amendment BLM Serial # \_\_\_\_\_

NOTICE IS HEREBY GIVEN that the Red Bull - 555

\_\_\_\_\_ lode mining claim has been located

by Freeport Minerals Corporation whose current mailing

address is P.O. Box 1019

Safford, Arizona 85548

The general course of this claim is North to South and it is situated in

County, Arizona. This claim is 1450 feet in length and 600 feet in width.

20.0 Total Claim Acreage. This claim runs from the location monument on which this location notice

is posted on the centerline of the claim approximately 10 feet in a Southerly direction to the South

end line and 1440 feet in a Northerly direction to the North end line. This claim is marked by six

monuments, one at each corner and one at the center of each end line of the claim.

The location monument on which this notice is posted is situated within Section 13 Township 5

S, Range 26 E, Gila Salt River Base and Meridian, Arizona and this claim encompasses portions

of the following quarter section(s), section(s), Township(s) and Range(s) NW 1/4 Section 13 Township 5 S Range 26E

NE 1/4 Section 14 Township 5S Range 26E

Gila Salt River Base and Meridian, Arizona.

The locality of this claim with reference to some natural object or permanent monument and additional information

(if any) concerning its locality are as follows: The Northeast corner of the claim is 4700' West of the monument at the

Northeast Corner of Section 13, Township 5S, Range 26E on the section line

The above information is shown on the attached map.

DATED AND POSTED on the ground this 16 day of April, 2015.

LOCATOR(s)  AGENT

Print Name(s) Entellus, Inc. - Daniel G. Francetic, RLS

Signature(s) *Daniel G. Francetic*

RECEIVED  
BLM AZ STATE OFFICE  
2015 MAY -6 A 9 11  
PHOENIX, ARIZONA  
Graham  
BLM  
Date  
Stamp

AMC 432199

Form MCF100  
Revised July 2014

# RED BULL - 555 CLAIM

## LOCATION OF RED BULL-529 THROUGH RED BULL-555 LODE CLAIMS

LOCATED IN SECTIONS 13, & 14, T.5S., R.26E. AND SECTION 18, T.5S., R.27E.

GRAHAM COUNTY, ARIZONA

ALL CLAIMS ARE 1450' IN LENGTH AND 600' IN WIDTH UNLESS NOTED

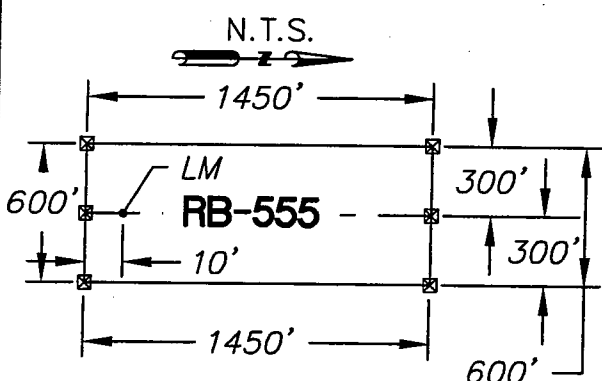
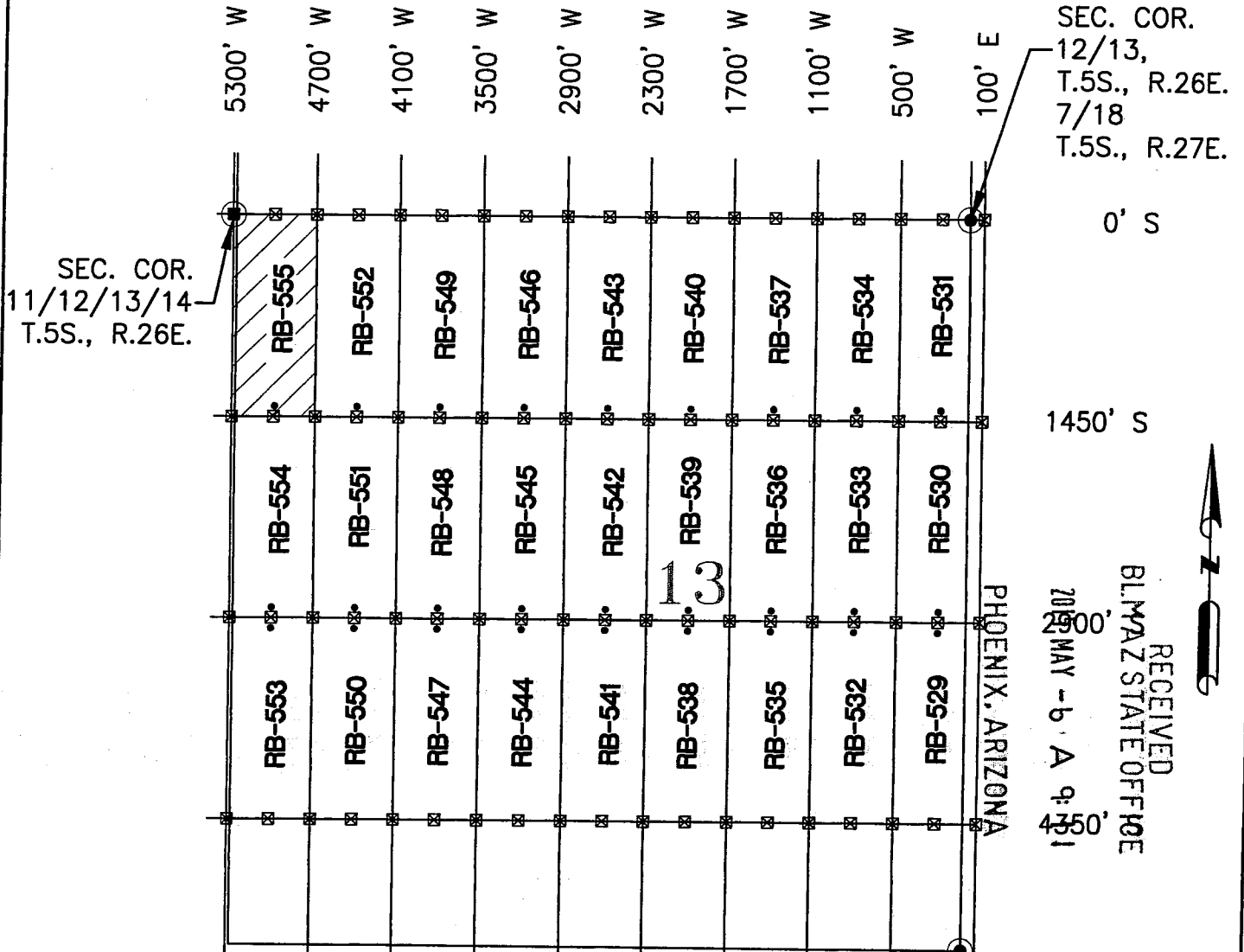

- ☒ INDICATES CORNER OF LODE CLAIM. SET 2"x2"x5' WOODEN POST (TYPICAL)
- INDICATES LOCATION MONUMENT. SET 2"x2"x5' WOODEN POST WITH SIGN (TYPICAL)

CLAIM ACREAGE = 20.0 AC  
 WC = WITNESS CORNER NORTH OF SIDE LINE

LOCATORS:  
 FREEPORT MINERALS CORP.  
 PO BOX 1019  
 SAFFORD AZ 85548

**Entellus™**  
 2255 N. 44th Street Suite 125  
 Phoenix, AZ 85008.3279  
 Tel 602.244.2566  
 Fax 602.244.8947  
 Website: www.Entellus.com

RECEIVED  
 BLM/AZ STATE OFFICE  
 2015 MAY - 6 A 9:11  
 4:50

**LOCATION NOTICE FOR LODE MINING CLAIM**

Amendment BLM Serial # \_\_\_\_\_

NOTICE IS HEREBY GIVEN that the Red Bull - 556

\_\_\_\_\_ lode mining claim has been located

by Freeport Minerals Corporation whose current mailing

address is P.O. Box 1019

Safford, Arizona 85548

The general course of this claim is North to South and it is situated in \_\_\_\_\_

Graham

County, Arizona. This claim is 1450 feet in length and 600 feet in width.

20.0 Total Claim Acreage. This claim runs from the location monument on which this location notice

is posted on the centerline of the claim approximately 10 feet in a Northerly direction to the North

end line and 1440 feet in a Southerly direction to the South end line. This claim is marked by six

monuments, one at each corner and one at the center of each end line of the claim.

The location monument on which this notice is posted is situated within Section 12 Township 5

S, Range 26 E, Gila Salt River Base and Meridian, Arizona and this claim encompasses portions

of the following quarter section(s), section(s), Township(s) and Range(s) SE 1/4

Section 12 Township 5S Range 26E SW 1/4 Section 7 Township 5S Range 27E

Gila Salt River Base and Meridian, Arizona.

The locality of this claim with reference to some natural object or permanent monument and additional information

(if any) concerning its locality are as follows: The Northeast corner of the claim is 3826' South and 100' East of the monument at the

Northeast Corner of Section 12, Township 5S, Range 26E

The above information is shown on the attached map.

DATED AND POSTED on the ground this 14 day of April, 2015.

LOCATOR(s)  AGENT

Print Name(s) Entellus, Inc. - Daniel G. Francetic, RLS

Signature(s) *Daniel G. Francetic*

RECEIVED  
BLM AZ STATE OFFICE  
2015 MAY -6 A 9:09  
PHOENIX, ARIZONA  
BLM  
Date  
Stamp

AMC432200

Form MCF100  
Revised July 2014

This form is available from the Arizona Geological Survey and may be reproduced.

# RED BULL - 556 CLAIM

LOCATION RED BULL-556 THROUGH RED BULL-591 LODE CLAIMS

LOCATED IN SECTIONS 1, 2, 11, 12, T.5S., R.26E. AND SECTIONS 6, & 7, T.5S., R.27E.  
GRAHAM COUNTY, ARIZONA

ALL CLAIMS ARE 1450' IN LENGTH AND  
600' IN WIDTH UNLESS NOTED

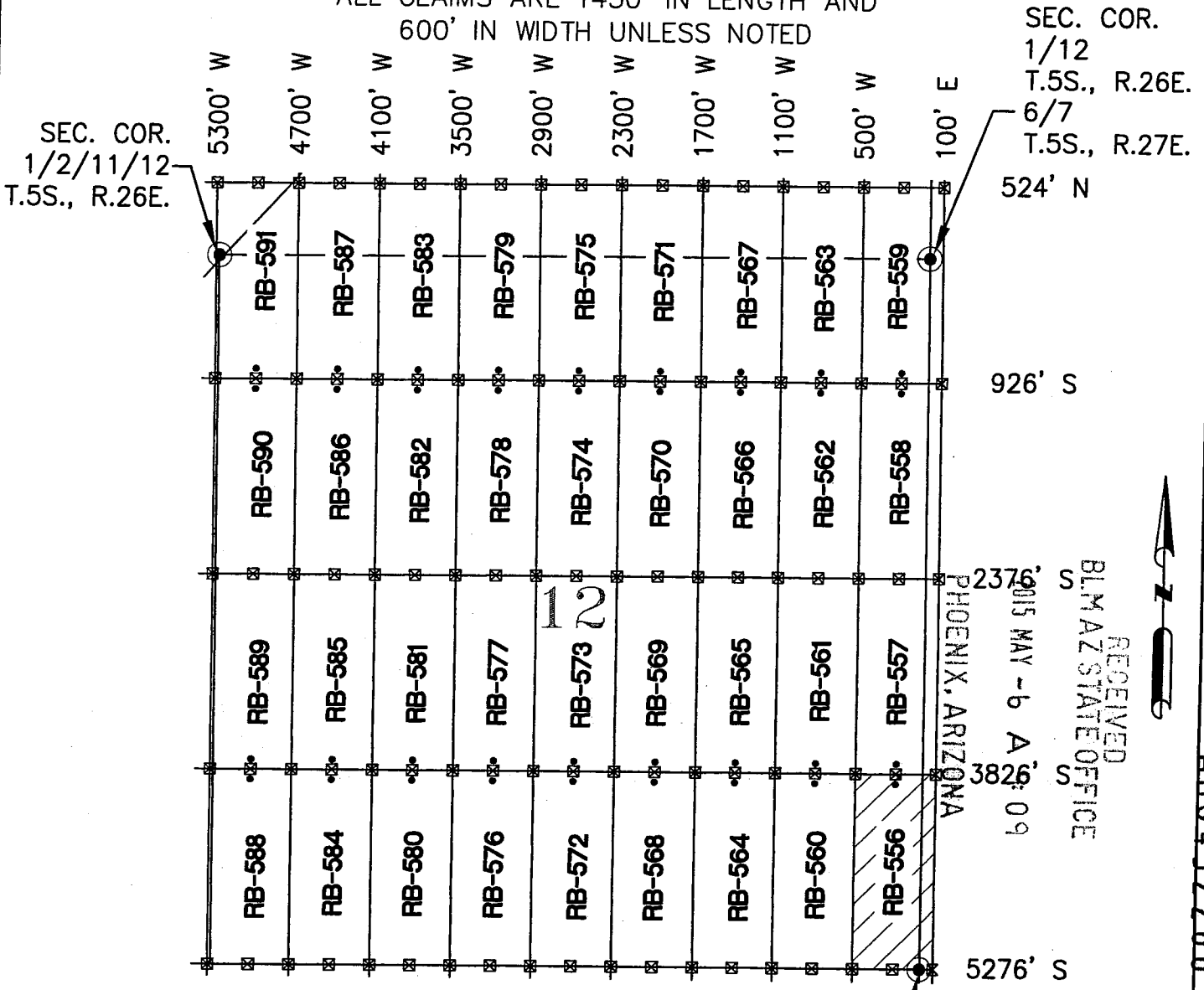

SEC. COR.  
1/12  
T.5S., R.26E.  
6/7  
T.5S., R.27E.  
524' N

SEC. COR.  
1/2/11/12  
T.5S., R.26E.

RECEIVED  
BLM AZ STATE OFFICE  
PHOENIX, ARIZONA  
MAY - 6 2009  
9:05 AM - 6 2009

ANCH 32200

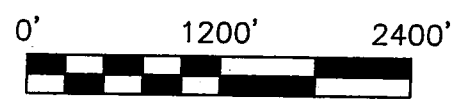
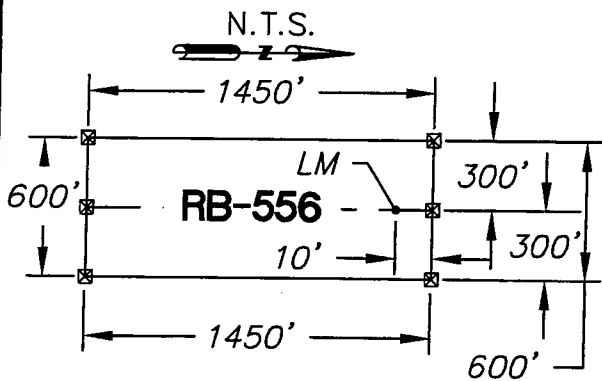

- ☒ INDICATES CORNER OF LODE CLAIM. SET 2"x2"x5' WOODEN POST (TYPICAL)
- INDICATES LOCATION MONUMENT. SET 2"x2"x5' WOODEN POST WITH SIGN (TYPICAL)

SEC. COR.  
12/13 T.5S., R.26E.  
7/18 T.5S., R.27E.

LOCATORS:  
FREEPORT MINERALS CORP.  
PO BOX 1019  
SAFFORD AZ 85548

CLAIM ACREAGE = 20.0 AC  
WC = WITNESS CORNER NORTH  
OF SIDE LINE

**Entellus™**  
2255 N. 44th Street Suite 125  
Phoenix, AZ 85008.3279  
Tel 602.244.2566  
Fax 602.244.8947  
Website: www.Entellus.com

**LOCATION NOTICE FOR LODE MINING CLAIM**

Amendment BLM Serial # \_\_\_\_\_

NOTICE IS HEREBY GIVEN that the Red Bull - 557

\_\_\_\_\_ lode mining claim has been located

by Freeport Minerals Corporation whose current mailing

address is P.O. Box 1019

Safford, Arizona 85548

The general course of this claim is North to South and it is situated in Graham

County, Arizona. This claim is 1450 feet in length and 600 feet in width.

20.0 Total Claim Acreage. This claim runs from the location monument on which this location notice

is posted on the centerline of the claim approximately 10 feet in a Southerly direction to the South

end line and 1440 feet in a Northerly direction to the North end line. This claim is marked by six

monuments, one at each corner and one at the center of each end line of the claim.

The location monument on which this notice is posted is situated within Section 12 Township 5

S, Range 26 E, Gila Salt River Base and Meridian, Arizona and this claim encompasses portions

of the following quarter section(s), section(s), Township(s) and Range(s) SE 1/4, NE 1/4

Section 12 Township 5S Range 26E SW 1/4, NW 1/4 Section 7 Township 5S Range 27E

Gila Salt River Base and Meridian, Arizona.

The locality of this claim with reference to some natural object or permanent monument and additional information

(if any) concerning its locality are as follows: The Northeast corner of the claim is 2376' South and 100' East of the monument at the

Northeast Corner of Section 12, Township 5S, Range 26E

The above information is shown on the attached map.

DATED AND POSTED on the ground this 14 day of April, 2015.

LOCATOR(s)  AGENT

Print Name(s) Entellus, Inc. - Daniel G. Francetic, RLS

Signature(s) *Daniel G. Francetic*

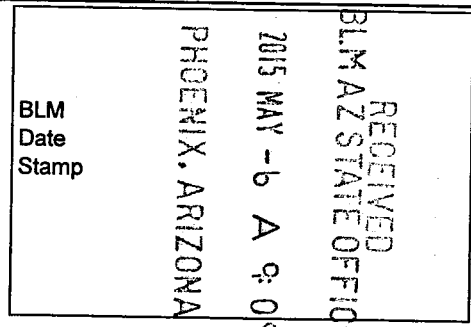

AN C 4 3 2 2 0 1

# RED BULL - 557 CLAIM

LOCATION OF RED BULL-556 THROUGH RED BULL-591 LODE CLAIMS

LOCATED IN SECTIONS 1, 2, 11, 12, T.5S., R.26E. AND SECTIONS 6, & 7, T.5S., R.27E.

GRAHAM COUNTY, ARIZONA

ALL CLAIMS ARE 1450' IN LENGTH AND 600' IN WIDTH UNLESS NOTED

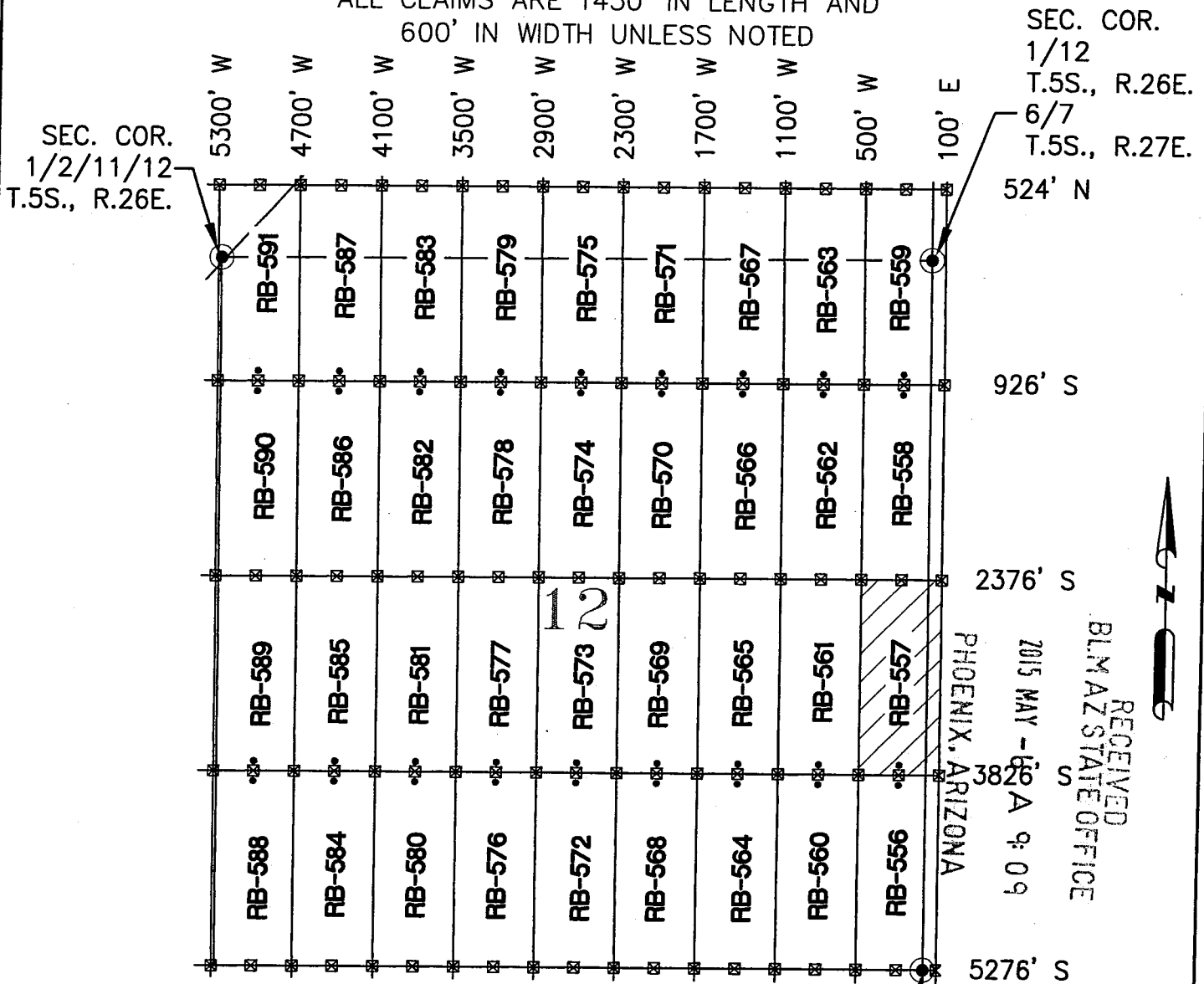

SEC. COR.  
1/12  
T.5S., R.26E.  
6/7  
T.5S., R.27E.

SEC. COR.  
1/2/11/12  
T.5S., R.26E.

524' N

926' S

2376' S

3826' S

5276' S

SEC. COR.  
12/13 T.5S., R.26E.  
7/18 T.5S., R.27E.

RECEIVED  
BLM AZ STATE OFFICE  
2015 MAY - 16 A 9:09  
PHOENIX, ARIZONA

N.T.S.

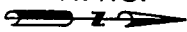

0' 1200' 2400'

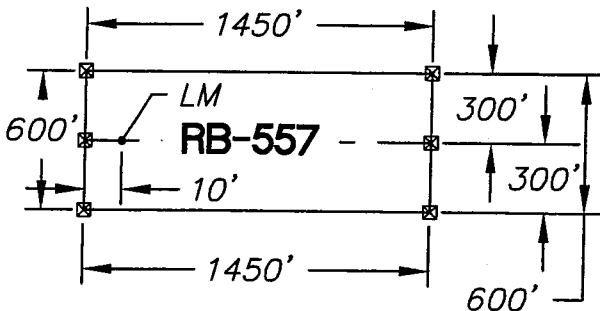

- ☒ INDICATES CORNER OF LODE CLAIM. SET 2"x2"x5' WOODEN POST (TYPICAL)
- INDICATES LOCATION MONUMENT. SET 2"x2"x5' WOODEN POST WITH SIGN (TYPICAL)

LOCATORS:  
FREEPORT MINERALS CORP.  
PO BOX 1019  
SAFFORD AZ 85548

CLAIM ACREAGE = 20.0 AC  
WC = WITNESS CORNER NORTH  
OF SIDE LINE

 **Entellus™**  
2255 N. 44th Street Suite 125  
Phoenix, AZ 85008.3279  
Tel 602.244.2566  
Fax 602.244.8947  
Website: www.Entellus.com

**LOCATION NOTICE FOR LODE MINING CLAIM**

Amendment BLM Serial # \_\_\_\_\_

NOTICE IS HEREBY GIVEN that the Red Bull - 558

\_\_\_\_\_ lode mining claim has been located

by Freeport Minerals Corporation whose current mailing

address is P.O. Box 1019

Safford, Arizona 85548

The general course of this claim is North to South and it is situated in \_\_\_\_\_

County, Arizona. This claim is 1450 feet in length and 600 feet in width.

20.0 Total Claim Acreage. This claim runs from the location monument on which this location notice

is posted on the centerline of the claim approximately 10 feet in a Northerly direction to the North

end line and 1440 feet in a Southerly direction to the South end line. This claim is marked by six

monuments, one at each corner and one at the center of each end line of the claim.

The location monument on which this notice is posted is situated within Section 12 Township 5

S, Range 26 E, Gila Salt River Base and Meridian, Arizona and this claim encompasses portions

of the following quarter section(s), section(s), Township(s) and Range(s) NE 1/4

Section 12 Township 5S Range 26E NW 1/4 Section 7 Township 5S Range 27E

Gila Salt River Base and Meridian, Arizona.

The locality of this claim with reference to some natural object or permanent monument and additional information

(if any) concerning its locality are as follows: The Northeast corner of the claim is 926' South and 100' East of the monument at the

Northeast Corner of Section 12, Township 5S, Range 26E

The above information is shown on the attached map.

DATED AND POSTED on the ground this 15 day of April, 2015.

LOCATOR(s)  AGENT

Print Name(s) Entellus, Inc. - Daniel G. Francetic, RLS

Signature(s) [Handwritten Signature]

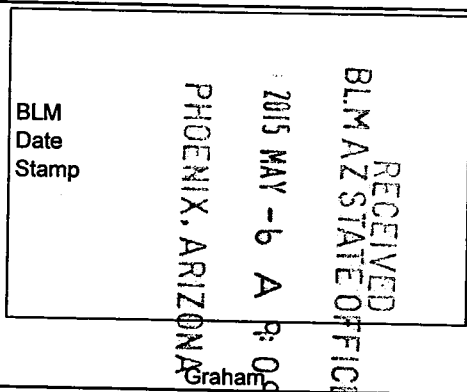

AMC432202



# RED BULL - 558 CLAIM

LOCATION OF RED BULL-556 THROUGH RED BULL-591 LODE CLAIMS

LOCATED IN SECTIONS 1, 2, 11, 12, T.5S., R.26E. AND SECTIONS 6, & 7, T.5S., R.27E.

GRAHAM COUNTY, ARIZONA

ALL CLAIMS ARE 1450' IN LENGTH AND 600' IN WIDTH UNLESS NOTED

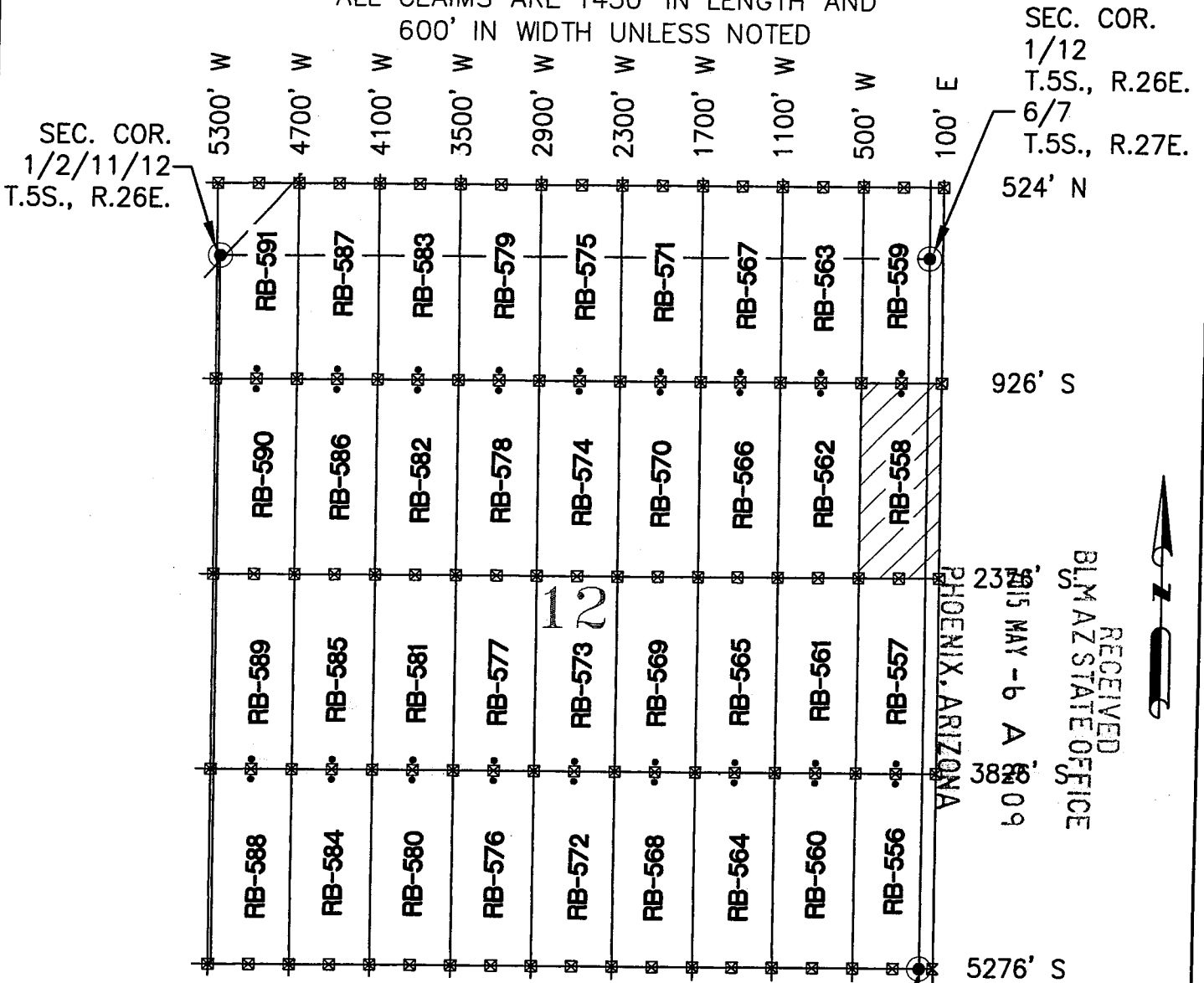

RECEIVED  
BLM AZ STATE OFFICE  
23 15  
MAY - 6 A  
38 09

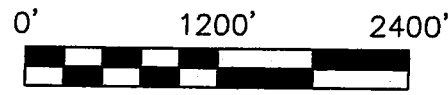
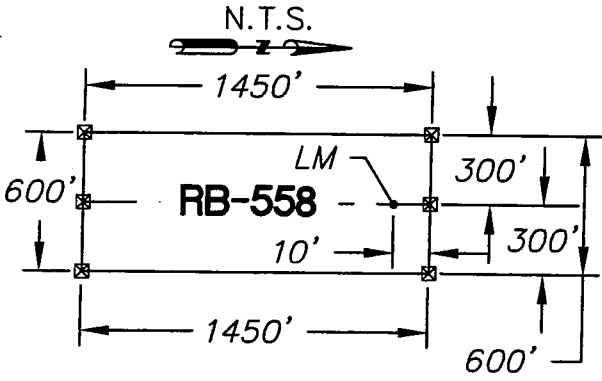

- ☒ INDICATES CORNER OF LODE CLAIM. SET 2"x2"x5' WOODEN POST (TYPICAL)
- INDICATES LOCATION MONUMENT. SET 2"x2"x5' WOODEN POST WITH SIGN (TYPICAL)

LOCATORS:  
FREEPORT MINERALS CORP.  
PO BOX 1019  
SAFFORD AZ 85548

CLAIM ACREAGE = 20.0 AC  
WC = WITNESS CORNER NORTH OF SIDE LINE

**Entellus™**  
2255 N. 44th Street Suite 125  
Phoenix, AZ 85008.3279  
Tel 602.244.2566  
Fax 602.244.8947  
Website: www.Entellus.com

**LOCATION NOTICE FOR LODE MINING CLAIM**

Amendment BLM Serial # \_\_\_\_\_

NOTICE IS HEREBY GIVEN that the Red Bull - 559

\_\_\_\_\_ lode mining claim has been located

by Freeport Minerals Corporation whose current mailing

address is P.O. Box 1019

Safford, Arizona 85548

The general course of this claim is North to South and it is situated in \_\_\_\_\_ Graham

County, Arizona. This claim is 1450 feet in length and 600 feet in width.

20.0 Total Claim Acreage. This claim runs from the location monument on which this location notice

is posted on the centerline of the claim approximately 10 feet in a Southerly direction to the South

end line and 1440 feet in a Northerly direction to the North end line. This claim is marked by six

monuments, one at each corner and one at the center of each end line of the claim.

The location monument on which this notice is posted is situated within Section 12 Township 5

S, Range 26 E, Gila Salt River Base and Meridian, Arizona and this claim encompasses portions

of the following quarter section(s), section(s), Township(s) and Range(s) NE 1/4 Section 12 Township 5S Range 26E

NW 1/4 Section 7 Township 5S Range 27E, SW 1/4 Section 6 Township 5S Range 27E, SE 1/4 Section 1 Township 5S Range 26E

Gila Salt River Base and Meridian, Arizona.

The locality of this claim with reference to some natural object or permanent monument and additional information

(if any) concerning its locality are as follows: The Northeast corner of the claim is 524' North and 100' East of the monument at the

Northeast Corner of Section 12, Township 5S, Range 26E

RECEIVED  
BLM AZ STATE OFFICE  
2015 MAY -6 A 9:09  
PHOENIX, ARIZONA  
BLM  
Date  
Stamp

The above information is shown on the attached map.

DATED AND POSTED on the ground this 15 day of April, 2015.

LOCATOR(s)  AGENT

Print Name(s) Entellus, Inc. - Daniel G. Francetic, RLS

Signature(s) [Handwritten Signature]

Form MCF100  
Revised July 2014

This form is available from the Arizona Geological Survey and may be reproduced.

AMC 432203

# RED BULL - 559 CLAIM

LOCATION **U** RED BULL-556 THROUGH RED BULL-591 LODE CLAIMS

LOCATED IN SECTIONS 1, 2, 11, 12, T.5S., R.26E. AND SECTIONS 6, & 7, T.5S., R.27E.  
GRAHAM COUNTY, ARIZONA

ALL CLAIMS ARE 1450' IN LENGTH AND  
600' IN WIDTH UNLESS NOTED

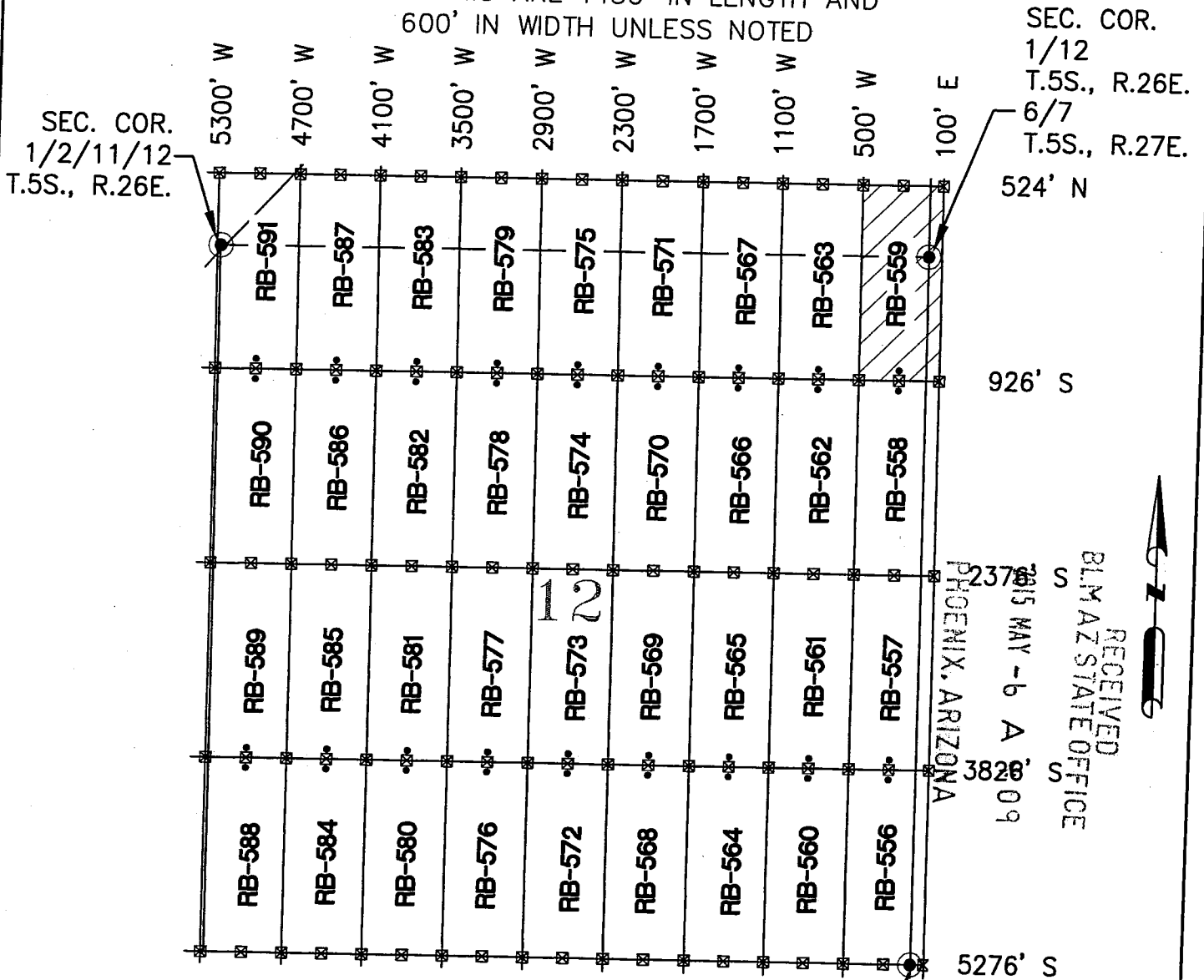

RECEIVED  
BLM AZ STATE OFFICE  
MAY - 6 A 09  
2376 S  
PHOENIX, ARIZONA  
3826 S

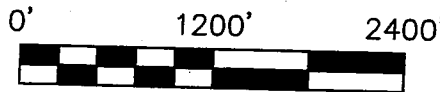
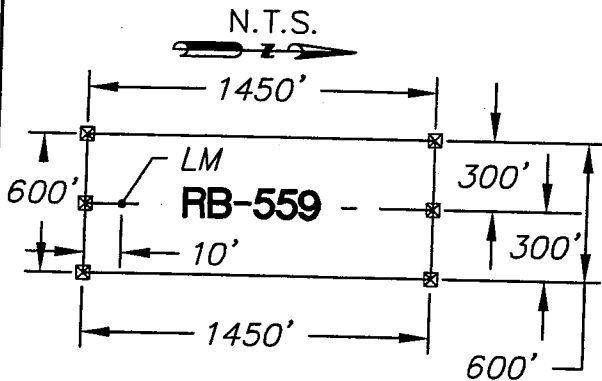

- ☒ INDICATES CORNER OF LODE CLAIM. SET 2"x2"x5' WOODEN POST (TYPICAL)
- INDICATES LOCATION MONUMENT. SET 2"x2"x5' WOODEN POST WITH SIGN (TYPICAL)

LOCATORS:  
FREEPORT MINERALS CORP.  
PO BOX 1019  
SAFFORD AZ 85548

CLAIM ACREAGE = 20.0 AC  
WC = WITNESS CORNER NORTH  
OF SIDE LINE

**Entellus™**  
2255 N. 44th Street Suite 125  
Phoenix, AZ 85008.3279  
Tel 602.244.2566  
Fax 602.244.8947  
Website: www.Entellus.com

**LOCATION NOTICE FOR LODE MINING CLAIM**

Amendment BLM Serial # \_\_\_\_\_

NOTICE IS HEREBY GIVEN that the Red Bull - 560

\_\_\_\_\_ lode mining claim has been located

by Freeport Minerals Corporation whose current mailing

address is P.O. Box 1019

Safford, Arizona 85548

The general course of this claim is North to South and it is situated in Graham

County, Arizona. This claim is 1450 feet in length and 600 feet in width.

20.0 Total Claim Acreage. This claim runs from the location monument on which this location notice is posted on the centerline of the claim approximately 10 feet in a Northerly direction to the North end line and 1440 feet in a Southerly direction to the South end line. This claim is marked by six

monuments, one at each corner and one at the center of each end line of the claim.

The location monument on which this notice is posted is situated within Section 12 Township 5

S, Range 26 E, Gila Salt River Base and Meridian, Arizona and this claim encompasses portions of the following quarter section(s), section(s), Township(s) and Range(s) SE 1/4

Section 12 Township 5S Range 26E

Gila Salt River Base and Meridian, Arizona.

The locality of this claim with reference to some natural object or permanent monument and additional information (if any) concerning its locality are as follows:

The Northeast corner of the claim is 3826' South and 500' West of the monument at the Northeast Corner of Section 12, Township 5S, Range 26E

DATED AND POSTED on the ground this 14 day of April, 2015. The above information is shown on the attached map.

LOCATOR(s)  AGENT

Print Name(s) Entellus, Inc. - Daniel G. Francetic, RLS

Signature(s) *Daniel G. Francetic*

RECEIVED  
BLM AZ STATE OFFICE  
2015 MAY -6 A 9: 09  
PHOENIX, ARIZONA  
BLM  
Date  
Stamp

AMC 432204

Form MCF100  
Revised July 2014

# RED BULL - 560 CLAIM

LOCATION **U** RED BULL-556 THROUGH RED BULL-591 LODE CLAIMS

LOCATED IN SECTIONS 1, 2, 11, 12, T.5S., R.26E. AND SECTIONS 6, & 7, T.5S., R.27E.  
GRAHAM COUNTY, ARIZONA

ALL CLAIMS ARE 1450' IN LENGTH AND  
600' IN WIDTH UNLESS NOTED

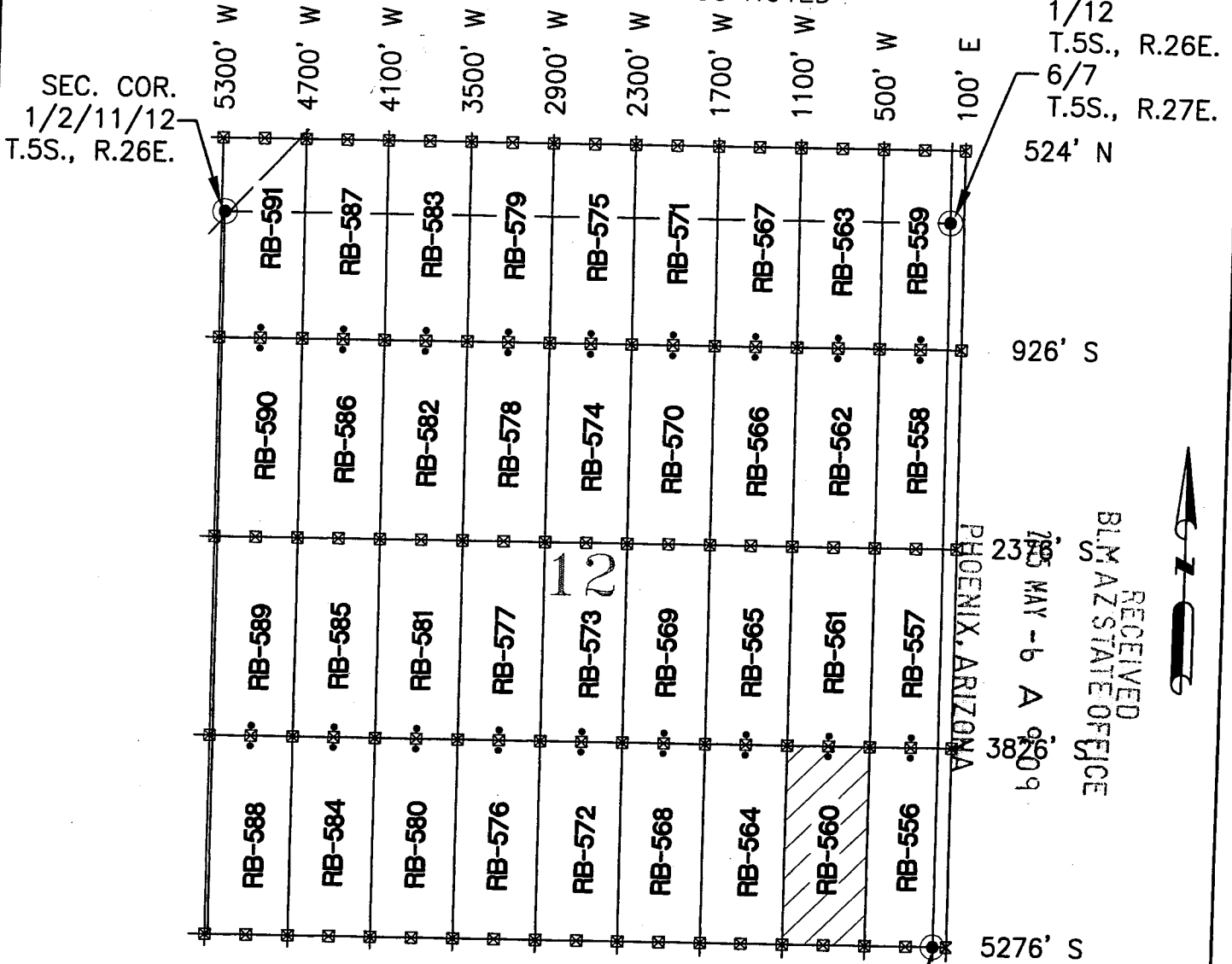

SEC. COR.  
1/12  
T.5S., R.26E.  
6/7  
T.5S., R.27E.

SEC. COR.  
1/2/11/12  
T.5S., R.26E.

524' N

926' S

PHOENIX, ARIZONA

RECEIVED  
BLM AZ STATE OFFICE  
MAY - 6 2009



5276' S

SEC. COR.  
12/13 T.5S., R.26E.  
7/18 T.5S., R.27E.

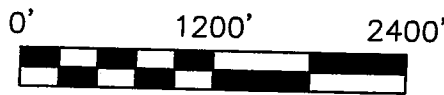
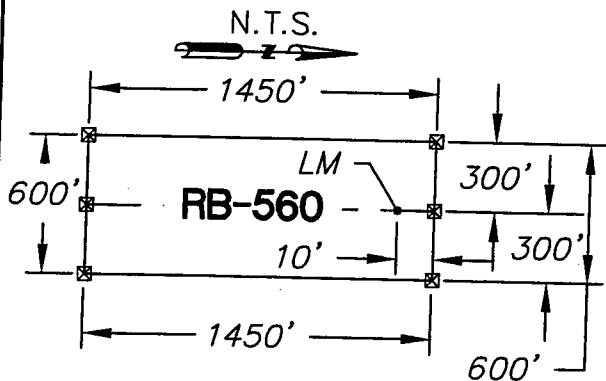

- ☒ INDICATES CORNER OF LODE CLAIM.  
SET 2"x2"x5' WOODEN POST (TYPICAL)
- INDICATES LOCATION  
MONUMENT. SET 2"x2"x5'  
WOODEN POST WITH SIGN  
(TYPICAL)

LOCATORS:  
FREEPORT MINERALS CORP.  
PO BOX 1019  
SAFFORD AZ 85548

CLAIM ACREAGE = 20.0 AC  
WC = WITNESS CORNER NORTH  
OF SIDE LINE

**Entellus™**  
2255 N. 44th Street Suite 125  
Phoenix, AZ 85008.3279  
Tel 602.244.2566  
Fax 602.244.8947  
Website: www.Entellus.com

**LOCATION NOTICE FOR LODE MINING CLAIM**

Amendment BLM Serial # \_\_\_\_\_

NOTICE IS HEREBY GIVEN that the Red Bull - 561

\_\_\_\_\_ lode mining claim has been located

by Freeport Minerals Corporation whose current mailing

address is P.O. Box 1019

Safford, Arizona 85548

RECEIVED  
BLM AZ STATE OFFICE  
2015 MAY -6 A 9:09  
PHOENIX, ARIZONA  
BLM  
Date  
Stamp

The general course of this claim is North to South and it is situated in Graham

County, Arizona. This claim is 1450 feet in length and 600 feet in width.

20.0 Total Claim Acreage. This claim runs from the location monument on which this location notice

is posted on the centerline of the claim approximately 10 feet in a Southerly direction to the South

end line and 1440 feet in a Northerly direction to the North end line. This claim is marked by six

monuments, one at each corner and one at the center of each end line of the claim.

The location monument on which this notice is posted is situated within Section 12 Township 5

S, Range 26 E, Gila Salt River Base and Meridian, Arizona and this claim encompasses portions

of the following quarter section(s), section(s), Township(s) and Range(s) SE 1/4 NE 1/4

Section 12 Township 5S Range 26E

Gila Salt River Base and Meridian, Arizona.

The locality of this claim with reference to some natural object or permanent monument and additional information

(if any) concerning its locality are as follows: The Northeast corner of the claim is 2376' South and 500' West of the monument at the

Northeast Corner of Section 12, Township 5S, Range 26E

The above information is shown on the attached map.

DATED AND POSTED on the ground this 14 day of April, 2015.

LOCATOR(s)  AGENT

Print Name(s) Entellus, Inc. - Daniel G. Francetic, RLS

Signature(s) [Handwritten Signature]

Form MCF100  
Revised July 2014

This form is available from the Arizona Geological Survey and may be reproduced.

AMC 432205

# RED BULL - 561 CLAIM

LOCATION OF RED BULL-556 THROUGH RED BULL-591 LODE CLAIMS

LOCATED IN SECTIONS 1, 2, 11, 12, T.5S., R.26E. AND SECTIONS 6, & 7, T.5S., R.27E.  
GRAHAM COUNTY, ARIZONA

ALL CLAIMS ARE 1450' IN LENGTH AND  
600' IN WIDTH UNLESS NOTED

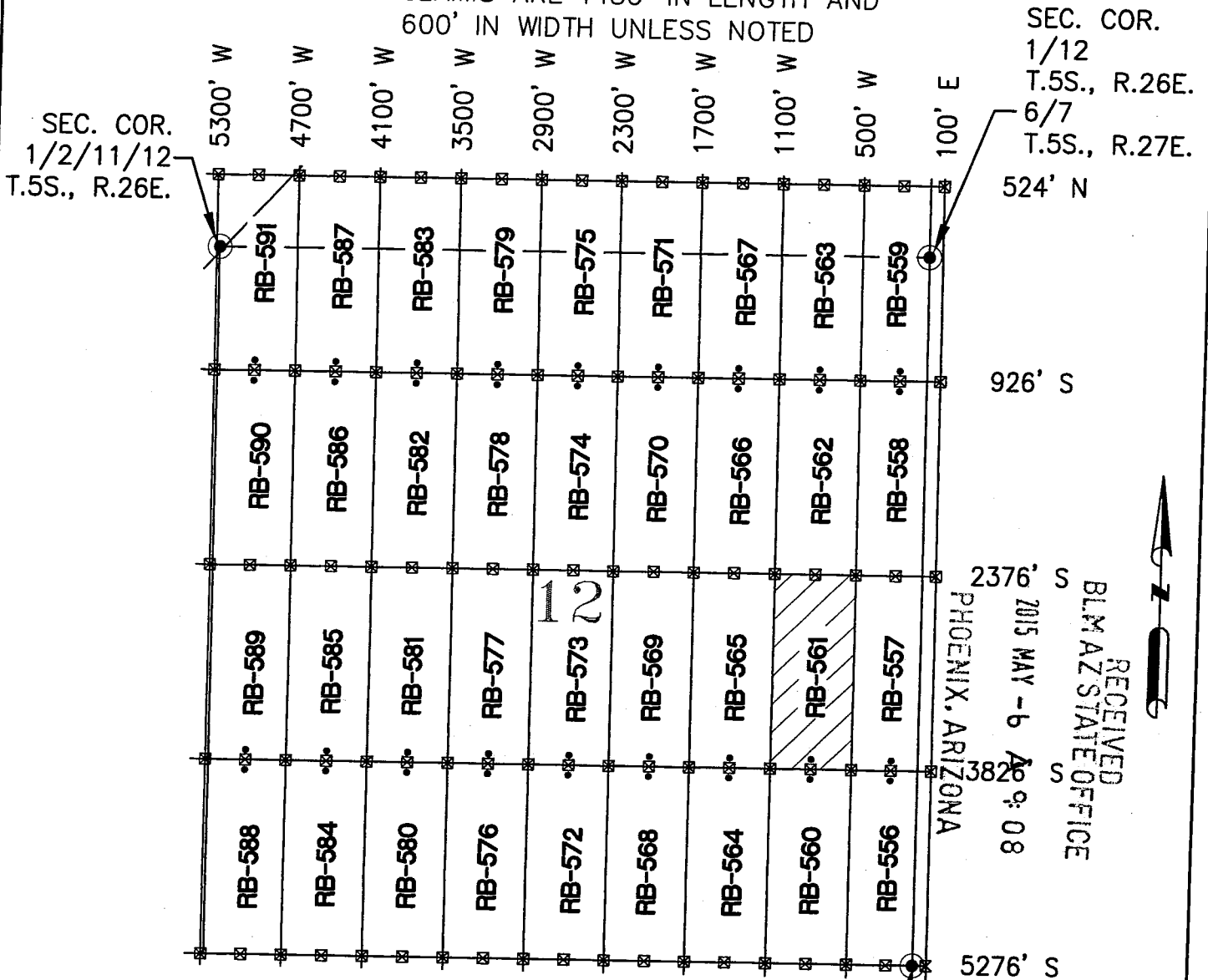

RECEIVED  
BLM AZ STATE OFFICE  
2015 MAY - 6 AM 9:08  
PHOENIX, ARIZONA

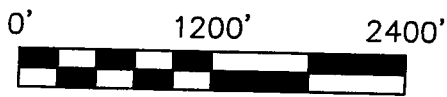
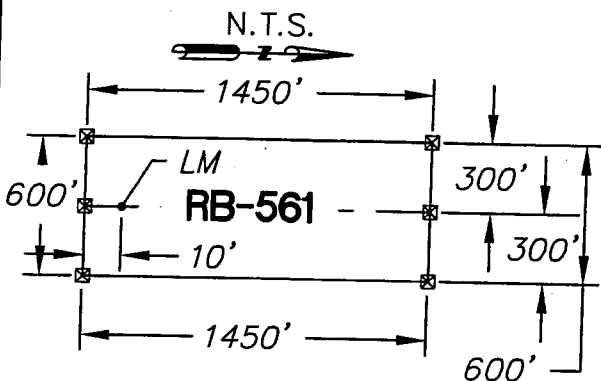

- ☒ INDICATES CORNER OF LODE CLAIM. SET 2"x2"x5' WOODEN POST (TYPICAL)
- INDICATES LOCATION MONUMENT. SET 2"x2"x5' WOODEN POST WITH SIGN (TYPICAL)

LOCATORS:  
FREEPORT MINERALS CORP.  
PO BOX 1019  
SAFFORD AZ 85548

CLAIM ACREAGE = 20.0 AC  
WC = WITNESS CORNER NORTH  
OF SIDE LINE



**Entellus™**  
2255 N. 44th Street Suite 125  
Phoenix, AZ 85008.3279  
Tel 602.244.2566  
Fax 602.244.8947  
Website: www.Entellus.com

SEC. COR.  
12/13 T.5S., R.26E.  
7/18 T.5S., R.27E.

**LOCATION NOTICE FOR LODE MINING CLAIM**

Amendment      BLM Serial # \_\_\_\_\_

NOTICE IS HEREBY GIVEN that the Red Bull - 562

\_\_\_\_\_ lode mining claim has been located

by Freeport Minerals Corporation whose current mailing

address is P.O. Box 1019

Safford, Arizona 85548

The general course of this claim is North to South and it is situated in \_\_\_\_\_ Graham

County, Arizona. This claim is 1450 feet in length and 600 feet in width.

20.0 Total Claim Acreage. This claim runs from the location monument on which this location notice is posted on the centerline of the claim approximately 10 feet in a Northerly direction to the North end line and 1440 feet in a Southerly direction to the South end line. This claim is marked by six

monuments, one at each corner and one at the center of each end line of the claim.

The location monument on which this notice is posted is situated within Section 12 Township 5 \_\_\_\_\_

S, Range 26 \_\_\_\_\_ E, Gila Salt River Base and Meridian, Arizona and this claim encompasses portions

of the following quarter section(s), section(s), Township(s) and Range(s) SE 1/4 NE 1/4

Section 12 Township 5S Range 26E

Gila Salt River Base and Meridian, Arizona.

The locality of this claim with reference to some natural object or permanent monument and additional information (if any) concerning its locality are as follows:

The Northeast corner of the claim is 926' South and 500' West of the monument at the Northeast Corner of Section 12, Township 5S, Range 26E

The above information is shown on the attached map.

DATED AND POSTED on the ground this 15 day of April, 2015.

LOCATOR(s)       AGENT

Print Name(s) Entellus, Inc. - Daniel G. Francetic, RLS

Signature(s) [Signature]

RECEIVED  
BLM AZ STATE OFFICE  
2015 MAY -6 A 9:08  
PHOENIX, ARIZONA  
BLM  
Date  
Stamp

Form MCF100  
Revised July 2014

This form is available from the Arizona Geological Survey and may be reproduced.

AMC432206



# RED BULL - 562 CLAIM

LOCATION  RED BULL-556 THROUGH RED BULL-591 LODE CLAIMS

LOCATED IN SECTIONS 1, 2, 11, 12, T.5S., R.26E. AND SECTIONS 6, & 7, T.5S., R.27E.  
GRAHAM COUNTY, ARIZONA

ALL CLAIMS ARE 1450' IN LENGTH AND  
600' IN WIDTH UNLESS NOTED

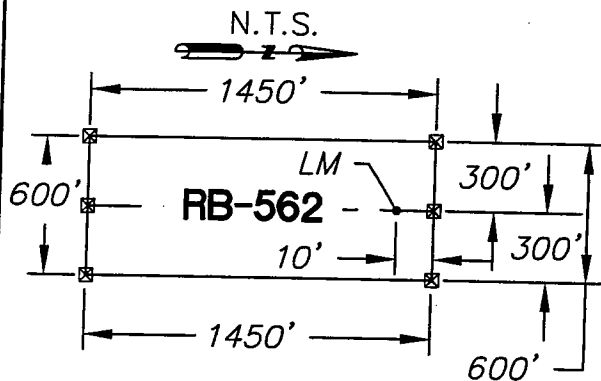
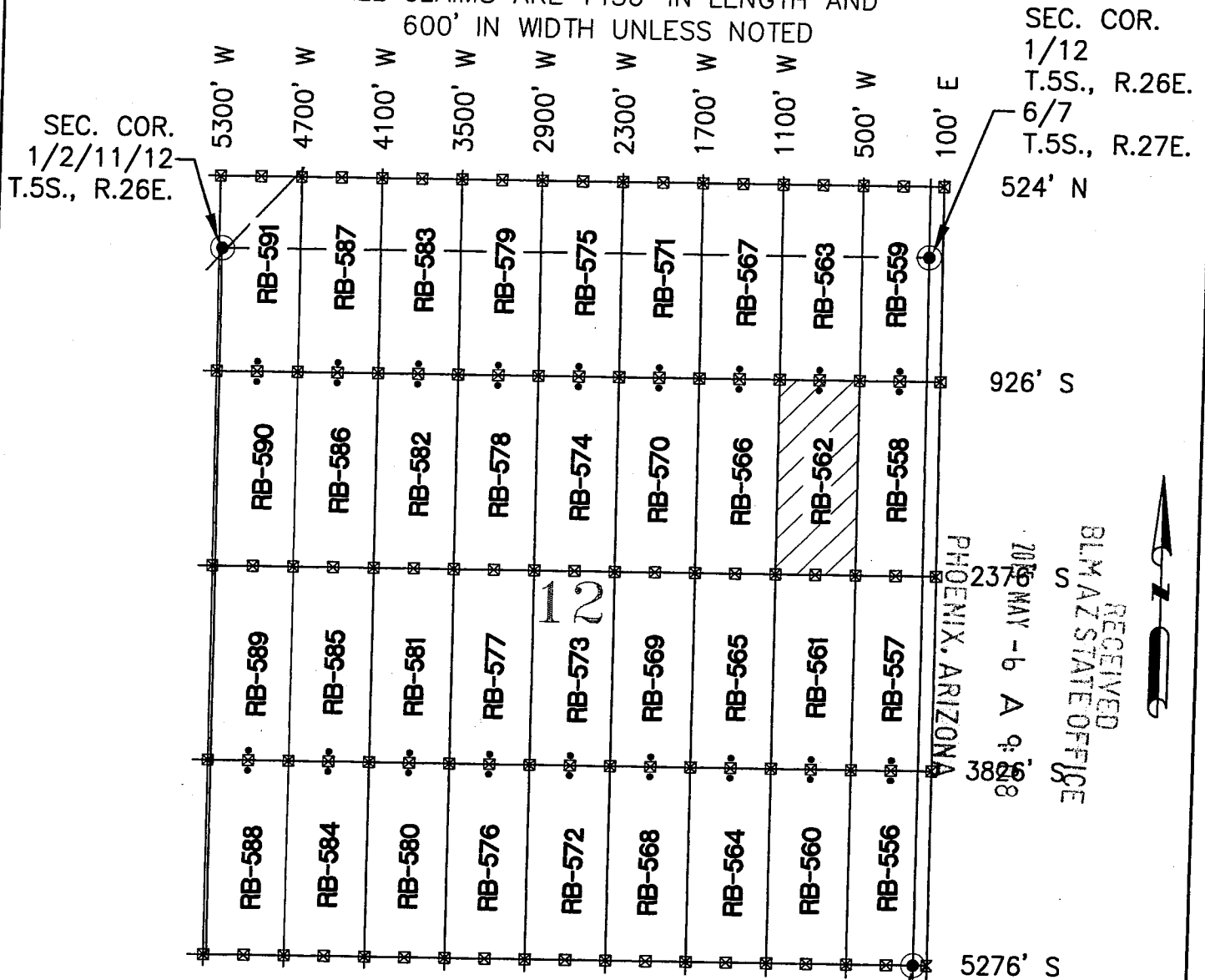

- ☒ INDICATES CORNER OF LODE CLAIM. SET 2"x2"x5' WOODEN POST (TYPICAL)
- INDICATES LOCATION MONUMENT. SET 2"x2"x5' WOODEN POST WITH SIGN (TYPICAL)

CLAIM ACREAGE = 20.0 AC

WC = WITNESS CORNER NORTH OF SIDE LINE

LOCATORS:  
FREEPORT MINERALS CORP.  
PO BOX 1019  
SAFFORD AZ 85548



**Entellus™**  
2255 N. 44th Street Suite 125  
Phoenix, AZ 85008.3279  
Tel 602.244.2566  
Fax 602.244.8947  
Website: www.Entellus.com

RECEIVED  
BLM AZ STATE OFFICE  
2015 MAY - 6 A 9: 38  
PHOENIX, ARIZONA  
2376 S  
3826 S

SEC. COR.  
12/13 T.5S., R.26E.  
7/18 T.5S., R.27E.

**LOCATION NOTICE FOR LODE MINING CLAIM**

Amendment      BLM Serial # \_\_\_\_\_

NOTICE IS HEREBY GIVEN that the Red Bull - 563

\_\_\_\_\_ lode mining claim has been located

by Freeport Minerals Corporation whose current mailing

address is P.O. Box 1019

Safford, Arizona 85548

The general course of this claim is North to South and it is situated in \_\_\_\_\_ Graham

County, Arizona. This claim is 1450 feet in length and 600 feet in width.

20.0 Total Claim Acreage. This claim runs from the location monument on which this location notice

is posted on the centerline of the claim approximately 10 feet in a Southerly direction to the South

end line and 1440 feet in a Northerly direction to the North end line. This claim is marked by six

monuments, one at each corner and one at the center of each end line of the claim.

The location monument on which this notice is posted is situated within Section 12 Township 5

S, Range 26 E, Gila Salt River Base and Meridian, Arizona and this claim encompasses portions

of the following quarter section(s), section(s), Township(s) and Range(s) NE 1/4

Section 12 Township 5S Range 26E SE 1/4 Section 1 Township 5S Range 26E

Gila Salt River Base and Meridian, Arizona.

The locality of this claim with reference to some natural object or permanent monument and additional information

(if any) concerning its locality are as follows: The Northeast corner of the claim is 524' North and 500' West of the monument at the

Northeast Corner of Section 12, Township 5S, Range 26E

The above information is shown on the attached map.

DATED AND POSTED on the ground this 15 day of April, 2015.

LOCATOR(s)       AGENT

Print Name(s) Entellus, Inc. - Daniel G. Francetic, RLS

Signature(s) *Daniel G. Francetic*

RECEIVED  
BLM AZ STATE OFFICE  
2015 MAY -6 A 9:08  
PHOENIX, ARIZONA  
BLM  
Date  
Stamp

Form MCF100  
Revised July 2014

This form is available from the Arizona Geological Survey and may be reproduced.

AMC4322071

# RED BULL - 563 CLAIM

LOCATION **U** RED BULL-556 THROUGH RED BULL-591 LODE CLAIMS

LOCATED IN SECTIONS 1, 2, 11, 12, T.5S., R.26E. AND SECTIONS 6, & 7, T.5S., R.27E.  
GRAHAM COUNTY, ARIZONA

ALL CLAIMS ARE 1450' IN LENGTH AND  
600' IN WIDTH UNLESS NOTED

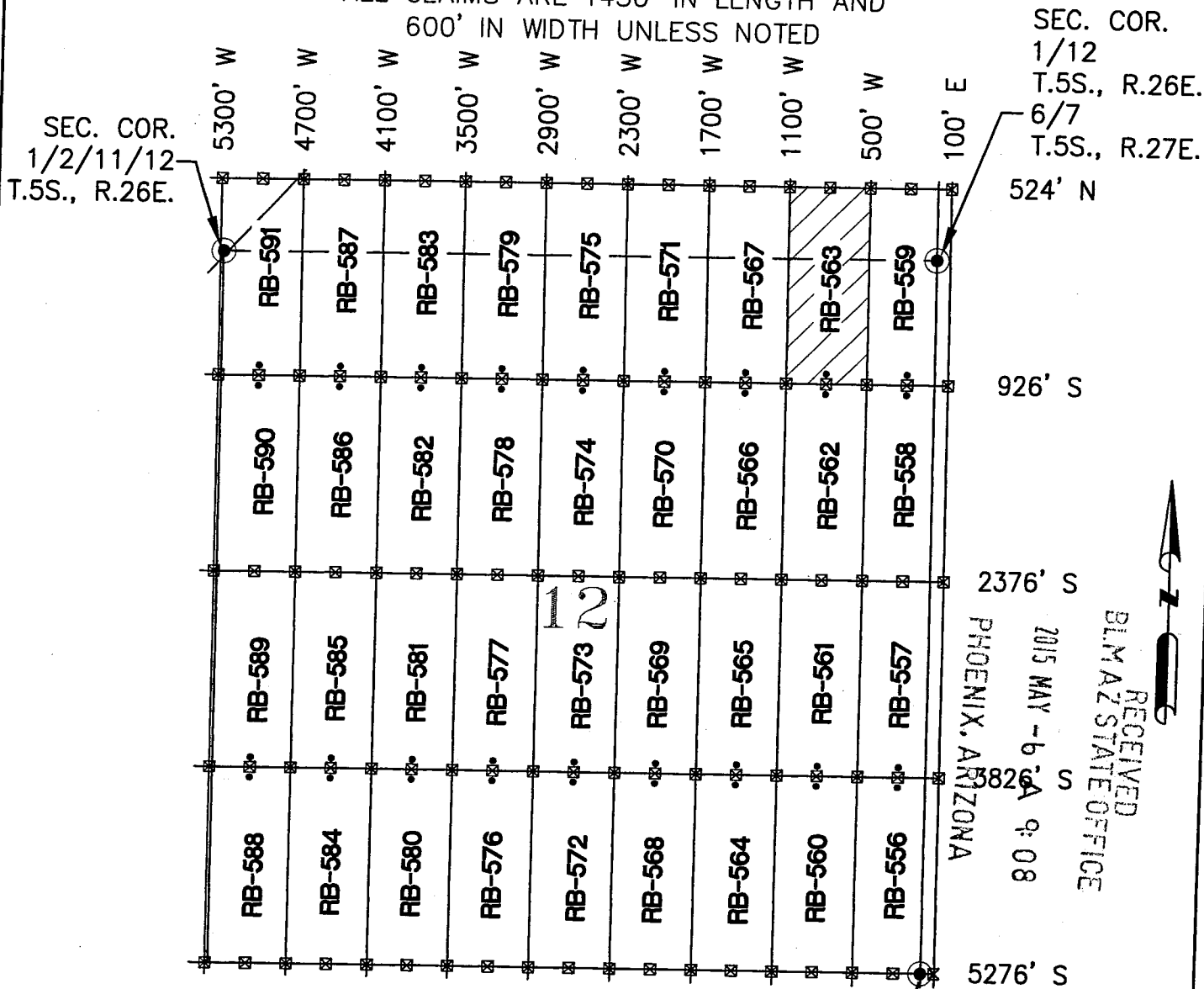

RECEIVED  
BLM AZ STATE OFFICE  
2015 MAY - 6 AM 9:08  
PHOENIX, ARIZONA

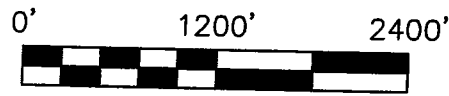
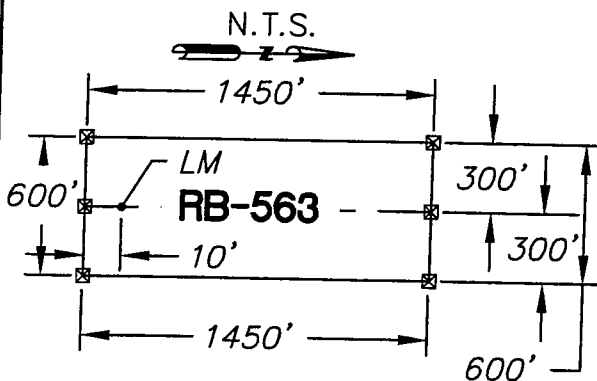

- ☒ INDICATES CORNER OF LODE CLAIM. SET 2"x2"x5' WOODEN POST (TYPICAL)
- INDICATES LOCATION MONUMENT. SET 2"x2"x5' WOODEN POST WITH SIGN (TYPICAL)

LOCATORS:  
FREEPORT MINERALS CORP.  
PO BOX 1019  
SAFFORD AZ 85548

CLAIM ACREAGE = 20.0 AC  
WC = WITNESS CORNER NORTH  
OF SIDE LINE

**Entellus™**  
2255 N. 44th Street Suite 125  
Phoenix, AZ 85008.3279  
Tel 602.244.2566  
Fax 602.244.8947  
Website: www.Entellus.com

**LOCATION NOTICE FOR LODE MINING CLAIM**

Amendment BLM Serial # \_\_\_\_\_

NOTICE IS HEREBY GIVEN that the Red Bull - 564

\_\_\_\_\_ lode mining claim has been located

by Freeport Minerals Corporation whose current mailing

address is P.O. Box 1019

Safford, Arizona 85548

The general course of this claim is North to South and it is situated in \_\_\_\_\_

County, Arizona. This claim is 1450 feet in length and 600 feet in width.

20.0 Total Claim Acreage. This claim runs from the location monument on which this location notice

is posted on the centerline of the claim approximately 10 feet in a Northerly direction to the North

end line and 1440 feet in a Southerly direction to the South end line. This claim is marked by six

monuments, one at each corner and one at the center of each end line of the claim.

The location monument on which this notice is posted is situated within Section 12 Township 5

S, Range 26 E, Gila Salt River Base and Meridian, Arizona and this claim encompasses portions

of the following quarter section(s), section(s), Township(s) and Range(s) SE 1/4

Section 12 Township 5S Range 26E

Gila Salt River Base and Meridian, Arizona.

The locality of this claim with reference to some natural object or permanent monument and additional information

(if any) concerning its locality are as follows: The Northeast corner of the claim is 3826' South and 1100' West of the monument at the

Northeast Corner of Section 12, Township 5S, Range 26E

The above information is shown on the attached map.

DATED AND POSTED on the ground this 14 day of April, 2015.

LOCATOR(s)  AGENT

Print Name(s) Entellus, Inc. - Daniel G. Francetic, RLS

Signature(s) *Daniel G. Francetic*

RECEIVED  
BLM AZ STATE OFFICE  
2015 MAY -6 A 9:08  
PHOENIX, ARIZONA  
BLM  
Date  
Stamp  
Graham

AMC432208

Form MCF100  
Revised July 2014

This form is available from the Arizona Geological Survey and may be reproduced.

# RED BULL - 564 CLAIM

LOCATION OF RED BULL-556 THROUGH RED BULL-591 LODE CLAIMS

LOCATED IN SECTIONS 1, 2, 11, 12, T.5S., R.26E. AND SECTIONS 6, & 7, T.5S., R.27E. GRAHAM COUNTY, ARIZONA

ALL CLAIMS ARE 1450' IN LENGTH AND 600' IN WIDTH UNLESS NOTED

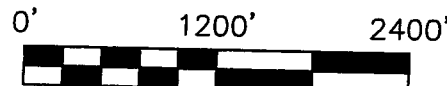
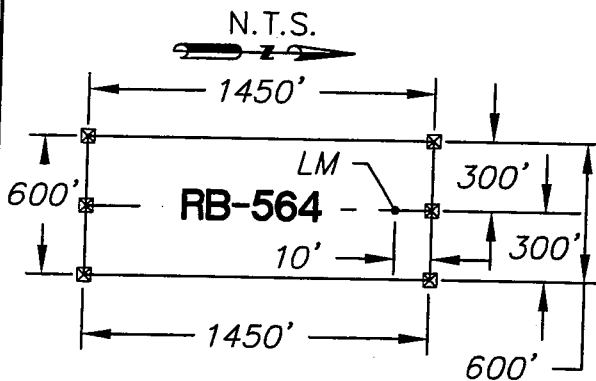
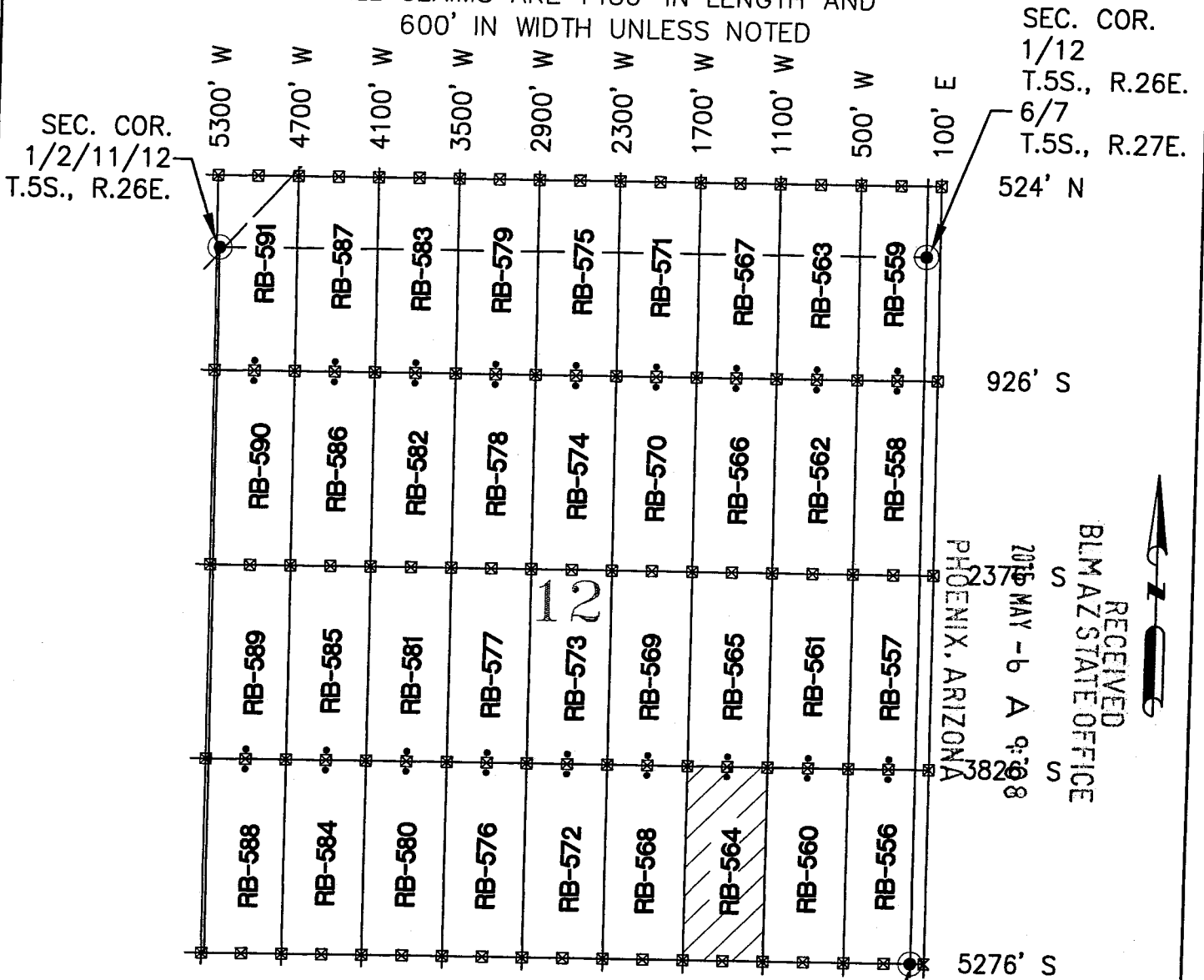

- ☒ INDICATES CORNER OF LODE CLAIM. SET 2"x2"x5' WOODEN POST (TYPICAL)
- INDICATES LOCATION MONUMENT. SET 2"x2"x5' WOODEN POST WITH SIGN (TYPICAL)

LOCATORS:  
FREEPORT MINERALS CORP.  
PO BOX 1019  
SAFFORD AZ 85548

CLAIM ACREAGE = 20.0 AC  
WC = WITNESS CORNER NORTH OF SIDE LINE

**Entellus™**  
2255 N. 44th Street Suite 125  
Phoenix, AZ 85008.3279  
Tel 602.244.2566  
Fax 602.244.8947  
Website: www.Entellus.com

**LOCATION NOTICE FOR LODE MINING CLAIM**

Amendment BLM Serial # \_\_\_\_\_

NOTICE IS HEREBY GIVEN that the Red Bull - 565

\_\_\_\_\_ lode mining claim has been located

by Freeport Minerals Corporation whose current mailing

address is P.O. Box 1019

Safford, Arizona 85548

The general course of this claim is North to South and it is situated in Graham

County, Arizona. This claim is 1450 feet in length and 600 feet in width.

20.0 Total Claim Acreage. This claim runs from the location monument on which this location notice

is posted on the centerline of the claim approximately 10 feet in a Southerly direction to the South

end line and 1440 feet in a Northerly direction to the North end line. This claim is marked by six monuments, one at each corner and one at the center of each end line of the claim.

The location monument on which this notice is posted is situated within Section 12 Township 5

S, Range 26 E, Gila Salt River Base and Meridian, Arizona and this claim encompasses portions

of the following quarter section(s), section(s), Township(s) and Range(s) SE 1/4 NE 1/4

Section 12 Township 5S Range 26E

Gila Salt River Base and Meridian, Arizona.

The locality of this claim with reference to some natural object or permanent monument and additional information (if any) concerning its locality are as follows: The Northeast corner of the claim is 2376' South and 1100' West of the monument at the Northeast Corner of Section 12, Township 5S, Range 26E

The above information is shown on the attached map.

DATED AND POSTED on the ground this 14 day of April, 2015

LOCATOR(s)  AGENT

Print Name(s) Entellus, Inc. - Daniel G. Francetic, RLS

Signature(s) *Daniel G. Francetic*

RECEIVED  
BLM AZ STATE OFFICE  
2015 MAY -6 A 9:08  
PHOENIX, ARIZONA

BLM  
Date  
Stamp

AMC432209

Form MCF100  
Revised July 2014

# RED BULL - 565 CLAIM

## LOCATION OF RED BULL-556 THROUGH RED BULL-591 LODE CLAIMS

LOCATED IN SECTIONS 1, 2, 11, 12, T.5S., R.26E. AND SECTIONS 6, & 7, T.5S., R.27E.  
GRAHAM COUNTY, ARIZONA

ALL CLAIMS ARE 1450' IN LENGTH AND  
600' IN WIDTH UNLESS NOTED

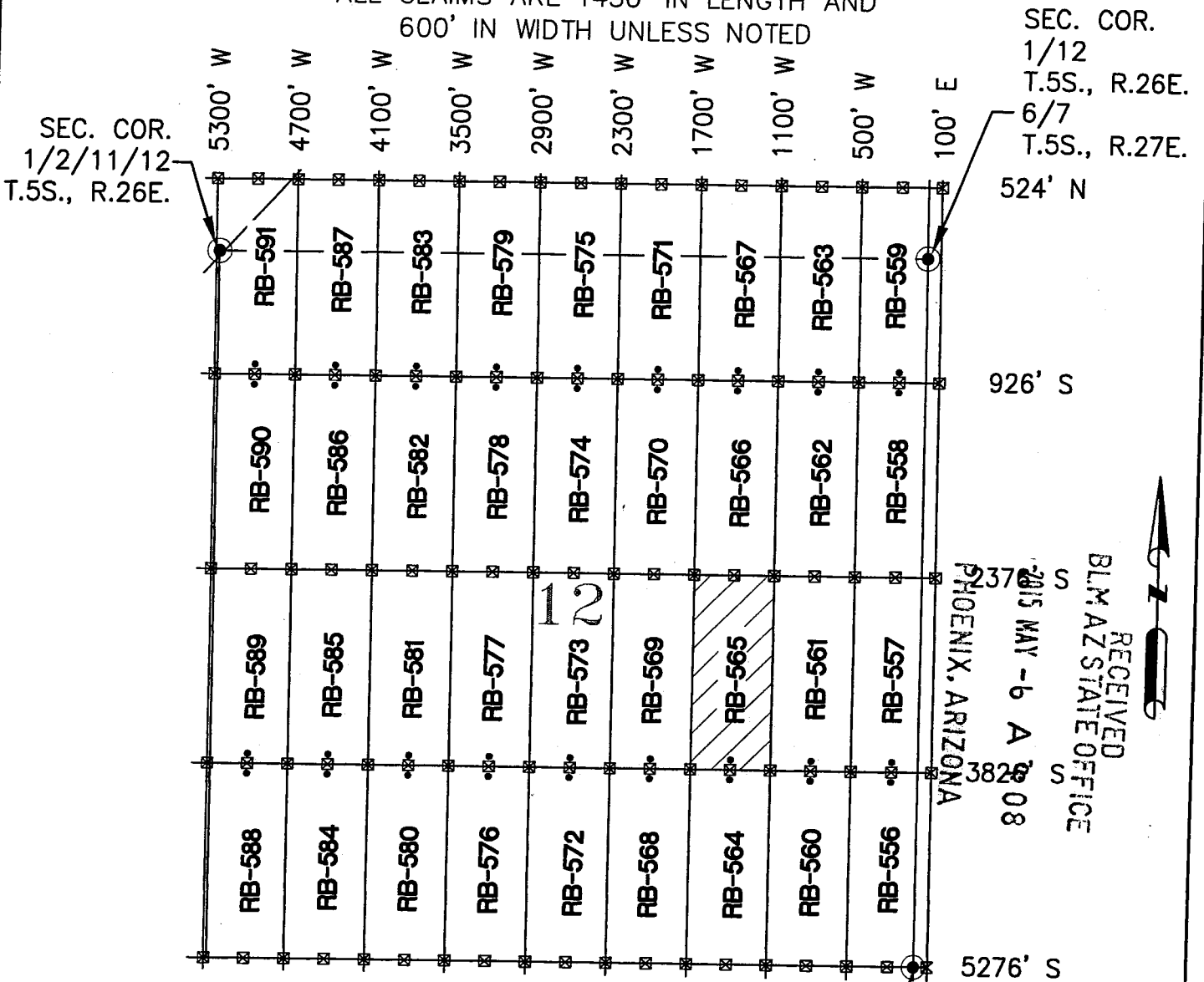

RECEIVED  
BLM AZ STATE OFFICE  
PHOENIX, ARIZONA  
MAY 9 2015  
8 08



N.T.S.

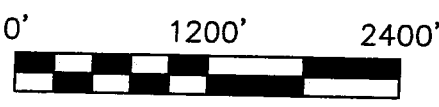
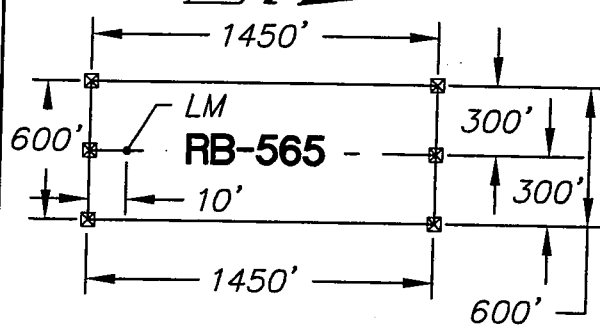

- ☒ INDICATES CORNER OF LODE CLAIM. SET 2"x2"x5' WOODEN POST (TYPICAL)
- INDICATES LOCATION MONUMENT. SET 2"x2"x5' WOODEN POST WITH SIGN (TYPICAL)

LOCATORS:  
FREEPORT MINERALS CORP.  
PO BOX 1019  
SAFFORD AZ 85548

CLAIM ACREAGE = 20.0 AC  
WC = WITNESS CORNER NORTH  
OF SIDE LINE

**Entellus™**  
2255 N. 44th Street Suite 125  
Phoenix, AZ 85008.3279  
Tel 602.244.2566  
Fax 602.244.8947  
Website: www.Entellus.com

**LOCATION NOTICE FOR LODE MINING CLAIM**

Amendment BLM Serial # \_\_\_\_\_

NOTICE IS HEREBY GIVEN that the Red Bull - 566

\_\_\_\_\_ lode mining claim has been located

by Freeport Minerals Corporation whose current mailing

address is P.O. Box 1019

Safford, Arizona 85548

RECEIVED  
BLM AZ STATE OFFICE  
2015 MAY -6 A 9:08  
PHOENIX, ARIZONA  
BLM  
Date  
Stamp

The general course of this claim is North to South and it is situated in Graham

County, Arizona. This claim is 1450 feet in length and 600 feet in width.

20.0 Total Claim Acreage. This claim runs from the location monument on which this location notice

is posted on the centerline of the claim approximately 10 feet in a Northerly direction to the North

end line and 1440 feet in a Southerly direction to the South end line. This claim is marked by six

monuments, one at each corner and one at the center of each end line of the claim.

The location monument on which this notice is posted is situated within Section 12 Township 5

S, Range 26 E, Gila Salt River Base and Meridian, Arizona and this claim encompasses portions

of the following quarter section(s), section(s), Township(s) and Range(s) NE 1/4

Section 12 Township 5S Range 26E

Gila Salt River Base and Meridian, Arizona.

The locality of this claim with reference to some natural object or permanent monument and additional information

(if any) concerning its locality are as follows: The Northeast corner of the claim is 926' South and 1100' West of the monument at the

Northeast Corner of Section 12, Township 5S, Range 26E

The above information is shown on the attached map.

DATED AND POSTED on the ground this 15 day of April, 2015.

LOCATOR(s)  AGENT

Print Name(s) Entellus, Inc. - Daniel G. Francetic, RLS

Signature(s) *Daniel G. Francetic*

AMC 432210

Form MCF100  
Revised July 2014



# RED BULL - 566 CLAIM

## LOCATION OF RED BULL-556 THROUGH RED BULL-591 LODE CLAIMS

LOCATED IN SECTIONS 1, 2, 11, 12, T.5S., R.26E. AND SECTIONS 6, & 7, T.5S., R.27E.  
GRAHAM COUNTY, ARIZONA

ALL CLAIMS ARE 1450' IN LENGTH AND  
600' IN WIDTH UNLESS NOTED

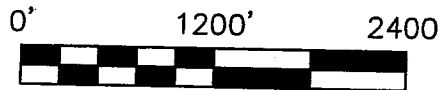
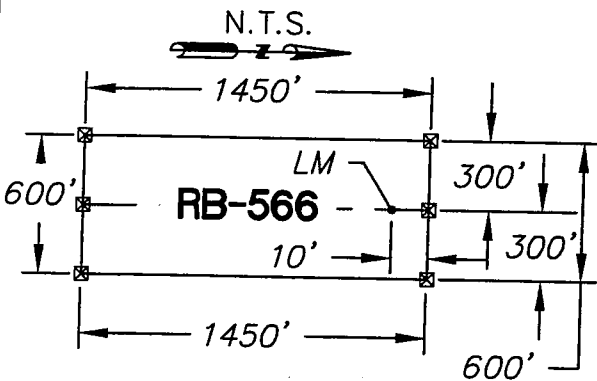
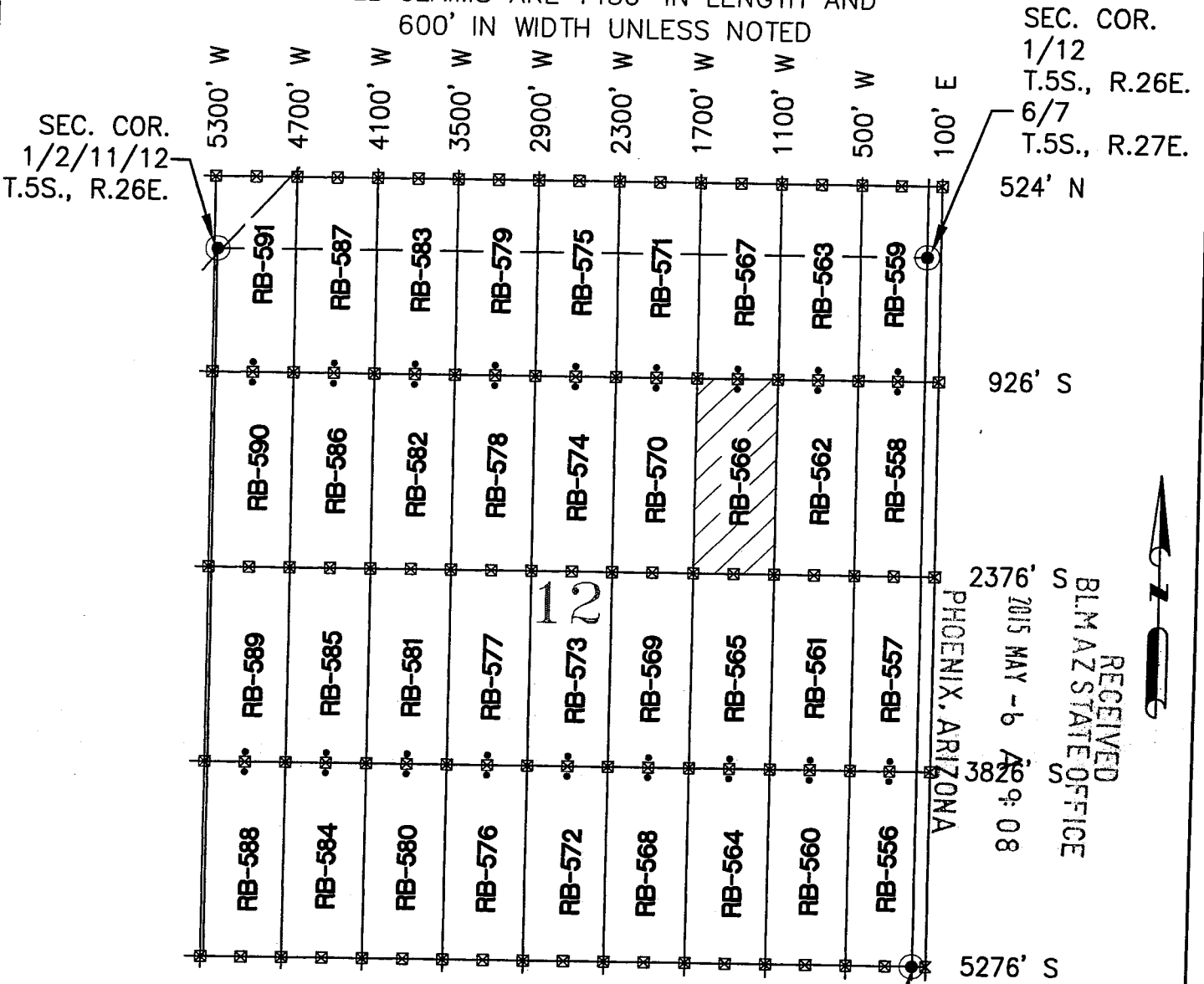

- ☒ INDICATES CORNER OF LODE CLAIM. SET 2"x2"x5' WOODEN POST (TYPICAL)
- INDICATES LOCATION MONUMENT. SET 2"x2"x5' WOODEN POST WITH SIGN (TYPICAL)

LOCATORS:  
FREEMPORT MINERALS CORP.  
PO BOX 1019  
SAFFORD AZ 85548

CLAIM ACREAGE = 20.0 AC  
WC = WITNESS CORNER NORTH  
OF SIDE LINE

**Entellus**<sup>™</sup>  
2255 N. 44th Street Suite 125  
Phoenix, AZ 85008.3279  
Tel 602.244.2566  
Fax 602.244.8947  
Website: www.Entellus.com

**LOCATION NOTICE FOR LODE MINING CLAIM**

Amendment      BLM Serial # \_\_\_\_\_

NOTICE IS HEREBY GIVEN that the Red Bull - 567

\_\_\_\_\_ lode mining claim has been located

by Freeport Minerals Corporation whose current mailing

address is P.O. Box 1019

Safford, Arizona 85548

The general course of this claim is North to South and it is situated in \_\_\_\_\_

County, Arizona. This claim is 1450 feet in length and 600 feet in width.

20.0 Total Claim Acreage. This claim runs from the location monument on which this location notice is posted on the centerline of the claim approximately 10 feet in a Southerly direction to the South end line and 1440 feet in a Northerly direction to the North end line. This claim is marked by six

monuments, one at each corner and one at the center of each end line of the claim.

The location monument on which this notice is posted is situated within Section 12 Township 5

S, Range 26 E, Gila Salt River Base and Meridian, Arizona and this claim encompasses portions of the following quarter section(s), section(s), Township(s) and Range(s) NE 1/4

Section 12 Township 5S Range 26E SE 1/4 Section 1 Township 5S Range 26E

Gila Salt River Base and Meridian, Arizona.

The locality of this claim with reference to some natural object or permanent monument and additional information

(if any) concerning its locality are as follows: The Northeast corner of the claim is 524' North and 1100' West of the monument at the Northeast Corner of Section 12, Township 5S, Range 26E

The above information is shown on the attached map.

DATED AND POSTED on the ground this 15 day of April, 2015.

LOCATOR(s)       AGENT

Print Name(s) Entellus, Inc. - Daniel G. Francetic, RLS

Signature(s) *Daniel G. Francetic*

RECEIVED  
BLM AZ STATE OFFICE  
2015 MAY -6 A 9:08  
PHOENIX, ARIZONA  
BLM Date Stamp  
Graham

AMC 4322111

Form MCF100  
Revised July 2014

This form is available from the Arizona Geological Survey and may be reproduced.

# RED BULL - 567 CLAIM

## LOCATION OF RED BULL-556 THROUGH RED BULL-591 LODE CLAIMS

LOCATED IN SECTIONS 1, 2, 11, 12, T.5S., R.26E. AND SECTIONS 6, & 7, T.5S., R.27E.  
GRAHAM COUNTY, ARIZONA

ALL CLAIMS ARE 1450' IN LENGTH AND  
600' IN WIDTH UNLESS NOTED

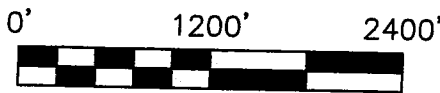
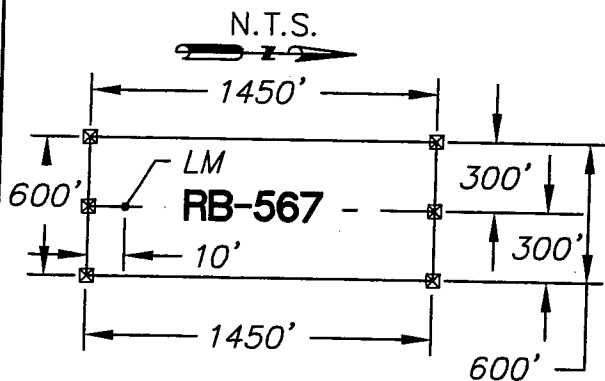
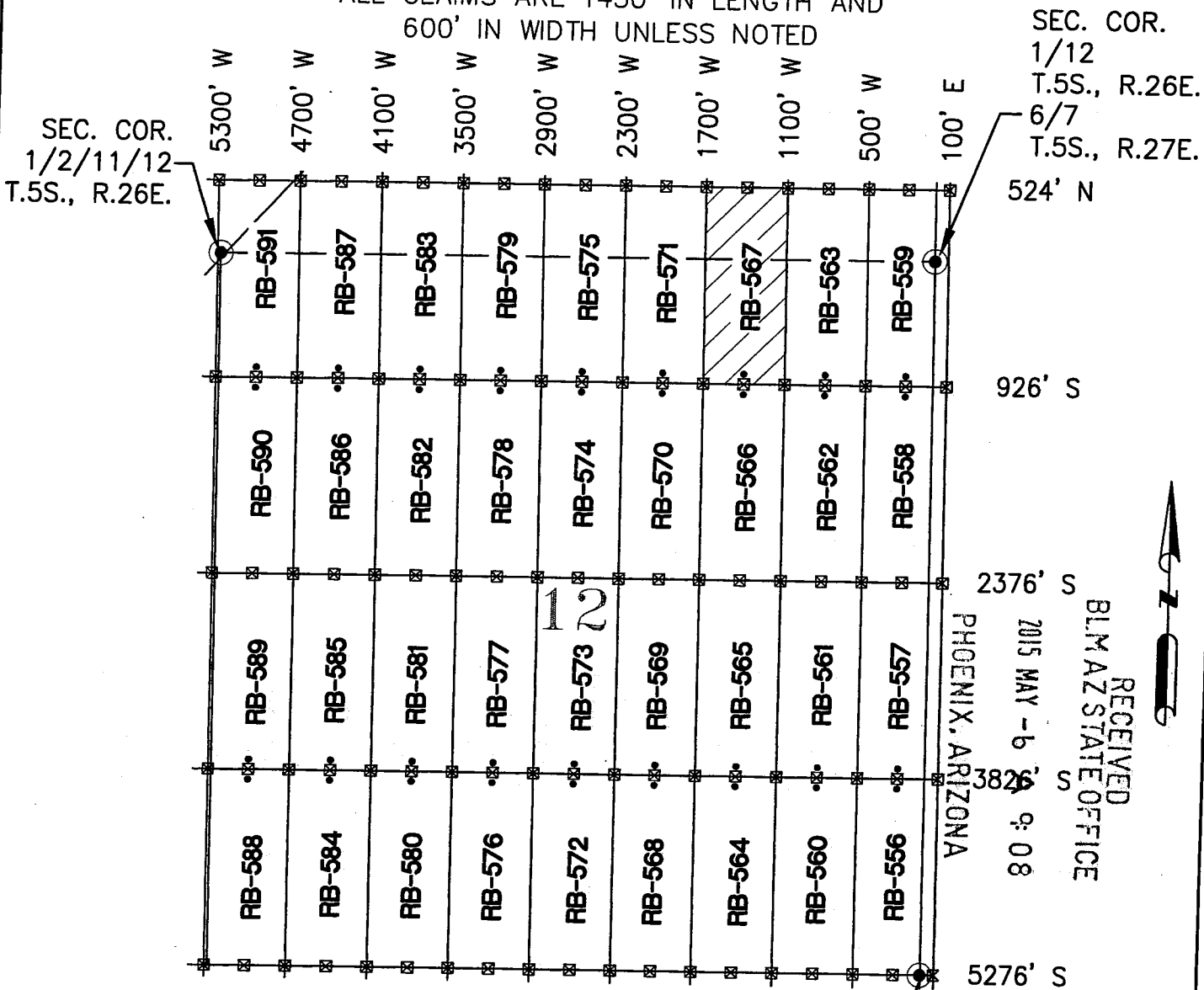

- ☒ INDICATES CORNER OF LODE CLAIM. SET 2"x2"x5' WOODEN POST (TYPICAL)
- INDICATES LOCATION MONUMENT. SET 2"x2"x5' WOODEN POST WITH SIGN (TYPICAL)

LOCATORS:  
FREEPORT MINERALS CORP.  
PO BOX 1019  
SAFFORD AZ 85548

CLAIM ACREAGE = 20.0 AC  
WC = WITNESS CORNER NORTH  
OF SIDE LINE

 **Entellus**  
2255 N. 44th Street Suite 125  
Phoenix, AZ 85008.3279  
Tel 602.244.2566  
Fax 602.244.8947  
Website: www.Entellus.com

LOCATION NOTICE FOR LODE MINING CLAIM

Amendment BLM Serial # \_\_\_\_\_

NOTICE IS HEREBY GIVEN that the Red Bull - 568

\_\_\_\_\_ lode mining claim has been located

by Freeport Minerals Corporation whose current mailing

address is P.O. Box 1019

Safford, Arizona 85548

RECEIVED  
BLM AZ STATE OFFICE  
2015 MAY -6 A 9:08  
PHOENIX, ARIZONA  
BLM  
Date  
Stamp

The general course of this claim is North to South and it is situated in Graham

County, Arizona. This claim is 1450 feet in length and 600 feet in width.

20.0 Total Claim Acreage. This claim runs from the location monument on which this location notice

is posted on the centerline of the claim approximately 10 feet in a Northerly direction to the North

end line and 1440 feet in a Southerly direction to the South end line. This claim is marked by six  
monuments, one at each corner and one at the center of each end line of the claim.

The location monument on which this notice is posted is situated within Section 12 Township 5

S, Range 26 E, Gila Salt River Base and Meridian, Arizona and this claim encompasses portions

of the following quarter section(s), section(s), Township(s) and Range(s) SE 1/4

Section 12 Township 5S Range 26E

Gila Salt River Base and Meridian, Arizona.

The locality of this claim with reference to some natural object or permanent monument and additional information

(if any) concerning its locality are as follows: The Northeast corner of the claim is 3826' South and 1700' West of the monument at the  
Northeast Corner of Section 12, Township 5S, Range 26E

The above information is shown on the attached map.

DATED AND POSTED on the ground this 14 day of April, 2015

LOCATOR(s)  AGENT

Print Name(s) Entellus, Inc. - Daniel G. Francetic, RLS

Signature(s) [Signature]

Form MCF100  
Revised July 2014

This form is available from the Arizona Geological Survey and may be reproduced.

AMC4322121

# RED BULL - 568 CLAIM

LOCATION OF RED BULL-556 THROUGH RED BULL-591 LODE CLAIMS

LOCATED IN SECTIONS 1, 2, 11, 12, T.5S., R.26E. AND SECTIONS 6, & 7, T.5S., R.27E.  
GRAHAM COUNTY, ARIZONA

ALL CLAIMS ARE 1450' IN LENGTH AND  
600' IN WIDTH UNLESS NOTED

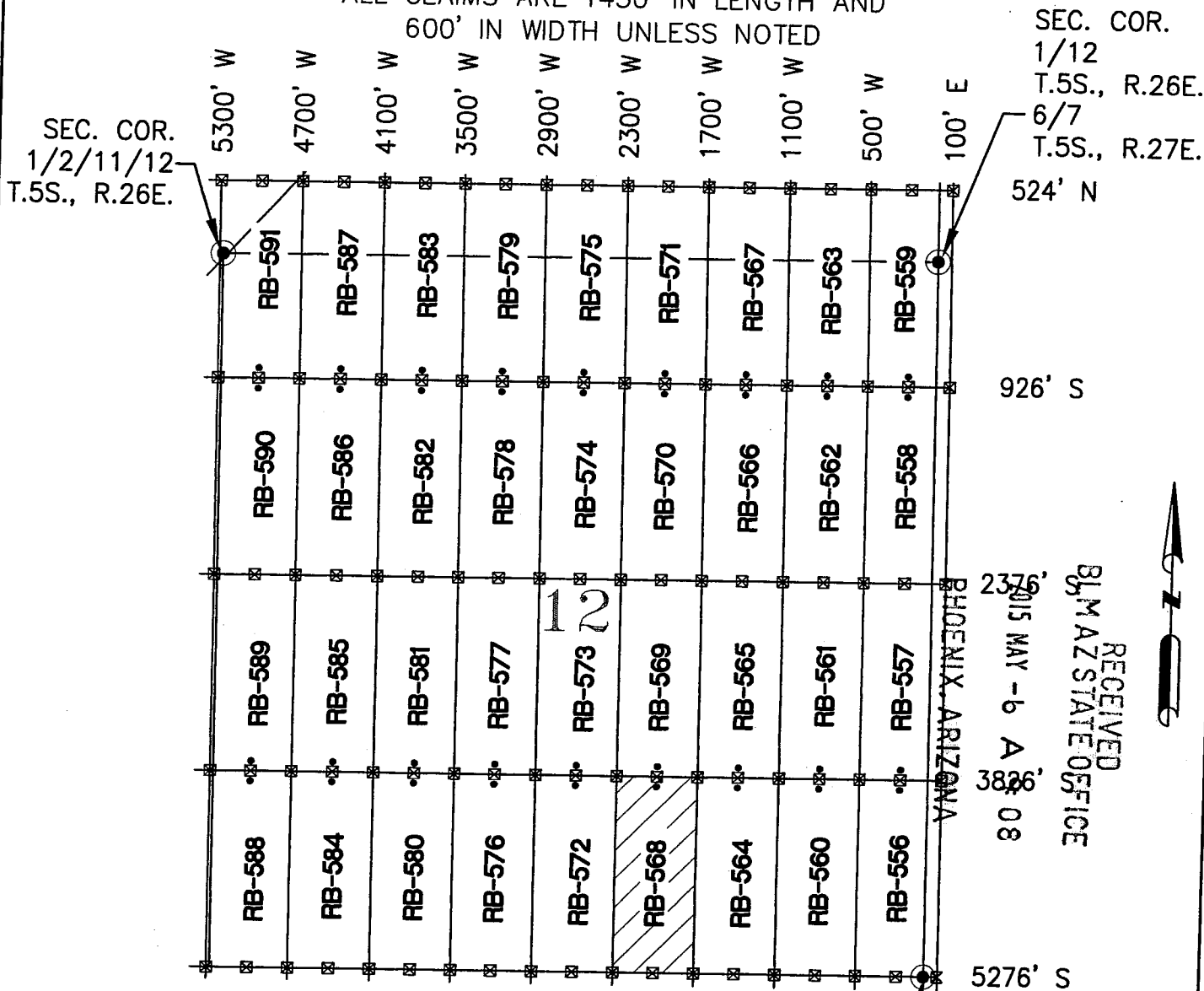

N.T.S.

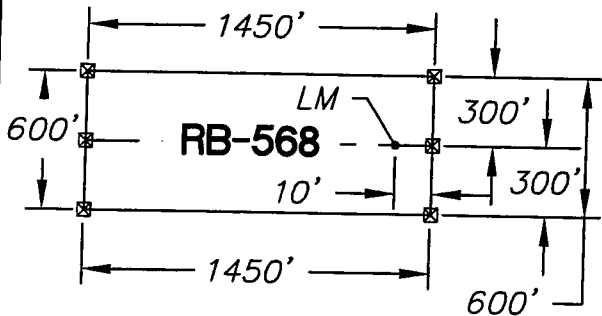

0' 1200' 2400'



- ☒ INDICATES CORNER OF LODE CLAIM. SET 2"x2"x5' WOODEN POST (TYPICAL)
- INDICATES LOCATION MONUMENT. SET 2"x2"x5' WOODEN POST WITH SIGN (TYPICAL)

LOCATORS:  
FREEPORT MINERALS CORP.  
PO BOX 1019  
SAFFORD AZ 85548

CLAIM ACREAGE = 20.0 AC  
WC = WITNESS CORNER NORTH  
OF SIDE LINE

 **Entellus™**  
2255 N. 44th Street Suite 125  
Phoenix, AZ 85008.9279  
Tel 602.244.2566  
Fax 602.244.8947  
Website: www.Entellus.com

**LOCATION NOTICE FOR LODE MINING CLAIM**

Amendment BLM Serial # \_\_\_\_\_

NOTICE IS HEREBY GIVEN that the Red Bull - 569

\_\_\_\_\_ lode mining claim has been located

by Freeport Minerals Corporation whose current mailing

address is P.O. Box 1019

Safford, Arizona 85548

The general course of this claim is North to South and it is situated in \_\_\_\_\_

County, Arizona. This claim is 1450 feet in length and 600 feet in width.

20.0 Total Claim Acreage. This claim runs from the location monument on which this location notice

is posted on the centerline of the claim approximately 10 feet in a Southerly direction to the South

end line and 1440 feet in a Northerly direction to the North end line. This claim is marked by six monuments, one at each corner and one at the center of each end line of the claim.

The location monument on which this notice is posted is situated within Section 12 Township 5

S, Range 26 E, Gila Salt River Base and Meridian, Arizona and this claim encompasses portions

of the following quarter section(s), section(s), Township(s) and Range(s) SE 1/4 NE 1/4

Section 12 Township 5S Range 26E

Gila Salt River Base and Meridian, Arizona.

The locality of this claim with reference to some natural object or permanent monument and additional information

(if any) concerning its locality are as follows: The Northeast corner of the claim is 2376' South and 1700' West of the monument at the

Northeast Corner of Section 12, Township 5S, Range 26E

The above information is shown on the attached map.

DATED AND POSTED on the ground this 14 day of April, 2015

LOCATOR(s)  AGENT

Print Name(s) Entellus, Inc. - Daniel G. Francetic, RLS

Signature(s) *Daniel G. Francetic*

RECEIVED  
BLM AZ STATE OFFICE  
2015 MAY - 6 A 9:08  
PHOENIX, ARIZONA  
Graham  
BLM  
Date  
Stamp

AMC432213

# RED BULL - 569 CLAIM

## LOCATION OF RED BULL-556 THROUGH RED BULL-591 LODE CLAIMS

LOCATED IN SECTIONS 1, 2, 11, 12, T.5S., R.26E. AND SECTIONS 6, & 7, T.5S., R.27E.  
GRAHAM COUNTY, ARIZONA

ALL CLAIMS ARE 1450' IN LENGTH AND  
600' IN WIDTH UNLESS NOTED

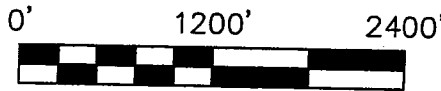
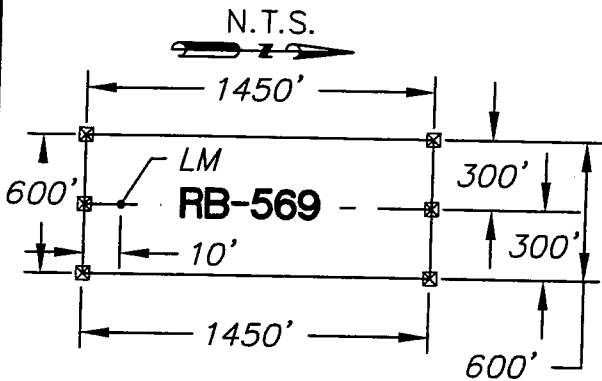
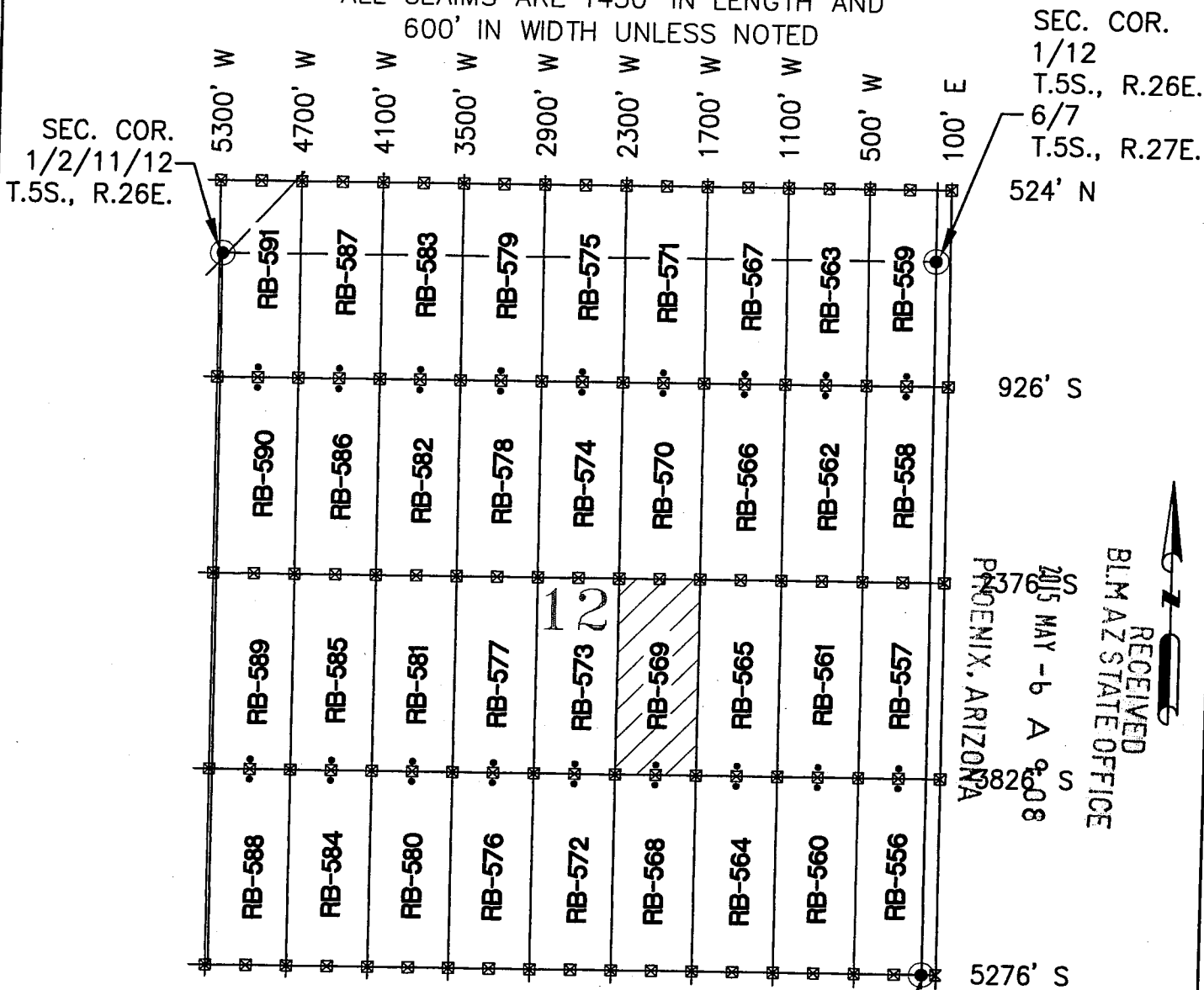

- ☒ INDICATES CORNER OF LODE CLAIM. SET 2"x2"x5' WOODEN POST (TYPICAL)
- INDICATES LOCATION MONUMENT. SET 2"x2"x5' WOODEN POST WITH SIGN (TYPICAL)

LOCATORS:  
FREEPORT MINERALS CORP.  
PO BOX 1019  
SAFFORD AZ 85548

CLAIM ACREAGE = 20.0 AC  
WC = WITNESS CORNER NORTH  
OF SIDE LINE

**Entellus™**  
2255 N. 44th Street Suite 125  
Phoenix, AZ 85008.3279  
Tel 602.244.2566  
Fax 602.244.8947  
Website: www.Entellus.com

**LOCATION NOTICE FOR LODE MINING CLAIM**

Amendment BLM Serial # \_\_\_\_\_

NOTICE IS HEREBY GIVEN that the Red Bull - 570

\_\_\_\_\_ lode mining claim has been located

by Freeport Minerals Corporation whose current mailing

address is P.O. Box 1019

Safford, Arizona 85548

RECEIVED  
BLM AZ STATE OFFICE  
2015 MAY -6 A 9:08  
PHOENIX, ARIZONA  
BLM  
Date  
Stamp

The general course of this claim is North to South and it is situated in Graham

County, Arizona. This claim is 1450 feet in length and 600 feet in width.

20.0 Total Claim Acreage. This claim runs from the location monument on which this location notice

is posted on the centerline of the claim approximately 10 feet in a Northerly direction to the North

end line and 1440 feet in a Southerly direction to the South end line. This claim is marked by six

monuments, one at each corner and one at the center of each end line of the claim.

The location monument on which this notice is posted is situated within Section 12 Township 5

S, Range 26 E, Gila Salt River Base and Meridian, Arizona and this claim encompasses portions

of the following quarter section(s), section(s), Township(s) and Range(s) NE 1/4

Section 12 Township 5S Range 26E

Gila Salt River Base and Meridian, Arizona.

The locality of this claim with reference to some natural object or permanent monument and additional information

(if any) concerning its locality are as follows: The Northeast corner of the claim is 926' South and 1700' West of the monument at the

Northeast Corner of Section 12, Township 5S, Range 26E

The above information is shown on the attached map.

DATED AND POSTED on the ground this 15 day of April, 2015

LOCATOR(s)  AGENT

Print Name(s) Entellus, Inc. - Daniel G. Francetic, RLS

Signature(s) *Daniel G. Francetic*

Form MCF100  
Revised July 2014

This form is available from the Arizona Geological Survey and may be reproduced.

AMC432214



# RED BULL - 570 CLAIM

## LOCATION OF RED BULL-556 THROUGH RED BULL-591 LODE CLAIMS

LOCATED IN SECTIONS 1, 2, 11, 12, T.5S., R.26E. AND SECTIONS 6, & 7, T.5S., R.27E.  
GRAHAM COUNTY, ARIZONA

ALL CLAIMS ARE 1450' IN LENGTH AND  
600' IN WIDTH UNLESS NOTED

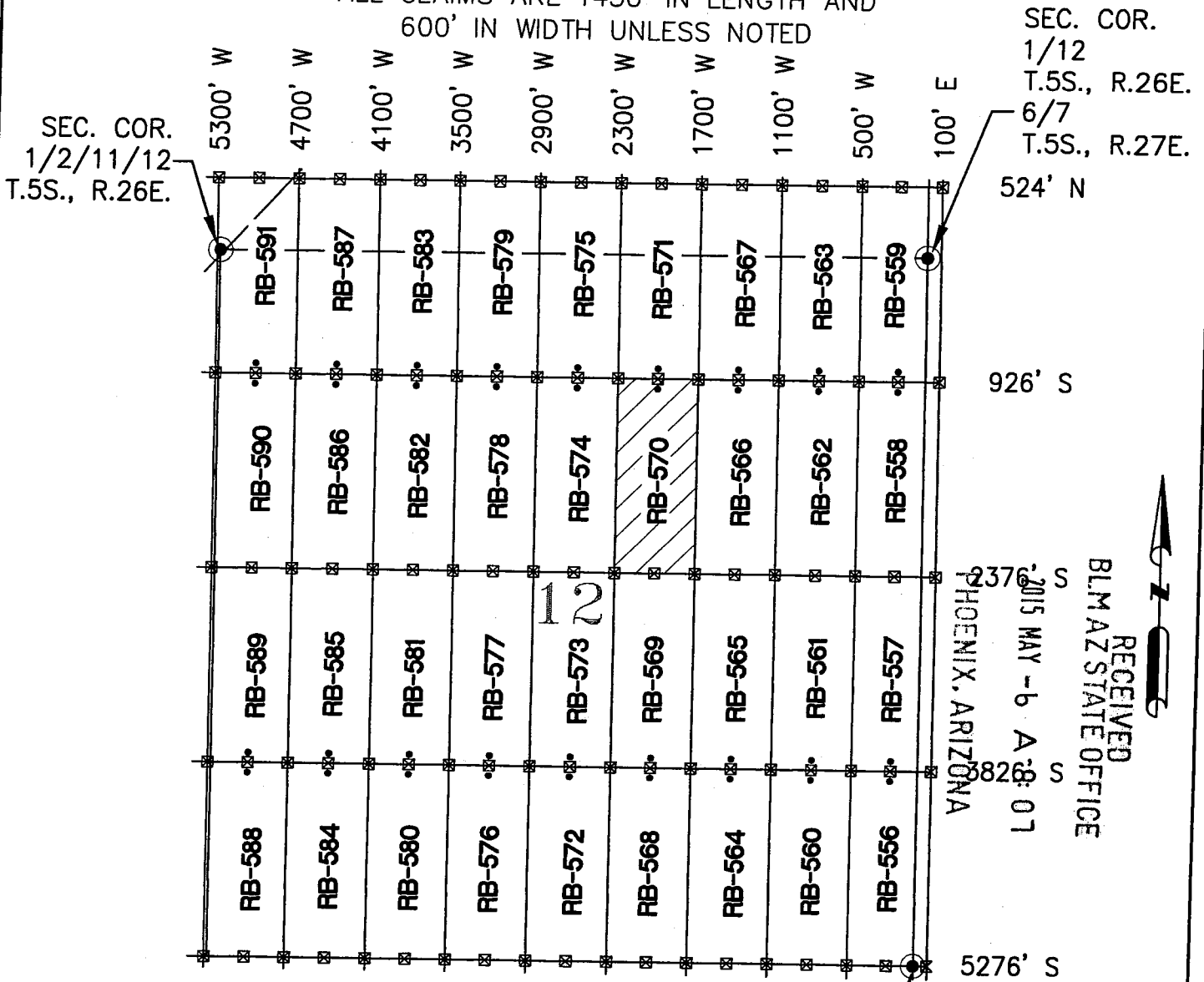

RECEIVED  
BLM AZ STATE OFFICE  
2015 MAY - 6 A 8:01  
PHOENIX, ARIZONA

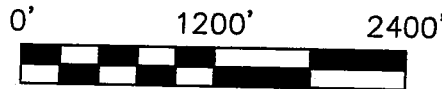
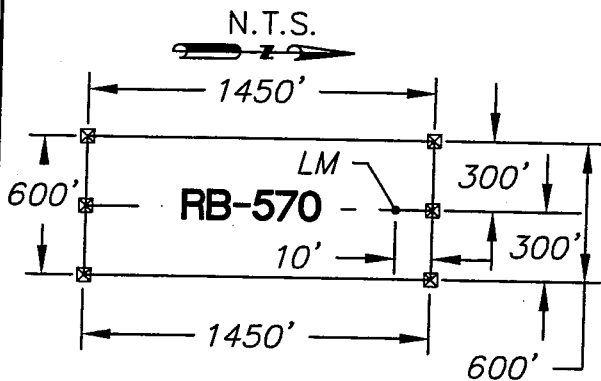

- ☒ INDICATES CORNER OF LODE CLAIM. SET 2"x2"x5' WOODEN POST (TYPICAL)
- INDICATES LOCATION MONUMENT. SET 2"x2"x5' WOODEN POST WITH SIGN (TYPICAL)

LOCATORS:  
FREEPORT MINERALS CORP.  
PO BOX 1019  
SAFFORD AZ 85548

CLAIM ACREAGE = 20.0 AC  
WC = WITNESS CORNER NORTH  
OF SIDE LINE

**Entellus™**  
2255 N. 44th Street Suite 125  
Phoenix, AZ 85008.3279  
Tel 602.244.2566  
Fax 602.244.8947  
Website: www.Entellus.com

**LOCATION NOTICE FOR LODE MINING CLAIM**

Amendment BLM Serial # \_\_\_\_\_

NOTICE IS HEREBY GIVEN that the Red Bull - 571

\_\_\_\_\_ lode mining claim has been located

by Freeport Minerals Corporation whose current mailing

address is P.O. Box 1019

Safford, Arizona 85548

RECEIVED  
BLM AZ STATE OFFICE  
2015 MAY -6 A 9:07  
PHOENIX, ARIZONA  
BLM Date Stamp

The general course of this claim is North to South and it is situated in \_\_\_\_\_  
County, Arizona. This claim is 1450 feet in length and 600 feet in width.

20.0 Total Claim Acreage. This claim runs from the location monument on which this location notice is posted on the centerline of the claim approximately 10 feet in a Southerly direction to the South end line and 1440 feet in a Northerly direction to the North end line. This claim is marked by six monuments, one at each corner and one at the center of each end line of the claim.

The location monument on which this notice is posted is situated within Section 12 Township 5 S, Range 26 E, Gila Salt River Base and Meridian, Arizona and this claim encompasses portions of the following quarter section(s), section(s), Township(s) and Range(s) NE 1/4

Section 12 Township 5S Range 26E SE 1/4 Section 1 Township 5S Range 26E  
Gila Salt River Base and Meridian, Arizona.

The locality of this claim with reference to some natural object or permanent monument and additional information (if any) concerning its locality are as follows: The Northeast corner of the claim is 524' North and 1700' West of the monument at the Northeast Corner of Section 12, Township 5S, Range 26E

The above information is shown on the attached map.

DATED AND POSTED on the ground this 15 day of April, 2015

LOCATOR(s)  AGENT

Print Name(s) Entellus, Inc. - Daniel G. Francetic, RLS

Signature(s) *Daniel G. Francetic*

AMC 432218

# RED BULL - 571 CLAIM

LOCATION OF RED BULL-556 THROUGH RED BULL-591 LODE CLAIMS

LOCATED IN SECTIONS 1, 2, 11, 12, T.5S., R.26E. AND SECTIONS 6, & 7, T.5S., R.27E.  
GRAHAM COUNTY, ARIZONA

ALL CLAIMS ARE 1450' IN LENGTH AND  
600' IN WIDTH UNLESS NOTED

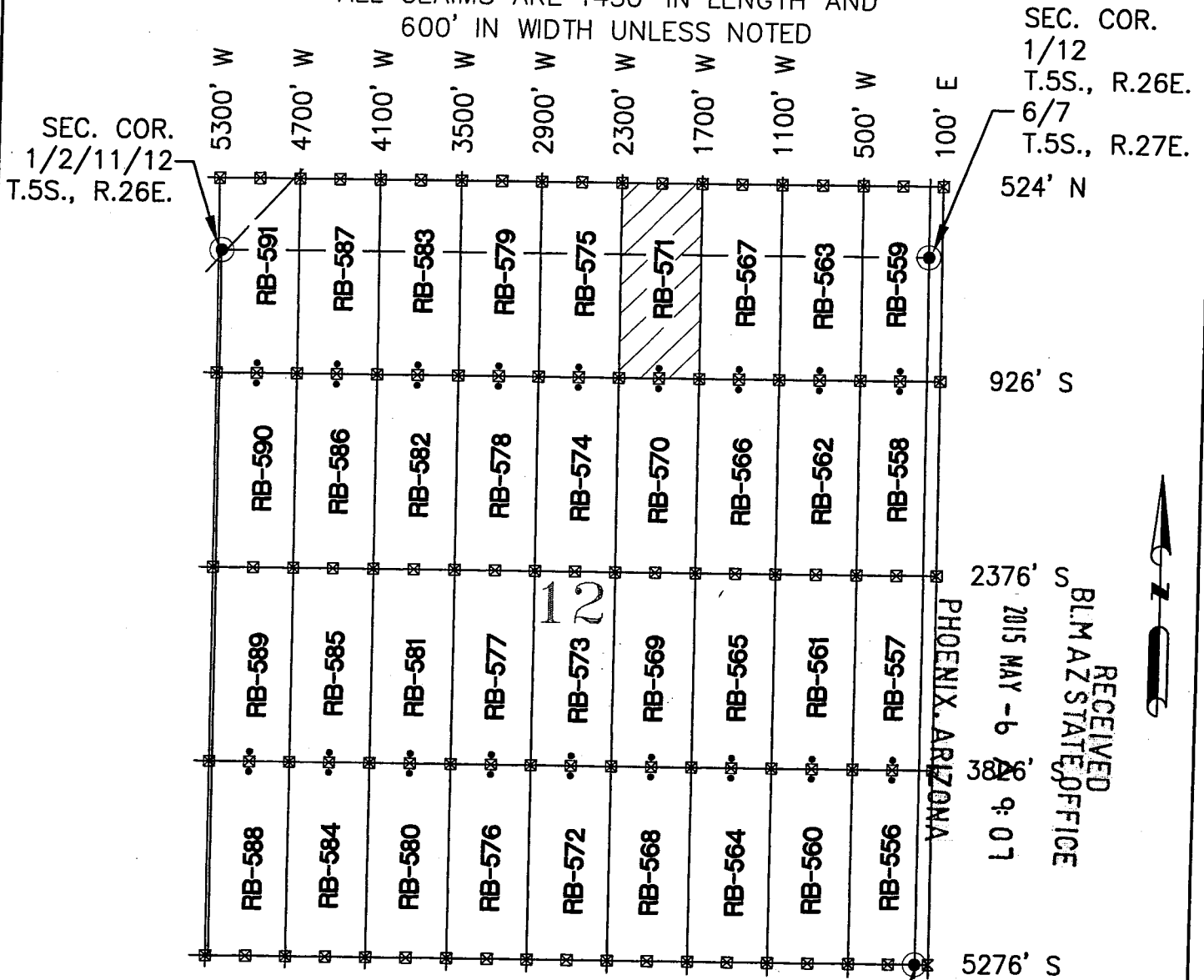

RECEIVED  
BLM AZ STATE OFFICE  
MAY - 6 2015  
3 09:07  
PHOENIX, ARIZONA

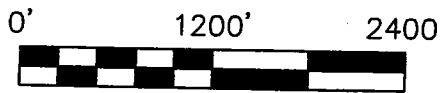
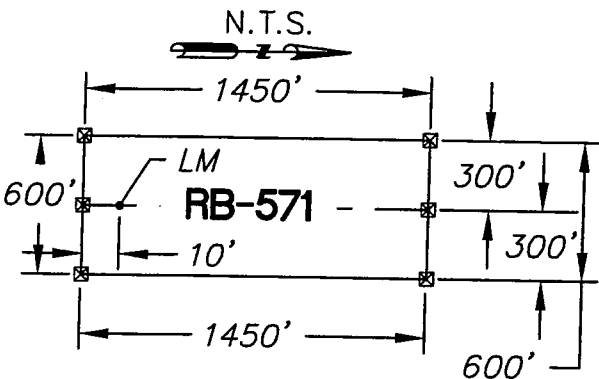

- ⊠ INDICATES CORNER OF LODE CLAIM. SET 2"x2"x5' WOODEN POST (TYPICAL)
- INDICATES LOCATION MONUMENT. SET 2"x2"x5' WOODEN POST WITH SIGN (TYPICAL)

LOCATORS:  
FREEPORT MINERALS CORP.  
PO BOX 1019  
SAFFORD AZ 85548

CLAIM ACREAGE = 20.0 AC  
WC = WITNESS CORNER NORTH  
OF SIDE LINE

 **Entellus™**  
2255 N. 44th Street Suite 125  
Phoenix, AZ 85008.3279  
Tel 602.244.2566  
Fax 602.244.8947  
Website: www.Entellus.com

**LOCATION NOTICE FOR LODE MINING CLAIM**

Amendment BLM Serial # \_\_\_\_\_

NOTICE IS HEREBY GIVEN that the Red Bull - 572

\_\_\_\_\_ lode mining claim has been located

by Freeport Minerals Corporation whose current mailing

address is P.O. Box 1019

Safford, Arizona 85548

The general course of this claim is North to South and it is situated in Graham

County, Arizona. This claim is 1450 feet in length and 600 feet in width.

20.0 Total Claim Acreage. This claim runs from the location monument on which this location notice

is posted on the centerline of the claim approximately 10 feet in a Northerly direction to the North

end line and 1440 feet in a Southerly direction to the South end line. This claim is marked by six

monuments, one at each corner and one at the center of each end line of the claim.

The location monument on which this notice is posted is situated within Section 12 Township 5

S, Range 26 E, Gila Salt River Base and Meridian, Arizona and this claim encompasses portions

of the following quarter section(s), section(s), Township(s) and Range(s) SE 1/4 SW 1/4

Section 12 Township 5S Range 26E

Gila Salt River Base and Meridian, Arizona.

The locality of this claim with reference to some natural object or permanent monument and additional information

(if any) concerning its locality are as follows: The Northeast corner of the claim is 3826' South and 2300' West of the monument at the

Northeast Corner of Section 12, Township 5S, Range 26E

The above information is shown on the attached map.

DATED AND POSTED on the ground this 14 day of April, 2015.

LOCATOR(s)  AGENT

Print Name(s) Entellus, Inc. - Daniel G. Francetic, RLS

Signature(s) *Daniel G. Francetic*

RECEIVED  
BLM AZ STATE OFFICE  
2015 MAY -6 A 9: 01  
PHOENIX, ARIZONA  
BLM  
Date  
Stamp

AMC432216

Form MCF100  
Revised July 2014

# RED BULL - 572 CLAIM

LOCATION OF RED BULL-556 THROUGH RED BULL-591 LODE CLAIMS

LOCATED IN SECTIONS 1, 2, 11, 12, T.5S., R.26E. AND SECTIONS 6, & 7, T.5S., R.27E.  
GRAHAM COUNTY, ARIZONA

ALL CLAIMS ARE 1450' IN LENGTH AND  
600' IN WIDTH UNLESS NOTED

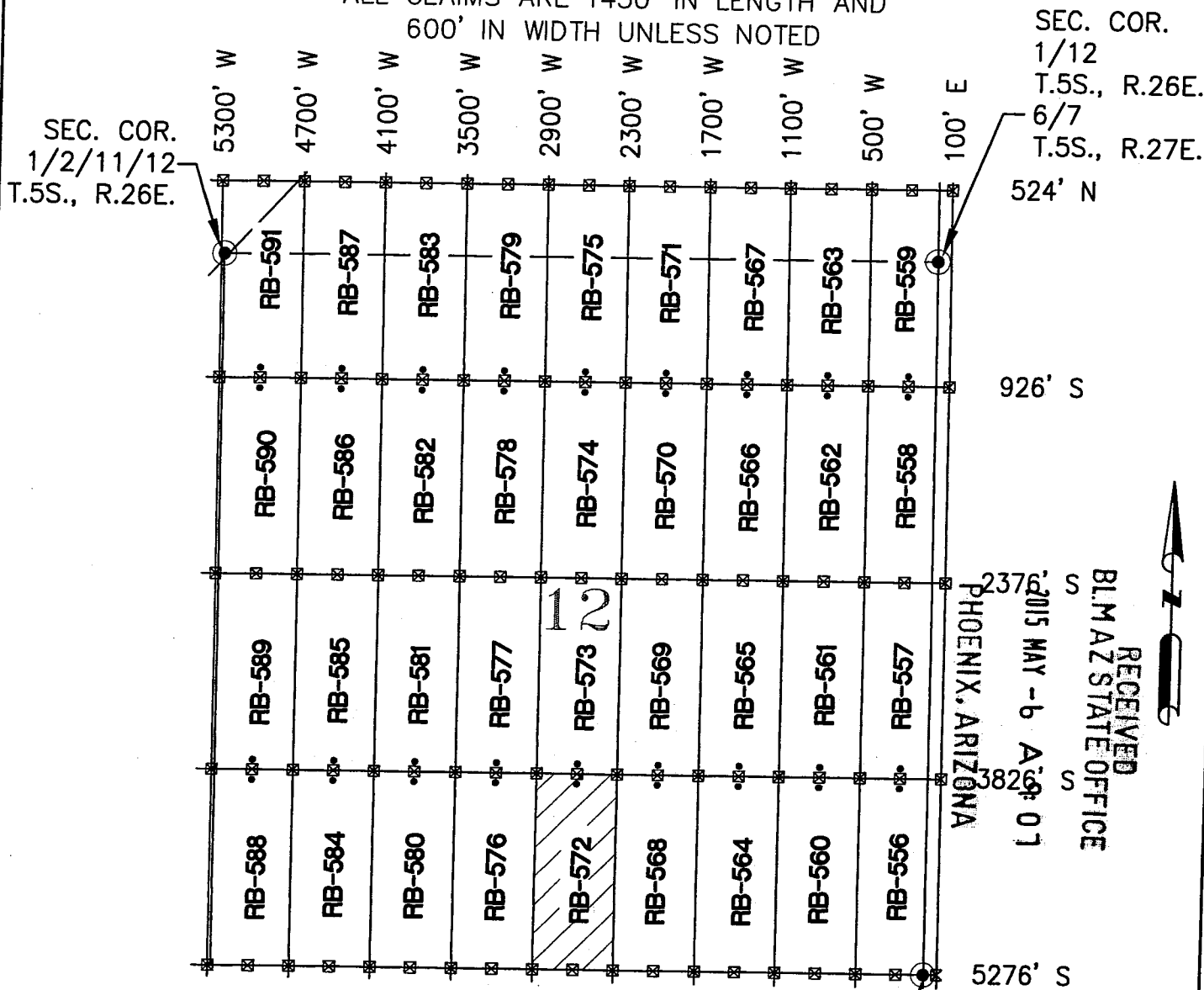

RECEIVED  
BLM AZ STATE OFFICE  
PHOENIX, ARIZONA  
2015 MAY - 6 A:09:01  
382 S

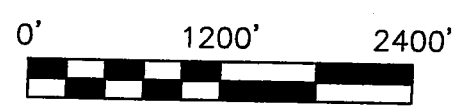
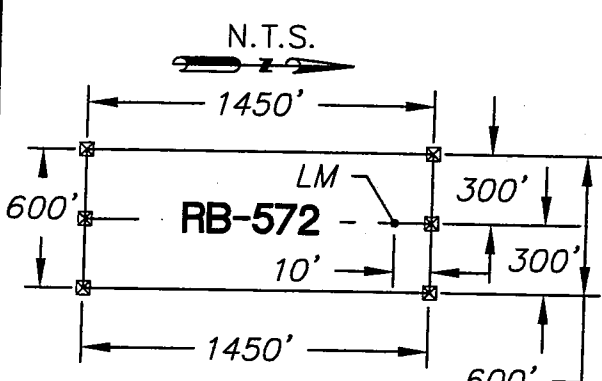

- ☒ INDICATES CORNER OF LODE CLAIM. SET 2"x2"x5' WOODEN POST (TYPICAL)
- INDICATES LOCATION MONUMENT. SET 2"x2"x5' WOODEN POST WITH SIGN (TYPICAL)

LOCATORS:  
FREEPORT MINERALS CORP.  
PO BOX 1019  
SAFFORD AZ 85548

CLAIM ACREAGE = 20.0 AC  
WC = WITNESS CORNER NORTH  
OF SIDE LINE

**Entellus™**  
2255 N. 44th Street Suite 125  
Phoenix, AZ 85008.3279  
Tel 602.244.2566  
Fax 602.244.8947  
Website: www.Entellus.com

**LOCATION NOTICE FOR LODE MINING CLAIM**

Amendment      BLM Serial # \_\_\_\_\_

NOTICE IS HEREBY GIVEN that the Red Bull - 573

\_\_\_\_\_ lode mining claim has been located

by Freeport Minerals Corporation whose current mailing

address is P.O. Box 1019

Safford, Arizona 85548

The general course of this claim is North to South and it is situated in \_\_\_\_\_

County, Arizona. This claim is 1450 feet in length and 600 feet in width.

20.0 Total Claim Acreage. This claim runs from the location monument on which this location notice is posted on the centerline of the claim approximately 10 feet in a Southerly direction to the South end line and 1440 feet in a Northerly direction to the North end line. This claim is marked by six

monuments, one at each corner and one at the center of each end line of the claim.

The location monument on which this notice is posted is situated within Section 12 Township 5

S, Range 26 E, Gila Salt River Base and Meridian, Arizona and this claim encompasses portions

of the following quarter section(s), section(s), Township(s) and Range(s) SE 1/4 SW 1/4 NE 1/4 NW 1/4

Section 12 Township 5S Range 26E

Gila Salt River Base and Meridian, Arizona.

The locality of this claim with reference to some natural object or permanent monument and additional information

(if any) concerning its locality are as follows: The Northeast corner of the claim is 2376' South and 2300' West of the monument at the Northeast Corner of Section 12, Township 5S, Range 26E

The above information is shown on the attached map.

DATED AND POSTED on the ground this 14 day of April, 2015

LOCATOR(s)       AGENT

Print Name(s) Entellus, Inc. - Daniel G. Francetic, RLS

Signature(s) *Daniel G. Francetic*

RECEIVED  
BLM/ARIZONA STATE OFFICE  
2015 MAY -6 A 9:05  
PHOENIX, ARIZONA  
Graham  
BLM  
Date  
Stamp

AMC 432217

Form MCF100  
Revised July 2014

# RED BULL - 573 CLAIM

## LOCATION OF RED BULL-556 THROUGH RED BULL-591 LODE CLAIMS

LOCATED IN SECTIONS 1, 2, 11, 12, T.5S., R.26E. AND SECTIONS 6, & 7, T.5S., R.27E.  
GRAHAM COUNTY, ARIZONA

ALL CLAIMS ARE 1450' IN LENGTH AND  
600' IN WIDTH UNLESS NOTED

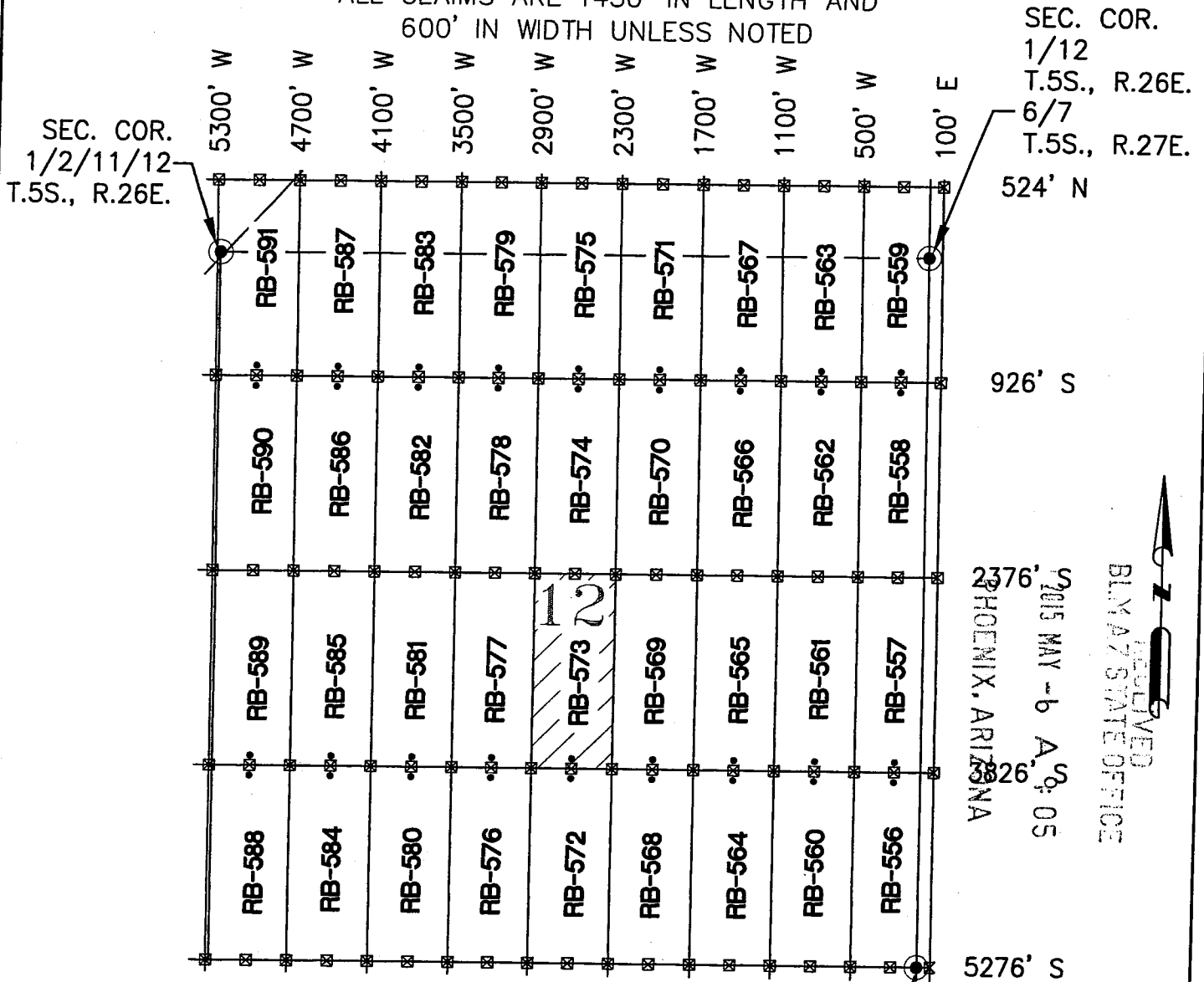

RECEIVED  
BLM AZ STATE OFFICE  
2015 MAY - 6 A 9:05  
PHOENIX, ARIZONA

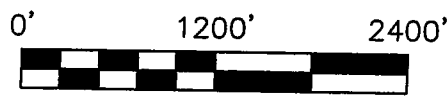
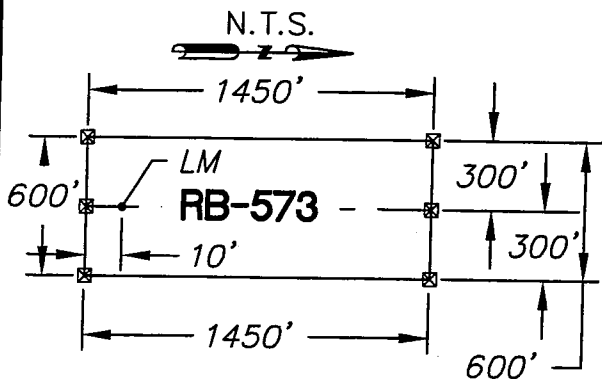

- ☒ INDICATES CORNER OF LODE CLAIM. SET 2"x2"x5' WOODEN POST (TYPICAL)
- INDICATES LOCATION MONUMENT. SET 2"x2"x5' WOODEN POST WITH SIGN (TYPICAL)

LOCATORS:  
FREEPORT MINERALS CORP.  
PO BOX 1019  
SAFFORD AZ 85548

CLAIM ACREAGE = 20.0 AC  
WC = WITNESS CORNER NORTH  
OF SIDE LINE

**Entellus™**  
2255 N. 44th Street Suite 125  
Phoenix, AZ 85008.3279  
Tel 602.244.2566  
Fax 602.244.8947  
Website: www.Entellus.com

SEC. COR.  
12/13 T.5S., R.26E.  
7/18 T.5S., R.27E.

**LOCATION NOTICE FOR LODE MINING CLAIM**

Amendment      BLM Serial # \_\_\_\_\_

NOTICE IS HEREBY GIVEN that the Red Bull - 574

\_\_\_\_\_ lode mining claim has been located

by Freeport Minerals Corporation whose current mailing

address is P.O. Box 1019

Safford, Arizona 85548

RECEIVED  
BLM STATE OFFICE  
PHOENIX, ARIZONA  
2015 MAY -6 A 9:05  
BLM  
Date  
Stamp

The general course of this claim is North to South and it is situated in Graham

County, Arizona. This claim is 1450 feet in length and 600 feet in width.

20.0 Total Claim Acreage. This claim runs from the location monument on which this location notice is posted on the centerline of the claim approximately 10 feet in a Northerly direction to the North end line and 1440 feet in a Southerly direction to the South end line. This claim is marked by six

monuments, one at each corner and one at the center of each end line of the claim.

The location monument on which this notice is posted is situated within Section 12 Township 5

S, Range 26 E, Gila Salt River Base and Meridian, Arizona and this claim encompasses portions

of the following quarter section(s), section(s), Township(s) and Range(s) NE 1/4 NW 1/4

Section 12 Township 5S Range 26E

Gila Salt River Base and Meridian, Arizona.

The locality of this claim with reference to some natural object or permanent monument and additional information

(if any) concerning its locality are as follows: The Northeast corner of the claim is 926' South and 2300' West of the monument at the Northeast Corner of Section 12, Township 5S, Range 26E

The above information is shown on the attached map.

DATED AND POSTED on the ground this 15 day of April, 2015.

LOCATOR(s)       AGENT

Print Name(s) Entellus, Inc. - Daniel G. Francetic, RLS

Signature(s) *Daniel G. Francetic*

Form MCF100  
Revised July 2014

This form is available from the Arizona Geological Survey and may be reproduced.

AMC432218



# RED BULL - 574 CLAIM

## LOCATION OF RED BULL-556 THROUGH RED BULL-591 LODE CLAIMS

LOCATED IN SECTIONS 1, 2, 11, 12, T.5S., R.26E. AND SECTIONS 6, & 7, T.5S., R.27E.  
GRAHAM COUNTY, ARIZONA

ALL CLAIMS ARE 1450' IN LENGTH AND  
600' IN WIDTH UNLESS NOTED

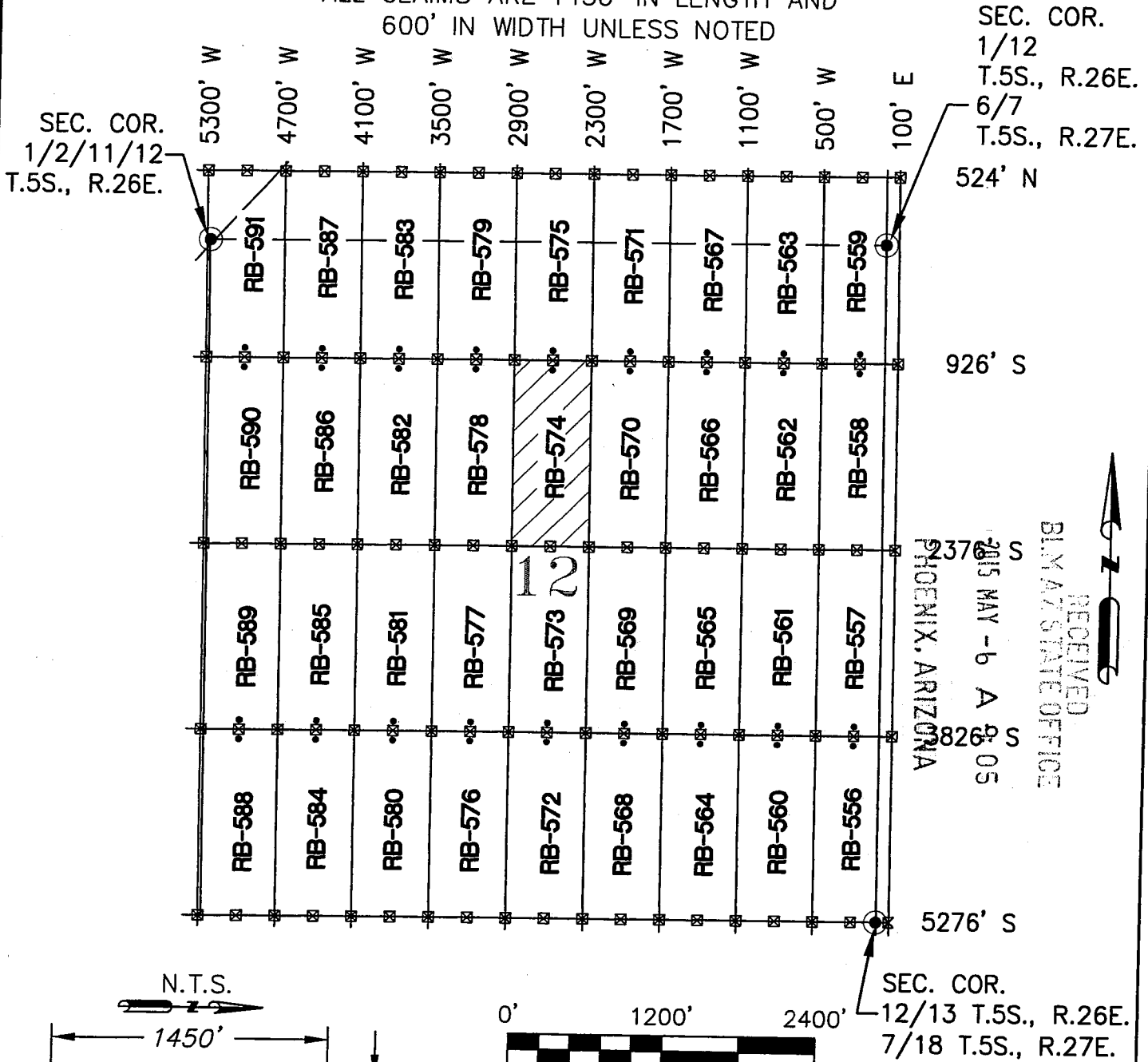

RECEIVED  
BLM AT STATE OFFICE  
PHOENIX, ARIZONA  
MAY - 6 2015  
8 26 05

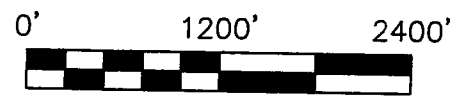
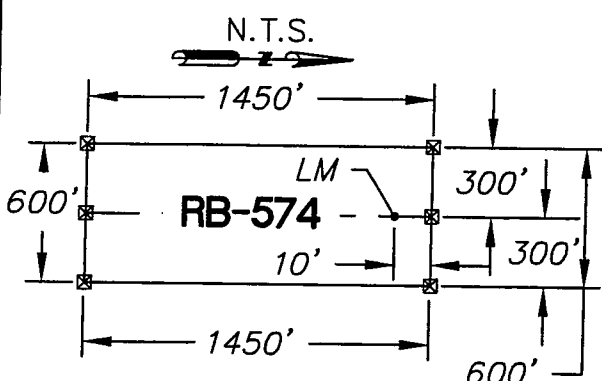

- ☒ INDICATES CORNER OF LODE CLAIM. SET 2"x2"x5' WOODEN POST (TYPICAL)
- INDICATES LOCATION MONUMENT. SET 2"x2"x5' WOODEN POST WITH SIGN (TYPICAL)

LOCATORS:  
FREEPORT MINERALS CORP.  
PO BOX 1019  
SAFFORD AZ 85548

CLAIM ACREAGE = 20.0 AC  
WC = WITNESS CORNER NORTH  
OF SIDE LINE

**Entellus™**  
2255 N. 44th Street Suite 125  
Phoenix, AZ 85008.3279  
Tel 602.244.2566  
Fax 602.244.8947  
Website: www.Entellus.com

**LOCATION NOTICE FOR LODE MINING CLAIM**

Amendment BLM Serial # \_\_\_\_\_

NOTICE IS HEREBY GIVEN that the Red Bull - 575

\_\_\_\_\_ lode mining claim has been located

by Freeport Minerals Corporation whose current mailing

address is P.O. Box 1019

Safford, Arizona 85548

RECEIVED  
BLM AZ STATE OFFICE  
2015 MAY -6 A 9:05  
PHOENIX, ARIZONA

BLM  
Date  
Stamp

The general course of this claim is North to South and it is situated in Graham

County, Arizona. This claim is 1450 feet in length and 600 feet in width.

20.0 Total Claim Acreage. This claim runs from the location monument on which this location notice

is posted on the centerline of the claim approximately 10 feet in a Southerly direction to the South

end line and 1440 feet in a Northerly direction to the North end line. This claim is marked by six

monuments, one at each corner and one at the center of each end line of the claim.

The location monument on which this notice is posted is situated within Section 12 Township 5

S, Range 26 E, Gila Salt River Base and Meridian, Arizona and this claim encompasses portions

of the following quarter section(s), section(s), Township(s) and Range(s) NE 1/4 NW 1/4 Section 12 Township 5S Range 26E

SE 1/4, SW 1/4 Section 1 Township 5S Range 26E

Gila Salt River Base and Meridian, Arizona.

The locality of this claim with reference to some natural object or permanent monument and additional information

(if any) concerning its locality are as follows: The Northeast corner of the claim is 524' North and 2300' West of the monument at the

Northeast Corner of Section 12, Township 5S, Range 26E

The above information is shown on the attached map.

DATED AND POSTED on the ground this 15 day of April, 2015.

LOCATOR(s)  AGENT

Print Name(s) Entellus, Inc. - Daniel G. Francetic, RLS

Signature(s) Daniel G. Francetic

Form MCF100  
Revised July 2014

This form is available from the Arizona Geological Survey and may be reproduced.

AMC 432219

# RED BULL - 575 CLAIM

LOCATION OF RED BULL-556 THROUGH RED BULL-591 LODE CLAIMS

LOCATED IN SECTIONS 1, 2, 11, 12, T.5S., R.26E. AND SECTIONS 6, & 7, T.5S., R.27E.  
GRAHAM COUNTY, ARIZONA

ALL CLAIMS ARE 1450' IN LENGTH AND  
600' IN WIDTH UNLESS NOTED

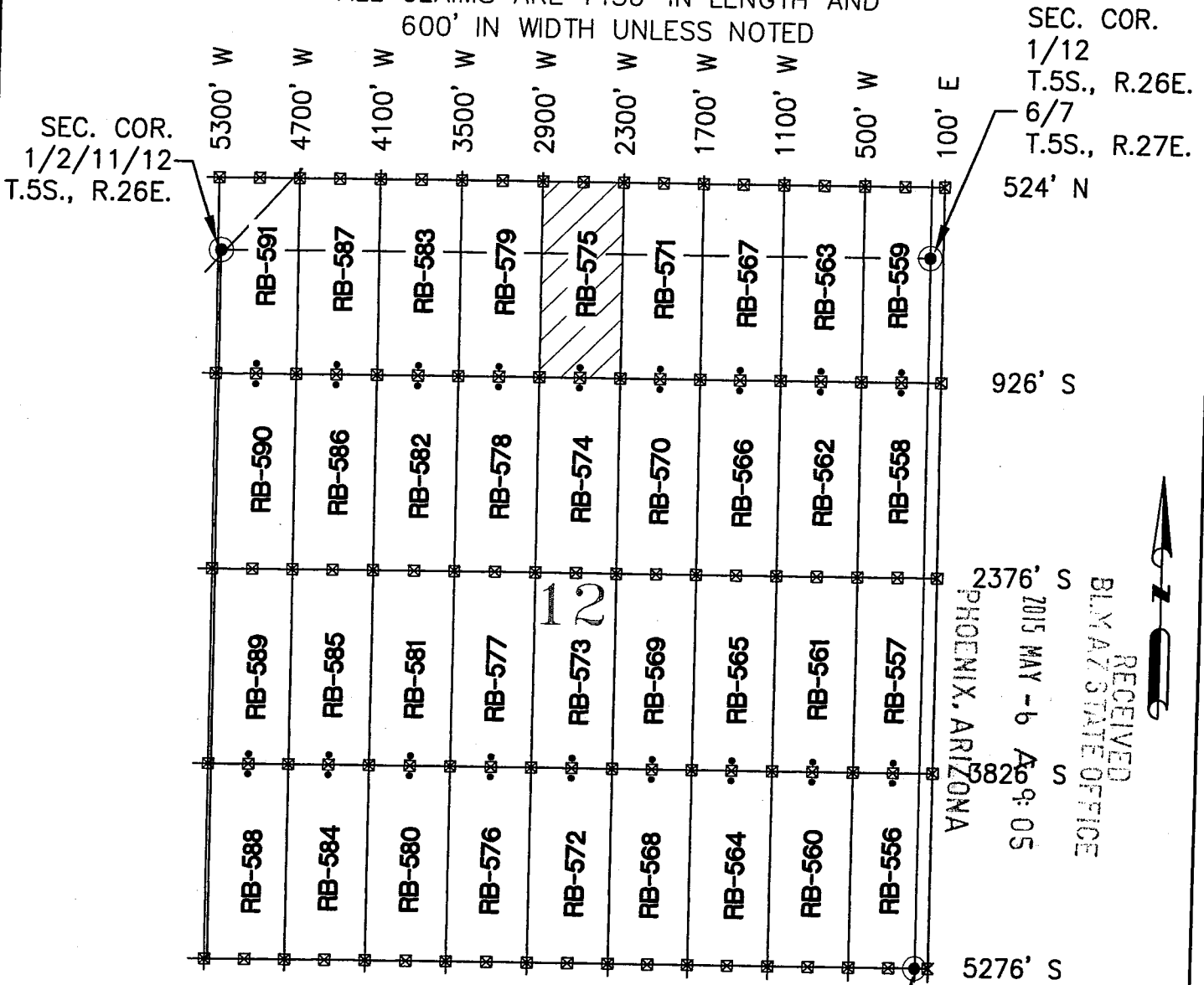

RECEIVED  
BLM AZ STATE OFFICE  
PHOENIX, ARIZONA  
2015 MAY - 6 AM 9:05  
2376' S  
382' S

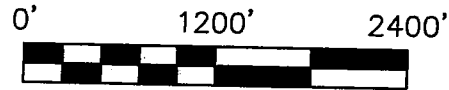
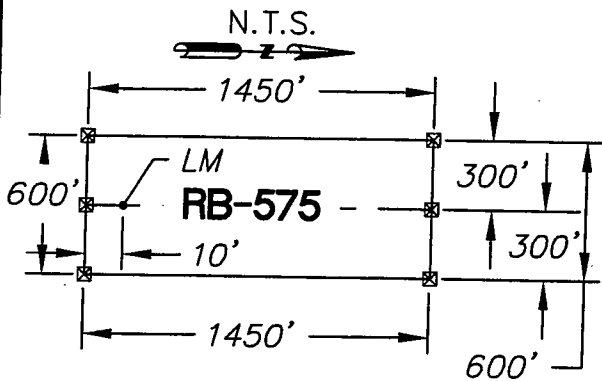

- ☒ INDICATES CORNER OF LODE CLAIM. SET 2"x2"x5' WOODEN POST (TYPICAL)
- INDICATES LOCATION MONUMENT. SET 2"x2"x5' WOODEN POST WITH SIGN (TYPICAL)

LOCATORS:  
FREEPORT MINERALS CORP.  
PO BOX 1019  
SAFFORD AZ 85548

CLAIM ACREAGE = 20.0 AC  
WC = WITNESS CORNER NORTH  
OF SIDE LINE

**Entellus™**  
2255 N. 44th Street Suite 125  
Phoenix, AZ 85008.3279  
Tel 602.244.2566  
Fax 602.244.8947  
Website: www.Entellus.com

**LOCATION NOTICE FOR LODE MINING CLAIM**

Amendment      BLM Serial # \_\_\_\_\_

NOTICE IS HEREBY GIVEN that the Red Bull - 576

\_\_\_\_\_ lode mining claim has been located

by Freeport Minerals Corporation whose current mailing

address is P.O. Box 1019

Safford, Arizona 85548

RECEIVED  
BLM AT STATE OFFICE  
2015 MAY -6 A 9:05  
PHOENIX, ARIZONA

BLM  
Date  
Stamp

The general course of this claim is North to South and it is situated in Graham

County, Arizona. This claim is 1450 feet in length and 600 feet in width.

20.0 Total Claim Acreage. This claim runs from the location monument on which this location notice

is posted on the centerline of the claim approximately 10 feet in a Northerly direction to the North

end line and 1440 feet in a Southerly direction to the South end line. This claim is marked by six

monuments, one at each corner and one at the center of each end line of the claim.

The location monument on which this notice is posted is situated within Section 12 Township 5

S, Range 26 E, Gila Salt River Base and Meridian, Arizona and this claim encompasses portions

of the following quarter section(s), section(s), Township(s) and Range(s) SW 1/4

Section 12 Township 5S Range 26E  
Gila Salt River Base and Meridian, Arizona.

The locality of this claim with reference to some natural object or permanent monument and additional information

(if any) concerning its locality are as follows: The Northeast corner of the claim is 3826' South and 2900' West of the monument at the  
Northeast Corner of Section 12, Township 5S, Range 26E

The above information is shown on the attached map.

DATED AND POSTED on the ground this 14 day of April, 2015

LOCATOR(s)       AGENT

Print Name(s) Entellus, Inc. - Daniel G. Francetic, RLS

Signature(s) *Daniel G. Francetic*

Form MCF100  
Revised July 2014

This form is available from the Arizona Geological Survey and may be reproduced.

AMC432220

# RED BULL - 576 CLAIM

## LOCATION OF RED BULL-556 THROUGH RED BULL-591 LODE CLAIMS

LOCATED IN SECTIONS 1, 2, 11, 12, T.5S., R.26E. AND SECTIONS 6, & 7, T.5S., R.27E.  
GRAHAM COUNTY, ARIZONA

ALL CLAIMS ARE 1450' IN LENGTH AND  
600' IN WIDTH UNLESS NOTED

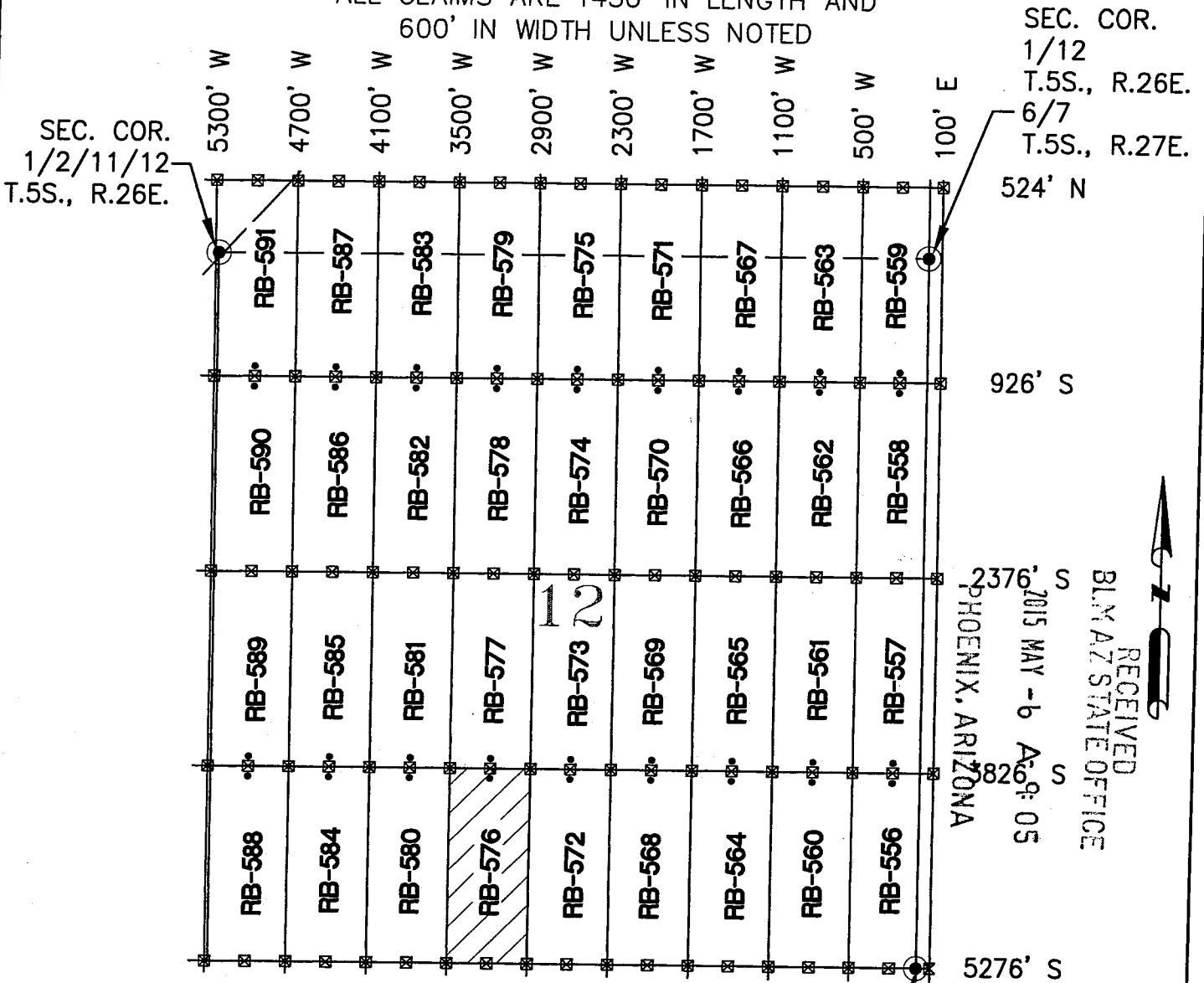

RECEIVED  
BLM AZ STATE OFFICE  
PHOENIX, ARIZONA  
MAY - 6 2015  
8:09:05

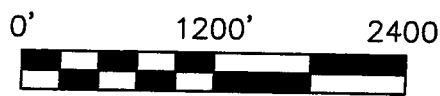
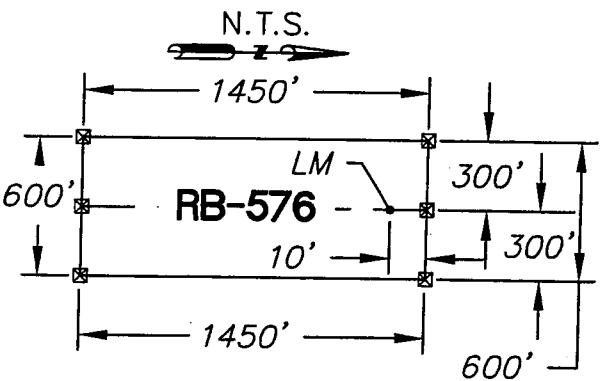

- ☒ INDICATES CORNER OF LODE CLAIM. SET 2"x2"x5' WOODEN POST (TYPICAL)
- INDICATES LOCATION MONUMENT. SET 2"x2"x5' WOODEN POST WITH SIGN (TYPICAL)

LOCATORS:  
FREEPORT MINERALS CORP.  
PO BOX 1019  
SAFFORD AZ 85548

CLAIM ACREAGE = 20.0 AC  
WC = WITNESS CORNER NORTH  
OF SIDE LINE

**Entellus**  
2255 N. 44th Street Suite 125  
Phoenix, AZ 85008.3279  
Tel 602.244.2566  
Fax 602.244.8947  
Website: www.Entellus.com

SEC. COR.  
12/13 T.5S., R.26E.  
7/18 T.5S., R.27E.

**LOCATION NOTICE FOR LODE MINING CLAIM**

Amendment BLM Serial # \_\_\_\_\_

NOTICE IS HEREBY GIVEN that the Red Bull - 577

\_\_\_\_\_ lode mining claim has been located

by Freeport Minerals Corporation whose current mailing

address is P.O. Box 1019

Safford, Arizona 85548

The general course of this claim is North to South and it is situated in \_\_\_\_\_

County, Arizona. This claim is 1450 feet in length and 600 feet in width.

20.0 Total Claim Acreage. This claim runs from the location monument on which this location notice

is posted on the centerline of the claim approximately 10 feet in a Southerly direction to the South

end line and 1440 feet in a Northerly direction to the North end line. This claim is marked by six

monuments, one at each corner and one at the center of each end line of the claim.

The location monument on which this notice is posted is situated within Section 12 Township 5

S, Range 26 E, Gila Salt River Base and Meridian, Arizona and this claim encompasses portions

of the following quarter section(s), section(s), Township(s) and Range(s) SW 1/4 NW 1/4

Section 12 Township 5S Range 26E

Gila Salt River Base and Meridian, Arizona.

The locality of this claim with reference to some natural object or permanent monument and additional information

(if any) concerning its locality are as follows: The Northeast corner of the claim is 2376' South and 2900' West of the monument at the

Northeast Corner of Section 12, Township 5S, Range 26E

The above information is shown on the attached map.

DATED AND POSTED on the ground this 14 day of April, 2015.

LOCATOR(s)  AGENT

Print Name(s) Entellus, Inc. - Daniel G. Francetic, RLS

Signature(s) *Daniel G. Francetic*

RECEIVED  
BLM AZ STATE OFFICE  
2015 MAY -6 A 9:05  
PHOENIX, ARIZONA  
BLM  
Date  
Stamp

AMC432221

Form MCF100  
Revised July 2014

# RED BULL - 577 CLAIM

## LOCATION OF RED BULL-556 THROUGH RED BULL-591 LODE CLAIMS

LOCATED IN SECTIONS 1, 2, 11, 12, T.5S., R.26E. AND SECTIONS 6, & 7, T.5S., R.27E.  
GRAHAM COUNTY, ARIZONA

ALL CLAIMS ARE 1450' IN LENGTH AND  
600' IN WIDTH UNLESS NOTED

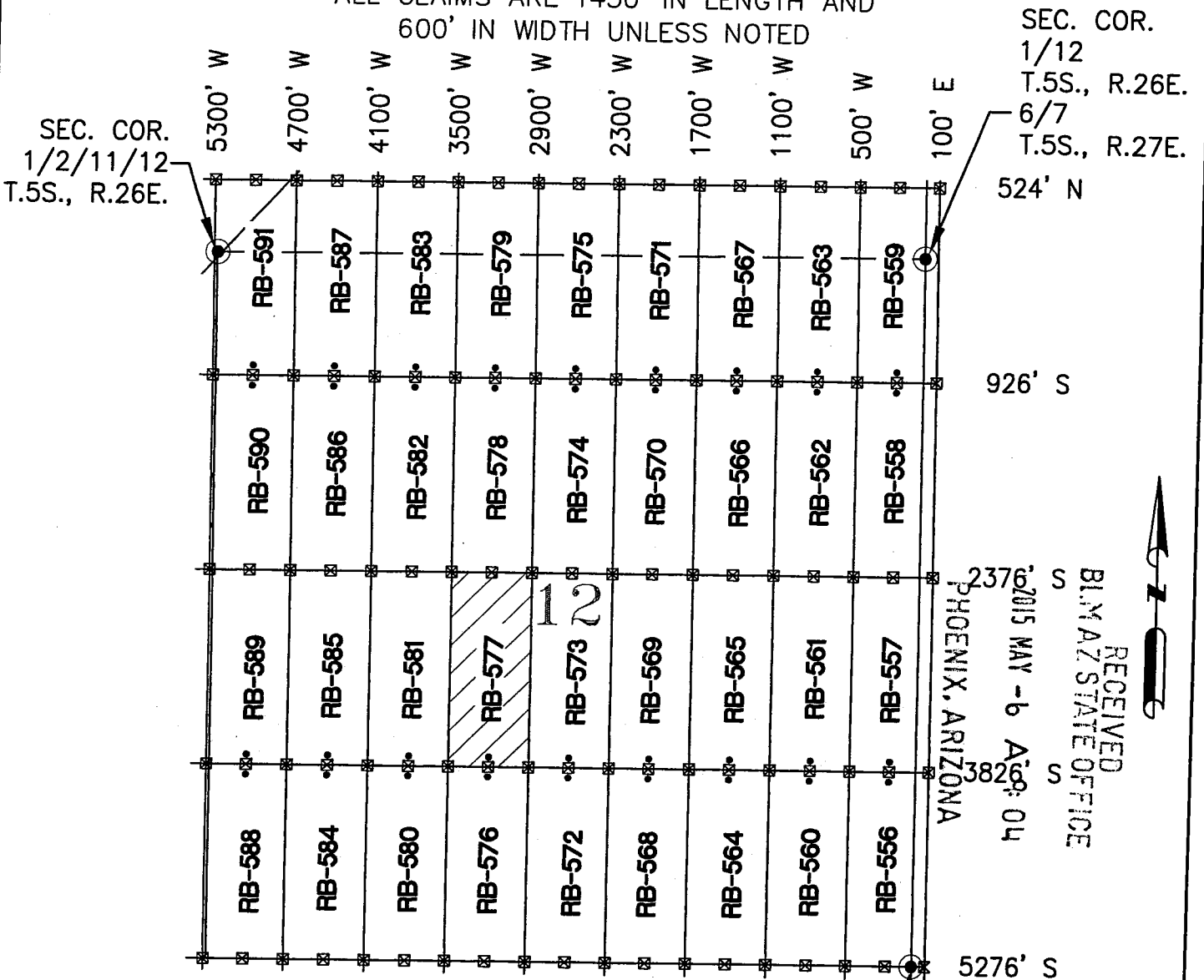

RECEIVED  
BLM AZ STATE OFFICE  
PHOENIX, ARIZONA  
2015 MAY - 6 AM 9:04  
382

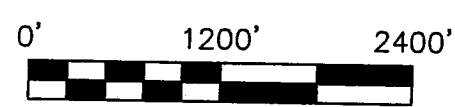
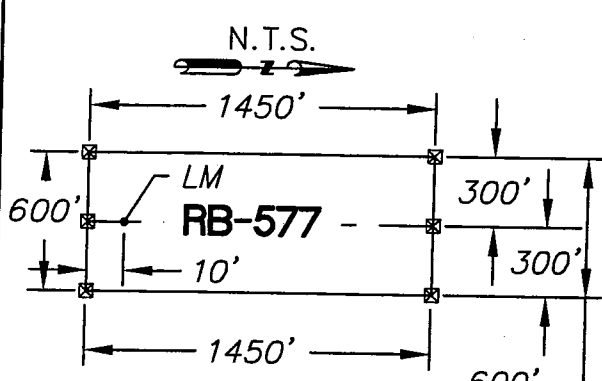

- ☒ INDICATES CORNER OF LODE CLAIM. SET 2"x2"x5' WOODEN POST (TYPICAL)
- INDICATES LOCATION MONUMENT. SET 2"x2"x5' WOODEN POST WITH SIGN (TYPICAL)

LOCATORS:  
FREEPORT MINERALS CORP.  
PO BOX 1019  
SAFFORD AZ 85548

CLAIM ACREAGE = 20.0 AC  
WC = WITNESS CORNER NORTH  
OF SIDE LINE

**Entellus**  
2255 N. 44th Street Suite 125  
Phoenix, AZ 85008.3279  
Tel 602.244.2566  
Fax 602.244.8947  
Website: www.Entellus.com

LOCATION NOTICE FOR LODE MINING CLAIM

Amendment BLM Serial # \_\_\_\_\_

NOTICE IS HEREBY GIVEN that the Red Bull - 578

\_\_\_\_\_ lode mining claim has been located  
by Freeport Minerals Corporation whose current mailing  
address is P.O. Box 1019  
Safford, Arizona 85548

RECEIVED  
BLM AZ STATE OFFICE  
2015 MAY -6 A 9:04  
PHOENIX, ARIZONA  
BLM  
Date  
Stamp  
Graham

The general course of this claim is North to South and it is situated in \_\_\_\_\_  
County, Arizona. This claim is 1450 feet in length and 600 feet in width.

20.0 Total Claim Acreage. This claim runs from the location monument on which this location notice  
is posted on the centerline of the claim approximately 10 feet in a Northerly direction to the North  
end line and 1440 feet in a Southerly direction to the South end line. This claim is marked by six  
monuments, one at each corner and one at the center of each end line of the claim.

The location monument on which this notice is posted is situated within Section 12 Township 5  
S, Range 26 E, Gila Salt River Base and Meridian, Arizona and this claim encompasses portions  
of the following quarter section(s), section(s), Township(s) and Range(s) NW 1/4  
Section 12 Township 5S Range 26E

Gila Salt River Base and Meridian, Arizona.

The locality of this claim with reference to some natural object or permanent monument and additional information  
(if any) concerning its locality are as follows: The Northeast corner of the claim is 926' South and 2900' West of the monument at the  
Northeast Corner of Section 12, Township 5S, Range 26E

The above information is shown on the attached map.

DATED AND POSTED on the ground this 15 day of April, 2015.

LOCATOR(s)  AGENT

Print Name(s) Entellus, Inc. - Daniel G. Francetic, RLS

Signature(s) *Daniel G. Francetic*

Form MCF100  
Revised July 2014

This form is available from the Arizona Geological Survey and may be reproduced.

AMC432222



# RED BULL - 578 CLAIM

## LOCATION OF RED BULL-556 THROUGH RED BULL-591 LODE CLAIMS

LOCATED IN SECTIONS 1, 2, 11, 12, T.5S., R.26E. AND SECTIONS 6, & 7, T.5S., R.27E.  
GRAHAM COUNTY, ARIZONA

ALL CLAIMS ARE 1450' IN LENGTH AND  
600' IN WIDTH UNLESS NOTED

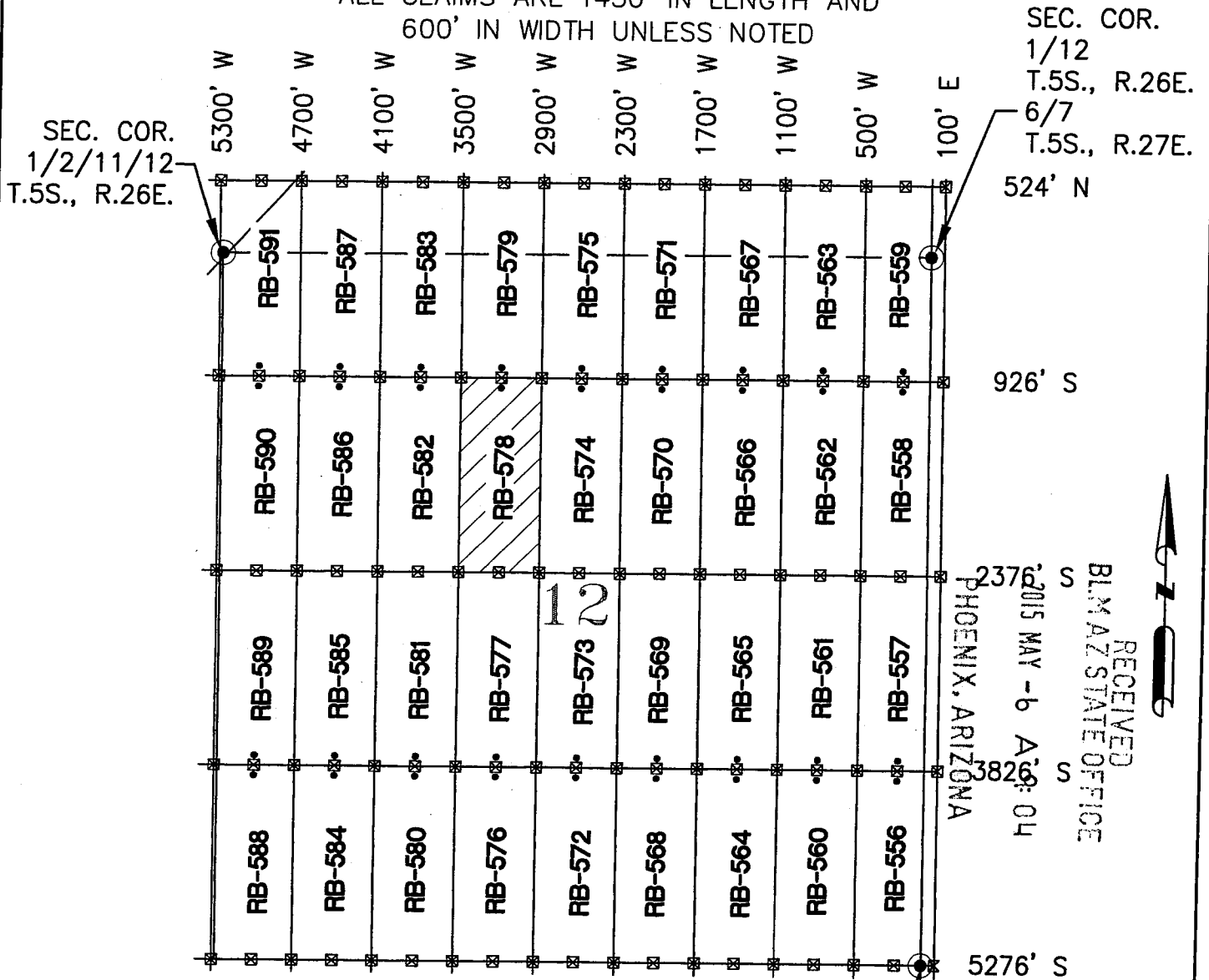

RECEIVED  
BLM AZ STATE OFFICE  
PHOENIX, ARIZONA  
2015 MAY -6 A 9:04

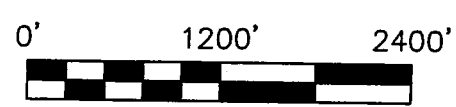
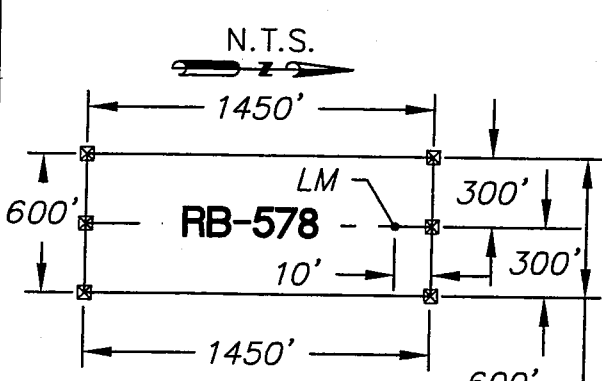

- ☒ INDICATES CORNER OF LODE CLAIM. SET 2"x2"x5' WOODEN POST (TYPICAL)
- INDICATES LOCATION MONUMENT. SET 2"x2"x5' WOODEN POST WITH SIGN (TYPICAL)

LOCATORS:  
FREEPORT MINERALS CORP.  
PO BOX 1019  
SAFFORD AZ 85548

CLAIM ACREAGE = 20.0 AC  
WC = WITNESS CORNER NORTH  
OF SIDE LINE

**Entellus™**  
2255 N. 44th Street Suite 125  
Phoenix, AZ 85008.3279  
Tel 602.244.2566  
Fax 602.244.8947  
Website: www.Entellus.com

**LOCATION NOTICE FOR LODE MINING CLAIM**

Amendment BLM Serial # \_\_\_\_\_

NOTICE IS HEREBY GIVEN that the Red Bull - 579

\_\_\_\_\_ lode mining claim has been located

by Freeport Minerals Corporation whose current mailing

address is P.O. Box 1019

Safford, Arizona 85548

RECEIVED  
BLM AZ STATE OFFICE  
2015 MAY -6 A 9:04  
PHOENIX, ARIZONA  
BLM  
Date  
Stamp

The general course of this claim is North to South and it is situated in Graham

County, Arizona. This claim is 1450 feet in length and 600 feet in width.

20.0 Total Claim Acreage. This claim runs from the location monument on which this location notice is posted on the centerline of the claim approximately 10 feet in a Southerly direction to the South

end line and 1440 feet in a Northerly direction to the North end line. This claim is marked by six monuments, one at each corner and one at the center of each end line of the claim.

The location monument on which this notice is posted is situated within Section 12 Township 5

S, Range 26 E, Gila Salt River Base and Meridian, Arizona and this claim encompasses portions

of the following quarter section(s), section(s), Township(s) and Range(s) NW 1/4

Section 12 Township 5S Range 26E SW 1/4 Section 1 Township 5S Range 26E

Gila Salt River Base and Meridian, Arizona.

The locality of this claim with reference to some natural object or permanent monument and additional information

(if any) concerning its locality are as follows: The Northeast corner of the claim is 524' North and 2900' West of the monument at the Northeast Corner of Section 12, Township 5S, Range 26E

The above information is shown on the attached map.

DATED AND POSTED on the ground this 15 day of April, 2015

LOCATOR(s)  AGENT

Print Name(s) Entellus, Inc. - Daniel G. Francetic, RLS

Signature(s) *Daniel G. Francetic*

Form MCF100  
Revised July 2014

AMC432223

# RED BULL - 579 CLAIM

## LOCATION OF RED BULL-556 THROUGH RED BULL-591 LODE CLAIMS

LOCATED IN SECTIONS 1, 2, 11, 12, T.5S., R.26E. AND SECTIONS 6, & 7, T.5S., R.27E.  
GRAHAM COUNTY, ARIZONA

ALL CLAIMS ARE 1450' IN LENGTH AND  
600' IN WIDTH UNLESS NOTED

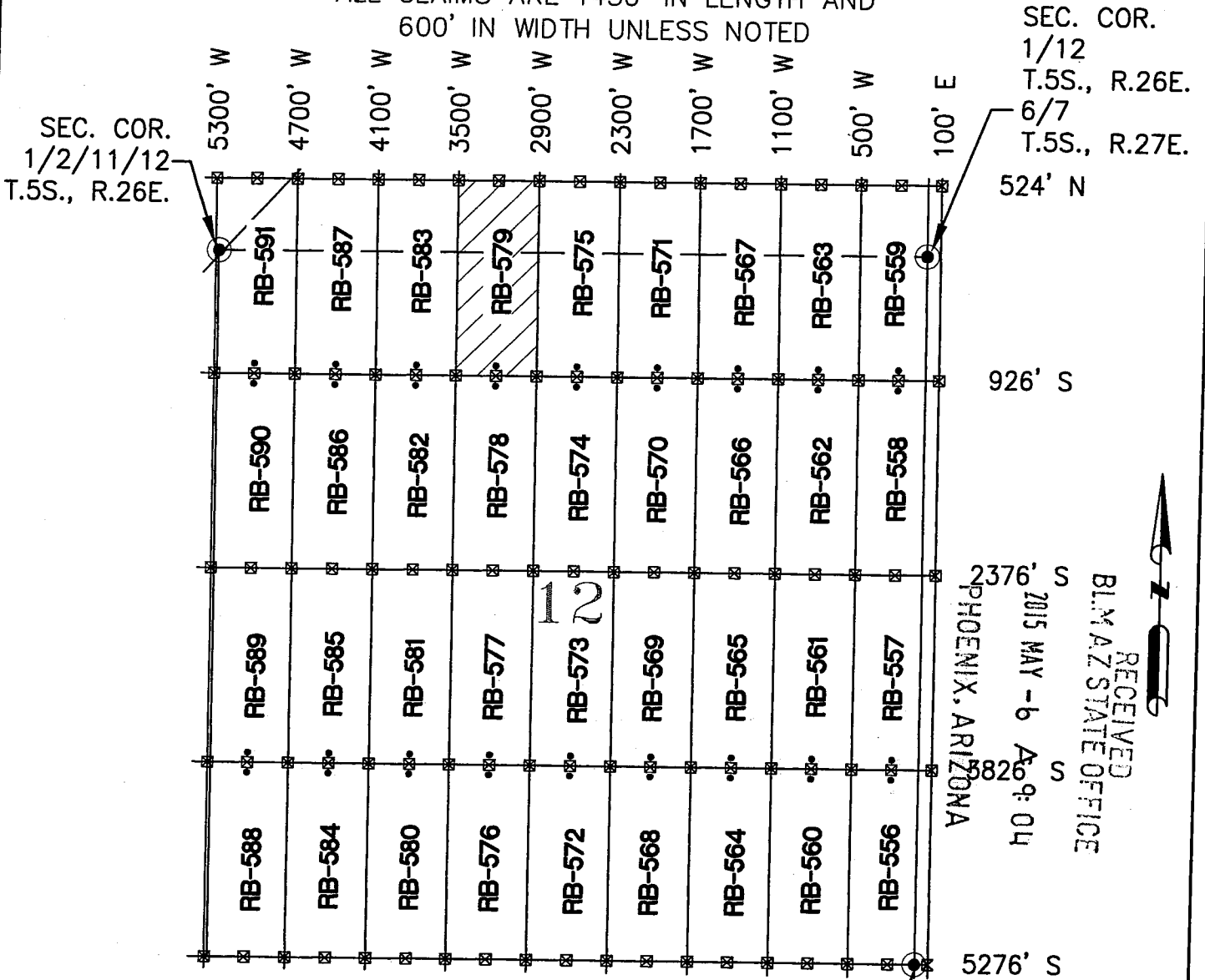

RECEIVED  
BLM AZ STATE OFFICE  
PHOENIX, ARIZONA  
2015 MAY - 6  
8:09:04

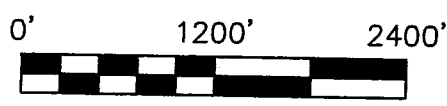
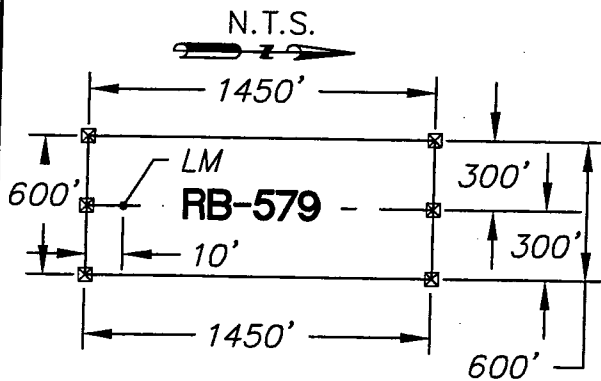

- ☒ INDICATES CORNER OF LODE CLAIM. SET 2"x2"x5' WOODEN POST (TYPICAL)
- INDICATES LOCATION MONUMENT. SET 2"x2"x5' WOODEN POST WITH SIGN (TYPICAL)

LOCATORS:  
FREEPORT MINERALS CORP.  
PO BOX 1019  
SAFFORD AZ 85548

CLAIM ACREAGE = 20.0 AC  
WC = WITNESS CORNER NORTH  
OF SIDE LINE

**Entellus™**  
2255 N. 44th Street Suite 125  
Phoenix, AZ 85008.3279  
Tel 602.244.2566  
Fax 602.244.8947  
Website: www.Entellus.com

**LOCATION NOTICE FOR LODE MINING CLAIM**

Amendment BLM Serial # \_\_\_\_\_

NOTICE IS HEREBY GIVEN that the Red Bull - 580

\_\_\_\_\_ lode mining claim has been located

by Freeport Minerals Corporation whose current mailing

address is P.O. Box 1019

Safford, Arizona 85548

The general course of this claim is North to South and it is situated in \_\_\_\_\_

County, Arizona. This claim is 1450 feet in length and 600 feet in width.

20.0 Total Claim Acreage. This claim runs from the location monument on which this location notice

is posted on the centerline of the claim approximately 10 feet in a Northerly direction to the North

end line and 1440 feet in a Southerly direction to the South end line. This claim is marked by six monuments, one at each corner and one at the center of each end line of the claim.

The location monument on which this notice is posted is situated within Section 12 Township 5

S, Range 26 E, Gila Salt River Base and Meridian, Arizona and this claim encompasses portions

of the following quarter section(s), section(s), Township(s) and Range(s) SW 1/4

Section 12 Township 5S Range 26E

Gila Salt River Base and Meridian, Arizona.

The locality of this claim with reference to some natural object or permanent monument and additional information

(if any) concerning its locality are as follows: The Northeast corner of the claim is 3826' South and 3500' West of the monument at the Northeast Corner of Section 12, Township 5S, Range 26E

The above information is shown on the attached map.

DATED AND POSTED on the ground this 14 day of April, 2015

LOCATOR(s)  AGENT

Print Name(s) Entellus, Inc. - Daniel G. Francetic, RLS

Signature(s) *Daniel G. Francetic*

RECEIVED  
BLM AZ STATE OFFICE  
2015 MAY -6 A 9 04  
PHOENIX, ARIZONA  
Graham  
BLM  
Date  
Stamp

AMC 432224

# RED BULL - 580 CLAIM

## LOCATION OF RED BULL-556 THROUGH RED BULL-591 LODE CLAIMS

LOCATED IN SECTIONS 1, 2, 11, 12, T.5S., R.26E. AND SECTIONS 6, & 7, T.5S., R.27E.  
GRAHAM COUNTY, ARIZONA

ALL CLAIMS ARE 1450' IN LENGTH AND  
600' IN WIDTH UNLESS NOTED

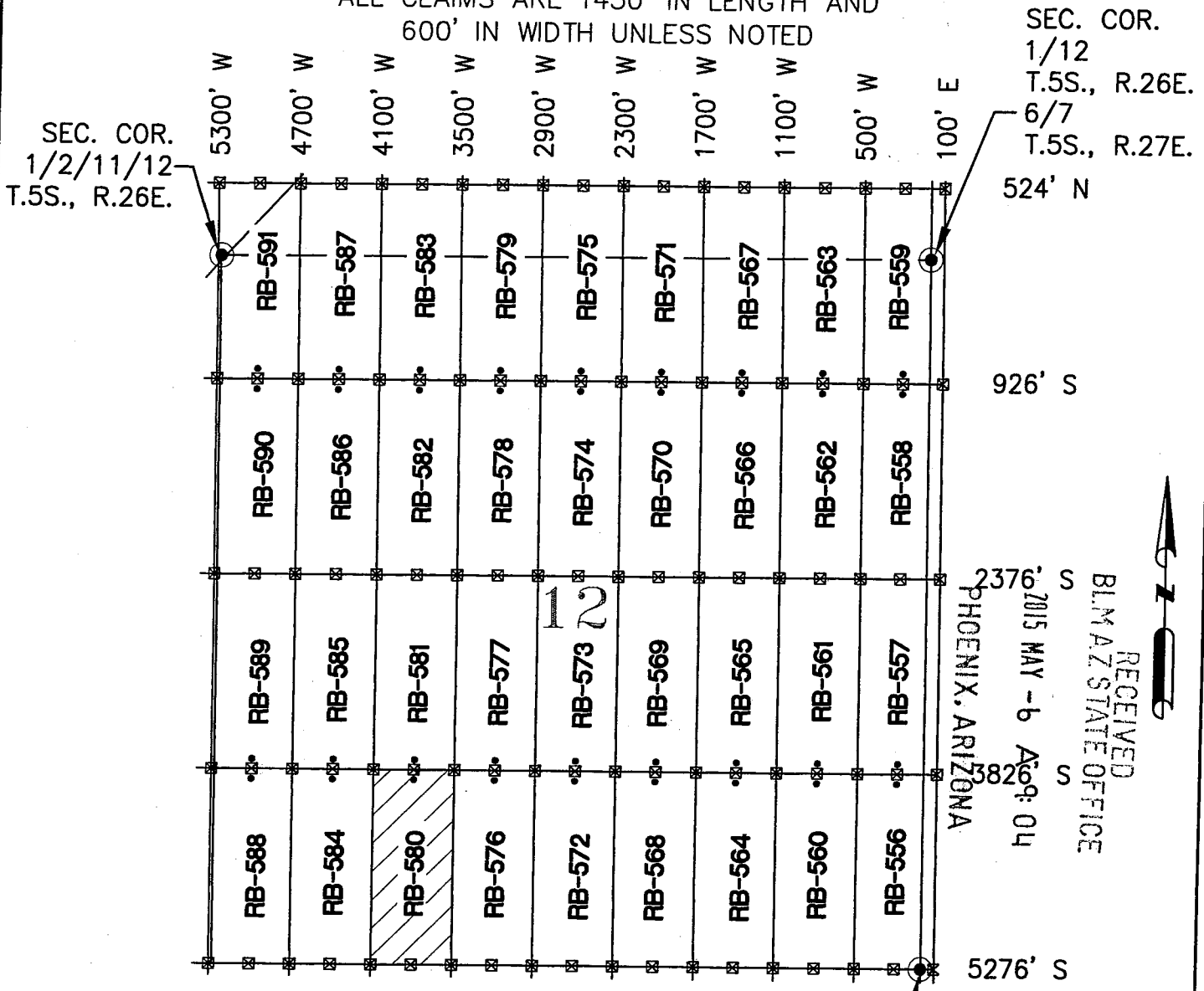

RECEIVED  
 BLM AZ STATE OFFICE  
 PHOENIX, ARIZONA  
 2015 MAY -6  
 382 S  
 5276 S

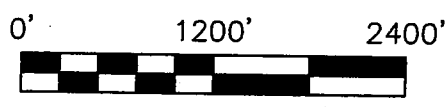
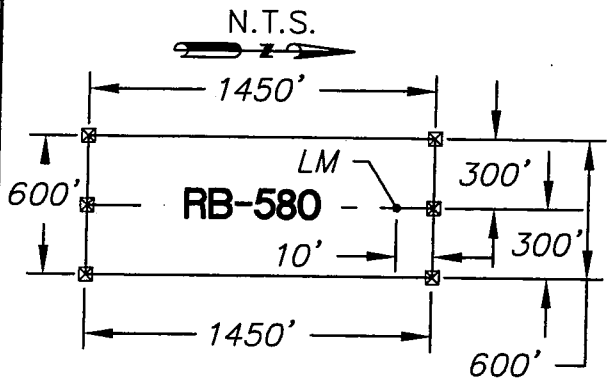

- ☒ INDICATES CORNER OF LODE CLAIM. SET 2"x2"x5' WOODEN POST (TYPICAL)
- INDICATES LOCATION MONUMENT. SET 2"x2"x5' WOODEN POST WITH SIGN (TYPICAL)

LOCATORS:  
 FREEPORT MINERALS CORP.  
 PO BOX 1019  
 SAFFORD AZ 85548

CLAIM ACREAGE = 20.0 AC  
 WC = WITNESS CORNER NORTH  
 OF SIDE LINE

**Entellus™**  
 2255 N. 44th Street Suite 125  
 Phoenix, AZ 85008.3279  
 Tel 602.244.2566  
 Fax 602.244.8947  
 Website: www.Entellus.com

**LOCATION NOTICE FOR LODE MINING CLAIM**

Amendment BLM Serial # \_\_\_\_\_

NOTICE IS HEREBY GIVEN that the Red Bull - 581

\_\_\_\_\_ lode mining claim has been located

by Freeport Minerals Corporation whose current mailing

address is P.O. Box 1019

Safford, Arizona 85548

The general course of this claim is North to South and it is situated in \_\_\_\_\_

County, Arizona. This claim is 1450 feet in length and 600 feet in width.

20.0 Total Claim Acreage. This claim runs from the location monument on which this location notice

is posted on the centerline of the claim approximately 10 feet in a Southerly direction to the South

end line and 1440 feet in a Northerly direction to the North end line. This claim is marked by six monuments, one at each corner and one at the center of each end line of the claim.

The location monument on which this notice is posted is situated within Section 12 Township 5

S, Range 26 E, Gila Salt River Base and Meridian, Arizona and this claim encompasses portions

of the following quarter section(s), section(s), Township(s) and Range(s) SW 1/4 NW 1/4

Section 12 Township 5S Range 26E

Gila Salt River Base and Meridian, Arizona.

The locality of this claim with reference to some natural object or permanent monument and additional information

(if any) concerning its locality are as follows: The Northeast corner of the claim is 2376' South and 3500' West of the monument at the Northeast Corner of Section 12, Township 5S, Range 26E

The above information is shown on the attached map.

DATED AND POSTED on the ground this 14 day of April, 2015

LOCATOR(s)  AGENT

Print Name(s) Entellus, Inc. - Daniel G. Francetic, RLS

Signature(s) *Daniel G. Francetic*

RECEIVED  
BLM AZ STATE OFFICE  
2015 MAY -6 A 9:04  
PHOENIX, ARIZONA  
Graham  
BLM Date Stamp

AMC 432223

# RED BULL - 581 CLAIM

LOCATION OF RED BULL-556 THROUGH RED BULL-591 LODE CLAIMS

LOCATED IN SECTIONS 1, 2, 11, 12, T.5S., R.26E. AND SECTIONS 6, & 7, T.5S., R.27E.  
GRAHAM COUNTY, ARIZONA

ALL CLAIMS ARE 1450' IN LENGTH AND  
600' IN WIDTH UNLESS NOTED

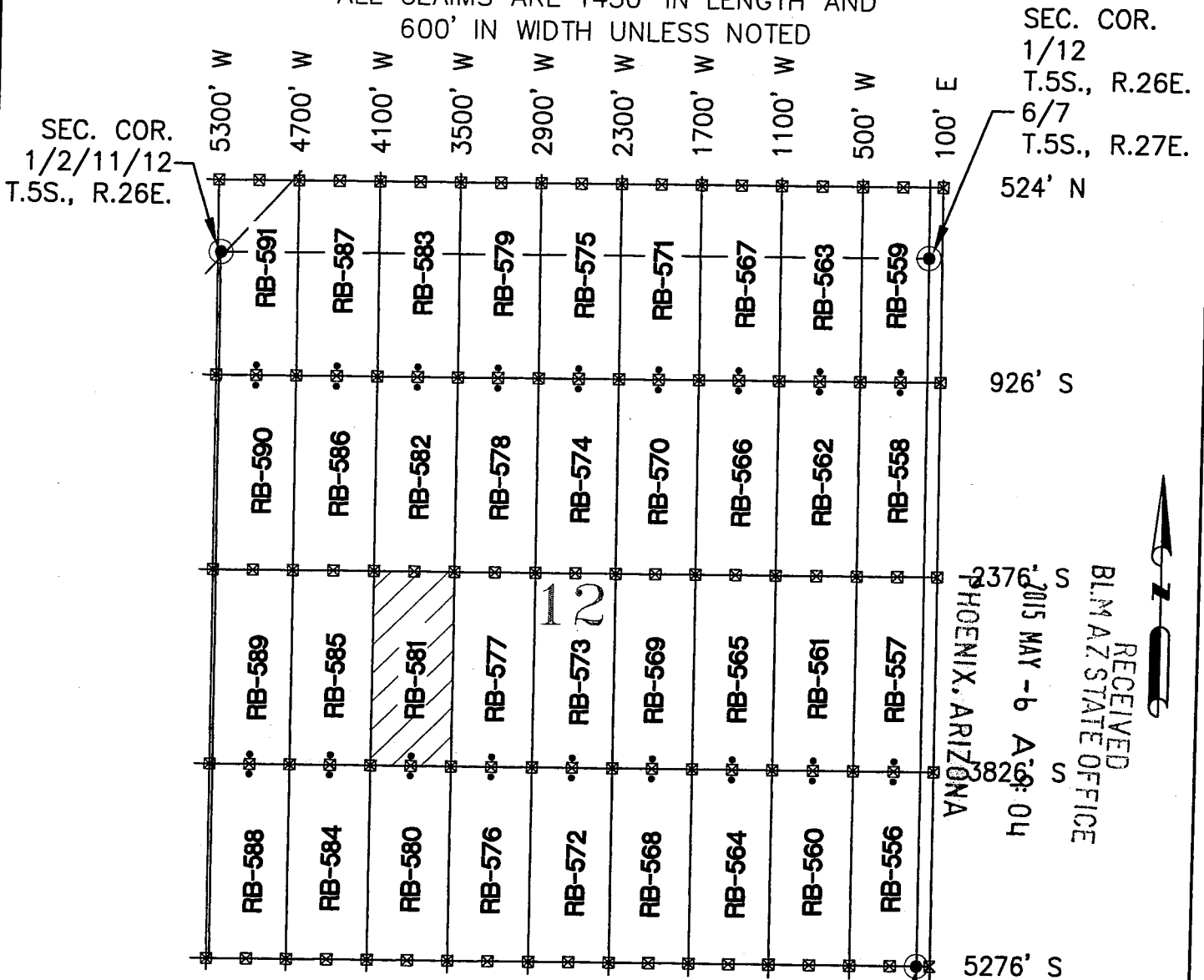

RECEIVED  
BLM AZ STATE OFFICE  
PHOENIX, ARIZONA  
MAY - 6 2015  
3:04 PM

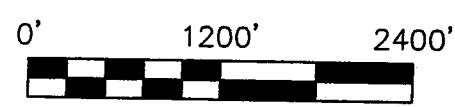
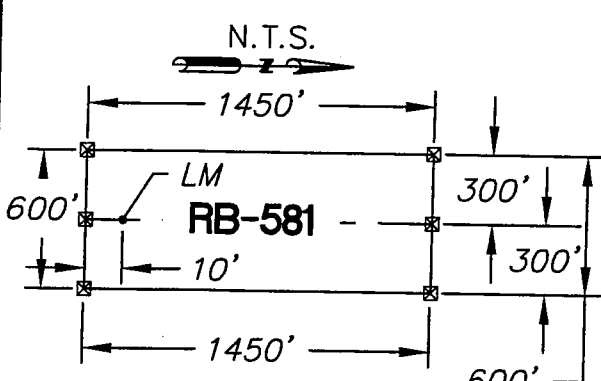

- ☒ INDICATES CORNER OF LODE CLAIM. SET 2"x2"x5' WOODEN POST (TYPICAL)
- INDICATES LOCATION MONUMENT. SET 2"x2"x5' WOODEN POST WITH SIGN (TYPICAL)

LOCATORS:  
FREEPORT MINERALS CORP.  
PO BOX 1019  
SAFFORD AZ 85548

CLAIM ACREAGE = 20.0 AC  
WC = WITNESS CORNER NORTH  
OF SIDE LINE

**Entellus™**  
2255 N. 44th Street Suite 125  
Phoenix, AZ 85008.3279  
Tel 602.244.2566  
Fax 602.244.8947  
Website: www.Entellus.com

**LOCATION NOTICE FOR LODE MINING CLAIM**

Amendment      BLM Serial # \_\_\_\_\_

NOTICE IS HEREBY GIVEN that the Red Bull - 582

\_\_\_\_\_ lode mining claim has been located

by Freeport Minerals Corporation whose current mailing

address is P.O. Box 1019

Safford, Arizona 85548

RECEIVED  
BLM AZ STATE OFFICE  
2015 MAY -6 A 9: 04  
PHOENIX, ARIZONA  
BLM  
Date  
Stamp

The general course of this claim is North to South and it is situated in \_\_\_\_\_ Graham

County, Arizona. This claim is 1450 feet in length and 600 feet in width.

20.0 Total Claim Acreage. This claim runs from the location monument on which this location notice

is posted on the centerline of the claim approximately 10 feet in a Northerly direction to the North

end line and 1440 feet in a Southerly direction to the South end line. This claim is marked by six

monuments, one at each corner and one at the center of each end line of the claim.

The location monument on which this notice is posted is situated within Section 12 Township 5

S, Range 26 E, Gila Salt River Base and Meridian, Arizona and this claim encompasses portions

of the following quarter section(s), section(s), Township(s) and Range(s) NW 1/4

Section 12 Township 5S Range 26E

Gila Salt River Base and Meridian, Arizona.

The locality of this claim with reference to some natural object or permanent monument and additional information

(if any) concerning its locality are as follows: The Northeast corner of the claim is 926' South and 3500' West of the monument at the

Northeast Corner of Section 12, Township 5S, Range 26E

The above information is shown on the attached map.

DATED AND POSTED on the ground this 15 day of April, 2015.

LOCATOR(s)       AGENT

Print Name(s) Entellus, Inc. - Daniel G. Francetic, RLS

Signature(s) *Daniel G. Francetic*

Form MCF100  
Revised July 2014

This form is available from the Arizona Geological Survey and may be reproduced.

AMC 432226



# RED BULL - 582 CLAIM

## LOCATION OF RED BULL-556 THROUGH RED BULL-591 LODE CLAIMS

LOCATED IN SECTIONS 1, 2, 11, 12, T.5S., R.26E. AND SECTIONS 6, & 7, T.5S., R.27E.  
GRAHAM COUNTY, ARIZONA

ALL CLAIMS ARE 1450' IN LENGTH AND  
600' IN WIDTH UNLESS NOTED

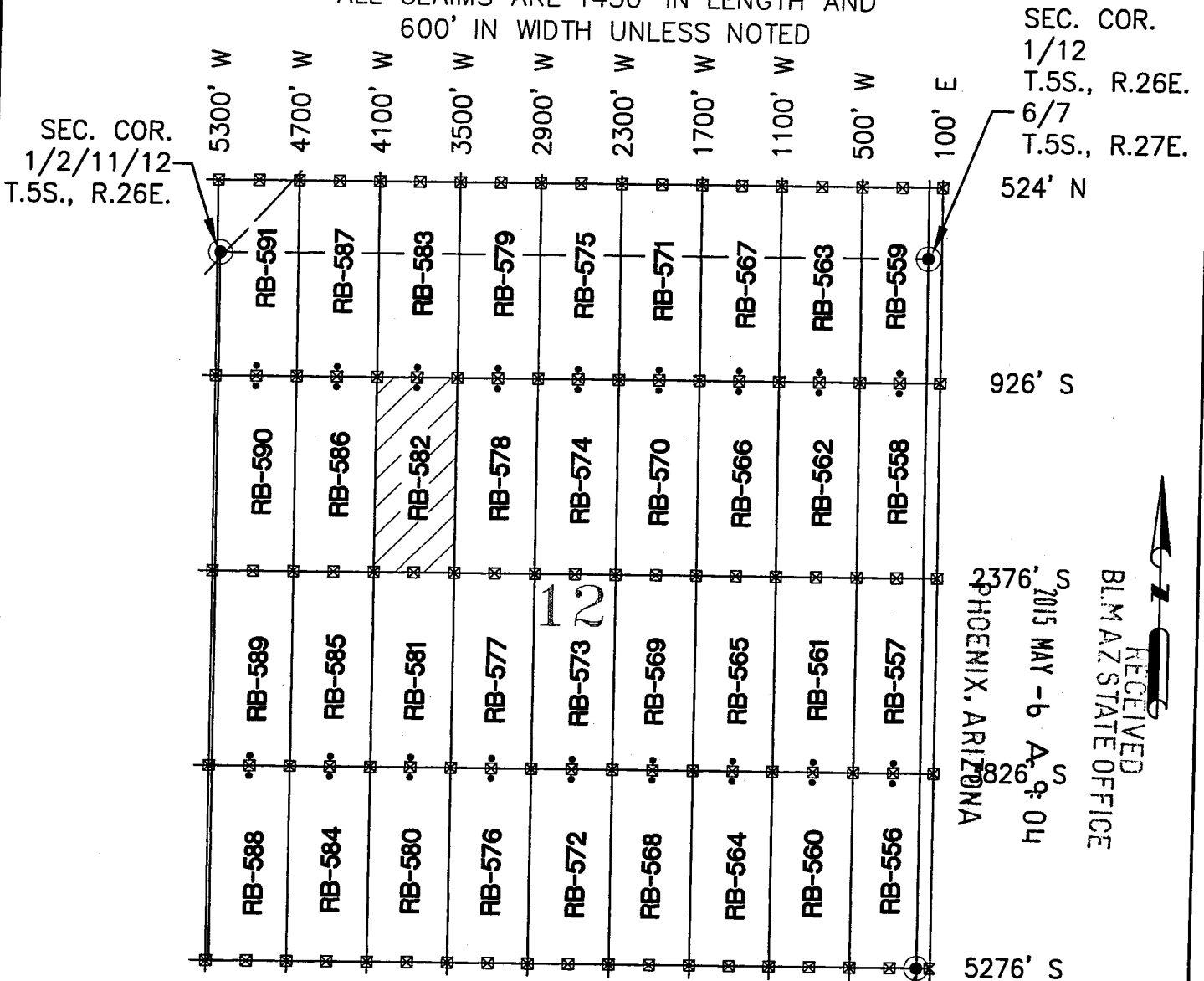

RECEIVED  
BLM AZ STATE OFFICE  
2015 MAY - 6 A.M. 04  
PHOENIX, ARIZONA

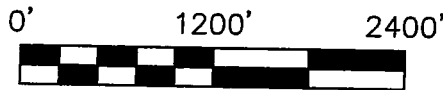
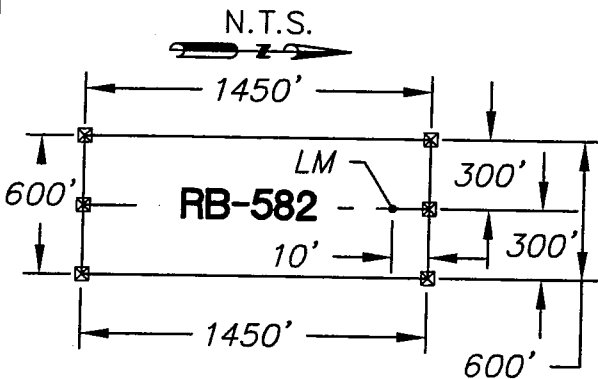

- ☒ INDICATES CORNER OF LODE CLAIM. SET 2"x2"x5' WOODEN POST (TYPICAL)
- INDICATES LOCATION MONUMENT. SET 2"x2"x5' WOODEN POST WITH SIGN (TYPICAL)

CLAIM ACREAGE = 20.0 AC  
WC = WITNESS CORNER NORTH OF SIDE LINE

LOCATORS:  
FREEPORT MINERALS CORP.  
PO BOX 1019  
SAFFORD AZ 85548

**Entellus™**  
2255 N. 44th Street Suite 125  
Phoenix, AZ 85008.3279  
Tel 602.244.2566  
Fax 602.244.8947  
Website: www.Entellus.com

SEC. COR.  
12/13 T.5S., R.26E.  
7/18 T.5S., R.27E.

SEC. COR.  
1/2/11/12  
T.5S., R.26E.

SEC. COR.  
1/12  
T.5S., R.26E.  
6/7  
T.5S., R.27E.

**LOCATION NOTICE FOR LODE MINING CLAIM**

Amendment BLM Serial # \_\_\_\_\_

NOTICE IS HEREBY GIVEN that the Red Bull - 583

\_\_\_\_\_ lode mining claim has been located  
by Freeport Minerals Corporation whose current mailing  
address is P.O. Box 1019  
Safford, Arizona 85548

RECEIVED  
BLM AZ STATE OFFICE  
2015 MAY -6 A 9 04  
PHOENIX, ARIZONA  
Graham

BLM  
Date  
Stamp

The general course of this claim is North to South and it is situated in \_\_\_\_\_  
County, Arizona. This claim is 1450 feet in length and 600 feet in width.

20.0 Total Claim Acreage. This claim runs from the location monument on which this location notice  
is posted on the centerline of the claim approximately 10 feet in a Southerly direction to the South  
end line and 1440 feet in a Northerly direction to the North end line. This claim is marked by six  
monuments, one at each corner and one at the center of each end line of the claim.

The location monument on which this notice is posted is situated within Section 12 Township 5  
S, Range 26 E, Gila Salt River Base and Meridian, Arizona and this claim encompasses portions  
of the following quarter section(s), section(s), Township(s) and Range(s) NW 1/4

Section 12 Township 5S Range 26E SW 1/4 Section 1 Township 5S Range 26E  
Gila Salt River Base and Meridian, Arizona.

The locality of this claim with reference to some natural object or permanent monument and additional information  
(if any) concerning its locality are as follows: The Northeast corner of the claim is 524' North and 3500' West of the monument at the  
Northeast Corner of Section 12, Township 5S, Range 26E

The above information is shown on the attached map.

DATED AND POSTED on the ground this 15 day of April, 2015.

LOCATOR(s)  AGENT

Print Name(s) Entellus, Inc. - Daniel G. Francetic, RLS

Signature(s) *Daniel G. Francetic*

Form MCF100  
Revised July 2014

AMC432227

# RED BULL - 583 CLAIM

## LOCATION OF RED BULL-556 THROUGH RED BULL-591 LODE CLAIMS

LOCATED IN SECTIONS 1, 2, 11, 12, T.5S., R.26E. AND SECTIONS 6, & 7, T.5S., R.27E.  
GRAHAM COUNTY, ARIZONA

ALL CLAIMS ARE 1450' IN LENGTH AND  
600' IN WIDTH UNLESS NOTED

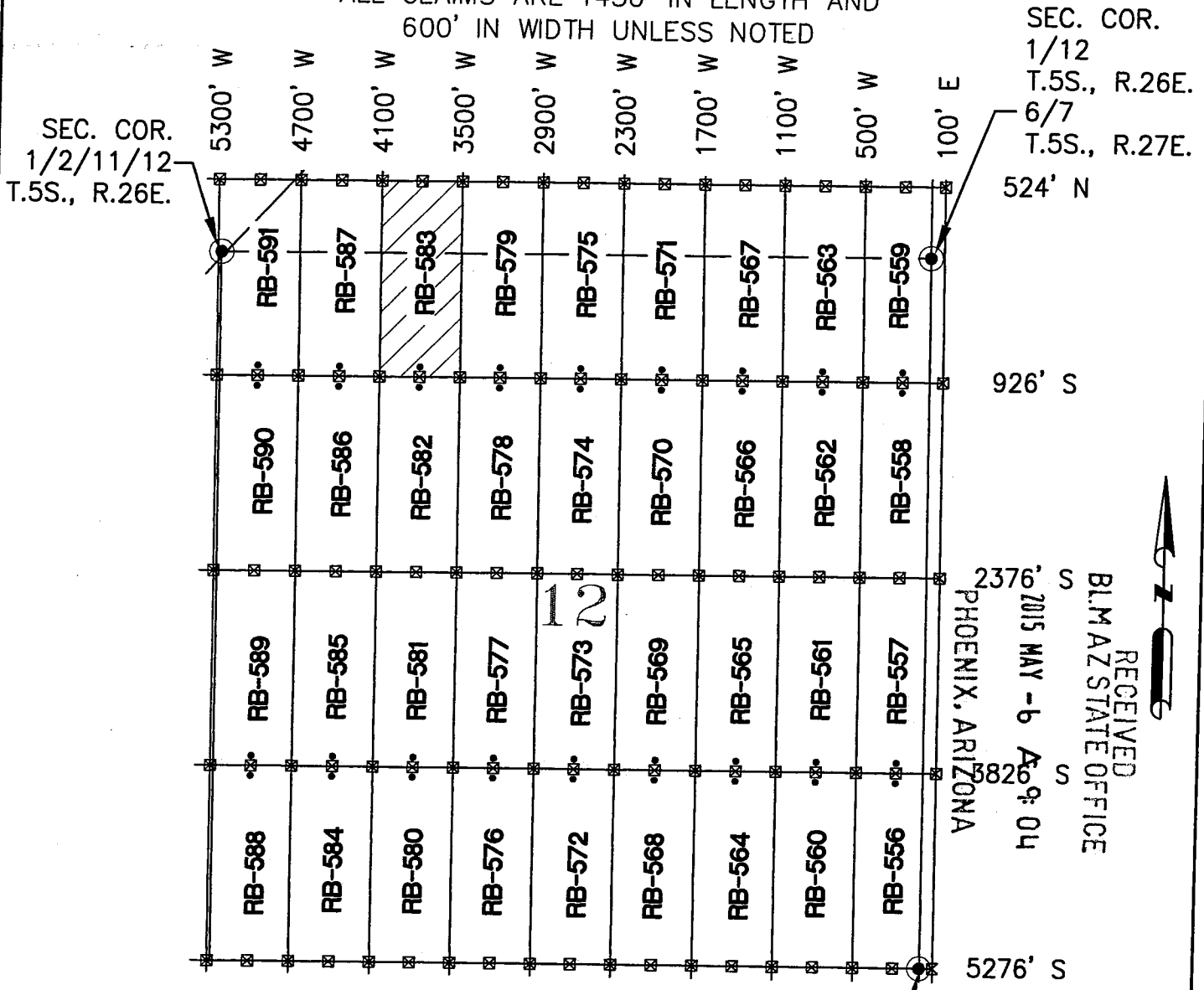

SEC. COR.  
1/12  
T.5S., R.26E.  
6/7  
T.5S., R.27E.

SEC. COR.  
1/2/11/12  
T.5S., R.26E.

RECEIVED  
BLM AZ STATE OFFICE  
PHOENIX, ARIZONA  
MAY - 6 2015  
9:04 AM

SEC. COR.  
12/13 T.5S., R.26E.  
7/18 T.5S., R.27E.

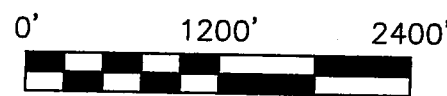
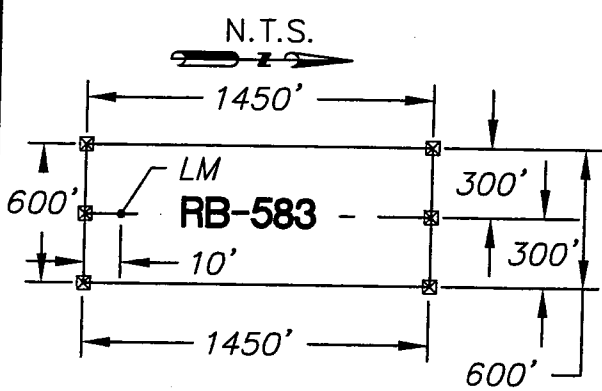

- ☒ INDICATES CORNER OF LODE CLAIM. SET 2"x2"x5' WOODEN POST (TYPICAL)
- INDICATES LOCATION MONUMENT. SET 2"x2"x5' WOODEN POST WITH SIGN (TYPICAL)

LOCATORS:  
FREEPORT MINERALS CORP.  
PO BOX 1019  
SAFFORD AZ 85548

CLAIM ACREAGE = 20.0 AC  
WC = WITNESS CORNER NORTH  
OF SIDE LINE

**Entellus**  
2255 N. 44th Street Suite 125  
Phoenix, AZ 85008.3279  
Tel 602.244.2566  
Fax 602.244.8947  
Website: www.Entellus.com

**LOCATION NOTICE FOR LODE MINING CLAIM**

Amendment BLM Serial # \_\_\_\_\_

NOTICE IS HEREBY GIVEN that the Red Bull - 584

\_\_\_\_\_ lode mining claim has been located

by Freeport Minerals Corporation whose current mailing

address is P.O. Box 1019

Safford, Arizona 85548

The general course of this claim is North to South and it is situated in Graham

County, Arizona. This claim is 1450 feet in length and 600 feet in width.

20.0 Total Claim Acreage. This claim runs from the location monument on which this location notice

is posted on the centerline of the claim approximately 10 feet in a Northerly direction to the North

end line and 1440 feet in a Southerly direction to the South end line. This claim is marked by six monuments, one at each corner and one at the center of each end line of the claim.

The location monument on which this notice is posted is situated within Section 12 Township 5

S, Range 26 E, Gila Salt River Base and Meridian, Arizona and this claim encompasses portions

of the following quarter section(s), section(s), Township(s) and Range(s) SW 1/4

Section 12 Township 5S Range 26E

Gila Salt River Base and Meridian, Arizona.

The locality of this claim with reference to some natural object or permanent monument and additional information

(if any) concerning its locality are as follows: The Northeast corner of the claim is 3826' South and 4100' West of the monument at the

Northeast Corner of Section 12, Township 5S, Range 26E

The above information is shown on the attached map.

DATED AND POSTED on the ground this 14 day of April, 2015

LOCATOR(s)  AGENT

Print Name(s) Entellus, Inc. - Daniel G. Francetic, RLS

Signature(s) *Daniel G. Francetic*

RECEIVED  
BLM AZ STATE OFFICE  
2015 MAY -6 A 9:04  
PHOENIX, ARIZONA  
BLM  
Date  
Stamp

AMC 432228

Form MCF100  
Revised July 2014

# RED BULL - 584 CLAIM

## LOCATION OF RED BULL-556 THROUGH RED BULL-591 LODE CLAIMS

LOCATED IN SECTIONS 1, 2, 11, 12, T.5S., R.26E. AND SECTIONS 6, & 7, T.5S., R.27E.  
GRAHAM COUNTY, ARIZONA

ALL CLAIMS ARE 1450' IN LENGTH AND  
600' IN WIDTH UNLESS NOTED

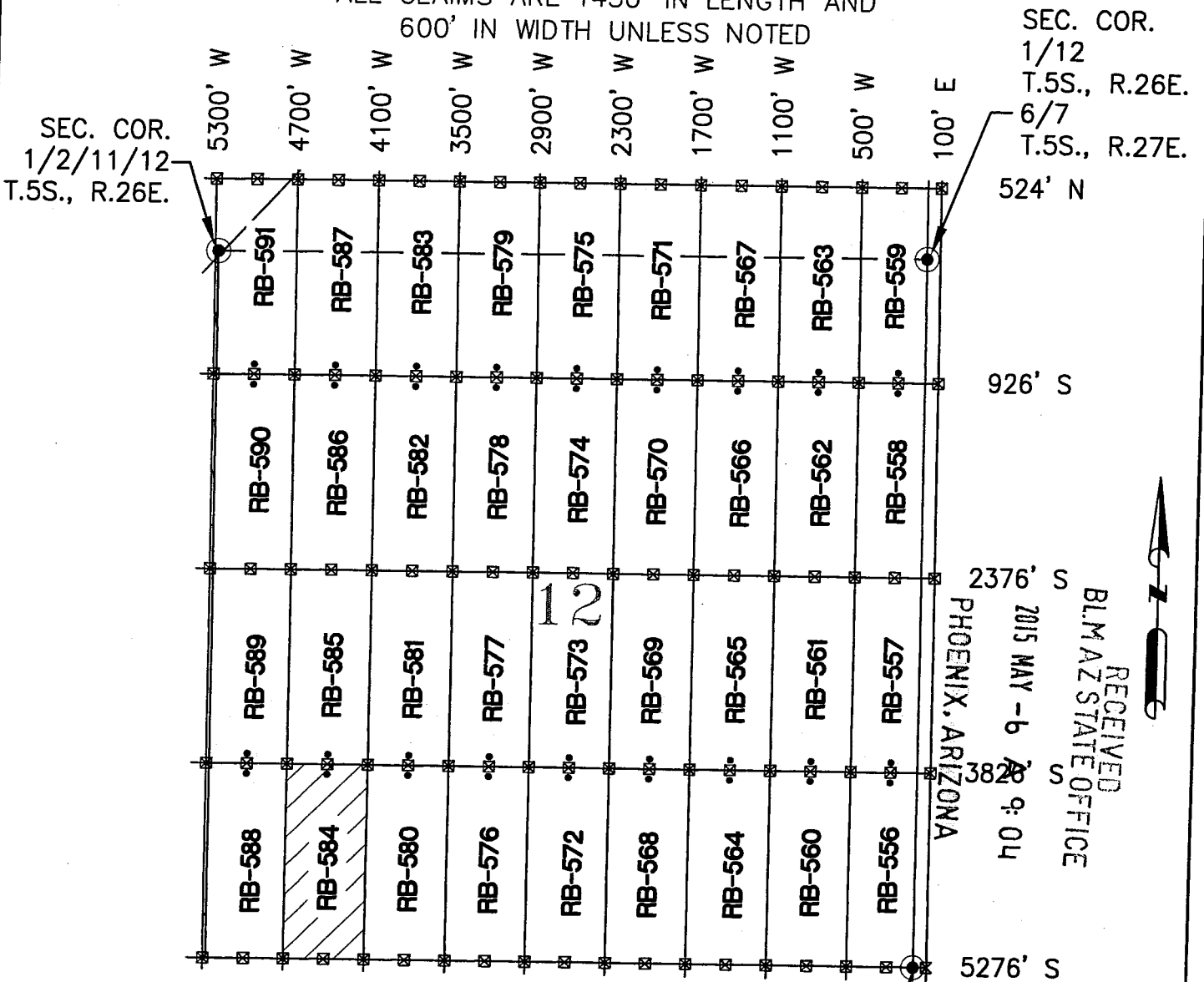

SEC. COR.  
1/12  
T.5S., R.26E.  
6/7  
T.5S., R.27E.  
524' N

SEC. COR.  
1/2/11/12  
T.5S., R.26E.

926' S

2376' S

PHOENIX, ARIZONA

3826' S  
2015 MAY - 6 9:04  
RECEIVED  
BLM AZ STATE OFFICE

5276' S

SEC. COR.  
12/13 T.5S., R.26E.  
7/18 T.5S., R.27E.

N.T.S.

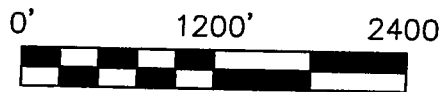
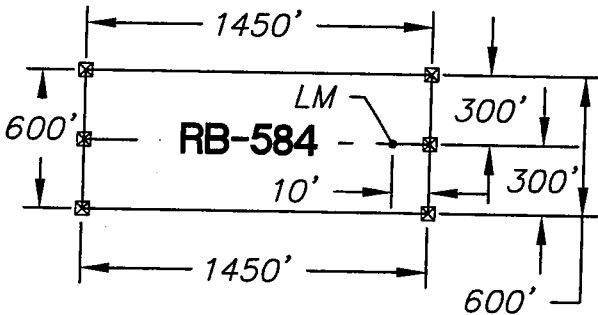

- ☒ INDICATES CORNER OF LODE CLAIM. SET 2"x2"x5' WOODEN POST (TYPICAL)
- INDICATES LOCATION MONUMENT. SET 2"x2"x5' WOODEN POST WITH SIGN (TYPICAL)

LOCATORS:  
FREEPORT MINERALS CORP.  
PO BOX 1019  
SAFFORD AZ 85548

CLAIM ACREAGE = 20.0 AC  
WC = WITNESS CORNER NORTH  
OF SIDE LINE

 **Entellus™**  
2255 N. 44th Street Suite 125  
Phoenix, AZ 85008.3279  
Tel 602.244.2566  
Fax 602.244.8947  
Website: www.Entellus.com

**LOCATION NOTICE FOR LODE MINING CLAIM**

Amendment BLM Serial # \_\_\_\_\_

NOTICE IS HEREBY GIVEN that the Red Bull - 585

\_\_\_\_\_ lode mining claim has been located

by Freeport Minerals Corporation whose current mailing

address is P.O. Box 1019

Safford, Arizona 85548

The general course of this claim is North to South and it is situated in \_\_\_\_\_

County, Arizona. This claim is 1450 feet in length and 600 feet in width.

20.0 Total Claim Acreage. This claim runs from the location monument on which this location notice

is posted on the centerline of the claim approximately 10 feet in a Southerly direction to the South

end line and 1440 feet in a Northerly direction to the North end line. This claim is marked by six

monuments, one at each corner and one at the center of each end line of the claim.

The location monument on which this notice is posted is situated within Section 12 Township 5

S, Range 26 E, Gila Salt River Base and Meridian, Arizona and this claim encompasses portions

of the following quarter section(s), section(s), Township(s) and Range(s) SW 1/4 NW 1/4

Section 12 Township 5S Range 26E

Gila Salt River Base and Meridian, Arizona.

The locality of this claim with reference to some natural object or permanent monument and additional information

(if any) concerning its locality are as follows: The Northeast corner of the claim is 2376' South and 4100' West of the monument at the

Northeast Corner of Section 12, Township 5S, Range 26E

The above information is shown on the attached map.

DATED AND POSTED on the ground this 14 day of April, 2015

LOCATOR(s)  AGENT

Print Name(s) Entellus, Inc. - Daniel G. Francetic, RLS

Signature(s) *Daniel G. Francetic*

RECEIVED  
BLM AZ STATE OFFICE  
2015 MAY -6 A 9:04  
PHOENIX, ARIZONA  
Graham  
BLM  
Date  
Stamp

AMC 432229

# RED BULL - 585 CLAIM

## LOCATION OF RED BULL-585 THROUGH RED BULL-591 LODE CLAIMS

LOCATED IN SECTIONS 1, 2, 11, 12, T.5S., R.26E. AND SECTIONS 6, & 7, T.5S., R.27E.  
GRAHAM COUNTY, ARIZONA

ALL CLAIMS ARE 1450' IN LENGTH AND  
600' IN WIDTH UNLESS NOTED

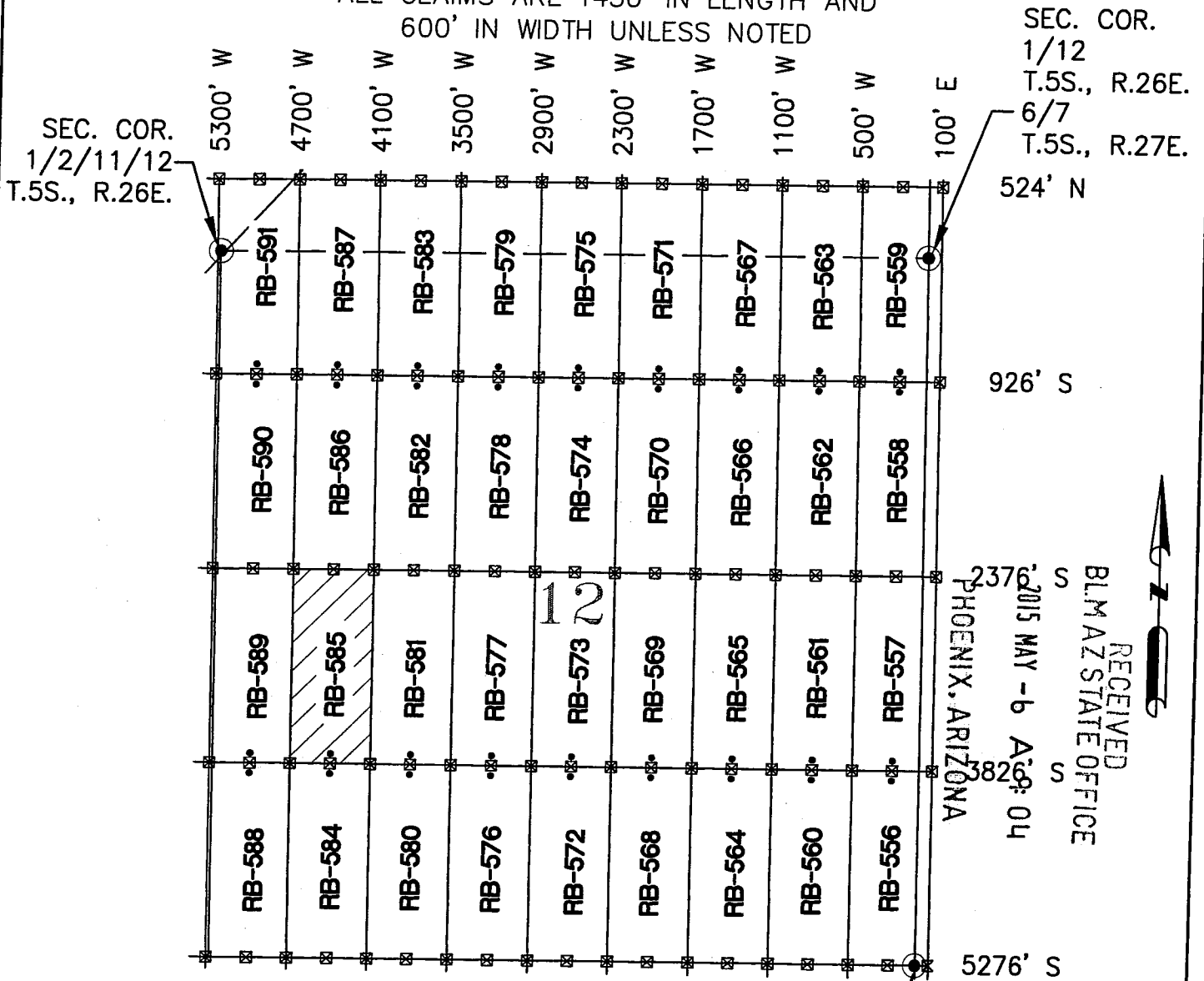

RECEIVED  
BLM AZ STATE OFFICE  
PHOENIX, ARIZONA  
MAY - 6 2015  
8:04 AM

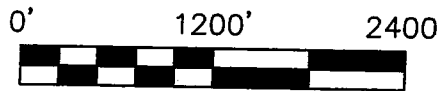
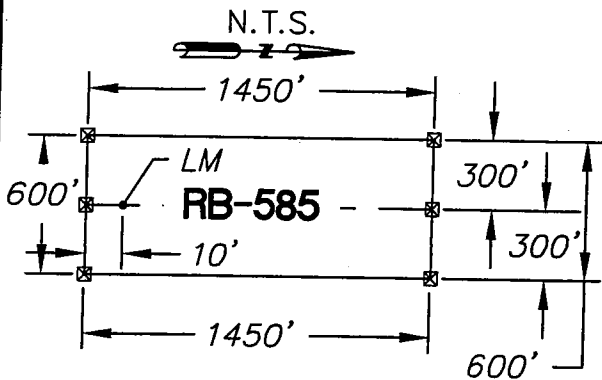

- ☒ INDICATES CORNER OF LODE CLAIM. SET 2"x2"x5' WOODEN POST (TYPICAL)
- INDICATES LOCATION MONUMENT. SET 2"x2"x5' WOODEN POST WITH SIGN (TYPICAL)

LOCATORS:  
FREEPORT MINERALS CORP.  
PO BOX 1019  
SAFFORD AZ 85548

CLAIM ACREAGE = 20.0 AC  
WC = WITNESS CORNER NORTH  
OF SIDE LINE

 **Entellus™**  
2255 N. 44th Street Suite 125  
Phoenix, AZ 85008.3279  
Tel 602.244.2566  
Fax 602.244.8947  
Website: www.Entellus.com

**LOCATION NOTICE FOR LODE MINING CLAIM**

Amendment BLM Serial # \_\_\_\_\_

NOTICE IS HEREBY GIVEN that the Red Bull - 586

\_\_\_\_\_ lode mining claim has been located

by Freeport Minerals Corporation whose current mailing

address is P.O. Box 1019

Safford, Arizona 85548

The general course of this claim is North to South and it is situated in Graham

County, Arizona. This claim is 1450 feet in length and 600 feet in width.

20.0 Total Claim Acreage. This claim runs from the location monument on which this location notice is posted on the centerline of the claim approximately 10 feet in a Northerly direction to the North

end line and 1440 feet in a Southerly direction to the South end line. This claim is marked by six monuments, one at each corner and one at the center of each end line of the claim.

The location monument on which this notice is posted is situated within Section 12 Township 5

S, Range 26 E, Gila Salt River Base and Meridian, Arizona and this claim encompasses portions

of the following quarter section(s), section(s), Township(s) and Range(s) NW 1/4

Section 12 Township 5S Range 26E

Gila Salt River Base and Meridian, Arizona.

The locality of this claim with reference to some natural object or permanent monument and additional information

(if any) concerning its locality are as follows: The Northeast corner of the claim is 926' South and 4100' West of the monument at the Northeast Corner of Section 12, Township 5S, Range 26E

The above information is shown on the attached map.

DATED AND POSTED on the ground this 15 day of April, 2015

LOCATOR(s)  AGENT

Print Name(s) Entellus, Inc. - Daniel G. Francetic, RLS

Signature(s) *Daniel G. Francetic*

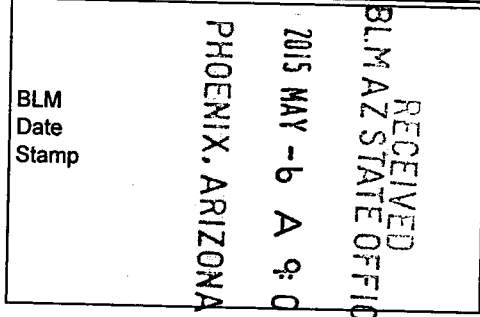

AMC432230

Form MCF100 Revised July 2014



# RED BULL - 586 CLAIM

## LOCATION OF RED BULL-556 THROUGH RED BULL-591 LODE CLAIMS

LOCATED IN SECTIONS 1, 2, 11, 12, T.5S., R.26E. AND SECTIONS 6, & 7, T.5S., R.27E.  
GRAHAM COUNTY, ARIZONA

ALL CLAIMS ARE 1450' IN LENGTH AND  
600' IN WIDTH UNLESS NOTED

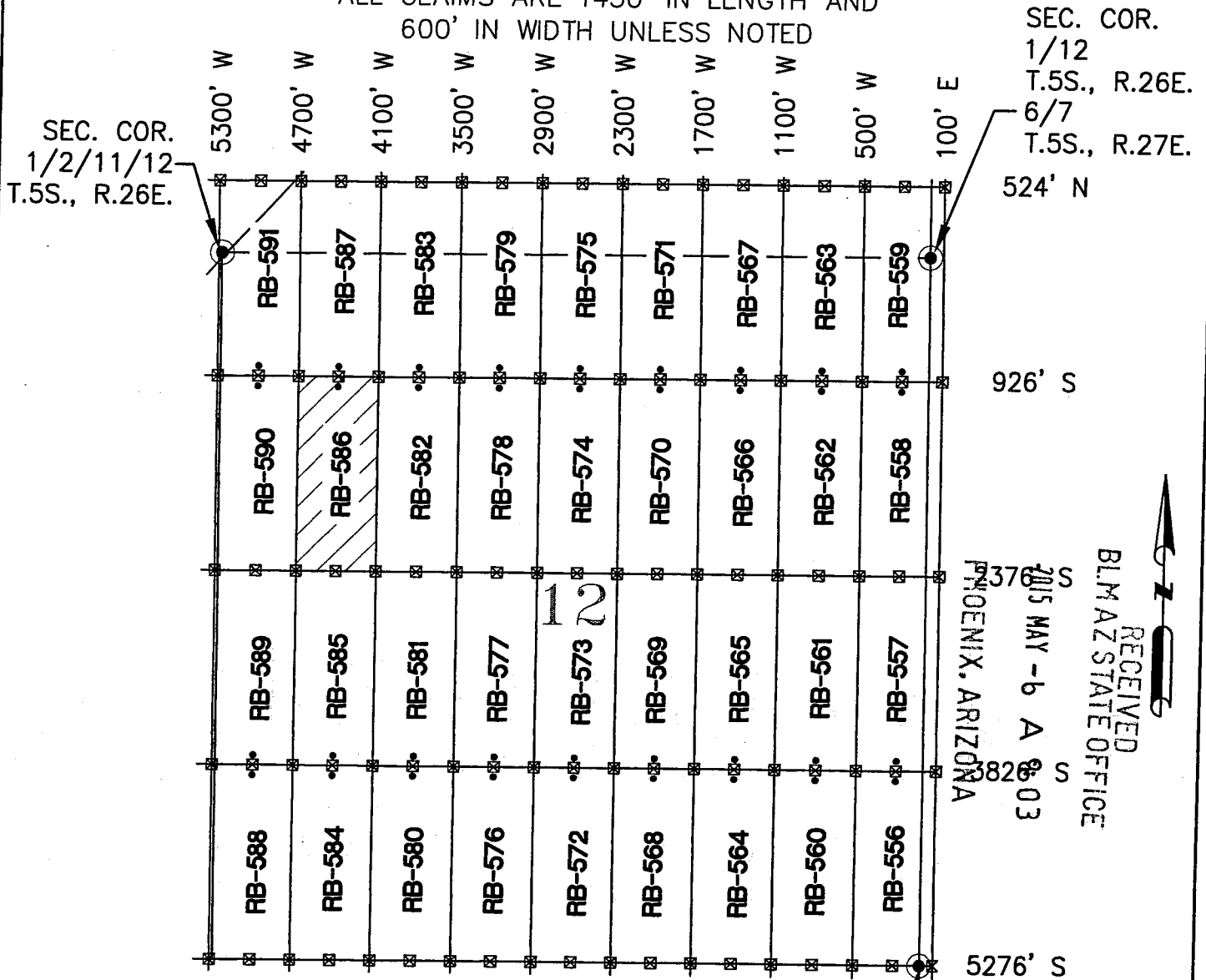

RECEIVED  
BLM AZ STATE OFFICE  
PHOENIX, ARIZONA  
MAY - 6 2015  
8:03

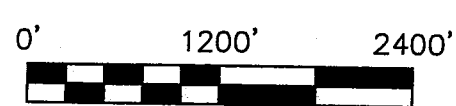
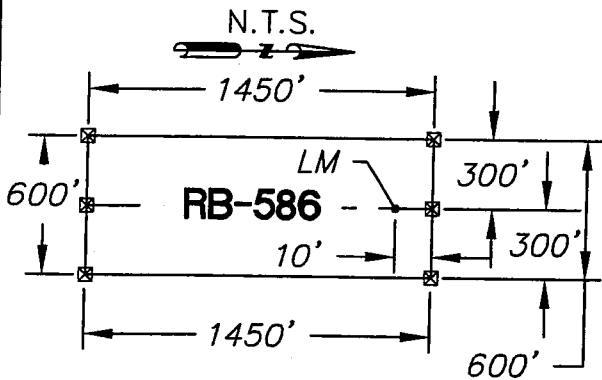

- ☒ INDICATES CORNER OF LODE CLAIM. SET 2"x2"x5' WOODEN POST (TYPICAL)
- INDICATES LOCATION MONUMENT. SET 2"x2"x5' WOODEN POST WITH SIGN (TYPICAL)

SEC. COR.  
12/13 T.5S., R.26E.  
7/18 T.5S., R.27E.

LOCATORS:  
FREEPORT MINERALS CORP.  
PO BOX 1019  
SAFFORD AZ 85548

CLAIM ACREAGE = 20.0 AC  
WC = WITNESS CORNER NORTH  
OF SIDE LINE

**Entellus™**  
2255 N. 44th Street Suite 125  
Phoenix, AZ 85008.3279  
Tel 602.244.2566  
Fax 602.244.8947  
Website: www.Entellus.com

**LOCATION NOTICE FOR LODE MINING CLAIM**

Amendment BLM Serial # \_\_\_\_\_

NOTICE IS HEREBY GIVEN that the Red Bull - 587

\_\_\_\_\_ lode mining claim has been located

by Freeport Minerals Corporation whose current mailing

address is P.O. Box 1019

Safford, Arizona 85548

The general course of this claim is North to South and it is situated in Graham

County, Arizona. This claim is 1450 feet in length and 600 feet in width.

20.0 Total Claim Acreage. This claim runs from the location monument on which this location notice

is posted on the centerline of the claim approximately 10 feet in a Southerly direction to the South

end line and 1440 feet in a Northerly direction to the North end line. This claim is marked by six monuments, one at each corner and one at the center of each end line of the claim.

The location monument on which this notice is posted is situated within Section 12 Township 5

S, Range 26 E, Gila Salt River Base and Meridian, Arizona and this claim encompasses portions

of the following quarter section(s), section(s), Township(s) and Range(s) NW 1/4

Section 12 Township 5S Range 26E SW 1/4 Section 1 Township 5S Range 26E

Gila Salt River Base and Meridian, Arizona.

The locality of this claim with reference to some natural object or permanent monument and additional information

(if any) concerning its locality are as follows: The Northeast corner of the claim is 524' North and 4100' West of the monument at the

Northeast Corner of Section 12, Township 5S, Range 26E

The above information is shown on the attached map.

DATED AND POSTED on the ground this 15 day of April, 2015

LOCATOR(s)  AGENT

Print Name(s) Entellus, Inc. - Daniel G. Francetic, RLS

Signature(s) *Daniel G. Francetic*

RECEIVED  
BLM AZ STATE OFFICE  
2015 MAY -6 A 9:03  
PHOENIX, ARIZONA  
BLM  
Date  
Stamp

AMC432231

Form MCF100  
Revised July 2014

# RED BULL - 587 CLAIM

## LOCATION OF RED BULL-556 THROUGH RED BULL-591 LODE CLAIMS

LOCATED IN SECTIONS 1, 2, 11, 12, T.5S., R.26E. AND SECTIONS 6, & 7, T.5S., R.27E.  
GRAHAM COUNTY, ARIZONA

ALL CLAIMS ARE 1450' IN LENGTH AND  
600' IN WIDTH UNLESS NOTED

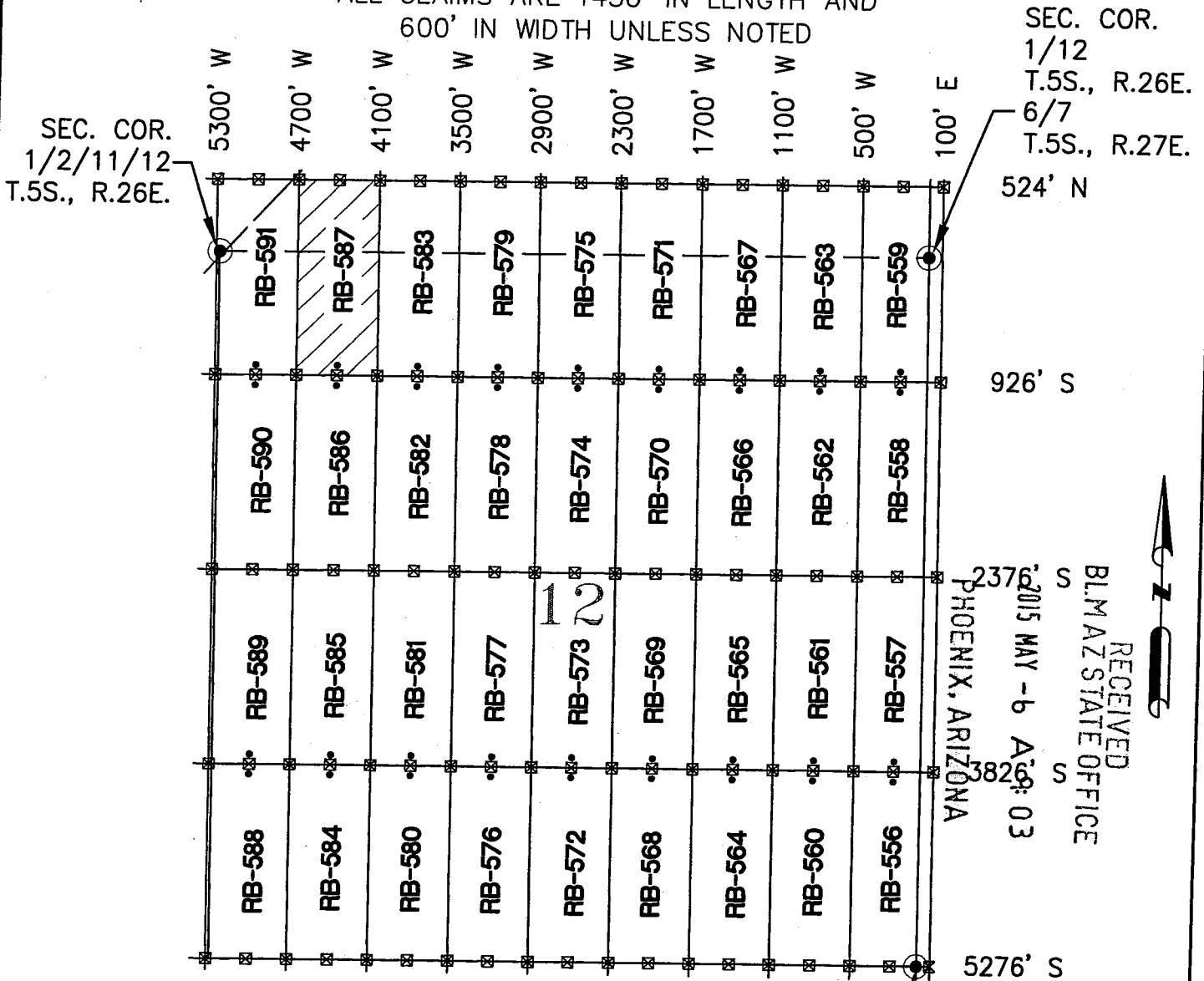

SEC. COR.  
1/12  
T.5S., R.26E.  
6/7  
T.5S., R.27E.

RECEIVED  
BLM AZ STATE OFFICE  
2015 MAY -6 A 8:03  
PHOENIX, ARIZONA



N.T.S.

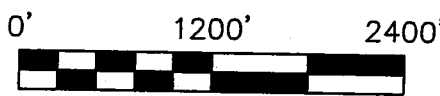
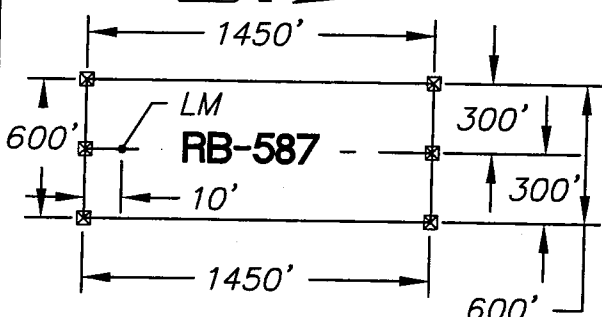

- ☒ INDICATES CORNER OF LODE CLAIM. SET 2"x2"x5' WOODEN POST (TYPICAL)
- INDICATES LOCATION MONUMENT. SET 2"x2"x5' WOODEN POST WITH SIGN (TYPICAL)

SEC. COR.  
12/13 T.5S., R.26E.  
7/18 T.5S., R.27E.

LOCATORS:  
FREEPORT MINERALS CORP.  
PO BOX 1019  
SAFFORD AZ 85548

CLAIM ACREAGE = 20.0 AC  
WC = WITNESS CORNER NORTH  
OF SIDE LINE

**Entellus**  
2255 N. 44th Street Suite 125  
Phoenix, AZ 85008.3279  
Tel 602.244.2566  
Fax 602.244.8947  
Website: www.Entellus.com

**LOCATION NOTICE FOR LODE MINING CLAIM**

Amendment BLM Serial # \_\_\_\_\_

NOTICE IS HEREBY GIVEN that the Red Bull - 588

\_\_\_\_\_ lode mining claim has been located

by Freeport Minerals Corporation whose current mailing

address is P.O. Box 1019

Safford, Arizona 85548

The general course of this claim is North to South and it is situated in Graham

County, Arizona. This claim is 1450 feet in length and 600 feet in width.

20.0 Total Claim Acreage. This claim runs from the location monument on which this location notice

is posted on the centerline of the claim approximately 10 feet in a Northerly direction to the North

end line and 1440 feet in a Southerly direction to the South end line. This claim is marked by six

monuments, one at each corner and one at the center of each end line of the claim.

The location monument on which this notice is posted is situated within Section 12 Township 5

S, Range 26 E, Gila Salt River Base and Meridian, Arizona and this claim encompasses portions

of the following quarter section(s), section(s), Township(s) and Range(s) SW 1/4

Section 12 Township 5S Range 26E and SE 1/4 Section 11 Township 5S Range 26E

Gila Salt River Base and Meridian, Arizona.

The locality of this claim with reference to some natural object or permanent monument and additional information

(if any) concerning its locality are as follows: The Northeast corner of the claim is 3826' South and 4700' West of the monument at the

Northeast Corner of Section 12, Township 5S, Range 26E

The above information is shown on the attached map.

DATED AND POSTED on the ground this 14 day of April, 2015

LOCATOR(s)  AGENT

Print Name(s) Entellus, Inc. - Daniel G. Francetic, RLS

Signature(s) *Daniel G. Francetic*

RECEIVED  
BLM AZ STATE OFFICE  
2015 MAY -6 A 9:03  
PHOENIX, ARIZONA  
BLM  
Date  
Stamp

AMC 432232

# RED BULL - 588 CLAIM

## LOCATION OF RED BULL-556 THROUGH RED BULL-591 LODE CLAIMS

LOCATED IN SECTIONS 1, 2, 11, 12, T.5S., R.26E. AND SECTIONS 6, & 7, T.5S., R.27E.  
GRAHAM COUNTY, ARIZONA

ALL CLAIMS ARE 1450' IN LENGTH AND  
600' IN WIDTH UNLESS NOTED

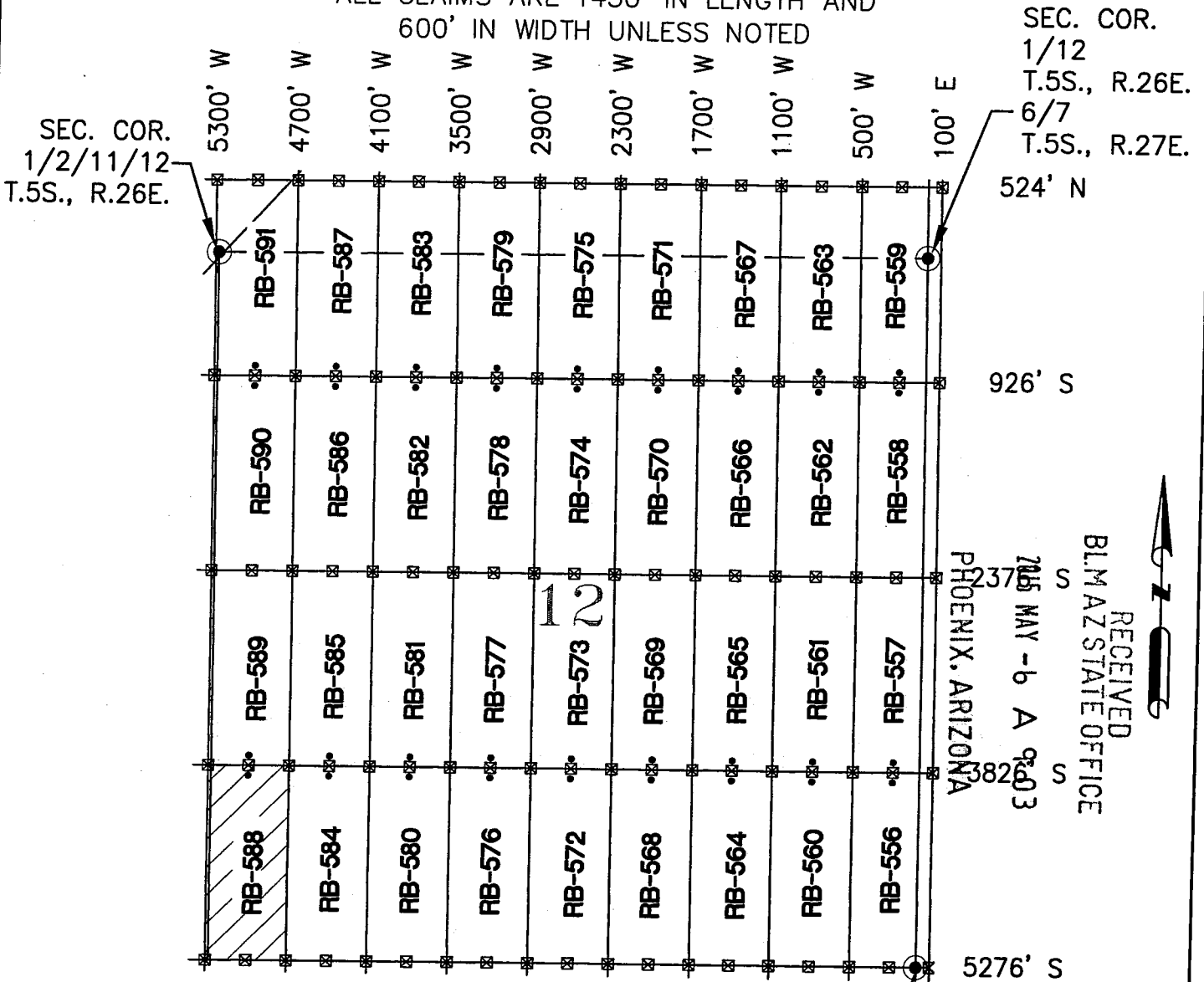

RECEIVED  
BLM AZ STATE OFFICE  
MAY - 6 A 9:03  
PHOENIX, ARIZONA

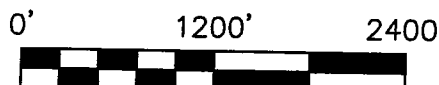
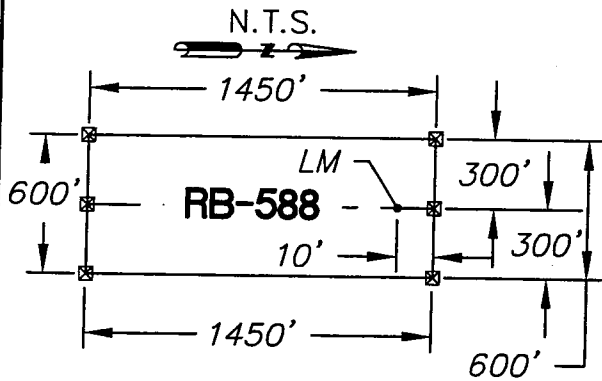

- ☒ INDICATES CORNER OF LODE CLAIM. SET 2"x2"x5' WOODEN POST (TYPICAL)
- INDICATES LOCATION MONUMENT. SET 2"x2"x5' WOODEN POST WITH SIGN (TYPICAL)

SEC. COR.  
12/13 T.5S., R.26E.  
7/18 T.5S., R.27E.

LOCATORS:  
FREEMPORT MINERALS CORP.  
PO BOX 1019  
SAFFORD AZ 85548

CLAIM ACREAGE = 20.0 AC  
WC = WITNESS CORNER NORTH  
OF SIDE LINE

**Entellus™**  
2255 N. 44th Street Suite 125  
Phoenix, AZ 85008.3279  
Tel 602.244.2566  
Fax 602.244.8947  
Website: www.Entellus.com

**LOCATION NOTICE FOR LODE MINING CLAIM**

Amendment BLM Serial # \_\_\_\_\_

NOTICE IS HEREBY GIVEN that the Red Bull - 589

\_\_\_\_\_ lode mining claim has been located

by Freeport Minerals Corporation whose current mailing

address is P.O. Box 1019

Safford, Arizona 85548

The general course of this claim is North to South and it is situated in \_\_\_\_\_ Graham

County, Arizona. This claim is 1450 feet in length and 600 feet in width.

20.0 Total Claim Acreage. This claim runs from the location monument on which this location notice

is posted on the centerline of the claim approximately 10 feet in a Southerly direction to the South

end line and 1440 feet in a Northerly direction to the North end line. This claim is marked by six monuments, one at each corner and one at the center of each end line of the claim.

The location monument on which this notice is posted is situated within Section 12 Township 5

S, Range 26 E, Gila Salt River Base and Meridian, Arizona and this claim encompasses portions

of the following quarter section(s), section(s), Township(s) and Range(s) SW 1/4 NW 1/4

Section 12 Township 5S Range 26E and SE 1/4 NE 1/4 Section 11 Township 5S Range 26E

Gila Salt River Base and Meridian, Arizona.

The locality of this claim with reference to some natural object or permanent monument and additional information

(if any) concerning its locality are as follows: The Northeast corner of the claim is 2376' South and 4700' West of the monument at the Northeast Corner of Section 12, Township 5S, Range 26E

The above information is shown on the attached map.

DATED AND POSTED on the ground this 14 day of April, 2015

LOCATOR(s)  AGENT

Print Name(s) Entellus, Inc. - Daniel G. Francetic, RLS

Signature(s) *Daniel G. Francetic*

RECEIVED  
BLM AZ STATE OFFICE  
2015 MAY -6 A 9:03  
PHOENIX, ARIZONA  
BLM  
Date  
Stamp

AMC432233

# RED BULL - 589 CLAIM

## LOCATION OF RED BULL-556 THROUGH RED BULL-591 LODE CLAIMS

LOCATED IN SECTIONS 1, 2, 11, 12, T.5S., R.26E. AND SECTIONS 6, & 7, T.5S., R.27E.  
GRAHAM COUNTY, ARIZONA

ALL CLAIMS ARE 1450' IN LENGTH AND  
600' IN WIDTH UNLESS NOTED

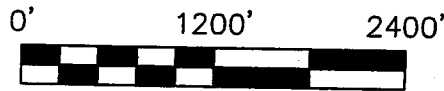
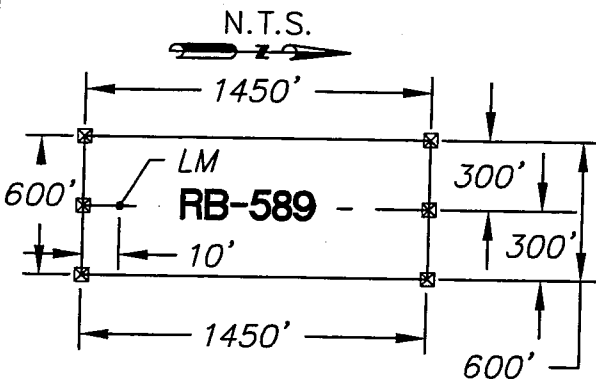
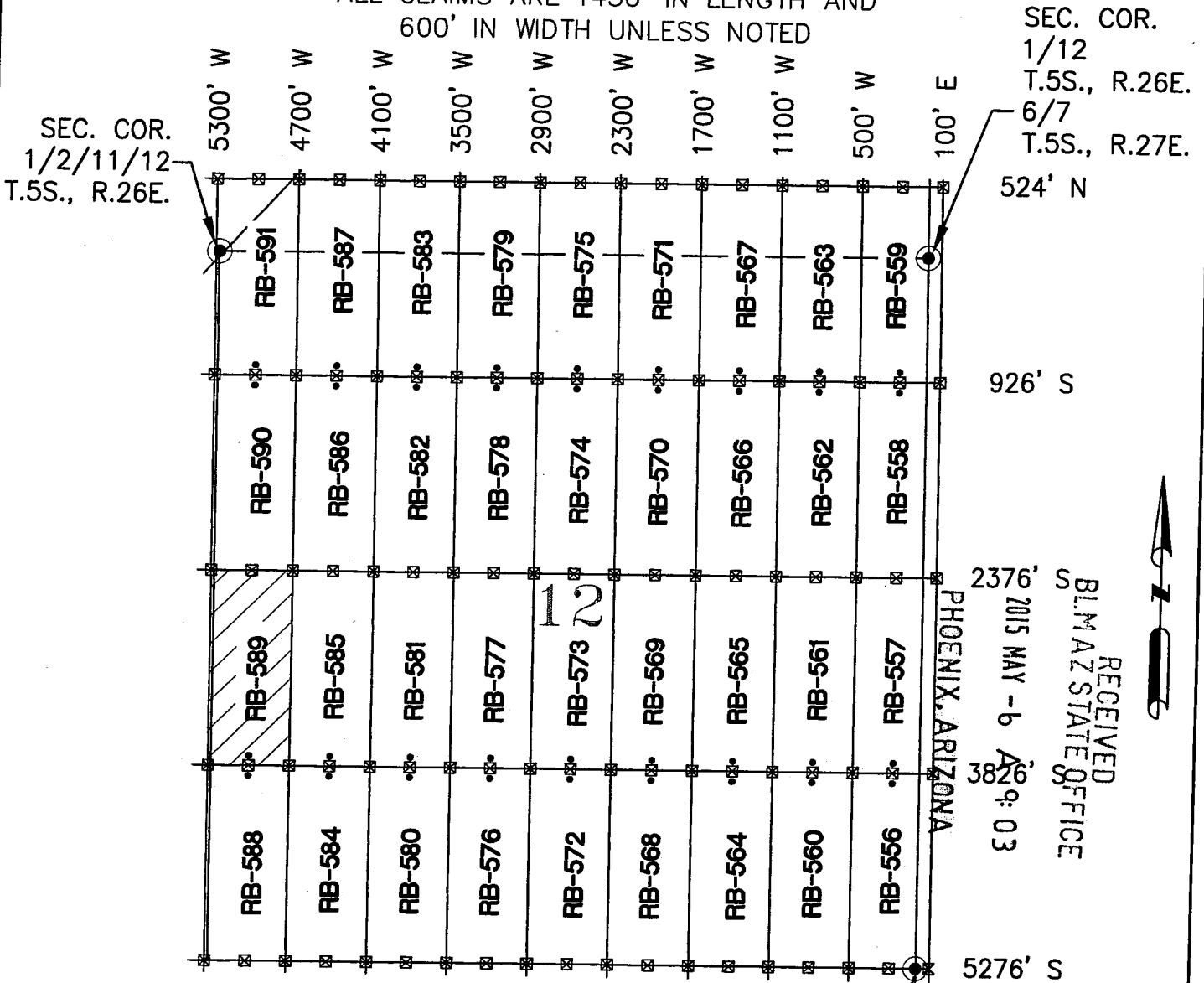

- ☒ INDICATES CORNER OF LODE CLAIM. SET 2"x2"x5' WOODEN POST (TYPICAL)
- INDICATES LOCATION MONUMENT. SET 2"x2"x5' WOODEN POST WITH SIGN (TYPICAL)

CLAIM ACREAGE = 20.0 AC  
WC = WITNESS CORNER NORTH OF SIDE LINE

LOCATORS:  
FREEPORT MINERALS CORP.  
PO BOX 1019  
SAFFORD AZ 85548

**Entellus**  
2255 N. 44th Street Suite 125  
Phoenix, AZ 85008.3279  
Tel 602.244.2566  
Fax 602.244.8947  
Website: www.Entellus.com

RECEIVED  
BLM AZ STATE OFFICE  
2015 MAY - 6 AM 9:03  
PHOENIX, ARIZONA

SEC. COR.  
12/13 T.5S., R.26E.  
7/18 T.5S., R.27E.

**LOCATION NOTICE FOR LODE MINING CLAIM**

Amendment BLM Serial # \_\_\_\_\_

NOTICE IS HEREBY GIVEN that the Red Bull - 590

\_\_\_\_\_ lode mining claim has been located

by Freeport Minerals Corporation whose current mailing

address is P.O. Box 1019

Safford, Arizona 85548

RECEIVED  
BLM AZ STATE OFFICE  
2015 MAY -6 A 9:03  
PHOENIX, ARIZONA

BLM  
Date  
Stamp

The general course of this claim is North to South and it is situated in Graham

County, Arizona. This claim is 1450 feet in length and 600 feet in width.

20.0 Total Claim Acreage. This claim runs from the location monument on which this location notice

is posted on the centerline of the claim approximately 10 feet in a Northerly direction to the North

end line and 1440 feet in a Southerly direction to the South end line. This claim is marked by six monuments, one at each corner and one at the center of each end line of the claim.

The location monument on which this notice is posted is situated within Section 12 Township 5

S, Range 26 E, Gila Salt River Base and Meridian, Arizona and this claim encompasses portions

of the following quarter section(s), section(s), Township(s) and Range(s) NW 1/4

Section 12 Township 5S Range 26E and NE 1/4 Section 11 Township 5S Range 26E

Gila Salt River Base and Meridian, Arizona.

The locality of this claim with reference to some natural object or permanent monument and additional information

(if any) concerning its locality are as follows: The Northeast corner of the claim is 926' South and 4700' West of the monument at the Northeast Corner of Section 12, Township 5S, Range 26E

The above information is shown on the attached map.

DATED AND POSTED on the ground this 15 day of April, 2015

LOCATOR(s)  AGENT

Print Name(s) Entellus, Inc. - Daniel G. Francetic, RLS

Signature(s) *Daniel G. Francetic*

AHC432234

Form MCF100  
Revised July 2014



# RED BULL - 590 CLAIM

## LOCATION OF RED BULL-556 THROUGH RED BULL-591 LODE CLAIMS

LOCATED IN SECTIONS 1, 2, 11, 12, T.5S., R.26E. AND SECTIONS 6, & 7, T.5S., R.27E.  
GRAHAM COUNTY, ARIZONA

ALL CLAIMS ARE 1450' IN LENGTH AND  
600' IN WIDTH UNLESS NOTED

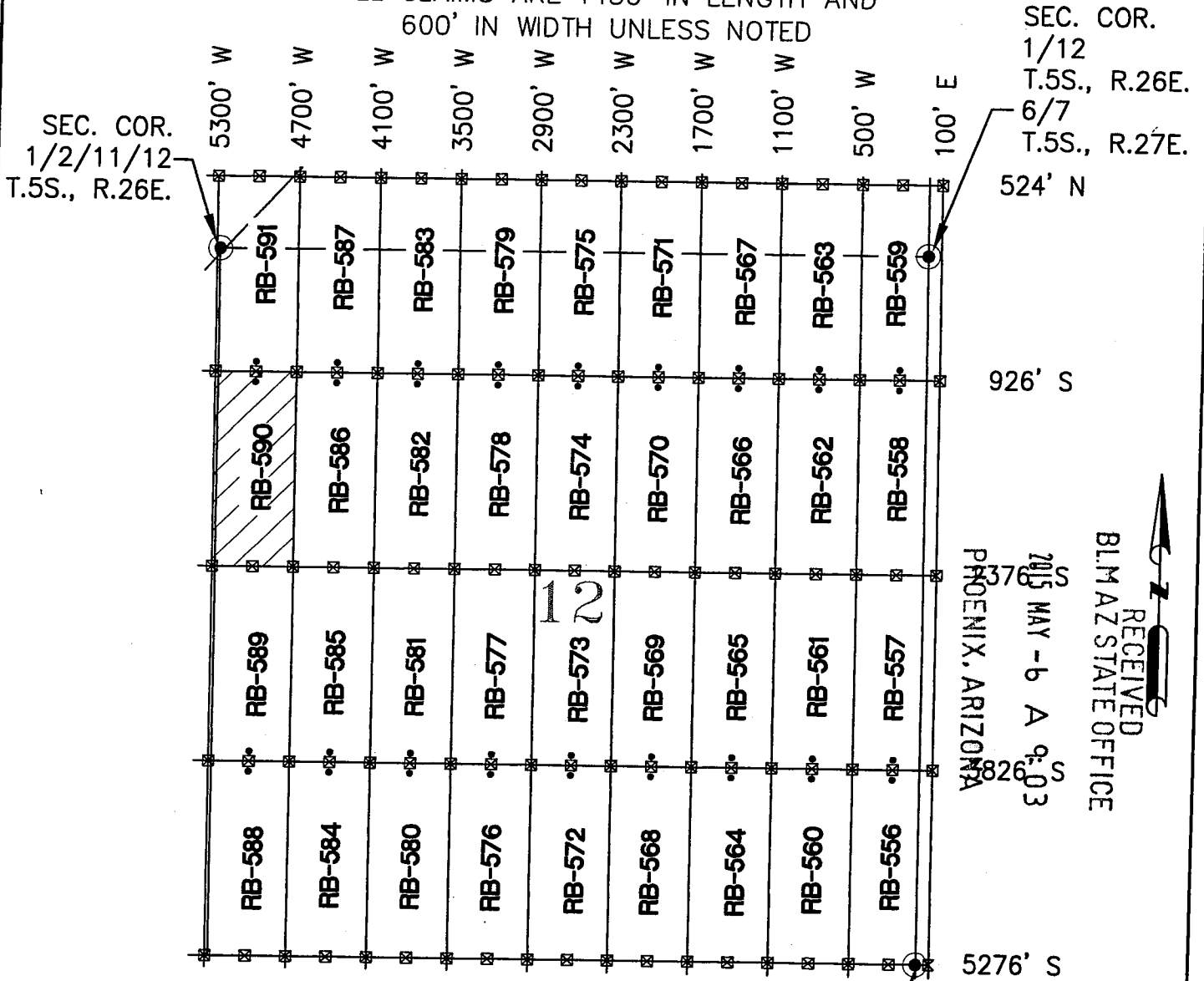

RECEIVED  
BLM AZ STATE OFFICE  
PHOENIX, ARIZONA  
MAY - 6 A 9:03  
2015

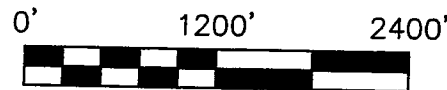
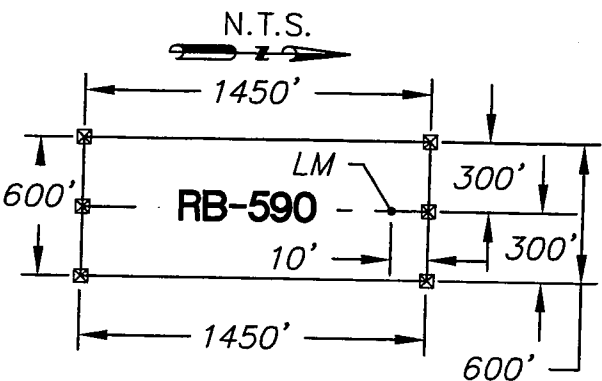

- ☒ INDICATES CORNER OF LODE CLAIM. SET 2"x2"x5' WOODEN POST (TYPICAL)
- INDICATES LOCATION MONUMENT. SET 2"x2"x5' WOODEN POST WITH SIGN (TYPICAL)

LOCATORS:  
FREEPORT MINERALS CORP.  
PO BOX 1019  
SAFFORD AZ 85548

CLAIM ACREAGE = 20.0 AC  
WC = WITNESS CORNER NORTH  
OF SIDE LINE

**Entellus™**  
2255 N. 44th Street Suite 125  
Phoenix, AZ 85008.3279  
Tel 602.244.2566  
Fax 602.244.8947  
Website: www.Entellus.com

SEC. COR.  
12/13 T.5S., R.26E.  
7/18 T.5S., R.27E.

**LOCATION NOTICE FOR LODE MINING CLAIM**

Amendment BLM Serial # \_\_\_\_\_

NOTICE IS HEREBY GIVEN that the Red Bull - 591

\_\_\_\_\_ lode mining claim has been located

by Freeport Minerals Corporation whose current mailing

address is P.O. Box 1019

Safford, Arizona 85548

RECEIVED  
BLM AZ STATE OFFICE  
2015 MAY -6 A 9:03  
PHOENIX, ARIZONA  
BLM  
Date  
Stamp

The general course of this claim is North to South and it is situated in Graham

County, Arizona. This claim is 1450 feet in length and 600 feet in width.

20.0 Total Claim Acreage. This claim runs from the location monument on which this location notice

is posted on the centerline of the claim approximately 10 feet in a Southerly direction to the South

end line and 1440 feet in a Northerly direction to the North end line. This claim is marked by six

monuments, one at each corner and one at the center of each end line of the claim.

The location monument on which this notice is posted is situated within Section 12 Township 5

S, Range 26 E, Gila Salt River Base and Meridian, Arizona and this claim encompasses portions

of the following quarter section(s), section(s), Township(s) and Range(s) NW 1/4 Section 12

SW 1/4 Section 1, NE 1/4 Section 11, SE 1/4 Section 2 Township 5S Range 26E

Gila Salt River Base and Meridian, Arizona.

The locality of this claim with reference to some natural object or permanent monument and additional information

(if any) concerning its locality are as follows: The Northeast corner of the claim is 524' North and 4700' West of the monument at the

Northeast Corner of Section 12, Township 5S, Range 26E

The above information is shown on the attached map.

DATED AND POSTED on the ground this 15 day of April, 2015

LOCATOR(s)  AGENT

Print Name(s) Entellus, Inc. - Daniel G. Francetic, RLS

Signature(s) *Daniel G. Francetic*

AMC 432235

Form MCF100  
Revised July 2014

# RED BULL - 591 CLAIM

## LOCATION OF RED BULL-556 THROUGH RED BULL-591 LODE CLAIMS

LOCATED IN SECTIONS 1, 2, 11, 12, T.5S., R.26E. AND SECTIONS 6, & 7, T.5S., R.27E.  
GRAHAM COUNTY, ARIZONA

ALL CLAIMS ARE 1450' IN LENGTH AND  
600' IN WIDTH UNLESS NOTED

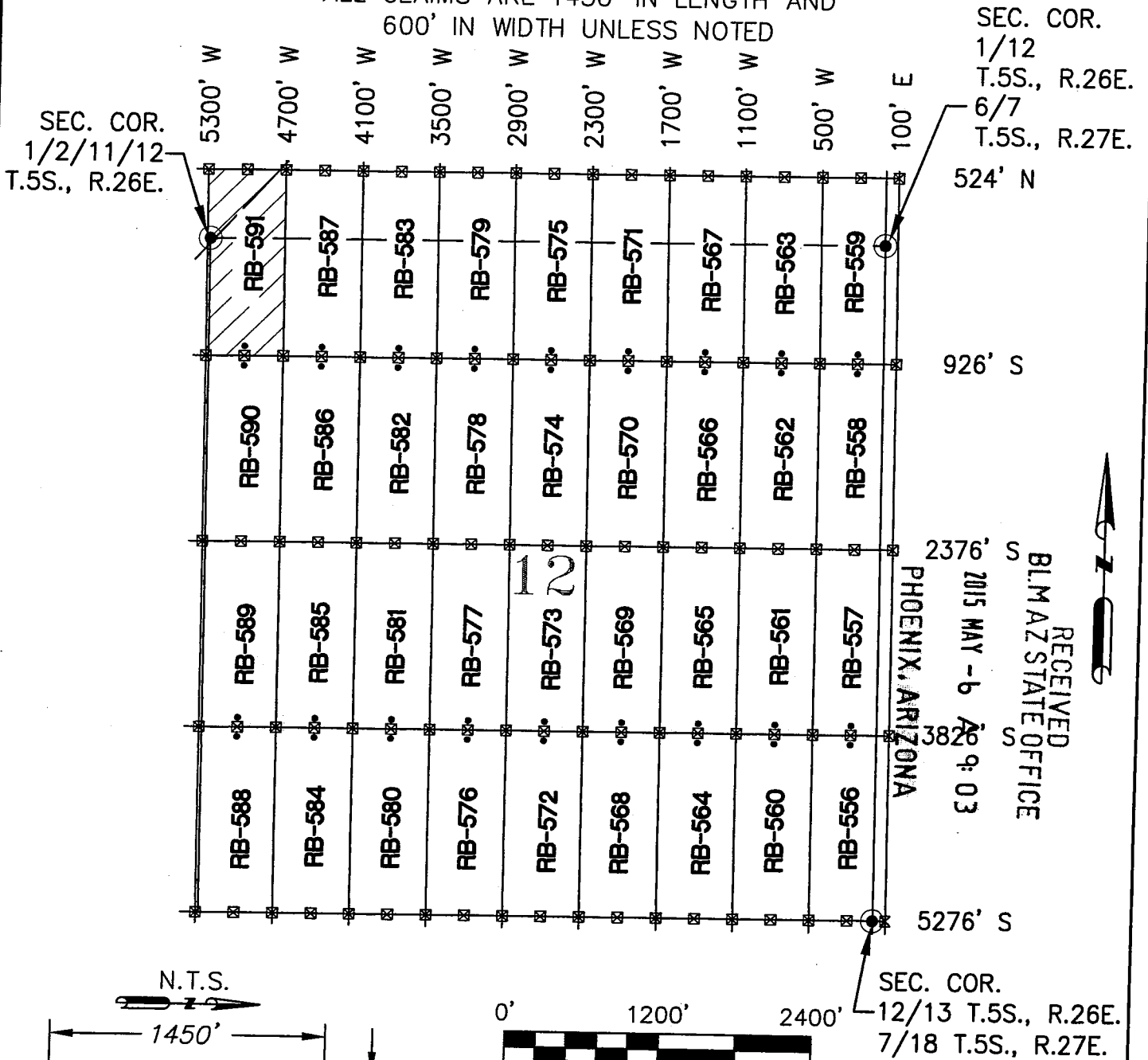

RECEIVED  
 BLM AZ STATE OFFICE  
 2015 MAY - 6  
 9:03 AM

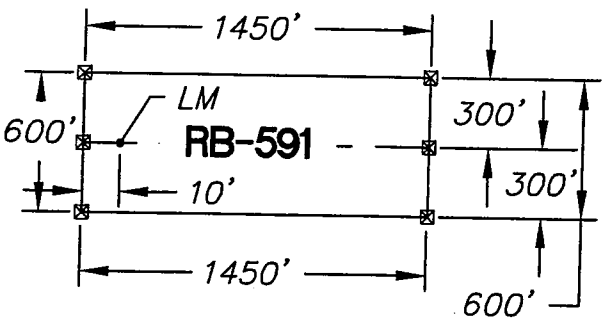

LOCATORS:  
 FREEPORT MINERALS CORP.  
 PO BOX 1019  
 SAFFORD AZ 85548

CLAIM ACREAGE = 20.0 AC  
 WC = WITNESS CORNER NORTH  
 OF SIDE LINE

**Entellus™**  
 2255 N. 44th Street Suite 125  
 Phoenix, AZ 85008.3279  
 Tel 602.244.2566  
 Fax 602.244.8947  
 Website: www.Entellus.com

DEPARTMENT OF INTERIOR  
BUREAU OF LAND MANAGEMENT

Input Parameters for Geographic Report with Land

System Id = CR

Admin State = AZ

Geo State =

Casetype Begins With

Case Disp Txt = AUTHORIZED, CANCELLED, EXPIRED, PENDING, REJECTED, RELINQUISHED, WITHDRAWN

Mer Twp Rng =

Section =

Mtrs = 14 0050S 0250E 013, 14 0050S 0250E 014, 14 0050S 0250E 023, 14 0050S 0250E 024, 14 0050S 0250E 025, 14 0050S 0250E 999, 14 0050S 0260E 001, 14 0050S 0260E 002, 14 0050S 0260E 011, 14 0050S 0260E 012, 14 0050S 0260E 013, 14 0050S 0260E 014, 14 0050S 0260E 036, 14 0050S 0260E 999, 14 0050S 0270E 006, 14 0050S 0270E 007, 14 0050S 0270E 018, 14 0050S 0270E 019, 14 0050S 0270E 030, 14 0050S 0270E 999

Commodity =

Commodity Txt =

Pending Org =

Pend Org Decode =

Total Rows Returned: 9

RUN TIME: 02:21 PM

UNITED STATES DEPARTMENT OF INTERIOR  
BUREAU OF LAND MANAGEMENT  
GEOGRAPHIC REPORT WITH LAND  
Sorted by Serial Number

RUN DATE: 05/18/2015  
Page 1 of 1

Adm State: AZ

Serial Number: AZA 027273  
Total Case Acres: 458.200

<u>Casetype</u>	<u>Case Disp</u>	14	0050S	0260E	<u>Sect</u>	<u>Sur Typ</u>	<u>Sur Num</u>	<u>Suff</u>	<u>Subdivision</u>	<u>Act Pend</u>
281007	AUTHORIZED				012	ALIQ			SESE;	
					013	ALIQ			NENE,SWNE,S2SW,NWSE;	
					014	ALIQ			SESE;	

Serial Number: AZA 027273  
Total Case Acres: 458.200

<u>Casetype</u>	<u>Case Disp</u>	14	0050S	0270E	<u>Sect</u>	<u>Sur Typ</u>	<u>Sur Num</u>	<u>Suff</u>	<u>Subdivision</u>	<u>Act Pend</u>
281007	AUTHORIZED				007	ALIQ			S2;	
					030	ALIQ			S2SE,NESW;	
						LOTS			2;	

Serial Number: AZA 028048  
Total Case Acres: 1.000

<u>Casetype</u>	<u>Case Disp</u>	14	0050S	0260E	<u>Sect</u>	<u>Sur Typ</u>	<u>Sur Num</u>	<u>Suff</u>	<u>Subdivision</u>	<u>Act Pend</u>
380913	AUTHORIZED				014	ALIQ			SW;	

Serial Number: AZA 032935FD  
Total Case Acres: 16,296.885

<u>Casetype</u>	<u>Case Disp</u>	14	0050S	0260E	<u>Sect</u>	<u>Sur Typ</u>	<u>Sur Num</u>	<u>Suff</u>	<u>Subdivision</u>	<u>Act Pend</u>
220100	AUTHORIZED				036	ALIQ			ALL;	

Serial Number: AZA 033365  
Total Case Acres: 30.690

<u>Casetype</u>	<u>Case Disp</u>	14	0050S	0270E	<u>Sect</u>	<u>Sur Typ</u>	<u>Sur Num</u>	<u>Suff</u>	<u>Subdivision</u>	<u>Act Pend</u>
281001	PENDING				018	ALIQ			NE;	







